A stylized human figure composed of white and yellow lines. The head is a simple circle with a green dot for a nose. The arms are horizontal lines. The legs are vertical lines. A yellow plant with two leaves grows from the chest area. The figure is set against a dark blue background with a network of white and yellow lines and dots.

EMBRACING  
SOCIETY 5.0  
WITH HUMANITY

Editor: Diah Karmiyati

 Bildung

Copy right ©2022  
All rights reserved

## Embracing Society 5.0 with Humanity

Editor : Diah Karmiyati  
Desain Sampul : Ruhtata  
Lay out/tata letak Isi : Tim Redaksi Bildung

Perpustakaan Nasional: Katalog Dalam Terbitan (KDT)  
Yogyakarta: CV. Bildung Nusantara, 2022

x + 1115 halaman; 15 x 23 cm  
ISBN: 978-623-6225-67-7  
Cetakan Pertama: Maret 2022

Penerbit:  
BILDUNG  
Jl. Raya Pleret KM 2  
Banguntapan Bantul Yogyakarta 55791  
Telepon: +6281227475754 (HP/WA)  
Email: [bildungpustakautama@gmail.com](mailto:bildungpustakautama@gmail.com)  
Website: [www.penerbitbildung.com](http://www.penerbitbildung.com) Anggota IKAPI

Bekerja sama dengan Direktorat Program Pascasarjana  
Universitas Muhammadiyah Malang

***Embracing Society 5.0  
with Humanity***

## ***Embracing Society 5.0 with Humanity***

Society 5.0 is a concept presented by the Japanese as a core concept of their economic system. They believed that technology should not surpass the intelligent of men. As such, in society 5.0 the Japanese government would like to ensure that all technological things are designed to be a human-centered design. In fact, their ministry of education in 2018 has also been readily prepared the future generation through a change in their education system. For example, the minister explains that in Japan, or many parts of the world, university entrance are divided into two main concentrations, which are science and social science. The minister thought of changing the system, as society 5.0 is about creating a technology that is human centered. For instance, they gave an example on designer babies. If, people from hard science learn about philosophy, ethics, and humanities, they won't face such ethical concern when developing a product. This is what is being envision by the Japanese government for their younger generation. Collaboration between science and social science is necessary to build a better environment for our future children. Another example is the companies in Japan, such as Hitachi and Fujitsu has already been implementing this 5.0 by designing product that relied fully on technology but puts human at its center (Hitachi, 2017).

Likewise, it is currently a hot topic in Indonesia. Indonesia as a country with the 4<sup>th</sup> largest population in the world has not been implemented this concept. Our country is still on the industry 4.0. Yet, with the rising interest in AI, Blockchain, NFT, number of unicorn start-up. and all recent technological changes, our country are ready to compete with any other countries in Southeast Asia. Society 5.0 is coming, and we need to embrace it. To prepare with the society 5.0, It is not only the technological side. It is necessary for us to have a strong principle at hearts that based on our belief system. We, as an Indonesian have known to be religious that most of us believed in God. We also commonly practice our religion and tend to be kind to people because we know God would love our good deeds. I personally think that this will help us to move forward and live together with advanced technology.

Technology begets a very important leap in human's life journey. It is important to keep valued of the benefit but it's more important to look out for the human itself. As its purpose is smarter than us, to help us, it will be very ideal if we embrace the technology using our ability to be kind.

Malang, 21 Maret 2022

**Diah Karmiyati**

## Daftar Isi

Market Potential of <i>Kafalah Bil Ujroh</i> Sharia Guaranteee Through E-Policy During the Covid-19 <i>A. Ifayani Haanurat, Ifadhila</i>	1
Development students character in 5.0 era through learning to write based on stories of the loves one <i>Abd. Rahman Rahim</i>	9
Higher Education and Human Resources Development for The Society 5.0 Era <i>Adri Efferi</i>	20
Pesticide Residual and Nutrition of Organic Cultivation Rice with Pumakkal and Conventional <i>Agus Sutanto, Hening Widowati, Achyani, Nendi Hendri, Feny Thresia, Eka Setyaningsih</i>	33
Social Capital in The Empowerment of Muslim Communities Face 5.0 Society <i>Agus Wahyu Triatmo</i>	40
Transformation Of Religiousity Of The Community At Wonolagi Gunung Kidul Yogyakarta <i>Ahmad Salim Novi Handayani</i>	49
Early Marriage Before and During Pandemic Covid-19 (Revolutionary Era of Society 5.0) <i>A'im Matun Nadhiroh</i>	57
E-Gov, Realization Of Anti Corruption Policy (long journey to Era Society 5.0) <i>Amalia Syauket</i>	66
Use of Voice Recognition of "Cake" Android-Based Application to Improve Student's Pronunciation <i>Amaluddin, Mutiah Nur Adzra, Siti Hajar Larekeng</i>	77

Combination of Curcumin and Honey as Supporting Therapy for Typhoid Fever in Children <i>Ami Febriza</i>	87
Employees Readiness Improvement Model to Face Changes in The Society 5.0 Era: Study On Indonesian Expatriates Abroad <i>Anggia Sari Lubis</i>	94
Features of Collaborative Writing in EFL Context <i>Ani Susanti</i>	103
The Hoax as Terror Communication: Threats and Challenges in Society 5.0 <i>Ari Sulistyanto, Hamida Syari Harahap, Wichitra Yasya</i>	112
Implementation of Human Resources in Sharia Capital Market Study Group During Covid-19 <i>Asri Jaya, A.Ifayani Haanurat, Nurlina, Nur'aeni</i>	121
Acts of Terrorism as a Crime Against Humanity Under International Law <i>Aulia Rosa Nasition</i>	127
Prophetic Legal Science Paradigm in The Era of Society 5.0 <i>Auliya Khasanofa</i>	137
IP Appraiser Role in The Implementation of Copyright as a Collateral in Indonesia <i>Cita Yustisia Serfiyani</i>	144
Indonesian Slangs in The Digital Communication <i>Dewi Kusumaningsih</i>	151
Students' Spatial Reasoning In Solving The Flat Shapes Problem <i>Dewi Risalah</i>	160
Industrial Revolution 4.0 and Society 5.0 Eras: From The Strategic Human Resource Management's Perspective <i>Dianawati Suryaningtyas</i>	165

The Online Learning Resources in Mastering Listening Comprehension: Students' and Teachers' Perspectives <i>Dodi Mulyadi</i>	173
Building Character Strengths through “new Islamic education” in Facing Era Society 5.0: Bibliometric reviews <i>Elihami, Kana Safrina, Riana Mashar, Hary Murcahyanto</i>	182
Ultraviolet Exposure To Energy Intake Synthesis Of Vitamin D <i>Emillia Devi Dwi Rianti</i>	194
Description Of Maternal-Fetal Attachment In Public Health Community Center Yogyakarta <i>Endang Koni Suryaningsih, Sri Subiyatun</i>	201
MSMEs Empowerment Strategy in Rural Areas Facing The Society ERA 5.0 <i>Endang Sungkawati</i>	208
Learning Assessment System in Islamic Higher Education <i>Enung Nugraha</i>	217
Midwifery Student Perception of Online Learning <i>Farida Kartini</i>	226
Implications of Constitutional Court Decision No. 91/PUU-XVIII/2020 on Working Relationship with PKWT Reviewed from Legal Certainty <i>Fithriatus Shalihah</i>	234
Dynamics Of The Digitalization Era For Women Umkm Activitiest <i>Hamida Syari H Ari Sulistyanto, Wichitra Yasa, Nita Komala Dewi</i>	243
Digital Marketing for Industrial Farming <i>Haris Hermawan</i>	252
Work Experience and Work Achievement Effect On Lecturer's Career <i>Hary Murcahyanto, Mohzana, Adri Efferi, Emilda Sulasmi, Koidah</i>	259

Development of Traditional Music Learning Media Using Macromedia Flash 8 <i>Hary Murcahyanto, Mohzana , Farida Sani</i>	273
Spices Removal Heavy Metal Pollutants, Increase CA and Protein in Foods <i>Hening Widowati, Agus Sutanto, Widya Sartika Sulistiani, Evita Anggereini, Maria Ulfah, Merri Sri Hartati, Asih Fitriana Dewi</i>	285
Teaching The Capita Selecta of Zoology Era 5.0 Based on the Surrounding Approach <i>Hening Widowati, Agus Sutanto, Widya Sartika Sulistiani, Evita Anggereini, Maria Ulfah, Merri Sri Hartati, Asih Fitriana Dewi</i>	307
Improved internal quality assurance system based on iso 9001:2008 with document management control (dmc) and web-based applications <i>Hermien Tridayanti Bayu Putra Airlangga</i>	325
Benefiting from Online Learning as a Shortcut to Address Society 5.0 Challenges: EFL Students' Perspective <i>Hersulastuti</i>	333
Bundes Services Can Improve the Community's Economy In Sharia Perspective <i>Heru Cahyono, Muh. Fahrurrozi, Nursaid</i>	344
Students' Critical Thinking In Solving Hots Problems: A Case Study In Gender Perspective <i>Ida Riskiana Dewi, Umy Zahroh</i>	359
Strengthening Pedagogical Competence of 21 <sup>st</sup> Century Teachers <i>Ifit Novita Sari</i>	368
Flipped Classroom Assisted by WhatsApp: Bridging Mathematics Learning During Pandemic and Era of Society 5.0 <i>Iis Holisin</i>	376
	387



Women Protection Against Sexual Violence Based On Human Security in The Era of 5.0 Society <i>Ika Dewi Sartika Saimima</i>	
A Mutualistic Talent Advantage In Teamwork Performance <i>Ika Nurul Qamari</i>	393
Corpus and Data-Driven Learning:Big Data for Language Teachers <i>Ikmi Nur Oktavianti</i>	402
Analysis of Leadership Style and Work Environment : The effect on employee Job Satisfaction <i>Irwan Idrus, Jumriani, Mutia Mursidiq Hasan</i>	413
The Architecture of <i>Banua tada</i> Buton, Southeast Sulawesi and its Challenges in the Future <i>Ishak Kadir, M. Husni Kotta</i>	420
Coping Strategy for the Defense of Persons with Disabilities During the Covid-19 Pandemic <i>Islamiyatur Rokhmah</i>	432
Prophets' Parenting Strategy Applied In The New Normal <i>Kana Safrina Rouzi</i>	436
Interconnection between Students' Cognitive Obstacles and Cognitive Load Theory in the Era of Society 5.0 <i>Kartinah</i>	447
From pandemics to business opportunities by young people: an opportunity and development <i>Kristina Sedyastuti</i>	456
Characteristics Of Lactic Acid Bacteria In Feces Of Mongoose ( <i>Paradoxurus Hermaphroditus</i> ) In District Jember <i>Kukuh Munandar</i>	463
Learning Geometry And Values From The Begalan Tradition: Ethnomatematic In Begalan Culture Of Banyumas, Indonesia <i>Kusno, Umy Zahrah, Reni Astuti, Muchtadi, Kusaeri, Triyono</i>	470

The Sustainability Of Maritime Eco-Lexicon Of Bungku Language In Morowali Regency <i>La Ino, Samsul and Maliudin</i>	483
Science And Interpretation Of The Qur'an In Indonesia Tracing The Scientific Interpretation Pattern In At-Tanwir Muhammadiyah's Tafsir <i>M Nurdin Zuhdi, M. Anwar Nawawi</i>	493
Locally Community Institutional Sustainability in Environmental Isolation Faced Pandemic becomes Endemic <i>Maharani, Marlinda Irwanti, Anita Ristianingrum</i>	501
Development of Teaching Materials Based On Mathematical Reasoning To Improve Mathematical Ability <i>Maifalinda Fatra, Lilis Marina Angraini</i>	522
Telenursing in Schizophrenia <i>Mamnuaah, Noorwahyu Trihidayati</i>	531
Practice speaking and social interaction for mentally retarded children through fantasy stories and role playing <i>Marwiah</i>	539
Antibiofilm Activity of Honey in Multispecies Pathogen <i>Masfufatun, Lusiani Tjandra, Budhi Setiawan</i>	562
Mother as Mother: Welcoming the Society Era of 5.0 <i>Mohd. Nasir</i>	576
Development of Audio Visual Media Based on Macro Media Flash 8 on Dayang-Dayang Dance Learning <i>Mohzana , Hary Murcahyanto , Linda Laili Harjuni</i>	584
Leadership And Principal Work Motivation Influence On School Operator Performance <i>Mohzana, Hary Murcahyanto, Adri Efferi, Emilda Sulasmi, Koidah</i>	596

Teacher Decision Making: Strategies to Give Examples Through Posing and Solving Mathematical Problems <i>Muchtadi</i>	613
Sharia Marketing Era of Industrial Revolution 4.0 in Improving Customer Loyalty <i>Muh. Fahrurrozi, Heru Cahyono, Nursaid</i>	623
Intelligent Transportation Management System (ITMS) in Indonesia Towards Society 5.0 <i>Muh. Nashir T</i>	634
Family Education during the Covid-19 Pandemic: Efforts to Build Parent-Child Attachment <i>Muhammad Abrar Parinduri</i>	643
Implementation of Digital Marketing as Integrated Marketing Strategy for Small and Medium Business Products in Palopo City <i>Muhammad Aqsa, M. Risal</i>	659
Sustainable Development 4.0 in Indonesia: eTOURISM, eMOBILITY, eCITIES and eDESA <i>Muhammad Ikhsan Setiawan, I Nyoman Sudapet, Agus Sukoco, Ronny Durrotun Nasihien, Che Zalina Zulkifli and Mohd Idrus Mohd Masirin</i>	668
Management of Science Learning in the Era of Society 5.0 in Indonesia <i>Muhammad Minan Chusni</i>	683
Culture Freedom to Learn Based on the Philosophy of the Indonesian Nation in Entrepreneurship Courses in the Era of Society 5.0 <i>Nanis Hairunisya</i>	690
Development of Children's Basic Movement Skills <i>Nevi Hardika</i>	699
Implementation of Quality-Based Islamic Worldviews Competitiveness in Industry 4.0 and Era of Society 5.0 <i>Novi Indriyani Sitepu</i>	708
	716

Disease Perception And Its Relation To Quality Of Life Of Undergoing Haemodialysis Patients <i>Nur Chayati, Nur Aini Handayani</i>	
Reconstruction of agent-based model in predicting the risk of stock On Indonesian Stock Exchange (BEI) <i>Nursaid, Heru Cahyono, Muh. Fahrurrozi</i>	727
How to Increase Customer Satisfaction Based on Service Quality, Brand, And Trust in Cafe Customers? <i>Nurul Qomariah, Wekel Mega Wisesa</i>	739
Revitalization of Islamic Religious Education Readiness Facing Era 5.0 <i>Nurzannah</i>	758
Gender Digital Divide and Empowering Women in the Industrial Age 5.0 <i>Oktiva Anggraini</i>	768
Practicing Communication, Collaboration, Critical Thinking and Creative Thinking Skills in Learning <i>Peni Suharti</i>	777
Utilization Of <i>Canva</i> In Learning To Write Poetry As A Learning Source In The Era Society 5.0 <i>Purwati Zisca Diana</i>	786
Postmethod Era and Its Implication to Language Teacher's Education <i>Purwo Haryono</i>	796
The Existence of Religion, Scripture, and Islamic Thinkers in the Era 5.0 <i>Rafiudin</i>	804
Realization of Online Learning in the Perception of Junior High School Student <i>Rizka Harfiani</i>	812
Indonesia In Society 5.0 ; Impact On Legal Policy <i>Rizka</i>	822

The Implementation of the Teaching and Learning Model of the Value Clarification Technique in Society Era 5.0 <i>Ronggo Warsito, Dhiva Maulida Rizqi Nur'Aini</i>	832
Telepsychology: Alternative Digital Mental Health Services Towards The Society Era 5.0 <i>Rr. Setyawati</i>	841
Blended Learning in Islamic Education Learning: Moderate Learning Model in Society 5.0 Ruslan, Luthfiyah	853
Framing English Language Teacher in Facing Society 5.0: Challenges and Adaptive Strategy <i>Salasiah Ammade, Khairil</i>	861
Vocational High School Learning In Era 5.0 <i>Singgih Prastawa</i>	871
The contribution of science in building society 5.0 <i>Siti Patonah</i>	865
Building Student Character In Writing Poetry Based On Makassar Local Wisdom In The Era Of Society 5.0 <i>Siti Suwadah Rimang</i>	897
Early Detection Services Development For The Indonesian Ethnic Group Specified In The Community Era 5.0 <i>Sri Lestari Utami</i>	899
The Impacts Of Industry 4.0 And Society 5.0 To The Sovereignty Of States Based On International Law Perspective <i>Sri Wartini</i>	911
Strengthening Financing Reform For Msmes In The Society Era 5.0 <i>Sriyono</i>	921
Science Education: Its Role in Building Scientific Attitudes in The Context of Society 5.0 Era <i>Suciati</i>	931

The Implementation of Pop Culture as Teaching English Media in Society 5.0 <i>Sudiran</i>	941
Characteristics of Learning Facing the Era of Society 5.0 <i>Sulastrri Rini Rindrayani</i>	949
Prevention and Control of Non-Communicable Diseases Era Society 5.0 <i>Sulistyaningsih</i>	958
Fuzzy Logic Oftimization Implementation For Optimizing Motor Speed On Barrel Machine <i>Sumardi Sadi</i>	968
Agriculture Based on Biochemistry and Information Systems in Era 5.0 <i>Suryani</i>	982
<i>Problem Based Learning</i> Model Integrated With Islamic Values <i>Sutrisni Andayani</i>	994
Development of Mathematical Learning Media Integrated Qur'an <i>Syarifah Fadillah, Yadi Ardiawan, Rahman Haryadi</i>	1003
Literacy Program in Madrasah: Challenging Lagging <i>Taufiqur Rahman, Moh. Zamili</i>	1012
EFL Teaching Innovations in Indonesia <i>Tono Suwartono, Retno Ayu Cahyaningtyas</i>	1021
Blended Learning Strategy During the COVID-19 Pandemic in Plant Tissue Culture Course <i>Trianik Widyaningrum</i>	1036
The Approach to Stunting Problems in the Society 5.0 Era <i>Wa Ode Salma</i>	1044
Environment with Technology as Highly Important Element for The Wellbeing of the Elderly <i>Wantonoro, Moh Ali Imron</i>	1053

Social Media Use during the Covid-19 Pandemic and Beyond: A Uses and Gratifications Perspective <i>Wichitra Yasya, Nani Nurani Muksin</i>	1061
The Implication Of Project-Based Teaching On Undergraduate Students' Creativity <i>Wiwin Sri Hidayati</i>	1071
Implementation Of E-Learning In Integrated Islamic Junior High School Granada Tangerang City <i>Yessi Astriani, Asrori Mukhtarom</i>	1086
Bibliometric Analysis Of Digital Marketing And Halal Cosmetics <i>Yulist Rima Fiandari</i>	1092
The challenge of building critical thinking in Era 5.0 <i>Zahara Tussoleha Rony</i>	1101
Creative Industries in The New Normal Era: The Role of Digital Marketing <i>Zakiyah Zahara, Muslimin</i>	1109

# Market Potential of *Kafalah Bil Ujroh Sharia* Guarantee Through E-Policy During the Covid-19

A. Ifayani Haanurat<sup>1</sup>, Ifadhila<sup>2</sup>

## Introduction

Corona Virus Disease 19 (Covid-19) is a pandemic or one of the outbreaks reported by the World Health Organization (WHO) in early 2020, with the fast transmission. The existence of this global pandemic has triggered a global economic recession in 2020, and this event is worse when compared to the era of the 1930s. Even the International Monetary Fund (IMF) and the World Bank predicted this to the end of the first quarter of 2020 the global economy will enter a sharply corrected recession. And also global economic growth slumped to negative 2.8% or dragged up to 6% from the previous global economic growth, even though the initial projection estimated that at the end of the first quarter of 2020 the growth percentage was around 3% [1], [2].

The Covid-19 pandemic in 2020 was a quite tough year in the economic field because the consequences were not only health problems and the number of people who fell but greatly affected the economic growth of several countries including Indonesia [3]. One of the government's policies in suppressing the Covid-19 virus is to limit people's mobility. The policy issued by the government in handling Covid-19 was based on calculations of economic conditions, social conditions and political conditions in Indonesia, also based on experiences that occurred in other countries, namely the implementation of the lockdown rules, then PSBB (Large-Scale Social Restrictions), which was followed by PPKM rules (Implementation of Community Activity Restrictions) especially in areas with high transmission rates (red zones), as well as encouraging the community to change behaviour to 3M rules (wearing masks, keeping distance and washing hands) by strengthening the implementation of 3T or *testing, tracing, treatment* [4].

In addition, companies are required to carry out the Covid-19 protocol starting with the implementation of WFH (Work From Home) to New Normal WFO (Work From Office) [5], with the impact of covid-19 which caused panic in the financial sector which also

---

<sup>1</sup> Universitas Muhammadiyah, Makassar, [ifayani.haanurat@unismuh.ac.id](mailto:ifayani.haanurat@unismuh.ac.id)

<sup>2</sup> Universitas Muhammadiyah, Makassar, [ifa\\_hanurat@yahoo.com](mailto:ifa_hanurat@yahoo.com)



affected Indonesia [6], and requires companies to create and innovate to maintain its continuity.

One of the financial sectors that have experienced a direct impact from the COVID-19 pandemic is the Insurance Industry. Although the Covid-19 pandemic had a direct impact, the insurance industry sector in Indonesia was able to survive. Even the Indonesia Financial Group (IFG) is optimistic that the insurance industry's growth potential is still large, and IFG as a BUMN (State-Owned Enterprise) holding insurance, guarantee and investment believes that the insurance industry has promising prospects in line with the ongoing national economic recovery (PEN) and globally in 2021 from the implementation of Covid-19 vaccination activities in the community, [7].

Opportunities in the Islamic insurance industry sector during the COVID-19 pandemic has positive momentum in maximizing services, namely by maximizing the use of digital technology. There is double disruption, namely a shift in work due to digitization or automation that was accelerated by the Covid-19 pandemic. Digital technology in the insurance sector that is developing is E-policy (electronic policy), but when compared to Japan, the use of e-policy in Indonesia is relatively slow because Japan has implemented it since 2005 for policyholder registration as well as for claim services, thereby reducing direct contact with a customer. In addition, the use of e-policy can provide convenience for customers and industrial efficiency, namely more efficient paper and transportation costs [8].

In the last five years, the sharia insurance industry recorded encouraging growth, but in the first quarter of 2020, the assets of the sharia insurance industry decreased by 3.30% compared to 2019, from the position in April 2019 of Rp 42.8 trillion to Rp 41.4 trillion in April 2020 [9]. So, the Covid-19 pandemic has also had an impact on the asset growth of the sharia insurance industry, but the interesting thing is that one of the sharia insurance companies, namely Askrimdo Syariah Financing Guarantee (JPAS), shows that its asset position has increased by 32.20% from the previous year (2019) of Rp. 951.79 billion to Rp. 1.26 trillion in 2020. And the growth of the *kafalah bil ujroh*, which increased in 2020, which was 34.13% or equivalent to Rp. 41.08 billion compared to the realization in 2019, [10]. Based on this fact, the aspect that got attention to be studied more deeply is how to maximize the potential of the *sharia kafalah bil ujroh* guarantee market during the Covid-19 pandemic, with the object of the study of Askrimdo sharia Financing Guarantee (JPAS) because it is a sharia guarantee insurance that shows growth performance during the COVID-19 pandemic.

## Discussion

*Kafalah* is understood as a guarantee agreement given by one party to another where the guarantor is responsible for the repayment of a debt which is the right of the guarantee recipient. That is, *kafalah* is a transfer of responsibility for someone who is guaranteed by holding on to the responsibility of another person as a guarantor, [11]. So, the meaning of *kafalah bil ujroh* or *kafalah* contract is an agreement to provide guarantees given by the insurer (*kafi'il*) to a third party (*makful lahu*) to fulfil the obligations of the second party or the borne party (*makful anhu*) [12].

Askrindo Syariah Financing Guarantee (JPAS) is a sharia financing insurance which in its operational activities uses a *kafalah* contract or *kafalah bil ujroh*. And is a financing guarantee insurance that first utilizes information technology in its business by producing an electronic policy or e-policy. E-policy is an insurance policy document in the electronic form issued to customers containing a contract agreement, [8]. Even since 2015 e-policy has been used but in implementation, it is still not well socialized.

In addition, it is also the first sharia financing guarantee company in Indonesia which from the beginning became the market leader and since 2015 has controlled a national market share of 63% and has been supported by an integrated Information Technology Online System, and became the first financing guarantee insurance using E-policy. under the name OSA (Online System Application) which provides easy service to customers and business partners. As well as offering a variety of bundling products with IT-based services [13].

Online System Application JPAS, which is a web page that contains applications to assist the acceptance process for online financing guarantees that can be done directly by partner banks. OSA allows business partners to accept financing guarantees online. OSA is also equipped with general *ujrah* simulation features, submission of *ta'widh* (claims) processes, providing up-to-date information on the amount of insurance that has been classified according to a class of business (CoB), direct printing of policies in the form of electronic policies (e-policies), and information about the validity period of a policy.

The use of e-policy is very supportive and makes it easy for JPAS partners, especially in administration, namely by including the Qrcode, making it easier to provide, search and prove the validity of

the JPAS certificate. In addition to operational cost efficiency, it is also time-efficient because e-policy issuance can be sent in the form of soft files, (Putri, 2017). Other benefits and advantages are providing a competitive advantage with fast service and assisting in sharpening market strategy, and product branding.

Although the socialization carried out by JPAS has not been carried out continuously and programmed in each branch and has not been intensely carried out on *makful lahu* (the bank), this is very necessary because the business concept of JPAS is business to business or B2B. The B2B or business to business principle refers to business conducted between companies, not between companies and individual consumers, [14]. So in this case, the bank needs to be managed so that it can better understand JPAS products and be able to explain them to its customers, therefore it is necessary to intensively and programmatically carry out socialization of sharpening the benefits of each product.

In addition, JPAS needs to pay attention closely to the *kafalah bil ujroh* rate used while still taking into account the rate used by competitors and paying more attention to technical and non-technical factors to support the marketing sector. Synergy with brokers and agents as well as business partners of banking institutions and non-bank institutions is very much needed, taking into account the characteristics of each region in each branch, and if you look at the guarantee market conditions during this pandemic, you can focus more on strategies to the health product financing insurance sector. and telecommunications and food processing, by increasing the scope of cooperation partners.

The application of e-policy in its business strategy can give more meaning to the use of the B2B business model, because it has advantages that other business models cannot, such as the opportunity to create sales that continue to grow and add orders in line with customer business growth. The marketing strategy that needs to be set in the B2B model, namely a) Clarify the goals and targets to be achieved; b) Customer and market focus; c) Channels and marketing tools; d) Customer Relationship Management or CRM, [14], [15].

A CRM system is a tool needed by the marketing team to formulate a marketing strategy based on customer data that they currently have. In addition to being used for related purposes or ease of follow-up, CRM makes it easy for the marketing team to find a match between marketing methods and the majority of customers obtained from that marketing, [14], [15].

To maximize the potential of the sharia *kafalah bil ujah* guarantee market through e-policy by adjusting market share to be able to in line with the digital era, JPAS should be able to innovate by adopting the CRM system used by its parent company, namely Askrindo, which is conventionally based which has determined its business marketing strategy based on customer data in 2020 by implementing the CRM and AIR (Askrindo Internal Rating) applications, which aim for Direct Business up to 20% and the Management can monitor all company sales activities from prospect to end, and CRM is integrated with the Underwriting application, namely AIR.

CRM is useful for recording the history of customers or prospective insureds, and benefits for prospective insureds themselves, namely updating information more quickly and transparently, this is also related to efforts to improve service to customers, [15], [16], [17]. CRM is integrated with the Underwriting application, namely the Askrindo Internal Rating (AIR) application. The CRM application is a sales tool that has been embedded in every gadget or smartphone marketer to increase marketing effectiveness. With these two applications, services to the insured or prospective insured become faster, accountable and transparent.

In line with digital insurance, the application of the AIR application, which is used by underwriters or analysts as a customer rating and risk rating tool, can speed up the Service Level Agreement (SLA) in accepting or closing insurance. SLA itself is a standard for the duration of work that must be done with overall business objectives, the faster the time is completed, the faster the policy issuance which has an impact on the better reputation of the insurance company and increased policy productivity. In the Credit Insurance Industry, the conventional Askrindo system is the first company to implement the Rating System application. The AIR application greatly facilitates the analysis process both at the Branch Office and at the Head Office. For underwriters, the analysis process can be faster and the quality of insurance coverage is better because it uses standard parameters carried out by the scoring engine and is measured according to each business field. Thus, the risk mitigation process and the application of the precautionary principle can be maintained properly. On the other hand, the insured or prospective insured will get the policy faster.

With the use of digitalization during the COVID-19 pandemic, JPAS can also innovate and further sharpen the use of the concept of e-marketing strategy, and content marketing, where the benefits of using e-marketing according to [18], [14], [19], [16] are:

- a. Being able to reach a wide range of consumers in an environment that has not been met by competitors.
- b. The target is consumers who were divided into groups and then developed a continuous dialogue.
- c. Electronic transactions and low fees.
- d. E-mail and data files can be transferred to selected customers or all customers in seconds.
- e. The sales process path is direct from the producer to the user without having to go through the classic distribution channels.
- f. Being able to add products to market quickly and make changes to sales plans very quickly.
- g. Being able to track sales activities that have occurred, the steps and the results obtained.
- h. Being able to keep an eye on competitors
- i. Creating a dialogue between companies and consumers
- j. Being able to distribute programs and information about products via E-mail or file transfer.

## **Conclusion**

In difficult times due to the pandemic, JPAS has a strong commitment to continue to enlarge its role as a Sharia-Based Guarantee Institution. And throughout 2020, it continues to improve strategic partnerships with partners and stakeholders and reach 50 partners, as well as strengthen the capabilities of the resources as a foundation to Continue to Grow and Develop in the New Normal Era. In terms of performance, JPAS has experienced growth, which can be seen from the kafalah income which increased by 34.13% or equivalent to Rp. 41.08 billion, compared to the fact in 2019 of Rp. 120.38 billion and increased in 2020 by Rp. 161.46 billion. Its asset position increased by 32.20% from the previous year (2019) of Rp. 951.79 billion to Rp. 1.26 trillion in 2020. The company's strategy during the covid-19 pandemic is to participate in supporting the national economic recovery (PEN), improving and utilizing IT-based services, as well as human resource development, where the IT system uses the COBIT 4.1 standard which consists of 4 domains, namely Plan & Organize (Planning), Acquire & Implement (Development), Deliver & Support (Operations), Monitor & Evaluate (Supervision)

## **Reference**

- [1] W. Liu, X. G. Yue, and P. B. Tchounwou, "Response to the COVID-19 Epidemic: The Chinese Experience and Implications for Other Countries. International journal of environmental research and

- public health," *Int. J. Environ. Res. Public Health*, vol. 17, no. 07, 2020.
- [2] R. M. Carrillo-Larco and M. Castillo-Cara, "Using country-level variables to classify countries according to the number of confirmed COVID-19 cases: An unsupervised machine learning approach," *Wellcome Open Res.*, vol. 5, 2020, DOI: 10.12688/wellcomeopenres.15819.3.
  - [3] S. Indayani and B. Hartono, "Analisis Pengangguran dan Pertumbuhan Ekonomi sebagai Akibat Pandemi Covid-19," *J. Ekon. Manaj. Univ. Bina Sarana Informatika*, vol. 18, no. 2, 2020.
  - [4] T. G. Abdul Basith Bardan, "Jokowi Resmi Mengumumkan PPKM Darurat, Ini Perbedaannya Dengan PSBB dan PPKM Mikro," *insight kontan*, 2021. <https://insight.kontan.co.id/news/jokowi-resmi-mengumumkan-ppkm-darurat-ini-perbedaannya-dengan-psbb-dan-ppkm-mikro>.
  - [5] A. Praghlapati, "New Normal 'Indonesia' After Covid-19 Pandemic," vol. 2019, pp. 1-6, 2020, DOI: 10.31234/osf.io/7snqb.
  - [6] I. Effendi and P. H. RS, "Dampak Covid 19 Terhadap Bank Syariah," *Ekon. J. Ilmu Ekon. dan Stud. Pembang.*, vol. 20, no. 2, pp. 221-230, 2020.
  - [7] I. F. Group, "Menilik Dampak Pandemi pada Industri Asuransi dan Prospeknya," *Indonesia Financial Group*, 2021. <https://ifg.id/id/blog/menilik-dampak-pandemi-pada-industri-asuransi-dan-prospeknya>.
  - [8] V. K. Ika Putri, B. Winarno, and A. R. Budiono, "TINJAUAN YURIDIS TERHADAP POLIS ELEKTRONIK DALAM PERJANJIAN ASURANSI," *Syariah J. Huk. dan Pemikir.*, vol. 17, no. 1, 2017, doi: 10.18592/sy.v16i1.2007.
  - [9] Kominfo, "Tingkatkan Pengembangan Industri Asuransi Syariah di Tengah Pandemi," *kominfo*, 2021. <https://www.kominfo.go.id/content/detail/27534/tingkatkan-pengembangan-industri-asuransi-syariah-di-tengah-pandemi/0/berita>.
  - [10] A. Syariah and A. R. A. Syariah, "Tetap Tumbuh dan Berkembang di Masa New Normal," 2020.
  - [11] M. S. Antonio, *Bank Syariah: dari teori ke praktik*. Gema Insani, 2001.
  - [12] J. W. Wicaksono, "Dinar : Jurnal Prodi Ekonomi Syari'ah," *E-Jurnal.Stail.Ac.Id*, vol. 2, pp. 21-66, 2018, [Online]. Available: <http://e-jurnal.stail.ac.id/index.php/dinar/article/view/126>.
  - [13] Askrimdo Syariah and A. R. A. Syariah, "Pertumbuhan Berkelanjutan Bersama Mitra," 2019.

- [14] C. Bălan, "Dave CHAFFEY, digital business and E-commerce management: Strategy, implementation and practice," *Management and Marketing*, vol. 9, no. 3. 2014.
- [15] J. P. Wildyaksanjani and D. Sugiana, "Strategi Customer Relationship Management (CRM) PT Angkasa Pura II (Persero)," *J. Kaji. Komun.*, vol. 6, no. 1, 2018, doi: 10.24198/jkk.v6i1.8754.
- [16] D. Hendarsyah, "E-Commerce Di Era Industri 4.0 Dan Society 5.0," *IQTISHADUNA J. Ilm. Ekon. Kita*, vol. 8, no. 2, 2019, doi: 10.46367/iqtishaduna.v8i2.170.
- [17] Wahdian and S. D. Setiawati, "Customer Relationship Management Pt. Samsung Electronics Indonesia Di Tengah Pandemi Covid-19 Di Indonesia," *Linimasa J. Ilmu Komun.*, vol. 3, no. 2, 2020.
- [18] A. Zimmerman and J. Blythe, *Business to business marketing management: A global perspective*, second edition. 2013.
- [19] P. Kotler and K. L. Keller, "Manajemen pemasaran edisi 13 jilid 2," 2021.

# **Development Students Character in 5.0 Era Through Learning To Write Based On Stories Of The Loves One**

Abd. Rahman Rahim

## **Introduction**

Writing skill is one aspect of language skill. In general, writing skills are acquired by a person through formal schools. As one aspect of language skills, writing skills must be trained from an early age (basic education bench) so that students can express their written ideas in a cohesive and coherent manner. If the nature of learning writing skills is internalized, the teacher should adopt the notion that teaching students to write is like training a chess player. Students are not sufficiently introduced to the functions of each chess child and reliable chess playing theory, but students must be directly involved in experiencing the problems they face in playing chess, accompanied by the knowledge and experience of the trainer. Therefore, students should be given the maximum opportunity to be emotionally involved in the whole process of learning to write [1].

Today, serious improvements are needed in learning writing skills. Although it is understood that many factors influence students' inability to write, it is recognized that the teacher's role is very decisive. The reality today is that learning writing skills that are widely applied in schools is a traditional approach, namely how to teach students to write directly by giving a certain title, theme, or topic. Students are asked to develop an outline with an emphasis on aspects of the written result.

Linguists position writing skills at the highest level in the process of language acquisition and learning. This happens because writing skills are productive skills that can only be obtained after listening, speaking and reading skills. This also causes writing skills to be the most difficult language skills. It is not surprising that there is often behavior from people who say that in general, students are not able to express ideas or ideas in written form [5].

The facts above indicate that nowadays serious improvements are needed in learning writing skills. The use of learning media is one of the efforts that can be done to improve the achievement of learning objectives. "The stories of loved ones as a guiding medium in learning writing skills can be used as an alternative solution. The media is very well applied in learning writing skills as a first step in guiding students to express ideas, ideas, imagination, and the results of their observations.



Several previous studies on writing that are relevant to this research, namely Increasing Writing Ability Using the Suggestopedia Method for Students of the Indonesian Language Education Study Program, Faculty of Teacher Training and Education, Bengkulu University [3]. Furthermore, Improving the Quality of Writing Learning through the Application of the Process Approach in Grade V of Elementary School. [4]. In addition to this research, other research on writing, such as, Efforts to Improve Ability to Write Observational Report Texts through the Application of Problem Based Learning Learning Models for Class X Tipl 1 Vocational Students of South Sumatra State Vocational School [5]. In addition, the study entitled Development of Learning Media for Writing Explanatory Texts Based on Mindmap Applications for Class VIII Students of SMP Negeri 33 Palembang [6]. Furthermore, specific research on writing a description entitled Structure and Linguistic Elements of Description Text of Class VII Students of SMP Negeri 30 Padang [8]

As a teacher, it is appropriate if you always create and innovate in carrying out teaching tasks as your responsibility. Teachers should not be fixated on media forms or approaches that have been patented or standardized. On the other hand, teachers must innovate more in delivering students to achieve learning goals optimally [8]. The update obtained by applying this media is because students write something they know. The biggest difficulty of a writer is not having an idea or not knowing what to write [9] So far, students are only sent to write something that is far from the reach of their thinking so that students can only guess. On the other hand, by using simple but effective media, students will understand and master the material they have written. Students can tell longer stories about the figures of people who are close to them so that they practice their ability to think critically, which is to express something that is already in their understanding area.

Based on the description above, the author has developed an alternative writing learning strategy, namely 'media stories of loved ones'. This media emphasizes the process by trying to provide direct experience for students to understand, study, explore, and analyze the problems that will be written. This of course will provide a learning experience that can stimulate the scientific mind and critical attitude of students because it is designed with an in-depth activity process so that the learning process is more meaningful. With such a process, students will experience and feel the problems that will be written so that it is more meaningful than simply being offered themes and frameworks to be developed [2].

It is very important for teachers to implement the story of Orang - Orang Beloved media in teaching and learning Indonesian, for example basic competencies that contain inspirational story texts. The interesting thing about the Story of People - People Loved media is that it maximizes the implementation of Indonesian language learning activities so that it has an impact on increasing the ability of students to understand the learning process well. In using the story of the Loved Ones media, Indonesian language teachers design interesting learning activities and follow the steps or stages in their implementation [1].

## **Discussions**

Teaching Indonesian is directed at students' mastery of the four aspects of language skills, namely listening, speaking, reading, and writing skills. This is what requires teachers to be more careful in conveying explanations to students regarding the use of appropriate language. Teaching Indonesian based on the 2013 Curriculum is carried out with a scientific approach. Two basic things that distinguish the 2013 Curriculum from the previous curriculum are the steps or stages of the scientific approach (observing, questioning, reasoning, trying, and forming networks) and authentic assessment. It is intended that Indonesian language learning is oriented towards mastering the Indonesian language as a communication tool, not only providing linguistic knowledge and language skills, but also providing attitudes to fellow humans and divine attitudes.

In the 2013 curriculum, it is known as Core Competence 1 (human attitude), Core Competency 2 (divine attitude), Core Competence 3 (knowledge), Core Competence 4 (skills). This scientific approach in learning Indonesian is carried out on a text-based basis which is realized through themes that have relevance to the lives of students, usually used as a means of practicing reading, listening, writing, and speaking. Thus, the concept of integration in Indonesian language learning in essence achieves the target of mastery of literacy, which is better known by being skilled at speaking Indonesian properly and correctly. Thus, language skills are very important in the learning process [3].

The general pattern of teaching activities is the interaction between teachers and students. Teachers who create a good learning environment will fulfill the learning interests of students. Students are learning subjects who enter the learning atmosphere created by the teacher. Therefore, teachers try to influence students' learning styles and ways [12].

In teaching and learning activities, students need something that allows them to communicate well with teachers, friends, and with their environment. Therefore, in the teaching and learning process there are two things that determine success, namely the setting of the teaching and learning process and the teaching itself, both of which have a dependence on creating situations.

Writing skills by language teaching experts are placed at the highest level in the language acquisition process. This is because writing skills are productive skills that can only be obtained after listening skills, speaking skills, and reading skills. This also causes writing skills to be the most difficult language skills. Although writing skills are difficult, their role in human life is very important. Writing activities can be found in everyday human activities, such as writing letters, reports, books, articles, and so on. It can be said that human life is almost inseparable from writing activities [6].

### **Inspirational Text Story**

Inspirational story texts are texts that contain fictional stories or real experiences that can inspire and inspire someone. Inspirational stories are stories from the past that can inspire someone to do the same, especially regarding success. Inspirational stories will be able to give influence in the form of enthusiasm and strength to do something. Inspirational story texts are written by authors based on facts, observations, and results of investigations of these facts. Therefore, in the text of the inspirational story there are expressions that reflect the attitude of sympathy, concern, empathy, and other personal feelings towards the contents of the story.

In every story, both fiction and non-fiction, there is content in the form of wisdom or mandate that the author wants to convey. For him, stories are the right medium to convey complaints, hopes, opinions, or messages, including the values of life that are beneficial to humans. Values are things that are useful for humanity and perfect human nature, such as moral values, cultural values, social values, religious values, educational values, and so on.

Moral values are values related to morals or character. Cultural value is something related to customs or habits in people's lives. Social value is something related to norms in social life. Religious or religious value is something related to worship activities, beliefs, or elements of God. Educational values, namely values related to changing behavior from bad behavior to good behavior through the teaching process [9].

The following inspirational story text builds on its structure:  
Inspirational story text structure : is an introduction to the story.

Orientation	Usually found at the beginning which contains an introduction to the character or a description of the situation
Complication	: is a conflict that occurs in a story
Resolution	: : conflict resolution contains events that occur in a story
Koda	: is the closing of the story containing the conclusions messages contained in the story. Usually the code is at the end Story of Loved Ones as Media Learning

The presence of inspirational stories in classroom learning can be referred to as learning media or as teaching aids. Given the presence of stories of loved ones can facilitate communication between teachers and students. The stories of loved ones that are presented as learning media in the classroom, of course, must be related to the concept of learning. Its presence can function as apperception and motivation. In the context of the inspirational story being used as a material study, it means that the appearance is related to the learning objectives [5].

Inspirational stories that are shown in the form of writing and videos in learning can generate motivation for students. The advantages of inspirational stories as learning are that inspirational stories can also generate productive motivation, and also get inspirational motivation in the form of changes in thought patterns, attitudes and behaviors that are useful in life.

Inspirational stories are stories from the past that can inspire someone to do the same, especially regarding the success and success of a character. In an inspirational story, people who listen will get moral lessons in the hope of being able to instill them in their daily lives. Inspirational stories will be able to provide an important influence on a person's behavior in the form of enthusiasm and strength to do something, so that people who listen will be motivated to do the same.

Motivation means encouragement that causes students to be excited to take an action. Learning motivation means the encouragement experienced by students to be eager to learn. In the

context of classroom learning, motivational activities are very important in order to achieve optimal learning outcomes.

If the teacher is able to generate students' learning motivation, then they can face a pleasant learning situation. Students are active in the learning process, there are almost no disturbances in the course of learning, and will achieve optimal results. On the other hand, if the teacher is not able to generate students' learning motivation, they will face learning situations that are tiring, passive, and often interfere with the course of learning, so that the results will not be optimal [4].

Related to this description, Erti [12]. said that "motivation is one of the most important prerequisites in learning". Motivation can arise intrinsically and extrinsically. Intrinsic motivation is the desire to act caused by driving factors from within students. The indicator of a student having good intrinsic motivation in learning, he will show an attitude of perseverance in learning and a good spirit. Extrinsic motivation is a driving factor from outside a person, for example praise from others, awards, or prizes. A teacher can generate motivation to his students

### **The Nature of Loved Ones Story**

The learning method is a set of assumptions that are interconnected and related to the nature of learning. An approach is axiomatic and describes the nature and characteristics of a subject being taught. In terms of learning methods, the psychological background and pedagogical background of the choice of learning methods to be used are described. In terms of the learning approach, experts who develop the concept through psychological and pedagogical studies seek to reach agreement with practitioners and observers of learning about the proper way to teach [12].

To optimize the process and learning outcomes, it must be designed in such a way that all aspects included in it can support the learning objectives that have been determined. Designing learning using the media "Stories of Loved Ones" basically uses generally accepted design principles. This strategy tries to stimulate the creative process of students in applying the basic knowledge of the language they have through the activity of writing simple paragraphs about people who are close to their hearts to be communicated to others. Thus, the core of the design presented in this paper is concerned with the preparation of media to guide student activities by using the media "Stories of Loved Ones" and maintaining the relevance of the overall learning design.

The principle of applying the “Tales of Loved People” media is to offer an opportunity that is conducive to writing narrative discourse about people who are close to students' hearts. The object of writing is deliberately chosen by loved ones to attract their interest, and make writing activities something fun. Thus the object of writing like this is expected so that writing activities are no longer considered a burden by students.

The design of learning by using the media "the story of the Loved Ones" indirectly trains students in doing detailed descriptions to express something either based on observation or just the result of imagination. A skill that must be possessed by students in an effort to make them critical of an object. As for how to design a student activity guide using the media "Stories of Loved Ones" are as follows :

### **1. Setting Goals**

Goals are the core of all learning activities. If the learning objectives are not clear, then the learning process will be in vain. Therefore, whatever is done in a lesson must be designed in such a way that it always refers to the goals to be achieved. To determine the learning objectives with the media "Stories of Loved Ones" it must first be inventoried language skills and what aspects of needs that can be covered therein. After that, it is also necessary to determine which skills and aspects of needs can be included in additional objectives which are in addition to the main goal [8].

### **2. Designing Student Activity Guide**

After the teacher sets the learning objectives, the next activity is to design a student activity guide by fulfilling the following conditions:

- a. Each student identifies one person he or she loves and many things are known about him or her. For that, students must prepare photos or pictures of loved ones with stories about them.
- b. The object of writing starts from people who are close to the hearts of students, then gradually to other objects provided that the objects must be people who are admired by students.
- c. The number of lines in the initial writing should be fewer, for example only five lines and then increased according to the interests and attitudes of students towards learning.
- d. The choice of words and titles used in the initial writing must be simple and then gradually they use diction, titles, meanings that are more precise and interesting.
- e. The best writing in each learning meeting is announced and given confirmation.
- f. After all learning is completed (as planned), the student's

writing is determined or bound and then stored in the library.

### **Learning Assessment**

The assessment in this learning is carried out in aspects, namely the assessment of the learning process and the assessment of learning outcomes.

#### **Assessment of the learning process**

Assessment of the learning process is carried out during the learning process. The things that are assessed in the learning process are student enthusiasm, speed, completing assignments, activeness, and critical attitude. These four aspects are considered to be able to provide information about whether or not the use of the "Kisah Orang Beloved" media is appropriate as an alternative learning. It is acknowledged that there may still be many aspects that have not been covered but are sufficient to make the assessment valid [6].

#### **Assessment of learning outcomes**

After the learning process is carried out several times, the next step is the assessment of learning outcomes. Learning outcomes are assessed based on the story assessment indicators proposed namely content, structure, vocabulary, language, and mechanics. Learning with the media "The Story of Loved Ones" is said to be successful if there is an increase in the quality of students. The indicator of this increase can be seen from the increase in the value obtained by students based on predetermined criteria.

Each learning method has specific characteristics including advantages and limitations for use in certain learning situations or settings. The term design means the whole, structure, framework or outline, and the sequence or systematic of activities. In addition, the word design can also be interpreted as a systematic planning process carried out before the development or implementation of an activity. This is done to design the training process so that it becomes an effective, efficient, and interesting activity [7]. In other words, learning design is a process carried out to analyze learning needs and objectives as well as developing a learning material delivery system to achieve learning objectives.

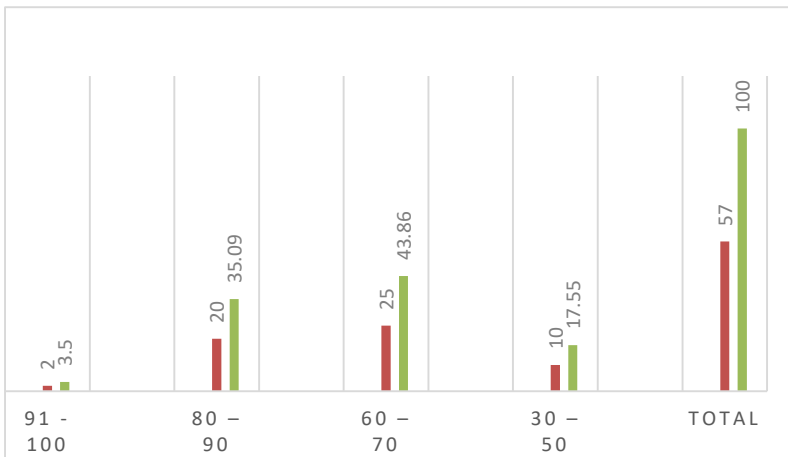
Learning design usually starts from analytical activities that are used to describe learning problems. After being able to determine the real problem, the next step is to determine alternative solutions that will be used to overcome learning problems.

Designers of learning programs need to determine the right solution from the various alternatives. Next, apply these solutions to

overcome the problems at hand. Evaluation is the next step needed to assess whether the solution chosen and implemented can play an effective role in overcoming the problem [2].

The results of the learning design that contains a systematic and comprehensive design of an activity or learning process. The design can be applied to overcome the problems encountered in learning activities. To create an effective student activity, a good design planning process is needed. One of them is the Story of Loved Ones, more focused on planning for use in actual student situations in the classroom. This learning system design model looks simpler when compared to other learning system design models. However, it has a tremendous impact in the learning process, because it can make students active during the learning process. Especially Indonesian lessons. The graphs and tables below are evidence of student learning outcomes after being given the material to write inspiring story texts through the use of the story of the Loved Ones media.

**Chart 1 Level of Students Understanding**



Understanding students' achievements based on intervals, categories, frequencies, and percentages, can be seen in the table below:

**Table 4 The Level of Students' Understanding of Inspiring Story Text Materials**

Interval	Category	Frequency	Percentage
91 -100	Very High	2	3,50
80 - 90	High	20	35,09



60 - 70	Medium	25	43,86
30 - 50	Low	10	17,55
Total		57	100

Students' understanding of the inspirational story text learning material using the story of the Loved Ones media. First, students in the very high category, obtained an interval value of 91-100 as many as 2 people or 3.50%. Second, students in the high category obtained an interval score of 80-90 as many as 20 people or 35.09%. Third, students in the medium category, obtained an interval value of 60-70 as many as 25 people or 43.86%. Fourth, students in the low category, obtained an interval value of 30-50 as many as 10 people or 17.55%. This shows that the achievement of student learning outcomes is stated. Thus, students' understanding of the inspirational story text material is stated to be adequate [1].

Furthermore, the activity carried out by the teacher is to see the activity of students when the activity takes place. Attendance is also important to support the implementation of these activities. The application of the story of the beloved people is carried out in six stages. 'that is, the teacher tries to motivate students in learning. Second, the teacher does pacing, namely the teacher equates the position, gestures, language, and brain waves with the students so that the explanation can be understood easily. Third, the teacher does Leading, which is directing students to do something. Fourth, the teacher uses positive words to direct students to think positively on any given information. Fifth, the teacher gives praise as a reward for improving student learning outcomes so that students can be motivated. Sixth, the teacher gives examples of inspiring story texts through consistent speech and behavior so that students can understand based on these examples.

### **Conclusion**

Based on the data found, it is clear that the hypothesis proposed in this study, namely "Students have adequate learning outcomes if 75% get a score of 65 or more is declared accepted. The results of this study indicate that learning Indonesian with the media of the Story of the Loved Ones can improve the ability of students to learn, especially studying inspirational story texts.

The application of the story of the story of the beloved person is carried out in several steps, namely intention and motivation, pacing, leading, using positive words, giving praise, and modeling. The success in applying the story of the Loved Ones media can be seen in the observation activities carried out. Observation activities are

carried out in stages, both at the beginning of the activity and at the end of the activity. Therefore, observation can be a measure of success in the application of the Story of the Loved People media

## References

- [1] Abidin, Yunus. 2013. Pembelajaran Bahasa Berbasis Pendidikan Karakter. Bandung: Refika Aditama.
- [2] Harera, Adrias. 2000. Menjadi Manusia Pembelajar. Jakarta: Penerbit Harian Kompas.
- [3] Jarwanto, 2015. Pemanfaatan Kisah Inspiratif Untuk Meningkatkan Motivasi dan Pemahaman Mendeskripsikan Pranata dan Penyimpangan Sosial Pada Siswa Kelas VIIIA SMP Negeri 3 Saradan Tahun 2015 (online) <http://jurnalbioma.blogspot.com/2015/12/pemanfaatan-kisah-inspiratif-untuk.html>. diakses 23 Januari 2021
- [4] Kartika Utami, Endang. 2020. Peningkatan Keterampilan Menulis Teks Cerita Inspiratif Melalui Strategi Pemodelan. Jurnal Karya Ilmiah Guru(online)file:///E:/Downloads/171-Article%20Text-554-1-10820201102%20(2).pdf diakses 25 Februari 2021
- [5] Mahsun. 2014. Teks dalam Pembelajaran Bahasa Indonesia Kurikulum 2013. Jakarta: Raja Grafindo Persada.
- [6] Nafi'ah, Siti Anisatun. 2018. Model-Model Pembelajaran Bahasa Indonesia diSD/MI. Yogyakarta:Ar-Ruzz Media.
- [7] Pribadi, Benny A. 2009. Model Desain Sistem Pembelajaran, Langkah Penting Merancang Kegiatan Pembelajaran yang Efektif dan Berkualitas. Jakarta: Dian Rakyat.
- [8] Priyatni, Endah Tri. 2014. Desain Pembelajaran Bahasa Indonesia dalam Kurikulum 2013. Jakarta: Bumi Aksara.
- [9] Rahim, Abd. Rahman. 2021. Cara Praktis Penulisan Karya Ilmiah. Yogyakarta: Zahir Publishing.
- [10] Sugiyono. 2009. Metode Penelitian Kuantitatif Kualitatif dan R&D. Bandung: Alfabeta.
- [11] Sunendar, Dadang dan Iskandar Wassid. 2009. Strategi Pembelajaran Bahasa. Bandung: PT. Remaja Rosdakarya.
- [12] Suyono dan Hariyanto. 2014. Belajar dan Pembelajaran, Teori dan Konsep Dasar. Bandung: PT Remaj

# **Higher Education and Human Resources Development for the Society 5.0 Era**

Adri Efferi

## **Introduction**

Education is long life needs. Every human being needs education, regardless of time and place. Education is very important, because without human education it will be difficult to develop and even be retarded. Education must really be directed to produce quality human beings who are able to compete, and have noble character and good morals. Education takes place from the most basic level to the highest level.

Through education we prepare reliable human resources and become the backbone of the nation. With the spirit of being an Indonesian nation, everyone will be moved to work in their respective fields. A teacher will teach students attention, attitudes, and skills so that they become better human resources. Technocrats and economists also develop science or science and technology so that Indonesian people can shift their position from countries that originally adopted technology to become technology developing countries.

Many people think that the problems faced by the Indonesian people are caused by the low quality of Indonesian human resources. Both academically and non-academicly, not all Indonesian people can participate in contributing their potential, both physical and non-physical potentials in carrying out development according to their respective expertise and fields. For this reason, community participation in development is very important and necessary. This is because the success of development can only be achieved if the community actively participates in all development activities. Only with the high quality of human resources can the problems of the Indonesian nation gradually be resolved properly.

Assessing the quality of a nation's human resources in general can be seen from the quality of the nation's education. Therefore, in the process of improving human resources, education plays a very important role and must be an integrated process with the process of improving the quality of human resources itself. One of the important roles of education, from elementary to tertiary level, is to prepare quality human resources in accordance with the changing times so that there is no gap between reality and ideals.

## **Discussion**

### **College Functions**

According to Djokopranoto & Indrajit, (2004) higher education is an activity in an effort to produce educated people. Meanwhile, in accordance with Government Regulation of the Republic of Indonesia Number 60 of 1999 concerning Higher Education, the objectives of higher education are:

Prepare students to become members of the community who have academic and or professional abilities who can apply, develop and or enrich the repertoire of science, technology and or the arts. Develop and disseminate science, technology and or art and seek their use to improve the standard of living of the people and enrich the national culture.

The development and progress of a nation is largely determined by the extent to which human resources master science and technology to be utilized for the welfare and prosperity of the nation. An institution that is relevant and responsible for producing superior and quality human resources who master science and technology is a university. Higher education as a center of excellence should be able to produce quality human resources to face the era of globalization which is full of challenges and quality or quality competition. The level of progress of the nation is largely determined by the progress and development of higher education institutions. However, one thing we cannot ignore is that the progress and quality of higher education is largely determined by graduates from MA/SMA, MTs/SMP, and MI/SD as inputs or raw materials for these universities. Therefore, improving the quality of education must comprehensively cover all levels of education.

In various literatures, universities actually have three functions that must be carried out. *First*, the function of human resource development, *second*, the function of knowledge and technology, and third, the function of change in society. These three functions of higher education must be fully understood by the managers and the academic community of higher education.

The first function of higher education is to build human resources. In fact, the implementation of education both at the elementary, secondary, and higher education levels are all aimed at building the human resources needed by a nation. A nation will survive if it has quality human resources, especially knowledge and skills. This knowledge and ability is built through education, including higher education. Therefore, every higher education must carry out its function as a developer of human resources.

If it is associated with the economic field, universities must be able to develop aspects of capital related to human beings, so that the wheels of the economy can grow in a nation. Even if there is an economic crisis on a global scale, the nation will be able to survive these economic shocks. On the other hand, if a nation does not have or prepare its human capital as well as possible, especially in this era of globalization, economic growth will stagnate.

The second function is to develop science or science and technology. The development of science or science and technology in some universities is sometimes forgotten or not noticed. So far, the development of science and technology at several universities has only focused on carrying out learning activities for students, but related to the activities of conducting various research efforts as research development efforts have not been widely carried out. Even if someone has done it, it cannot be said to be optimal, in fact it tends to be just a mere formality. The various development research that will be carried out, of course, must not go out of the corridor of developing science and technology in various fields at the university concerned.

In accordance with its meaning, science is a collection of theories and processes that are built on empirical facts, then formulated in a statement that can function later. The scientific theories that have been built are not only descriptive but also predictive and control. An understanding of science as mentioned above, perhaps will find common ground if in its application level it is also based on the religious paradigm, because there is no conflict between science and religion (especially Islam). The rationale is that when science will be applied, we will think about the norms and values that will be developed. For example about nuclear technology, even though there is no conflict with religion. But when it will be applied, the question will arise for what nuclear technology is? If you want to fight, kill, or destroy other people, of course it is very contrary to religious values, but if it is for welfare, such as power generation facilities, it will certainly be a good deed.

Returning to the importance of a university conducting development research, in addition to the needs of the university itself, it is also hoped that universities that have a high production level will produce superior and quality human beings as researchers with relevant and useful research results. In addition, it also supports partnerships between universities as research institutions and various sectors of life such as the industrial or trade sectors as important elements in national development.

This is what should be the future vision of a university, to prepare reliable human beings, not only in the learning process they do, but also have careful planning in the learning and research process. In essence, research in various fields of science and technology must always be encouraged by a university, in an effort to produce quality alumni and at the same time increase their competitiveness, both among domestic universities, gratefully able to compete with universities abroad.

The third function of higher education is to make changes in society, towards a better direction, not vice versa, even worse. Universities are expected to be able to manage, control, engineer, improve and reconstruct society. Social order, social behavior, and social change are endeavored to remain based on the philosophy of life that exists in society.

For the community, an assessment of a university is not only seen from the building walls that look tall and beautiful, but the extent to which the university is able to provide positive impacts on the changes caused by its activities in society. It's not enough to stop there, the changes enjoyed by the community are not limited to those around the college campus, they should be able to extend to regional and national levels, even internationally, so that from being just an agent of change, it becomes an agent of change. a leader in change (leader of change). This is one indicator of the significance of a university that can make people survive, in the face of various life challenges that are changing and getting tougher every day.

### **The Role of Universities**

From the three functions of higher education as described at length above, then what we call the role of higher education emerges. These roles are known as the Tridharma (three services) of higher education, the three of which are integrated with each other. The tridharma includes: first, education and teaching, second, research and third, service.

The first tridharma of higher education is education and teaching. This role becomes the foundation in the implementation of a university, because it is more directed to the development of human resources. One of the indicators of the quality of education and teaching is related to semester credit units (SKS). SKS is the weight given to each course which shows how many meetings were held, how many tasks had to be done by students and lecturers, how many efforts were made by students and lecturers in improving themselves through face-to-face activities. advance, self-study and do assignments. For example, one course weighs 3 credits with a time

unit of 50 minutes. This means that students must attend lectures 3 times 50 minutes, times 14 meetings (12 lectures), 1 Mid-Semester Examination (UTS) and 1 Semester Final Examination (UAS) in one semester. Plus 3 times 50 minutes of doing assignments from the lecturer, plus 3 times 50 minutes of doing assignments or self-study. If students carry out the SKS well, it will produce students with quality learning outcomes. However, this success will be achieved if the lecturers do their job well. Lecturers must come to class 3 times 50 minutes 14 times meeting to interact with students. Lecturers also need careful preparations to give their teaching. Then the lecturer must check all the assignments of students and return them to students, so that it is known whether the work carried out by the students is right or wrong. In addition, lecturers are also required to always read at least 3 times 50 minutes. Thus the lecture materials that will be taught to students will always be up to date.

Lecturers are an important parameter in the process of controlling higher education institutions because of their very central position, placing lecturers as the main human resources holding key operational tasks and responsibilities of higher education institutions. With professional skills and close relationships with students and peers, lecturers greatly determine the development of the institution, influencing the intellectual and social environment of campus life. Therefore, all efforts made with the aim of improving the performance of lecturers as teaching staff in universities in a comprehensive manner need to be carried out so that their functions and roles can be carried out optimally in order to achieve organizational goals.

Although it has been implemented, the lecturer professionalism development program in Indonesia has not shown encouraging results. Several state universities in Indonesia are already included in the list of the best universities in the world, even though they are still ranked number one. Likewise with the private sector, there are a number of private universities whose quality is reliable and on par with universities abroad.

Data held by the Research and Development Department of the National Education Ministry shows that of the 120,000 permanent lecturers at private universities and state universities in Indonesia, there are still 50.65 percent or around 60,000 of whom have not received a master's degree or just a bachelor's degree. According to other data, the total number of lecturers at PTN is 240,000 people, 50% of whom do not have the educational qualifications equivalent to a master's degree. Of these, only 15% of lecturers have doctoral degrees. When compared to universities in Malaysia, Singapore and the Philippines, where the number of doctorates has reached more

than 60%, it appears that lecturers at Indonesian universities are still far behind.

Law No. 14 of 2005 concerning Teachers and Lecturers requires university lecturers to have at least a master's degree. The law states that primary and secondary education educators are required to have at least a bachelor's degree. Meanwhile, to educate at the undergraduate level of academic education, at least have a bachelor's degree (S2), while for postgraduate programs are doctorates (S3) and professors.

This fact is ironic considering that one of the great aspirations of universities in Indonesia is to become a world class university. With 50% of lecturers who are still qualified for S1, it will be difficult in the near future to achieve these goals. Moreover, in the midst of such conditions, there is no significant effort from the lecturers to improve their professionalism as the main element of higher education. Some of them are even less aware that the teaching profession, like other professions, is also related to the dimensions of knowledge, expertise, and ethics that need to be continuously developed. Unfortunately, these dimensions are not paid much attention to by the lecturers, so it is not surprising that the spotlight and criticism continue to be addressed to them.

Among the criticisms that are often raised regarding the quality of university lecturers in Indonesia are: First, currently the interest of some lecturers to continue reading and conducting scientific research in their scientific field has decreased. They seem to be satisfied with the doctorate or Ph.D they have achieved. They are no longer busy with scientific research which is their main task to contribute new things in their scientific field. Even if they do a research, usually it is not meant to discover new things or contribute something that is beneficial to society, but to gain promotion or achieve a professorship position.

The results of research by Djokopranoto & Indrajit, (2004) from FKIP, University of Muhammadiyah Surakarta, which were published in the journal *Cakrawala Pendidikan*, November 2010, Th. XXIX, No. 3 states that, based on data at the PTS Research Institute in the Surakarta area, the average number of research titles proposed by lecturers in one year ranges from 10%-20% of the number of lecturers at the PTS concerned.

Second, not a few lecturers think that their main task is only to convey knowledge or assign scientific research to students. They often forget that they are educators in the broadest sense. On their shoulders they carry a responsibility that goes beyond the walls of the campus, namely to educate students, both in terms of science,



mentality, way of thinking, behavior, and so on. But sometimes it is very unfortunate that there are some unscrupulous lecturers who are far from being role models for their students. As written in TEMPO Interaktif Bandung, dated February 11, 2010 regarding the disclosure of a plagiarism case that befell a Professor of the Department of International Relations, Parahyangan University, Bandung. Even worse, as written by tabloidjubi.com on July 3, 2010 about the phenomenon of free sex between lecturers and students in Papua. Even though there are cases of plagiarism, free sex is carried out by a few individuals, whose numbers are not proportional to the number of lecturers who are still consistent with their duties, but it cannot be denied that the behavior of these individuals has tarnished the teaching profession.

Third, many lecturers avoid their main duties as educators in various ways to cover their shortcomings. For example, by applying "scientific despotism" because they are unable to overcome critical dialogue with students, running away from the main topic of the lecture to pass time because they do not master the material, or giving assignments and then letting students argue on their own with the excuse of training them to discuss, and so on. An example of an attitude of avoiding assignments can also be manifested in the lack of face-to-face meetings done in class. The results of Ambarwati's research published in the maxi journal in 2009 showed that the presence of lecturers in the teaching and learning process at one of the universities in Ambon city showed that the number of face-to-face meetings that should have been at least 18 times per semester was only filled with an average of 11 meetings.

According to the results of Sumardjoko's, (2010) research as quoted above, judging from the attendance data of lecturers in class, it can be said that the quality is not too bad because the average attendance of lecturers in class is 70% of the standard set. In fact, for private universities that already have a quality assurance institution, the attendance rate for lecturers in the class can reach 90%.

Some of the conditions above are very likely to occur because among the lecturers there are still various weaknesses. According to Buchari, (2003) the problems encountered among lecturers are: Lack of reference for lecture materials, Foreign language skills are very low, Placement that does not match the required qualifications. Lecturers who are placed come from various social classes, regions, ethnicities, ages, behaviors that blend into one academic community so that unwanted access may occur if each cannot adjust well.

This condition shows that there is still a wide gap between the ideals and the real conditions of university lecturers in Indonesia

today. This condition is of course influenced by various factors, such as education management, economy, social reality, and others. Therefore, to fix it also requires a comprehensive lecturer professionalism development program that involves various parties, ranging from universities, government, to the community.

Lecturers are an important component in improving the quality of education. This has been confirmed in the Law of the Republic of Indonesia Number 20 of 2003 concerning the National Education System Article 35 paragraph 3, that to achieve the quality of education standards it is not only determined by the elements of the education staff, namely lecturers, but also how the university is managed based on content standards, processes, graduate competencies, facilities and infrastructure, management, financing, and evaluation of education that can be implemented by a standardization, assurance and quality control body for education.

In the Law of the Republic of Indonesia Number 14 of 2005 concerning Teachers and Lecturers, article 1 paragraph 2 states that, "Lecturers are professional educators and scientists with the main task of transforming, developing, and disseminating science, technology and art through education, research and community service". The position of lecturers as professionals has the function of increasing the dignity and role of lecturers as agents of learning, developers of science, technology, and the arts, and serving the community to improve the quality of national education.

Lecturers at universities have a strategic role in terms of academic and student development. Lecturers are professionals who determine what is best for their students based on professional considerations. Many acknowledgments state that the development of the quality of education can be pursued through the development of the quality of lecturers. This can be seen from the findings of previous research that in education applies "the man behind the system" [4], humans are the key factors that determine the strength of education. In fact, education as a service industry is a "front line provider and determine the quality of service delivery system", lecturers are at the forefront in determining service quality [5]. Higher education that is innovative, quality, and responsive to global developments and local challenges, its success lies in its development and development efforts. The main drivers of growth, namely university lecturers.

Theoretically, many factors can influence the role of lecturers. According to [6] states that the factors that influence individual behavior are effort, ability, and environmental situation. The tridharma of the two universities is research, the content of which is more related to the development of science and technology. Research

is considered as a tool to develop science and technology. Education and research conducted by lecturers and students are directed at developing cooperative abilities, ways of thinking and working actively and creatively, and not to be left behind, must be carried out continuously, so that they have a contribution to changes that occur in society towards a better direction and are based on values. - high value.

The third tridharma of higher education is service, namely activities carried out by the academic community such as lecturers and students in community development so that changes occur for the better, both for the short, medium, or long term based on the knowledge gained from education and teaching. and research results. Even though the product of a university is community-oriented, a principle that must be adhered to is not only to give fish, but also to prepare the hook. For this reason, activities that are community development or social engineering need to be increased in intensity. The purpose of this activity is to empower the community to be able to stand on their own, which is facilitated by the university. Universities must really show their role actively by carrying out activities to build a good society.

The coaching efforts carried out by a university, of course, should never be outside the disciplines developed at the university. For example, universities that work in the field of religion, it is certain that the concentration of community development carried out is related to religion as well. Even though it is possible to establish inter-institutional work relationships, then also conduct coaching in terms of entrepreneurship, but its nature is only as an addition, the main focus remains on the religious field.

The three functions and roles of higher education institutions that have been described above have interrelationships between one another. If one function or role is lame, let alone all three, it will be difficult for the university to be qualified, not to mention if the target is able to compete, it will certainly be even more difficult. One more thing, the existence of the function and role of higher education is associated with the existence of a larger education system. This means that all people involved in the administration of higher education, from leaders, lecturers to administrative staff, must always be directed to improve the quality of education in their minds.

The function and role of higher education as an educational institution must also be able to guarantee the provision of quality services to its students. Quality services are services that provide satisfaction to stakeholders. Satisfaction is not only felt by students,

but also parents or the community who perceive students as quality resources.

Universities or lecturers in providing services, in order to maintain quality, require an audit of the performance carried out, including assessments made by students on the quality of lecturers in delivering teaching. This assessment is needed to find out the shortcomings or weaknesses in providing lecture materials to be used as material to improve and develop better abilities with lecture materials that are always up to date. The assessment of these students is usually objective because they experience direct learning from the lecturer, whether it is satisfactory or unsatisfactory.

Judging from the context, the functions and roles of higher education apply at a general or universal level. Anyone, be it individuals, communities, or the state, in organizing higher education institutions must be aware of the function of higher education institutions.

Indicators of educational progress, including higher education in Islamic institutions, cover a wide range of standards, both national and global. If you use a national standard reference, then there are eight standards. First, the standard of content, which shows whether the content of education in educational institutions meets the expectations of society or not, or is it just a formality. Second, process standards, make sure that the learning process that occurs in educational institutions meets and achieves the objectives of the learning process. If not fulfilled then the learning process needs to be improved. Third, the competency standards of graduates. Fourth, educators. Fifth, the standard of facilities and infrastructure. Sixth, management standards. Seventh, financing standards and Eighth, education assessment standards. These standards are used as a measure to assess the progress of an educational institution in a certain period of time. Therefore, the views of educational institutions must be oriented forward, in order to achieve what is desired and needed.

Today is the era of quality or quality, if a university is able to produce quality graduates, it is certain that the community will take into account, both at the national and international levels. On the other hand, if it is not qualified, it will be ignored by the community. Therefore, everyone who is involved in an educational process at a higher education institution must always have a commitment to provide assurance that the educational process that will be or is being implemented at a higher education institution is of high quality. The slogan for realizing quality education is of course not only in the form of lip service, but can actually be realized. In essence, to realize the

quality of education, it is necessary to have a deep understanding of the quality of an educational institution, including the quality of higher education.

Higher education is one of the media for the government to provide services to the nation's children. Therefore, there is nothing wrong if the governance or management is largely regulated by the central government, including financing. Although recently, there has been a tendency for the government to want to hand over the management of higher education to each institution (campus autonomy), but with the rise of several cases that tend to be detrimental (expensive tuition fees, unclear admission selection processes, etc.), when At this time, the government began to take over the management authority again.

As additional information, the Education Legal Entity (BHP) and the State-Owned Legal Entity (BHMN), which have been implemented by the government for several universities, aim to provide flexibility in governance, institutional management, and human resource management. Every university must have a map of the strengths, weaknesses, and needs needed. Everything is stated in the SPM (Minimum Service Standard). The growth of students every year needs to be made a study program. Data on students and the number of graduates need to be made so that the ratio of lecturers and students is balanced. But unfortunately, a good plan is not necessarily at the level of application in the field, will reap good results as well. This has also happened with several universities that have tried to implement the BHP and BHMN model management systems.

### **Building a Development Strategy for the Age of Society 5.0**

Strategy is a comprehensive plan that integrates all resources and capabilities that have a long-term goal to achieve a goal. Meanwhile, strategic management is a continuous, iterative and cross-functional process that aims to ensure that educational institutions are able to adapt to the dynamics of existing changes. So that universities can move quickly and correctly, it is necessary to be able to determine a new position with a new paradigm and orientation called repositioning. Higher education repositioning is carried out by assessing and reviewing all strengths and weaknesses so that it can determine which ones must be improved and strengthened.

There are several steps that can be applied, including:

- a. Creating trust and confidence for higher education stakeholders.  
This development strategy is very important for universities, because it is a form of university public and social accountability. Among the development steps to create user trust and confidence

in tertiary institutions can be in the form of: building physical facilities, having a sufficient number of permanent lecturers, both in terms of quantity and quality, providing the required number of laboratories, modern libraries, sports facilities, arts and religious development centers. in the form of a mosque which is not only functioned as a place of worship but also as a place of study and deepening of Islamic and social insight.

b. Build competitive advance centers.

By building centers of excellence in the academic and entrepreneurial fields, it will build a brand image in the community. Some examples of excellent centers that can be developed by universities such as those owned by the University of Muhammadiyah Malang (UMM) include: Center for Biotechnology Development, Internet Production Unit, Integrated Motorcycle Workshop, Foreign Language Course, Auto Cad Training Centre, Cisco Academy can be used by academics to develop themselves in real life in society.

c. Developing ICT (Information and Communication Technology)

By building and developing ICT used in teaching and learning processes, management and interaction between units in Higher Education. The development of the ICT community on campus is balanced with the development of adequate IT infrastructure such as connections using fiber optics, free Hot spot services for students, and others.

d. Build professionalism, guarantee quality and maintain good relations with stakeholders.

Higher Education as an educational organization has an interest in preserving culture, values, independence and business. Therefore, universities are required to keep up with the times (fashionable). Education concerns the dimensions of the system, paradigm and culture. Higher education culture needs to be adapted to the world's paradigm shift, which is customer-oriented, customer satisfaction, management openness, and quality assurance. Education quality assurance (quality assurance) is the meeting point between the expectations of service users (clients) and education service providers (providers). The quality of education is something that is always discussed by education experts. For different communities, the definition of education quality may be different, as well as the indicators used to measure the quality of education. Quality Assurance as a quality measurement tool has been implemented in education in several developed countries as a form of accountability for professional standards in the field of education. A well-planned and systematic Quality Assurance will

be used for self-reflection, monitoring educational performance, providing a comprehensive picture of the effectiveness of the educational process and university performance, university sustainable improvement, and can be used to provide assurance or trust that an educational product or service is said to be of high quality.

e. Build cooperation with other institutions.

Building partnerships with other institutions is something that cannot be avoided. Due to the rapid development of information technology in this era of globalization, the world will feel smaller because distance is no longer an obstacle in communicating. With communication, geographical limitations seem to disappear and become a unified global community.

The steps in preparing Indonesian Human Resources (HR) above, of course there must be intervention from various parties. In preparing superior human resources and competing in the era of Society 5.0, it will be difficult if you only rely on educational institutions. Elements of the community and stakeholders must be involved in it starting from the central and local governments, non-profit organizations, and the community.

Indonesian human resources must improve their quality and always carry out innovations, thus giving birth to various creations that contribute to the progress of the environment and society in general. Nowadays, innovation is a necessity, so the adage innovate or die.

## References

- [1] R. Djokopranoto and R. E. Indrajit, *Manajemen Perguruan Tinggi Modern*. 2004.
- [2] B. Sumardjoko, "Faktor-Faktor Determinan Peran Dosen Dalam Penjaminan Mutu Perguruan Tinggi," *J. Cakrawala Pendidik.*, vol. 3, no. 3, pp. 294–310, 2010, doi: 10.21831/cp.v3i3.359.
- [3] A. Buchari, *Pemasaran Stratejik Jasa Pendidikan*. Bandung: Alfabeta. 2003.
- [4] Miller, ""Appraising Institutional Performance". Improving Academic Management. USA: John Wiley and Sons,," 1980.
- [5] E. Sallis, *Total Quality Management in Education*. London: Kogan Page Limited. 2002.
- [6] Sopiah, *Sopiah. Perilaku Organisasional*. Yogyakarta: Andi Offset. 2008.

# **Pesticide Residual and Nutrition of Organic Cultivation Rice with Pumakkal and Conventional**

Agus Sutanto<sup>3</sup>, Hening Widowati, Achyani, Nendi Hendri, Feny Thresia, Eka Setyaningsih

## **Introduction**

Indonesia is a tropical country with a staple food in the form of rice. The majority of people's livelihoods are in rice farming. In farming, people usually use fertilizers and pesticides to increase agricultural yields. The use of pesticide in widespread have potential effect on public health. Farmers depend on pesticide to control pests and other diseases [1]. Continuous and uncontrolled use of chemicals also has the potential to damage rice nutrition. Organic rice cultivation using Pumakkal organic fertilizer was tested for three harvests, providing an opportunity for environmentally friendly cultivation compared to conventional cultivation using chemical fertilizers and pesticides entirely. Organic fertilizers will suppress pesticide residues and maintain or increase rice nutrition.

Food is a basic and basic need, directly and indirectly related to the condition of health, intelligence, security, productivity of human resources and nationally a determinant in the formation of a complete human being. The increase of population in Indonesia also effect it's food needs. One of the crucial global issue is food security, that occurred globally in all parts of the world, included in Indonesia as a developing country. To deal with this problem, the green revolution emerged [2]. As much as 75% of the community's daily calorie intake is determined by rice. Energy needs (63%), protein (37.7%) and iron 25-30% of the total human body needs 75% of calories in Asia from rice and 50% of the world's population depends on rice [3].

The rice production process prioritizes safety and health for long term life. Currently, the largest percentage of farming methods depend on chemical fertilizers and pesticides. Organic and conventional rice cultivation produces organic and non-organic rice. Organic rice is grown using organic agricultural cultivation, which is a natural agricultural technique, based on soil fertility for successful production that takes into account the natural capabilities of the soil, resulting in good quality for agriculture and the

---

<sup>3</sup>University of Muhammadiyah Metro, <sup>2</sup>DKP3 Metro [sutanto11@gmail.com](mailto:sutanto11@gmail.com)



environment [4]. Conventional rice cultivation produces non-organic rice, this cultivation uses chemicals, both fertilizers and pesticides. In addition to this situation, rice becomes unhealthy because chemical residues will be in the rice, so the soil, water and the existing ecosystem will be disturbed. Beside that, continuous use of different chemical agents such as insecticides, weedicides and fungicides, will affect underground water and causes emission of greenhouse gases from agricultural soils and it could deteriorated the natural ecosystem [5].

The results of the isolation of pineapple liquid waste bacteria found 15 isolates capable of degrading agricultural organic waste into organic fertilizer called Pumakkal [6]. Organic fertilizer was applied to rice plants for three harvests, compared to conventional cultivation to produce rice data with chemical residues in Table 1 below.

**Table 1. Pesticide residues in rice with organic cultivation of Pumakkal and conventional fertilizers in Tejosari Metro in 2021.**

No.	Pesticide residue	Pumakkal Application Organic Rice	Non-organic rice (mg/kg)	Maximum residue limit(mg/kg)*
1.	azinphos methyl	negative	0.006616583	0.2
2.	bendiocarb	negative	0.004595888	0.02
3.	benomyl	negative	0.008304414	5
4.	carbaryl	negative	0.02323584	5
5.	carbofuran	negative	0.03985826	0.2
6.	chart	negative	negative	0.1
7.	chlordane	negative	negative	0.02
8.	chlorfenapyr	negative	0.002522238	0.05
9.	chlorfenvinphos	negative	0.000526848	0.05
10.	chlorpyrifos	negative	0.002854192	0.5
11.	chlorpyrifos methyl	negative	0.006100088	0.1
12.	diazinon	negative	0.0232701	0.1
13.	difenoconazole	negative	0.002052531	0.1
14.	diquat	negative	negative	0.10
15.	disulphoton	negative	negative	0.5
16.	edifenphos	negative	0.0118189	1
17.	endosulfan	negative	negative	0.1
18.	endrin	negative	negative	0.02
19.	phenitrothion	negative	0.007912116	1
20.	fenthion	negative	0.005418731	0.05
21.	fipronil	negative	negative	0.01
22.	glyphosate	negative	0.003074515	0.1
23.	iprodione	negative	negative	10
24.	phenothrin	negative	0.007427179	0.1
25.	phenthoate	negative	negative	0.05

\*SNI 7313:2008 concerning the maximum limit of pesticide residues in agricultural products.

Table 1. Shows differences in pesticide residue levels in organic and non-organic rice. All organic rice had negative levels of 25 pesticide residues, while non-organic rice had 9 negative residues and 16 had residues. 64% of non-organic rice contains pesticide residues with levels below the threshold of the Indonesian National Standard SNI SNI 7313:2008 concerning the maximum limit of pesticide residues in agricultural products. There was a significant difference from the application of organic fertilizer for 3 harvests, 25 kinds of pesticide residues were negative. In contrast to 64% non-organic rice there is a pesticide residue. Although the residual value of non-organic rice pesticides is below the threshold, this residue level becomes a problem if consumed continuously and in the long term it will accumulate in humans. The accumulation of pesticide residues (biomagnification) in humans adversely affects the emergence of various mild to severe diseases.

The application of Pumakkal organic fertilizer in rice cultivation provides an opportunity to reduce the use of chemicals and increase soil fertility. The use of Pumakkal organic fertilizer in rice cultivation produces organic rice compared to conventional/non-organic rice cultivation, the nutritional content is in Table 2. below.

Table 2. Nutritional Content of Organic Rice for Pumakkal application and non-organic rice in Tejosari Metro City in 2021.

No.	Parameters - Unit	Pumakkal app organic rice	Non-organic rice
1.	Proteins (%)	8	6.8
2.	Fat (%)	0.8	0.6
3.	Water (%)	12	12.2
4.	Ash (%)	1.8	1.5
5.	Crude fiber (%)	1.5	1.2
6.	Carbohydrates (%)	77.3	78.6
7.	Niacin (mg/100 g)	1.9	1.5
8.	Pyridoxine (mg/100 g)	0.16	0.12
9.	Pantothenic acid (mg/100 g)	1.09	0.8
10.	Thiamine (mg/100 g)	0.10	0.07
11.	Riboflavin (mg/100 g)	0.07	0.05
12.	Glucose (%)	0.2	0.3

No.	Parameters - Unit	Pumakkal app organic rice	Non-organic rice
13.	Glycemic index (%)	69	72.4
14.	Vitamin A (SI/100 g)	0	0
15.	Vitamin C (mg/100 g)	0	0
16.	Vitamin D2 (mg/100 g)	0	0
17.	Vitamin D3 (mg/100 g)	0	0
18.	Total Fe (mg/100 g)	1.3	0.8
19.	Total P (mg/100 g)	220.3	173
20.	Total Se (mg/1000 g)	0.08	0.07
21.	Total Mn (mg/100 g)	1.11	1
22.	Total Mg (mg/100 g)	26.6	24
23.	Total Amylose (%)	20.5	22.6
23.	Total Amylopectin (%)	30.7	33.7
24.	Shape degree (%)	100	100
25.	Water (%)	12.08	12.3
26.	Head item (%)	97.8	97.6
27.	Head item (%)	1.8	2.06
28.	Groats (%)	0	0
29.	Red item (%)	0	0
30.	Yellow/broken grain (%)	0	0
31.	Calcifying grains (%)	0	0
32.	Foreign object (%)	0	0
33.	Grain (%)	0	0

Table 2. Shows that the Pumakkal application produces organic rice with higher nutritional content than non-organic rice. The content of protein, fat and other nutrients is higher, while carbohydrates, glucose and the glycemic index are lower. The sugar content as reflected in carbohydrates, glucose and lower glycemic index than non-organic rice, allows organic rice to be healthier, especially for consumers who have problems with sugar and also diets high in fiber. There are many varieties of rice grain in the world, which vary considerably produce the repon of postprandial blood glucose (PPG) [7]. It means that, rice is one of the causes of diabetes because of its glucose content. So, the lower index of glucose, the healthier the rice.

The description above shows that the use of Pumakkal fertilizer in rice farming produces healthy organic rice as seen from the negative pesticide residues and the high nutritional value of rice compared to conventional cultivation of non-organic rice. The benefits of organic farming for biotic abundance, biotic richness and profitability are high against variation in each of the covariates evaluated by [8], while mean yields are lower for organic systems across these comparisons.

The interaction of tillage management and soil microbial functioning shown more beneficial for balanced and sustainable agriculture [9]. Using organic fertilizer and reduce pesticide cultivation is one of the effort to make environmentally friendly arboricultural soil management practices. So that it can enhance soil nutrient's cycling, reduce the burden on the environment, and promote food safety and security [10]. Organic cultivation need more time in cultivation proses compared with conventional cultivation, so the farmers spend a lot of time by taking organic cultivation [11].

Forming a knowledge network or even cooperatives is becoming one of the factor to make Organic Agriculture success. Not only for increase profit, but also The formation of a knowledge network, or even the formation of cooperatives, has great potential in OA, not only for increased profits but also be the connector of producer, innovator, pioneers of change, and better decision [12]. From the research of [13] found that enthusiasts of organic farming systems come from experienced and older people. only a small percentage of young people participate in organic farming. whereas the involvement of youth in agriculture is a major barrier to long-term growth in the organic rice industry in Thailand. Strategic issue that should be considered in the success of farming development like organic farm are technology about quantity and quality of product, equipment provison, raw material and manpower's skill. Also government support, work change, profitability, investment, risk, market, sustainability, and friendly environment [14]. Organic farming is a shared responsibility for a better and more sustainable life.

## **Conclusion**

Rice cultivation using Pumakkal organic fertilizer produced organic rice with negative residue levels, while 64% non-organic rice contained pesticide residues below the SNI threshold. Rice cultivation using Pumakkal organic fertilizer produces organic rice with higher nutritional value than non-organic rice.

## References

- [1] M. A. M and G. M. A, "Pesticides Usage, Awareness, Practices and Health Effects among Farmers in Jere Bowl, Borno State, Nigeria," *J. Agric. Crop. ISSN*, vol. 3, no. 3, pp. 25–28, 2017, [Online]. Available: [https://www.arpgweb.com/pdf-files/jac3\(3\)25-28.pdf](https://www.arpgweb.com/pdf-files/jac3(3)25-28.pdf).
- [2] L. Y. Devi, Irham, Subejo, E. Anatasari, A. Nurhayati, and A. Wahyu Widada, "Key drivers of organic rice productivity in Sleman and Magelang Regencies," *IOP Conf. Ser. Earth Environ. Sci.*, vol. 746, no. 1, 2021, doi: 10.1088/1755-1315/746/1/012005.
- [3] Haryadi, *Teknologi Pengolahan Beras*. Yogyakarta: Gadjah Mada University Press, 2006.
- [4] K. Murniati, "Pola Pengambilan Keputusan Rumah Tangga Petani Dalam Menerapkan Teknik Pertanian Organik dan Anorganik di Kecamatan Pagelaran Kabupaten Tanggamus," 2006.
- [5] S. Fahad *et al.*, "Bio-based integrated pest management in rice: An agro-ecosystems friendly approach for agricultural sustainability," *J. Saudi Soc. Agric. Sci.*, vol. 20, no. 2, pp. 94–102, 2021, doi: 10.1016/j.jssas.2020.12.004.
- [6] A. Sutanto *et al.*, "The effectiveness of pumakkal organic waste bioremediator," *Int. J. Adv. Sci. Technol.*, vol. 29, no. 7 Special Issue, pp. 132–143, 2020.
- [7] H. M. Boers, J. Seijen Ten Hoorn, and D. J. Mela, "A systematic review of the influence of rice characteristics and processing methods on postprandial glycaemic and insulinaemic responses," *Br. J. Nutr.*, vol. 114, no. 7, pp. 1035–1045, 2015, doi: 10.1017/S0007114515001841.
- [8] O. M. Smith *et al.*, "Organic Farming Provides Reliable Environmental Benefits but Increases Variability in Crop Yields: A Global Meta-Analysis," *Front. Sustain. Food Syst.*, vol. 3, no. September, pp. 1–10, 2019, doi: 10.3389/fsufs.2019.00082.
- [9] J. Liu, Y. Song, M. Tang, Q. Lu, and G. Zhong, "Enhanced dissipation of xenobiotic agrochemicals harnessing soil microbiome in the tillage-reduced rice-dominated agroecosystem," *J. Hazard. Mater.*, vol. 398, p. 122954, 2020, doi: <https://doi.org/10.1016/j.jhazmat.2020.122954>.
- [10] T. Kai and D. Adhikari, "Effect of organic and chemical fertilizer application on apple nutrient content and orchard soil condition," *Agric.*, vol. 11, no. 4, pp. 1–10, 2021, doi: 10.3390/agriculture11040340.
- [11] W. David, Ardiansyah, N. Asiah, and S. Madonna, "Comparative study on agrochemical residue on rice cultivation in Tasikmalaya, Indonesia: Organic versus conventional," *Futur.*

- Food J. Food, Agric. Soc.*, vol. 8, no. 2, pp. 1–12, 2020, doi: 10.17170/kobra-202007201468.
- [12] C. F. Cidón, P. S. Figueiró, and D. Schreiber, “Benefits of organic agriculture under the perspective of the bioeconomy: A systematic review,” *Sustain.*, vol. 13, no. 12, 2021, doi: 10.3390/su13126852.
- [13] N. Seerasarn, S. A. Miller, and A. Wanaset, “Transitioning to organic rice farming in thailand: Drivers and factors,” *Asian J. Agric. Rural Dev.*, vol. 10, no. 3, pp. 740–748, 2020, doi: 10.18488/journal.ajard.2020.103.740.748.
- [14] M. A. Ramdhani and E. Santosa, “Key Succes Factors for Organic Farming Development,” *Int. J. Basic Appl. Sci.*, vol. 1, no. 1, pp. 7–13, 2012, doi: 10.17142/ijbas-2012.1.1.2.

# **Social Capital in the Empowerment of Muslim Communities Face 5.0 Society**

Agus Wahyu Triatmo<sup>4</sup>

## **Introduction**

The era of globalization ushered in every country or community becoming a member of a global village. No matter a country or community has the same level or not as another country or community, but surely all global villagers are faced with the same challenges. The ability to respond to these challenges becomes a condition for them to continue to exist. There's no reason to hide in the face of that challenge.

The challenge that is happening right now is the presence of the industrial revolution 4.0. Revolution 4.0 is characterized by the development of information technology as one of the aids used by humans doing work, which among others; Internet of Things (IoT), big data, 3D printing, Artificial Intelligence (AI), driverless vehicles, genetic engineering, robots and smart machines[1].

As laypeople, the presence of revolution 4.0 has had an impact on our lives. In the economic field, the development of revolution 4.0 has given rise to e-commerce (electronic commercial) which is increasingly in demand by the public[2][3]. In the social field, the development of digital technology has also led to an explosion in the number of unemployed, especially in developing countries, where the presence of digital technology is not balanced by an increase in the quality of human resources.

The various things mentioned above must certainly be addressed and responded appropriately by any community so that they can get the blessing of the presence of revolution 4.0. The Japanese government, for example, is aware of the impact of the development of digital technology brought by revolution 4.0. In response, the Prime Minister of Japan launched a more humanist roadmap, known as the super-intelligent society (5.0 society). Namely, the order of society that is human-centered and technology-based[4].

The World's Muslim community currently makes up 24% of the world's population.[5]. Most Muslim communities occupy Asia and Africa, a small portion on the other three continents.[6]. Indonesia is

---

<sup>4</sup> University Raden Mas Said Surakarta

the country with the largest Muslim population in the world. No less than 231 million Muslims are Indonesian citizens. [7].

All Muslim communities are part of the world's population that must answer the challenges that exist so that they still exist in this global village. Failure to respond to these challenges will be the cause of the Muslim community as a bankrupt community.

As a religiously based community, whatever the Muslim community does is always related to Islam as a religion as well as a guide to life. Islam is the social capital of Muslims. When Islam is understood as an anti-change religion, it will certainly have implications for Muslim social behavior which is also anti-change. Conversely, if Islam is understood as a value and life guideline that supports change, it will also have implications for Muslim behavior that responds and proactively to social change.

Against that background, this short article will try to describe Islamic values as social capital, which may potentially be a reference for Muslims in response to the presence of industrial revolution 4.0 and 5.0 society.

## **Discussion**

### **Activation of Islam as Social Capital**

Social capital becomes an important concept in community empowerment because, in community empowerment, development is carried out from the bottom up. Society, complete with values, attitudes, and beliefs that affect trust, solidarity, a reciprocity that encourages the creation of cooperation in society – which is then referred to as social capital – plays an important role and determines the development process. This is where social capital becomes one form of development capital in addition to financial capital and physical capital. As stated by Bisena in Mardikanto [8], Social capital, as well as financial capital and physical capital, can also be converted into strategic resources and have economic value in realizing development goals.

The concept of social capital arises from the thought that members of society are unlikely to be able to individually address the various problems at hand. There is a need for good togetherness and cooperation from all members of the community who are interested in overcoming this.[9]. This is where the importance of social capital can be a foundation of cooperation among community members to achieve development goals.

According to Putnam, social capital is the parts of social organizations such as beliefs, norms, and networks that can improve people's efficiency by facilitating coordinated actions. [10]. Fukuyama



in Norton[11], Social capital is a set of informal values or norms shared among the members of a group that enables cooperation.

As Fukuyama stated in Mardikanto [8], Social capital is the capability that arises from a common belief in society or certain parts of it. Social capital is transmitted through cultural mechanisms such as religion, tradition, and historical customs. Social capital is the backbone of human development and economic development in every country.

Based on the explanation of the above experts, it can be understood that for the Muslim community, Islam is social capital. Islam as a religion becomes a reference for its people to determine good, right wrong, noble, and despicable an action. Therefore, every Muslim anywhere and at any time has the same standards and finally has a mutual agreement to do noble things and instead abandon the things that are considered despicable. It is at this point that Islam becomes the norm system that becomes the basis for the emergence of positive actions for all members of the Muslim community.

As a social capital, Islam can improve the efficiency of society by facilitating coordinated actions. Islam is also a system of values embraced by all members of the Muslim community that allows cooperation both in small scopes and in large spheres such as the state and even between countries.

Based on these values, Muslims everywhere can be motivated and encouraged to perform broader social roles. Further, Islam for regional and international Muslim communities can be used as a foundation for cooperation in the fields of economics, politics, and the development of knowledge and technology.

But has Islam become a social capital for development among the Muslim community? The answer is that many variables affect the effectiveness of Islam as social capital. Among them is whether the Muslim community has made Islam an active system of values, becoming the cornerstone of the lives of individual members of the Muslim community. When they have not activated Islam as a system of values, then of course Islam has not functioned as social capital. For secular Muslims, for example, Islam has not been activated as a system of values that underlie their lives. Islam has not yet become social capital for secular Muslims.

As Coleman said [12], social capital can be created, maintained, and undermined by the consequences of the individuals' decisions. Some of the factors that destroy social capital include closure, stability, ideology, class, and wealth. In the case of ideology, for example, a Muslim community but forced to adhere to another ideology, especially if the ideology is contrary to Islam, then

automatically Islam as social capital cannot be activated by the Muslim community.

Therefore, social capital is not merely seen as a result but rather a process. Social capital undergoes continuous formation and always accumulates itself. Unlike other forms of modalities, social capital will never run out when used. The quality of social capital will be better if often used. The quality of social capital will be better if often used. In this regard, some common factors that influence capital formation are habits, position (role of actors), education, socioeconomic classes, and personal values.[13].

In the context of the Muslim community, Islam is not an automatic social capital that actively serves to encourage community members but rather needs to be activated through a process of understanding the teachings of a religion that values common sense (not doctrinaire), enlightening education, and culture, so that Islam can be freely implemented in real life in the Muslim community.

#### *The Industrial Revolution 4.0: A Challenge*

The term Industrial Revolution 4.0 was first coined by Professor Klaus Schwab. A famous German economist wrote in his book: *The Fourth Industrial Revolution*. Professor Klaus Schwab is convinced that we are at the beginning of a revolution that fundamentally changes the way we live, work and relate to each other, which he explores in his new book, *The Fourth Industrial Revolution*. [14]

Please note that there have been four industrial revolutions in our lives. Revolution 1.0 is marked by the discovery of steam engines that cause mass production. The second revolution was marked by the occurrence of electrification. Revolution 3.0 is characterized by the use of computerization. Industrial revolution 4.0 is characterized by the digitization of data and information.[15]. If the previous revolution freed humanity from animal power, it enabled mass production and brought digital capabilities to billions of people. However, Revolution 4.0 is fundamentally different. It is characterized by a variety of new technologies that blend the physical, digital, and biological worlds, impact all disciplines, economics, and industry, and even challenge ideas about what it means to be human.[16].

Revolution 4.0 is not just an extension of revolution 3.0. Revolution 4.0 was marked by the spectacular development of digital technology. These developments include the internet of things (IoT), big data, 3D printing, artificial intelligence (AI), and robotic technology. The synergy between these findings led to rapid and not linear development. That is why revolution 4.0 has caused a graying

or uncertainty, especially in the industrial world, and other areas of life.

Revolution 4.0 has forced changes to the old order to be replaced with a new order. In the socio-economic field, for example, revolution 4.0 led to the loss of many old professions and instead has given birth to many new types of professions. In revolution 4.0, man is not fully able to control or as a subject of the changes that occur. Many people feel that humans occupy a position as objects of change.

Human phenomena as objects are widely experienced by citizens who come from developing countries. With various problems wrapped around it, causing citizens of developing countries are less able to use the development of digital technology as a tool to improve their welfare.

### **5.0 Society: An Opportunity**

Anticipating the human tendency as an object in revolution 4.0, the Government of Japan through its Prime Minister delivered a road map for the development of a new social system that is more humanistic called society 5.0 (super-smart society). 5.0 society is the further development of the hunting community at 1.0, the agricultural community at 2.0 society, the industrial community at 3.0 society, and the digital information society at 4.0 society.

Revolution 4.0 is a super-smart society. With IoT, everything is inanimate and alive, as well as humans are connected through sensors and wireless connectivity. All data about the state of real time is collected in Big Data. Robots with AI intelligently analyze data while making decisions. Each of these consumes and produces data at the same time.[17].

"Society 5.0" aims to create a cyber-physical society where (among other things) the daily lives of citizens will be enhanced through increasingly close collaboration with artificial systems.[18]. In society 5.0, people are not the only members of society. Humans will live alongside increasingly autonomous social robots with AI. With these 5.0 societies, where there is integration between cyber and physical, it is expected that there is a balance between economic welfare and social harmony. Humans will be easier to live life, not the occurrence of gender discrimination, the loss of social inequality of cities and villages.

To achieve a community that is defined as a super-smart society, it takes various future services in various sectors. This can be met with strong technological capabilities, as well as the presence of competent human resources in their respective fields to carry out

their profession digitally while contributing to providing better services for the community. [16].

It takes human resource competencies to be able to realize humans as subjects in 5.0 society. Some of these competencies are critical thinking, communication, cooperation, and collaboration. This picture is also a kind of demand for anyone who wants to continue to exist in society 5.0. The question is how can the Muslim community qualify with Islam as its social capital?

### **Muslim Community Development: Islam as Social Capital faces 5.0 Society**

In this section, it will be explained the extent to which Islamic values as social capital can be the basis for the birth of the constructive attitude of Muslims to survive in the era of 5.0 society.

#### *Science*

The most important part that makes Islam a resilient social capital for Muslims to enter the industrial revolution 4.0 as well as the order of society 5.0, even the modern era in general, is Islam's commitment to science.[19]. This commitment to science has been proven to make Islam a social capital for classical Muslim societies, which with the role of Muslim scholars in the development of science in the middle ages, succeeded in lifting the dignity of Islamic civilization to lead world civilization. Islam in the middle ages was not only a doctrine, but the spirit of science, with which Islamic civilization even became an advanced civilization.

Likewise Islam in the era of 5.0 society today. It is true that in the era of 5.0 society, religion was not something that mattered.[20], But the religion that gives the spirit of its adherents to think rationally, objectively, pragmatically, efficiently, supporting the development of science and technology, is still needed by humans. *Tawhid* — is the most basic value in Islam — is not only a formal theological formula, but a value that will give birth to other values that are always needed by humans, such as truth, justice, usability, and beauty.[21]. According to the author, an unnecessary religion is one with rigid doctrinal formalism. Meanwhile, the religion that will always be important in human life is a religion whose values do not conflict, even supporting the progress of the times.

#### **Work ethic,**

Another value that strongly supports Islam as social capital is work ethic. Because of the strong work ethic in Islam, some teachings that are often suspected to be the basis of passivities such as *tawakal* and *zuhud* or asceticism, are not left to stand alone but are combined

with the obligation of effort and doing. This work ethic is rooted in Islam's view of the world. Unlike other religions, Islam views the world positively. That's why the view of Sufism who extremely rejects the world will always be resisted by mainstream scholars, and finally only in peripheral positions.

But why are Muslims in general in this world still a defeated people? The answers that Muslims still fail to present the noble Islam in their personal and social personalities, because Islam has not been activated by Muslims. Some things should be suspected to be the cause. The first is because some Muslim communities are not rulers or governments that can control their country and nation. Even some Muslim communities, the majority in a country, are currently in a powerless state. Muslim communities are still more objects controlled by those who politically, economically, socially carry secular aspirations. This is where the boundaries of Islam appear to not be activated by the Muslim community.

The second reason is the factor of the quality of human resources in the Muslim community that is still low compared to other nations. In general, it can be stated that many Muslims live in countries that are classified as still lagging, and some others live in some developing countries. In some developed countries, Muslims are a minority. The low quality of human resources will certainly limit their model and religious quality. Muhammad Abduh in Nurcholis Majid[19], stated that *al-Islam mahjub un bil-mukminin* (Islam is closed by Muslims themselves). Even, for now, Islam is identic with negative stigmas such as terrorists, violence, coercion of will, criminality, underdevelopment, seedy, and so on. It could all be due to the low cauldron of Muslim human resources.

Islam as a doctrine has been perfect, as evidenced by the many positive recognitions of Islam from the intellectual circles of Western countries. Among them is Ernest Gellner.[22], Garaudi[23], and other Western scientists, who with their critical thought and intellectualism, eventually discovered Islam.

## **Conclusion**

Islam is one of three pseudo-religions that will serve as social capital in empowering Muslim communities facing the 5.0 era of society. It is based on two reasons; First, Islamic principles are in line with the development of science. Second, the Islamic view of work ethic. This is not automatically actualized in Muslim civilization. Islamic activation steps are needed in the Muslim personality personally and socially.

## References

- [1] Y. Puspita, Y. Fitriani, S. Astuti, and S. Novianti, "Selamat tinggal revolusi industri 4.0, selamat datang revolusi industri 5.0," 2020.
- [2] K. K. dan I. R. Indonesia, "Kemkominfo: Pertumbuhan e-Commerce Indonesia Capai 78 Persen," *Sorotan Media*, 2019. <https://kominfo.go.id/content/detail/16770/kemkominfo-pertumbuhan-e-commerce-indonesiacapai-78-persen>.
- [3] H. A. Mumtaha and H. A. Khoiri, "Analisis Dampak Perkembangan Revolusi Industri 4.0 dan Society 5.0 Pada Perilaku Masyarakat Ekonomi (E-Commerce)," *PILAR Teknol.*, vol. 4, no. 2, 2019.
- [4] M. E. Gladden, "Who will be the members of Society 5.0? Towards an anthropology of technologically most humanized future societies," *Soc. Sci.*, vol. 8, no. 5, 2019, doi: 10.3390/socsci8050148.
- [5] N. Aisyah, "Ini Agama Terbesar di Dunia 2021, Pemeluk Terbanyak Sampai Milyaran," *detik.Edu*, 2021.
- [6] World Population Review, "Muslim Population by Country 2021," 2021. [Online]. Available: <https://worldpopulationreview.com/country-rankings/muslim-population-by-country>.
- [7] B. A. Wiguna, "10 Negara dengan Penduduk Muslim Terbanyak di Dunia," *Tempo.co*, Jakarta, 2021.
- [8] T. Mardikanto, T. Aprillia, and K. S. Andini, *Pengembangan masyarakat community development, Acua bagi akademisi dan pemerhati pengembangan masyarakat*. Surakarta: UPT.UNS Press, 2014.
- [9] R. Syahra, "Modal sosial: Konsep dan aplikasi," *J. Masy. dan Budaya*, vol. 5, no. 1, pp. 1–22, 2003.
- [10] R. D. P. Putnam, "The Prosperous Community Social Capital and Public Life," *Am. Prospect*, 1993, [Online]. Available: <http://faculty.washington.edu/matsueda/courses/590/Readings/Putham 1993 Am Prospect.pdf>.
- [11] A. Norton, "Filling the 20 Percent Gap: Francis Fukuyama on Trust and Social Capital," *Agenda*, vol. 3, no. 3, pp. 351–358, 1996, [Online]. Available: [http://press-files.anu.edu.au/downloads/press/p82851/pdf/review\\_article01.pdf](http://press-files.anu.edu.au/downloads/press/p82851/pdf/review_article01.pdf).
- [12] J. Coleman, *Fondation of socials theory*. Cambridge Mass: Harvard University Press, 1990.
- [13] R. Fathy, "Modal sosial: Konsep, inklusivitas dan pemberdayaan masyarakat," *J. Pemikir. Sociol. Vol. 6 No. 1, Januari 2019*, vol. 6, no. 1, 2019, [Online]. Available: <https://jurnal.ugm.ac.id/jps/article/view/47463>.

- [14] W. E. Forum, "The Fourth Industrial Revolution, by Klaus Schwab," *World Economic Forum*, 2021. <https://www.weforum.org/about/the-fourth-industrial-revolution-by-klaus-schwab> (accessed Nov. 29, 2021).
- [15] A. Budiman, "Kolom pakar: Industri 4.0 vs Society 5.0," *Humas FT UGM*, Yogyakarta, 2019.
- [16] I. Sabria, "Peran Pendidikan Seni Di Era Society 5.0 untuk Revolusi Industri 4.0," 2019.
- [17] V. Özdemir and N. Hekim, "Birth of Industry 5.0: Making Sense of Big Data with Artificial Intelligence, 'the Internet of Things' and Next-Generation Technology Policy," *Omi. A.J. Integr. Biol.*, vol. 22, no. 1, pp. 65–76, 2018, DOI: 10.1089/omi.2017.0194.
- [18] M. E. Gladden, "Who Will Be the Members of Society 5.0? Towards an Anthropology of Technologically Posthumanized Future Societies," *Soc. Sci.* 2019, 8(5), 148; vol. 8, no. 5, 2019, DOI: <https://doi.org/10.3390/socsci8050148>.
- [19] N. Madjid, *Islam doktrin dan peradaban*. Jakarta: Paramadina, 2008.
- [20] L. Epafra, "Masyarakat 5.0," 2019, doi: 10.13140/RG.2.2.15941.50407.
- [21] F. Rahman, *Major Themes Of the Qur'an*, Chicago: Minneapolis. Bibliotheca Islamica., 1980.
- [22] E. Gellner, *Muslim society*. Cambridge: Cambridge University Press, 1981.
- [23] N. Nasrullah, "Buku Karya Mualaf yang Membuat Zionis 'Kebakaran Jenggot,'" *REPUBLIKA.co.id*, Jakarta, 2020.

# Transformation Of Religiosity Of The Community At Wonolagi Gunung Kidul Yogyakarta

Ahmad Salim<sup>5</sup> Novi Handayani<sup>6</sup>

## Introduction

Change or transformation is a necessity that cannot be avoided in aspects of human life. All aspects of human life must undergo changes, either caused by internal or external factors in human life.[1] Internal factors consisting of perceptions, values, public beliefs can affect changes in human life. External factors such as modernity which is marked by the development of science and technology will clearly affect demographic changes, the level of formal education of the community, and can also affect religious activities that occur in society.[2] People's religious activities that are based on values can experience changes both in terms of how they are carried out, time, and place.

This change in religious activity is mainly influenced by social changes as a result of relations and dialectics in society. Globalization which is marked by the rapid development of science and technology has a major role in changing the religious activities of the community, because through this technological assistance, community relations occur globally and massively.[3] This relationship has many implications for changes in perceptions and values held by the community in responding to the forms of religious rituals that exist around them. In a global context, changes in religious activity do not only occur in urban communities but also occur in rural communities.[4] The difference between urban and rural communities is very thin and even difficult to separate and distinguish. The form of transformation that occurs in urban areas is also found in rural areas, and vice versa. For example, *genduri* activity can be found in these two communities, although with different innovations.

The Wonolagi community is a group of people who inhabit at Wonolagi Ngleri Hamlet, Playen Gunung Kidul D.I Yogyakarta. As a mountain community, residents still maintain the traditions that are the hallmark of the community. There are many traditions related to the values and beliefs of the community which are manifested in

---

<sup>5</sup> Alma Ata University

<sup>6</sup> Alma Ata University



various religious activities. Some of the religious activities carried out by the 215 people are; the apostleship ceremony, offerings, alms, *metik*, *merti dusun*. The character of rural communities with farmers (54.7% of the total population) as the main source of livelihood is the dominant factor in maintaining several traditions that have internalized in this community.

Along with the ongoing social changes, some of these religious rites underwent changes, both in the procedures for their implementation and the time so that it had implications for the reduction of the sacredness of existing rituals. Many activities in the name of religion in society lose the meaning, activities are just routines that are more oriented to social and economic aspects apart from the meaning of religion which is sacred. So this research is important to do, because researchers will reveal the relation of community rationality to the transformation of religious rites in society as well as several supporting factors in the transformation of religious practice.

## **Discussion**

### **Religious Rituals of the Wonolagi Community of Gunung Kidul Yogyakarta**

Rural communities have several characteristics, one of which is being subordinate to nature.[5] This reality is very realistic when viewed from the livelihoods of many people related to nature, namely farmers. This condition has implications for the number of community activities that rely on nature around their environment. Several religious ritual activities have a lot to do with efforts to protect the community from the nature that surrounds them. Ritual activities are a form of dialectic between humans and nature to achieve a balance in society, so that nature does not pose a threat to human existence, and vice versa, nature is not damaged because of the existence of humans around it.

As a Javanese society, which is famous for its steadfastness in holding on to existing traditions,[6] So the Wonolagi people try to maintain the traditions that have been rooted in the community. The preservation of this tradition is not only intended to maintain the relationship between the community and the natural surroundings, but also to maintain harmony between residents. Although there is contradiction of interest in social, religious and cultural contexts due to the development of the community concerned in multi-dimensional life, but in real terms, religious rituals in such a society are still ongoing.[7] Because religious rites are one of the instruments that can bring together citizens in society.[8] Through various religious

activities that involve almost all residents, they can relate to one another so that harmony between them can be maintained. The majority of the people of Wonolagi are Muslims, but the tradition of religious rituals is still carried out by the community

Based on the results of interviews with several respondents, the religious ritual of the Wonolagi community is a social activity that has been carried out by the community for a long time, no one knows since when this religious activity began. The community continues to carry out the ritual with the aim of being grateful for all the gifts that have been received from the God, and asking for safety in their lives. Some of the religious rites that exist in the Wonolagi community, namely:

*Rasulan*, is a religious rite of thanksgiving to God for the abundant harvest of crops grown mainly rice plants. This event was held in Islamic calendar called by *rabiul akhir*, *jumadil ula*, and *muharram* months. The series of events carried out were *dzikir* and *tahlil* together and ended with prayer. The series of activities are led by a priest (*rois*) who is trusted by the community as a person who has religious and charismatic competence in the community. The event, which was held at the hamlet's house, was equipped with various kinds of food brought by the community independently, namely *weton*/holy rice. Several types of food served are then eaten together by the people who attend the event.

*Metik*, is a religious rite when people will harvest rice. This activity is a form of gratitude for the residents for the abundance of grace given by the authority (God) over the abundant harvest. Besides that, it is also a medium to ask the God to always be given safety for the residents so that they can carry out their farming activities and the next time they will be given more abundant harvests. The activity began with picking the harvest by priest and continued by reading a prayer for the harvest that had been given by God. Residents who own rice fields serve food to other residents in the form of several foods, namely, grilled chicken, snacks, rice, wrapped in teak leaves, chili sauce, complete package called *ubo rampe*. In addition to the food eaten by the participants who attended this event, food was also given to the children in the village. After this picking event is over, residents who have rice fields begin to harvest rice using various tools.

*Sesajen*, is a community rite that aims to establish communication with supernatural beings, so that the safety of citizens can be maintained. This activity is carried out in the homes of each resident at certain moments/or times and also coincides with a feast to commemorate 7 days-1000 days of death of relatives or family. Some of the things that must be prepared in the offerings can be from

the food side in the form of *apem*, bananas, young coconuts, rice as well as chicken, flowers of various types. This food offering is placed in the corner of the house in the afternoon and after the morning is usually taken and thrown away.

*Kenduri cah angon*, is a special religious rite for young people in the community, including in Wonolagi. This activity is organized by the parents of the youth/teenagers and is attended by the youth. Like a feast in general, this activity is also equipped with a prayer led by a rois, the difference is in the involvement of the children in the prayer event and the obligation to take the food served and take it to their respective homes. The various food dishes that are available are the main attraction for teenagers to take part in this event, because according to the child's perception, the food is very delicious and different from the food in each child's home. Through this activity, the children can interact with other children and strengthen the harmonization between the residents, both on the side of their parents and their children. Parents will be able to know in detail the performance of the children around them.

Alms is a religious rite that aims to ask for the safety of their deceased ancestors so that they will be given salvation. This activity is carried out in the month of Shawwal and Great. Residents brought various foods in the form of *tumpang*, holy rice and side dishes to be brought to the hamlet's house. This activity was led by a priest who played an important role in reading prayers on all types of food available and asking for the safety of all residents from all dangers faced by humans. This alms also requires offerings that will be made by each resident's house.

### **The Relation between Rationalization and the Religious Transformation of the Wonolagi Community, Gunung Kidul, Yogyakarta.**

Wonolagi, as a hilly area, this community lives in peace by holding cultural patrons and dependence on the surrounding nature is still quite high as a form of livelihood, such as farming and gardening. However, along with the rapid secularization and modernization that has spread to all lines of society, including hill communities, social change in almost all people's lives is a necessity that cannot be avoided. Historically, secularization supported by advances in science and technology as well as modernity has changed the philosophy of society which ultimately has an impact on certain attitudes and actions played by individuals in society.[9].

Changes in one aspect as a result of secularization and modernization will also affect other aspects, namely the attitude that

prioritizes cognitive and capital. Several dimensions that influence each other are related to the area of human interaction both on a local scale such as between individuals, households and communities, but can also affect on a wider scale such as between cultures, religions, professions and even between nations. In the aspect of religious practice, this cognitive and rational way of thinking has implications for the transformation of the religiosity of society.

Changes in community religiosity occur in several aspects, namely the procedures for carrying out religious rites, time and place or on the equipment used to carry out these activities. Changes in the procedures for carrying out religious rituals can be seen in the apostle's ritual, *metik*, alms and offerings. In the past times the rites of religious activities had to be complemented by reading prayers and mentioning the names and types of food and equipment available. But in the current context, the priority is prayer to ask for the safety of all citizens from all existing dangers, some mention of the name of the item along with the function of the item has been omitted.

In the context of the time and place of implementation, the community's religious rites have also undergone many changes. Religious rites were mostly done during the day in the past, but have been changed a lot in the afternoon and on holidays, for example on Saturday and Sunday nights. The place where religious rituals are carried out, which used to focus on the rice fields, where the hamlet is located, has now changed in several places, for example in the residents' houses. In the context of the equipment used, there have also been many changes. In the past some religious rituals required a complete meal, both on the side of rice and offerings. At present the dishes and utensils are adapted to the conditions of the respective abilities of the residents concerned. But there is a dish that should not be omitted, namely holy rice.

The decrease in the types of equipment used for religious rites today is also a reason for changing or decreasing the types of dishes that must be served, such as *ingkung ayam cemani*. In the current context, this type of *cemani chicken* is very difficult to find, so people don't have to force it to make it. Javanese chicken can be used for this ritual event, considering the difficulty of getting this type of *cemani* chicken. Rationality also affects the fewer people who perform religious rituals of the type of offerings. Only a few Wonolagi residents do it over the age of 60.

The changes that occur are much influenced by the rationalization of society as a result of the relations and dialectics that are played in this modern era. People tend to think cognitively and pragmatically in responding to religious rituals. Changes in people's

livelihoods, which used to be dominated by farmers, have now become more varied, namely freelancers and entrepreneurs who also play a large role in changing religious rites in this community.[10] The average productive age which is dominated by the age range of 26-55 which is at 36.7% also affects the courage of citizens to make changes to the religious rites that have become this tradition. The increasing level of education, which was previously dominated by elementary education graduates, has changed to secondary education graduates, also contributing greatly to changes in community religious rituals.

In Berger's context, some of the social realities of society related to the changing religious rites of society and the fading of religious attitudes above reflect an aridity of meaning for the social and humanitarian activities of the community concerned.[11] The society's dialectic of social reality that is realized through the process of externalization, objectification and internalization is strongly influenced by the reasoning of modernity which tends to be capitalist, so that the domination of the material dimension (profane) is more dominant than the religious dimension which is sacred. The meaninglessness of community activities is based more on the distortion of the meaning of social reality as subjective reality, rarely or not touching objective and symbolic reality.[12] Legitimacy to achieve the meaning of reality as an objective and symbolic reality is reduced by the domination of secularization and modernity. Institutions that have great legitimate authority for the socialization of some noble values are increasingly pressured by the domination of the capitalist system which is the hallmark of secularization.

The modernization process will make religious values a subjective reality without moving to an objective reality, and this happens because of the weak socialization of religious authorities to legitimize religious values into objective reality. Religious values that are still subjective in nature will be difficult to become a symbol that is fully followed by the community without a strong effort from the institution of authority. Religious authorities in the form of religious institutions or educational institutions, as well as community leaders have a major influence on maintaining religious values from the onslaught of modernity which tends to be capitalist and secular. The domination of the rationality of society, which is supported by strong socialization from educational institutions, namely mosques, also supports changes in religious rites that are more practical and are considered in accordance with Islamic teachings. Several series of activities that were deemed not in accordance with Islamic teachings began to be left out, namely, offerings, mentioning the names and functions of food as well as some equipment from religious rites.

## Conclusion

The rationality of society as a consequence of the development of the modernity of a nation has major implications for changes in various aspects of life, including the context of religious rituals that are considered sacred. Rationality does not only occur in urban communities, but also occurs in mountainous communities which are famous for their traditions, including what happened to the Wonolagi people of Gunung Kidul. The development of science and technology has facilitated the rationality of society, so that it has implications for various kinds of religious ritual activities. Changes occur both in the aspects of the procedures for carrying out rituals, place and time or in the meaning of the rituals held. So that religious rituals carried out by the community are not dominantly considered sacred, but are more considered as routine activities and are activities to maintain community harmonization.

## References

- [1] A. Salim, "Relasi Sosial Madrasah terhadap Perubahan Nilai Masyarakat Perbukitan ( Kajian atas Internalisasi Sikap Hormat dan Santun di MI Maarif Kokap Kulon Progo DIY )," vol. IX, no. 2, pp. 113–123, 2018.
- [2] H. Syahrin, *Islam dan Modernitas; Dari Teori Modernisasi Hingga Penegakan Kesalehan Modern*. Jakarta: Prenadamedia Group, 2015.
- [3] A. Giddens, *The Consequences of Modernity*. Stanford: Stanford University Press, 1990.
- [4] N. Q. Ahmad, Suminah, and R. Amanda, "Transformasi Keagamaan Masyarakat Mualaf Dusun Kala Desa Wih Ilang Kecamatan Pegasing Kabupaten Aceh Tengah," *J. As-Salam*, vol. 4, no. 1, pp. 95–109, 2020.
- [5] N. Susilowati, *Sosiologi Pedesaan*. Padang: UNP Press, 2012.
- [6] M. Suseno, *Etika Jawa Sebuah Analisis Falsafi Tentang Kebijakan Hidup Jawa*. Jakarta: PT.Gramedia, 1996.
- [7] S. Sirait, "Religious Attitudes of Theological Tradisional In The Modern Muslim Community Study on Tahlilan in Kotagede Sangkot Sirait tahlilan . According to Muhammadiyah , tahlilan tradition is another form communities . Muhammadiyah teaching standards consider," *J. Indones. Islam*, vol. 10, no. 02, pp. 237–260, 2016.
- [8] Sunhaji, "Between social humanism and social mobilization: The dual role of Madrasah in the landscape of Indonesian Islamic education," *J. Indones. Islam*, vol. 11, no. 1, pp. 125–144, 2017.

- [9] Cook Harvey, *The Secular City*. Princeton, 2013.
- [10] R. Hatu, "Perubahan Sosial Kultural Masyarakat Pedesaan (Suatu Tinjauan Teoritik-Empirik)," *J. Inov.*, vol. 8, no. 4, pp. 1-11, 2011.
- [11] J. M. Dixon and P. L. Berger, "The Sacred Canopy: Elements of a Sociological Theory of Religion," *Sociol. Anal.*, vol. 29, no. 1, p. 40, Mar. 2007.
- [12] L. P. and T. L. Berger, *The Social Construction of Reality A Treatise in the Sociology of Knowledge*. New York: Doubleday, 1966.

# Early Marriage Before and During Pandemic Covid-19 (Revolutionary Era of Society 5.0)

A'im Matun Nadhiroh <sup>7</sup>

## Introduction

Changes in the global economy have influenced changes in the Indonesian economy. The Industrial Revolution is currently in the 5.0 societal age, which is a response to the issues of the preceding industrial era, known as 4.0. Government, transportation, education, health, and business were all impacted by the Industrial Revolution 4.0 [1]. The Industrial Revolution 4.0 and Society 5.0 are nearly identical concepts. The term "society 5.0" refers to a concept developed by the Japanese government. The notion of big data technology acquired by the Internet of Things (IoT) has been transformed by Society 5.0, which uses artificial intelligence (AI) to help enhance people's lives [2][3]. Every facet of life is affected by Society 5.0, including health, urban planning, transportation, agriculture, industry, and education (UU Sisdiknas).

On January 21, 2019, Society 5.0 was released. Society 5.0 is a concept that strives to establish a society where individuals may fully enjoy and feel at ease in their daily lives. The World Health Organization announced a coronavirus disease, also known as the COVID 19 pandemic, at the end of 2019. COVID-19 is a new kind of pneumonia caused by the coronavirus 2 that causes severe acute respiratory illness (SARSCoV2). This virus spreads quickly from person to person and has been found in over 200 nations. The COVID-19 pandemic necessitates a hastening of the society 5.0 revolution, in which nearly all community activities, including employees, teachers, lecturers, students, and students, are encouraged to use digital media to continue teaching and learning activities during the pandemic, as it is impossible to carry out activities outside the home to break the COVID-19 transmission chain. It has been almost two years since the COVID-19 pandemic began, and based on the trend in the appearance of cases, it can be considered that it has begun to drop; yet, there have been several impacts as a result of the COVID-19 pandemic over those two years.

The COVID-19 epidemic has impacted nearly every area, particularly education and health. To stop the virus from spreading, the government has enacted a number of regulations. This has a

---

<sup>7</sup> Universitas Muhammadiyah Surabaya



negative impact on activity levels. The school closure system and distance learning (PJJ) with an emergency curriculum are two of these guidelines. On the ground, policies are unable to be implemented optimally because schools, students, and families are unwilling to adjust to significant changes and establish new habits [4]. Society assumes that enrolling children in school absolves the school of all responsibility for their education, personality development, and behavior modification. As a result, many parents prefer not to plan their children's schooling at home during the summer vacation. Families who play just a minor role in the educational process are perplexed, frustrated, and sometimes angry, accusing the school of abdicating duty. Finally, the parents are forced to clarify a few things, causing their frustration to be relieved by their children. The house is definitely unsuitable for children in this state.

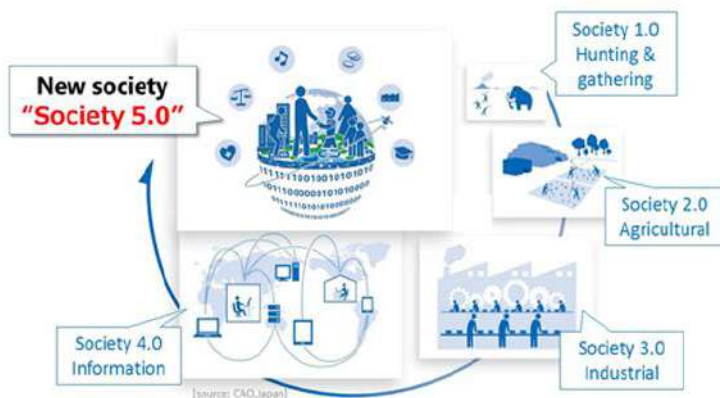
Almost every level of society has seen a drop in income as a result of the COVID-19 pandemic. Some parents believe that their children who study at home are a burden. As a result, parents marry off their children in order to shift the burden to someone else. Learning activities at home give children and/or teenagers the opportunity to mingle in their surroundings, including dating, in addition to the discomfort of studying at home. The family is concerned that if the children date, they may cross the line, so the parents decide to marry right away. During the pandemic, child marriage occurs not just as a result of the parents' wishes, but also as a result of the child's initiative. Even the youngster threatened to shame the family if they were not married because their wooing conduct was similar to that of a married couple. The parents were forced to petition to the religious court for a marriage dispensation after their daughter was born out of wedlock. However, less than two weeks after their marriage, their children were asked to return home due to small disagreements, husbands engaging in domestic violence (KDRT), incompatibility with the husband's family, and so on.

Child marriage (early marriage) has been a long-standing occurrence; now, with the COVID-19 epidemic, the number of child marriages is on the rise. The rate of early marriage among teenagers aged 15-19 years in rural areas is higher than the rate of 3.53 percent in urban areas. Marriages are frequently performed as soon as a girl has her first period, even in some villages. According to a 2015 survey by the University of Indonesia's Center for Gender and Sexuality Studies, Indonesia ranks second in the Southeast Asian region for early marriage. According to UNICEF (2018), Indonesia is ranked 7 [5] in the world for child marriage, although it is rated 2nd in the ASEAN

area, with a child marriage rate of 27.6%, or roughly 23 million youngsters married in Indonesia 2018 [6].

## Discussion

Society 5.0, often known as Society 5.0, is a Japanese social media platform that was launched in the end of January 2019 [7]. Society 5.0 is a human-centered community technology idea that uses technology (AI and IoT) to tackle social problems in both virtual and real-world environments. There were prior versions of Society before 5.0, including Society 1.0 (Hunting Society), Society 2.0 (Farming Society), Society 3.0 (Industrial Society), and Society 4.0. (Information Society). So, in essence, Society 5.0 is a new age in social life that has been combined with technology systems such as the Internet of Things (IoT) and AI (Artificial Intelligence) that can handle and analyze large amounts of data [8][9]. Society 5.0 is intended to address the faults of the 4.0 era; it is believed that in this era, humans will collaborate with technology to develop artificial intelligence that can be used effectively by a large number of people, thereby improving human life.



**Figure 1. Revolution Society 1.0 to 5.0**

In the same year the COVID-19 pandemic occurred when the Indonesian nation began to prepare education to face the 5.0 Community Revolution. It is a disease caused by a large family of new coronaviruses called SARSCoV2 [10]. This virus attacks the respiratory tract and can cause respiratory illness, acute pneumonia, and even death. COVID-19 is a new type of disease that has never been identified in humans. The SARS-CoV2 virus can be transmitted from

person to person through droplet transmission (sneezing, coughing, or large respiratory droplets from a person dropping the droplets), aerosol infection (when someone sneezes or sneezes indoors), or contact. Transmission (touching a contaminated surface then touching the mouth), nose or eyes), direct transmission (kissing, shaking hands, etc.).

The COVID-19 pandemic has had an impact on a variety of sectors, including social, economic, educational, and cultural ones, and it has the ability to alter human behavior at the individual, family, and community levels. The government has implemented a number of programs aimed at breaking the COVID-19 transmission chain, including distant learning (PJJ). Every policy has benefits and drawbacks, and the PJJ strategy's disadvantage is the community's lack of preparedness, particularly among parents and children, in dealing with the pandemic, resulting in new difficulties that have an impact on health, particularly reproductive health (early marriage). Society 5.0 is not an easy thing to achieve overnight; nevertheless, with the COVID-19 epidemic, revolution 5.0 will be achieved more swiftly, even if it begins with all coercion, because it necessitates new adaptations for everyone.

Marriage is one of the most significant events in a person's life. Every living creature has the essential right to marry and continue their offspring. Marriage is a religious, legal, and social ritual in which two individuals celebrate or carry out a marriage vow with the purpose of formalizing the marriage connection according to religious, legal, and social conventions. Early marriage, also known as child marriage, is defined as a marriage that occurs before the child reaches the age of 18, when the child lacks the physical, physiological, and psychological maturity to account for the marriage and the child born as a result of the marriage, and is legal according to religion and state [11][12]. Article 7 paragraph (1) of the Law of the Republic of Indonesia Number 16 of 2019 Concerning Amendments to Law Number 1 of 1974 Concerning Marriage stipulates that marriage is only permissible if both parties have reached the age of 19. (nineteen). Someone getting married at that age has reached adulthood and is capable of carrying out his respective responsibilities and tasks as husband and wife. However, there are many early weddings in reality, notably marriages between men and women who are legally and psychologically immature.

In East Java, the rate of early marriage has reached 39.4 percent. In 2011, the early marriage rate on Madura Island, which is part of East Java Province, was 41.72 percent in Sumenep Regency, 23.25 percent in Bangkalan Regency, 19.39 percent in Pamekasan Regency, and 17.47

percent in rank 4 in Sampang Regency, according to 2011 data. According to the most recent data in 2019, the percentage of early marriages in Bangkalan Regency has decreased by approximately 4.33 percent after eight years, with a total percentage of 19.8 percent. Even if there has been a decrease, the number remains high. According to Yohana Susana Yembise, Minister of Women's Empowerment and Child Protection (PPPA), there are still many early marriage practices in Indonesia's diverse areas, including Bangkalan Regency. Women from low-income homes are more likely to marry at a young age. Furthermore, educational characteristics, prevalent socio-cultural norms, and familial gender disparity [13].

Female child marriage is more common in rural areas than in urban areas, according to the area of residence. This is evident in the first marriage group, which occurs before the age of 18 and before the age of 15. Throughout 2018, the proportion of women aged 20-24 who married before the age of 18 in rural regions remained higher than in urban areas [14]. In rural areas, child marriage accounts for 16.87 percent of all marriages, while in urban areas, it accounts for only 7.15 percent. Over the previous ten years, there has been a fall in prevalence in urban areas that is lower than the decline in rural areas. This could mean that the drop in child marriage is being influenced more by the fall in rural regions. During the 2008-2018 period, the proportion of women 20-24 years old whose first marriage was before the age of 15 declined by 1.8 percentage points in rural areas (2.78 to 0.95 percent), while the decline was just 0.3 percentage points in urban areas (0.59 to 0.28 percent). Similarly, in both rural and urban areas, women 20-24 years old whose first marriage occurred before the age of 18 showed a downward trend from 2008 to 2018. The prevalence in rural regions fell by 5.76 percentage points (22.63 to 16.87 percent), while it fell by less than one percentage point (from 7.82 to 7.15 percent) in urban areas[14].

Early marriage was caused by a number of variables prior to the pandemic, including: 1. education, 2. poverty/economics, and 3. poverty/economics. 3. Criticism of society 4. Beliefs, customs, and culture 5. When the child is still in the womb, the parents come to an agreement on their own. An unwelcome pregnancy, Gender inequality, 6. Family ties, 7. Gender inequality, Poverty and economic survival tactics, number eight. 9. Maintain control over sexuality while preserving family honor 10. Uncertainty, 11. Residence address, Other considerations, child marriage in catastrophe scenarios, tradition and religious issues [14][15]. The prevalence of dropouts and promiscuity exacerbated the rise in early marriages during the pandemic [16]. While the consequences of early marriage are severe for children, they

include issues such as health, education, and labor participation [15]. Pregnancy commonly happens in adolescence as a result of early marriage, and the risk and complications of childbirth rise in the adolescent population. New challenges occur for these ladies, such as not being able to play with their peers their age, being separated from their families because they are married, and this has physical and psychological consequences. Early marriage has an impact on the child's future, which can lead to economic troubles, which can lead to the continuation of the tradition or culture of early marriage because problems will continue to exist [5].

The COVID-19 pandemic has had a significant impact on human life all across the world; in addition to an increase in the number of deaths, gender inequality has emerged. The COVID-19 pandemic has impacted every country on the planet, eroding women's and girls' basic rights, as well as their value and role in society. It's critical to acknowledge that women and girls face a disproportionately higher risk of discrimination, neglect, and abuse and are more likely to experience it [17]. During a pandemic, government initiatives on learning are accompanied by an increase in the number of early marriages or children from various locations, both nationally and internationally. According to Kemenpen/Bappenas, the Covid-19 epidemic is putting 400-500 females aged 10-17 years at risk of marrying young [18]. The reasons for the increased number of child weddings during the epidemic are similar to the reasons for child marriage before the pandemic. The impoverished and uneducated continue to marry their children. Child marriage increases the hazards that children suffer during the pandemic, as well as increasing violence and mental health issues.

The phenomenon of child marriage (early marriage) has been around for a long time; it's just that with the COVID-19 pandemic, followed by the imposition of restrictions on community activities (Lockdown) and the policy of face-to-face school closures, the number of child marriages under the age of 18 is on the rise. During the epidemic, there was a spike in early marriage not just in Indonesia, but also in other regions of the world, including Nigeria [19], Banglades [20], India, South Asia [21], and even Italy [22]. School closures, according to UNICEF, raise the likelihood of marriage by 25% every year, and 2% of girls will never return to school. After the Lockdown, many Nigerian girls do not return to school, and the lack of home income raises the likelihood of marriage by 3% [19]. The causes of high early marriage before and during the pandemic are similar, with poverty and lack of understanding about the consequences of early marriage at the foundation of the problem. Regardless of whether a

pandemic exists, it is critical to always educate teenagers and parents about the necessity of sex education and the consequences of early marriage on both women and men's physical and mental health.

## Conclusion

The COVID-19 epidemic has had a significant impact on everyone's lives. Child marriage (early marriage) was still prevalent in Indonesia and other nations prior to the epidemic. They have surged again as a result of the COVID-19 epidemic, the Revolution Society 5.0, and the policy of school closures and early marriage lockdowns, which had earlier begun to drop. This situation was compounded by a succession of layoffs at the head of the home, resulting in the family's income (economic) declining or even disappearing entirely, so they decided to marry off their children to assist alleviate the family's financial burden. In order to improve knowledge about the detrimental effects of early marriage, health information must still be supplied.

## References

- [1] E. . Natalia.I, "Strategies To Achieve Competitive Advantage In Industrial Revolution 4.0," *Int. J. Res. Cult. Soc.*, vol. 3, no. 6, pp. 10–16, 2019, [Online]. Available: <http://sjifactor.com/passport.php?id=19648>.
- [2] N. Rokhmah and J. Saputra, "Relevant Technology Becomes an Integral Part of the Curriculum," no. 1937, pp. 1–7, 2019, [Online]. Available: [http://repository.unpas.ac.id/42123/1/TEKNOLOGI YANG RELEVAN MENJADI BAGIAN INTEGRAL DARI KURIKULUM.pdf](http://repository.unpas.ac.id/42123/1/TEKNOLOGI_YANG_RELEVAN_MENJADI_BAGIAN_INTEGRAL_DARI_KURIKULUM.pdf).
- [3] V. Özdemir and N. Hekim, "Birth of Industry 5.0: Making Sense of Big Data with Artificial Intelligence, 'the Internet of Things' and Next-Generation Technology Policy," *Omi. AJ. Integr. Biol.*, vol. 22, no. 1, pp. 65–76, 2018, doi: 10.1089/omi.2017.0194.
- [4] E. Andina, "Meningkatnya Angka Perkawinan Anak Saat Pandemi Covid-19," *INFO Singk.*, vol. 13, no. 4, pp. 13–18, 2021, [Online]. Available: [https://berkas.dpr.go.id/puslit/files/info\\_singkat/Info\\_Singkat-XIII-4-II-P3DI-Februari-2021-232.pdf](https://berkas.dpr.go.id/puslit/files/info_singkat/Info_Singkat-XIII-4-II-P3DI-Februari-2021-232.pdf).
- [5] "UNFPA-UNICEF Global Programme to End Child Marriage | United Nations Population Fund." <https://www.unfpa.org/unfpa-unicef-global-programme-end-child-marriage> (accessed Dec. 12, 2021).
- [6] Kemenppa RI, "Profil Kesehatan Anak Indonesia Tahun 2018," *Ilmu Pendidik.*, vol. 5, no. 1, pp. 12–21, 2018.

- [7] M. Iksan Kahar, H. Cikka, N. Afni, and N. E. Wahyuningsih, "PENDIDIKAN ERA REVOLUSI INDUSTRI 4.0 MENUJU ERA SOCIETY 5.0 DI MASA PANDEMI COVID 19," *J. Stud. Ilmu Pengetah. Sos.*, vol. 2, no. 1, pp. 58–78, 2021.
- [8] "Mengenal Society 5.0, Transformasi Kehidupan yang Dikembangkan Jepang | TIMES Indonesia." <https://www.timesindonesia.co.id/read/news/197889/mengenal-society-50-transformasi-kehidupan-yang-dikembangkan-jepang> (accessed Dec. 12, 2021).
- [9] "Society 5.0 - Issuu." [https://issuu.com/perencanaanpelapo5683/docs/warta\\_2020\\_-\\_semester\\_1\\_09\\_september\\_2020\\_final/s/11165137](https://issuu.com/perencanaanpelapo5683/docs/warta_2020_-_semester_1_09_september_2020_final/s/11165137) (accessed Dec. 12, 2021).
- [10] A. E. Gorbalenya *et al.*, "The species Severe acute respiratory syndrome-related coronavirus: classifying 2019-nCoV and naming it SARS-CoV-2," doi: 10.1038/s41564-020-0695-z.
- [11] A. Erulkar, "Adolescence Lost: The Realities of Child Marriage," *J. Adolesc. Heal.*, vol. 52, no. 5, pp. 513–514, May 2013, doi: 10.1016/j.jadohealth.2013.03.004.
- [12] E. Fadlyana and S. Larasaty, "Pernikahan Usia Dini dan Permasalahannya," *Sari Pediater.*, vol. 11, no. 2, pp. 136–41, Nov. 2016, doi: 10.14238/SP11.2.2009.136-41.
- [13] "Hasil Penelitian Hubungan Pernikahan Dini dan Kemiskinan di Bangkalan." <https://news.maduracity.com/2020/12/hasil-penelitian-hubungan-pernikahan.html> (accessed Dec. 12, 2021).
- [14] Badan Pusat Statistik, "Pencegahan Perkawinan Anak Percepatan yang Tidak Bisa Ditunda," *Badan Pus. Stat.*, pp. 6–10, 2020.
- [15] I. D. A. Nurhaeni, "Perkawinan Usia Anak," 2019, [Online]. Available: [https://ppkg.lppm.uns.ac.id/wp-content/uploads/sites/37/2019/12/Pernikahan\\_Anak\\_Ismi\\_short.pdf](https://ppkg.lppm.uns.ac.id/wp-content/uploads/sites/37/2019/12/Pernikahan_Anak_Ismi_short.pdf).
- [16] Y. S. Handayani, M. Faqihurrahman, M. I. Haq, and F. N. Pahlevi, "Impacts and Problems of Early Marriage During the Covid-19 Pandemic," vol. 5, no. 2, pp. 230–237, 2021, doi: 10.24815/sklj.v5i2.21906.
- [17] "COVID-19's impact on women's health and rights | World Economic Forum." <https://www.weforum.org/agenda/2021/09/lessons-must-be-learned-from-covid-19-s-impact-on-women-s-health-and-rights/> (accessed Dec. 12, 2021).
- [18] "KEMENTERIAN PEMBERDAYAAN PEREMPUAN DAN PERLINDUNGAN ANAK."

- <https://www.kemenpppa.go.id/index.php/page/read/25/3056/profil-anak-indonesia-tahun-2020> (accessed Dec. 12, 2021).
- [19] S. S. Musa *et al.*, “Early marriage and teenage pregnancy: The unspoken consequences of COVID-19 pandemic in Nigeria,” *Public Heal. Pract.*, vol. 2, no. May, p. 100152, 2021, doi: 10.1016/j.puhip.2021.100152.
- [20] M. Makino, A. S. Shonchoy, and Z. Wahhaj, “Early effects of the COVID-19 lockdown on children in rural Bangladesh,” *Stud. Econ. 2102*, vol. 1, no. 305, pp. 1–26, 2021.
- [21] S. Cousins, “2.5 million more child marriages due to COVID-19 pandemic,” *Lancet (London, England)*, vol. 396, no. 10257, p. 1059, 2020, doi: 10.1016/S0140-6736(20)32112-7.
- [22] R. Guetto, D. Vignoli, and G. Bazzani, “Marriage and cohabitation under uncertainty: the role of narratives of the future during the COVID-19 pandemic,” *Eur. Soc.*, vol. 23, no. S1, pp. S674–S688, 2021, doi: 10.1080/14616696.2020.1833359.



# E-Gov, Realization Of Anti Corruption Policy (long journey to Era Society 5.0)

Amalia Syauket<sup>8</sup>

## Introduction

Data from the World Economic Forum (WEF) in the Global Competitiveness Report 2017-2018 [1] shows that corruption is the highest obstacle to doing business in Indonesia with a score of 13.8. This has resulted in high costs for doing business in Indonesia due to corrupt practices, creating legal uncertainty, inefficient allocation of resources and unequal economic distribution as well as creating unfair competition. In addition, the factors that hinder business in Indonesia are the inefficiency of the government bureaucracy with a score of 11.2, access to financing with a score of 9.2, and inadequate infrastructure with a score of 8.8. The fifth inhibiting factor is the instability of the policies made by the government with a score of 8.6. Meanwhile, government instability and the tax ratio rank next with 6.5 and 6.4 respectively.

The impact of corruption on the economy is very clear, such as sluggish economic growth and investment. Corruption has made economic development difficult by creating distortions and high inefficiencies. In the private sector, corruption increases the cost of trading due to losses from illegal payments, management costs in negotiating with corrupt officials and the risk of cancellation of agreements due to the investigation process. The infographic below illustrates this.



<sup>8</sup> amalia.syauket@dsn.ubharajaya.ac.id

Sumber:<https://www.google.com/search?q=hambatan+dalam+kemudahan+berusaha>. Di akses tgl.11 November 2021

Still in the economic field, corruption has also had an impact on decreasing income from the tax sector. The decline in income from the tax sector is exacerbated by the fact that there are many unscrupulous employees and public officials who play for personal gain and enrich themselves. Various reasons for investors to flee Indonesia include the complexity of licensing, not yet maximal use of the online single submission or electronic licensing system, policy inconsistency, and the absence of synergy between the center and the regions.

Robert said from the results of a survey conducted by KPPOD, this investment barrier also occurs in big cities and even Jakarta. "As a major business city and representing Indonesia in the World Bank's annual Ease of Doing Business study, it is not only less conducive and competitive with other cities at the regional level but also worse domestically when compared to Medan, Makassar, Balikpapan and Surabaya," said Robert [2].

Furthermore, according to Robert, urgent improvements need to be made to the licensing bureaucracy services at the central and local government levels. The technological support inherent in institutional reform is believed to be able to facilitate the implementation of improved licensing service processes in the regions. "Cutting bureaucracy and regulations need to be supported by improving business processes," said Robert [2]. According to Tan Kong Yam [3], investors are currently observing how the provincial government is simplifying investment procedures. For them, regulatory reform alone is not enough.

The concept of e-government is commonly known as e-gov, digital government, online government or transformational government. E-gov is an effort to develop electronic-based government administration. An arrangement of management systems and work processes within the government environment by optimizing the use of information and communication technology in the context of efficiency and effectiveness of local government administration, as well as government transparency.[13]

## **Discussion**

### **Bureaucratic transformation towards the era of society 5.0.**

In order to support the process of reform and transformation of the bureaucracy, it is necessary to develop an ICT-based government, for that it is necessary to change the role and

commitment of the bureaucracy as the main actor and controller of the course of government, development and public services. If the condition of the bureaucracy is not in accordance with the needs of ICT-based government, then the bureaucracy as an organization must be reformed immediately. However, political reform is not a guarantee that the Indonesian people will be willing and able to carry out bureaucratic reform. Everything depends on the political will and sincere intention that bureaucratic reform is to improve the quality of the bureaucracy in carrying out its role [13].

In order to support the task of reform, an ICT system is applied in public services. For this reason, a visionary leader is needed, who is able to develop effective leadership that can shape the vision and mission, can inspire enthusiasm and inspire subordinates to develop initiative and creativity, and maintain their responsibilities. Commitment and support from the leadership are important indicators for the successful implementation of e-government in Indonesia.

The definition of transformation put forward by Bram Klievink, 2009 in Nurmandi [13], transformation is a complex problem to which no universal approach exists and for which different types of models can be used. This means that transformation is interpreted as something complex with various approaches and various models used. One way to transform the bureaucracy is to apply communication and information communication technology (Kumorotomo, 2008, Heeks and Baqilur, 2007, Khan et al., 2011, Yildiz, 2007 in Nurmandi [13]).

In the last few decades, many studies have focused on linking ICT systems with good governance. So with the application of ICT in governance, a transparent, accountable and participatory government will be created [13].

Nurmandi, 2020 [13] explains that bureaucratic reform is not only limited to organizational structures, procedures or processes, but also to organizational strategic policies and policies. For this reason, a set of policies is needed in order to encourage the success of these innovations, including the following policies:

1. policies that can create a political climate that encourages risk-taking within the government bureaucracy.
2. policies that encourage local initiatives
3. Policies that place business goals in public services.

Thus, e-government means that all processes carried out by the government in making various policies and in providing services to the community are carried out using intensive information

technology while still considering humanities aspects of the problem solving process in the public sector.

### **E-Gov as a Policy to reduce corruption**

Indonesia is currently undergoing a fundamental change in the life of the nation and state towards a transparent democratic system of government and the rule of law. The changes that are being experienced provide opportunities for structuring various aspects of national and state life, where the interests of the people can be put back in a central position. However, every change in the life of the nation and state is always accompanied by various forms of uncertainty. Thus, the government must strive for smooth communication with high state institutions, local governments and encourage participation of the wider community, so that uncertainty does not lead to widespread disagreements and tensions, and has the potential to cause new problems. The government must also be more open to the swift flow of people's aspirations and be able to respond quickly and effectively.

The changes that are being undertaken occur at a time when the world is undergoing a transformation into the information society era. The rapid advancement of information technology and the potential for its wide use, opens up opportunities for fast and accurate access, management, and utilization of large volumes of information. The fact has shown that the use of electronic media is a very important factor in various international transactions, especially in trade transactions. The inability to adapt to global trends will bring the Indonesian people into the digital divide, namely isolation from global developments because they are unable to utilize information.

Thus, e-government development is an effort to develop government administration based on (using) electronics in order to improve the quality of public services effectively and efficiently. Through the development of e-government, management systems and work processes are arranged in the government environment by optimizing the use of information technology.

The implementation of E-Gov in various public services as an innovation strategy in government organizations clearly requires proper change management for its success [13]. Implementing E-Gov means carrying out a series of cultural changes or reforms (Cultural change). Change management in this context is focused on various stakeholders in public services entering a transition period from traditional approaches to modern management, from the era of pre-technology and communication technology to a new era where the environment is always changing rapidly through the development of

very sophisticated information and communication technology. , Riley, Thomas B, 2003 in Nurmandi [13]. This condition requires a personal bureaucracy with a culture of information and technology in carrying out the role of the bureaucracy. This is done in order to realize an open government system, which is characterized by transparency, participation and collaboration with the private sector according to the White House, 2009 [20]. Because implementing e-gov means carrying out a series of cultural changes or reforms.

In general, various cities in Indonesia have begun to implement e-Government, since its presence in the late 90s, which is called the phenomenon of Electronic Government (e-Government) which requires government agencies to ensure that there must be operational transformation in the field of public services. This is in line with the opinion of Dwiyanto [5] that the government bureaucracy can develop the use of information and communication technology (ICT) in the implementation of government activities, facilitate interaction with the community, and encourage accountability and transparency of public service providers.

E-government (e-gov) is essentially the process of utilizing technology as a tool to help run the government system more efficiently. Therefore, there are two main things in the definition of e-government above; the first is the use of information technology (one of which is the internet) as a tool, and the second is the purpose of its use, so that the government can run more efficiently [6]. public. To face the challenges of the globalization era, the Republican government Indonesia has taken the initiative to make policies to utilize information technology to build an integrated electronic government for e good governance from the local government to the central level [6].

Presidential Instruction No. 3 of 2003 dated June 9, 2003 concerning the National Policy and Strategy for the Development of E-Government can be used as a basis for local governments to implement government by implementing e-Government, although the regions do not yet have specific rules regarding the implementation of eGovernment in governance, Kurnia et al. , 2017 [9]. E-Government has a model of relationship that is not limited only between government agencies and the community, but also the relationship between government agencies and businesses, as well as the relationship between government agencies and other government agencies.

Understanding E-Government in general is short for government electronics. E-Government is commonly known as e-gov, digital government, online government or transformational

government. E-Government is an effort to develop an electronic-based government administration. An arrangement of management systems and work processes in the government environment by optimizing the use of information and communication technology. Or E-Government is the use of information technology by the government to provide information and services for its citizens, business affairs, and other matters relating to government. e-Government can be applied to the legislature, judiciary, or public administration, to improve internal efficiency, deliver public services, or democratic governance processes. [4] The objectives of e-gov according to Anwar in Nurmandi [13] are:

- a. the creation of an electronic relationship between the government and the community so that they can access various information and services from the government,
- b. carry out repairs and improvements to public services in a better direction than what is currently running.
- c. support good governance and openness, d. increase local revenue.

As at ransitional policy, in addition to containing advantages that provide benefits, there are also disadvantages or weaknesses [4]. Advantages of E-Government for the people:

1. Better service to the community. Information can be provided 24 hours, 7 days a week, without having to wait for the office to open
2. Improved relations between the government, business people, and the general public. With openness [transparency], it is hoped that the relationship between various parties will be better. This openness eliminates mutual suspicion and resentment from all parties, reducing direct interactions that can be an indicator of deviation.
3. More efficient governance
4. Information and Communication Technology developed in government or called e-government makes it easier for people to access government policies so that programs launched by the government can run smoothly.
5. e-government can also support more efficient government management, and can improve communication between the government and the business and industrial sectors.

According to Nurmandi [13], the advantages that have been achieved in the field of information technology and technology are something we should be grateful for, because with these advances it will make it easier for humans to do the tasks that must be done. Information and communication technology developed in

government or what is called e-government can also support more efficient government management, and can improve communication between the government and the business and industrial sectors [13]. Meanwhile, the disadvantages of E-Gov for the community [4] include:

1. The more free people access government sites, the more opportunities for cyber crime to occur that can damage the ICT system in e-government
2. The main weakness about e-government is the lack of equality in public access to reliability, internet information on the web, and hidden agendas of government groups that can influence and bias public opinion.
3. The services provided by government websites have not been supported by an effective management system and work process because the readiness of regulations, procedures and human resource limitations greatly limits the penetration of computers into the government system.
4. The strategy is not yet established and the budget allocated for e-government development is not adequate
5. The gap in the community's ability to access the internet network. Therefore, it is not surprising that the benefits of implementing eGovernment for the prevention and eradication of corruption have not been felt in practice in local governments in Indonesia<sup>7</sup>.

Real examples of the application of E-Gov in the form of E-Government to Business (Government to Business Actors), for example in the licensing process for business establishment and investment, procurement of auctions by the government, and other activities that require online information for business actors.

Corruption is an act against the law by committing acts of enriching oneself or others, causing losses to state finances or the state economy (Law No. 20/2001). Not only causing state financial losses, corruption also has non-financial impacts, such as reducing the credibility of the government's accountability system, reducing public trust in the government and disrupting public services. [7] Efforts to eradicate corruption in Indonesia have not been carried out. Efforts to take action against perpetrators of corruption have been carried out by the government together with the Corruption Eradication Commission (KPK) and the judiciary. In addition, the government has also utilized information and communication technology (ICT) by building electronic government (e-Government) for public services [7]. The purpose of implementing e-Government is to reduce face-to-face meetings so that opportunities for corruption can be reduced or

even eliminated as stated by Kim et al., 2009 [8]; Bertot et al., 2010[9] Asorwoe, 2014 [10]; Nugroho, 2014[11]. Research by Nugroho, 2014, Kurnia et al., 2017[12] and Simarmata, 2017[14] found that the implementation of e-Government in government administration plays a role in increasing transparency and accountability, thereby facilitating public services and reducing corruption.

The success of the implementation of e-Government in eradicating corruption can be seen from the application of e-Budgeting applications in DKI Jakarta Province in the process of preparing the Regional Revenue and Expenditure Budget (APBD) for the 2015 fiscal year. plenary session of the discussion of the Draft Regional Revenue and Expenditure Budget (APBD). In fact, changes to budgets, activities and programs in each Regional Apparatus Organization (OPD) should be carried out in accordance with procedures and permits from the authorized officials. Uninterruptible Power Supply (UPS) in a number of sub-district and sub-district offices in West Jakarta due to the lack of supervision, so that the mode of budget swelling is easy to occur there. E-Budgeting provides an opportunity for the public to monitor any changes to the budget ceiling in the DKI Jakarta Provincial government, so that the practice of budget inflation and corruption does not occur there [6].

The implementation of e-Government has been proven to reduce opportunities for corrupt practices because there is good transparency and accountability there, so that opportunistic behavior from government officials can be reduced according to Klitgaard, [15]; Kim et al.[8]; Elbahnasawy [16]. Transparency and accountability are principles of good governance, according to Liu and Lin [17]. The function of e-Government to eradicate corruption in Indonesia is not yet optimal due to the low level of public participation and the professionalism of public officials which still need to be improved. In addition, the implementation of e-Government in Indonesia is mostly still at the preparation and maturation stage. The implementation of eGovernment must reach the utilization stage so that e-Government can be optimally used to eradicate corrupt practices in Indonesia.

In welcoming the era of society 5.0 or super smart society, adjustments are needed in various sectors. The birth of the bureaucratic reform policy can change the mindset of the government which previously tended to be rigid and self-oriented, to become public servants. Human resource development planning must be carried out appropriately by responding to various obstacles that occur as well as all forms of environmental change and developments



of the times, because technology is a means, while humans remain the main actors.

## **Conclusion**

Efforts to accelerate innovation are needed to support the achievement of national independence to increase the nation's competitiveness. The challenge of governance, in the current era, is not enough just as a conventional state administrator. Governance is not enough to apply the old ways. This is as a result of the increasingly competitive countries in the world, which are influenced by the strengthening of globalization and the presence of the industrial revolution 4.0. The challenge of change must be answered intelligently and adaptively by the government so that the existence of the State is maintained, progress is achieved, and welfare can be enjoyed.

Strengthening bureaucratic reform towards the era of society 5.0 in Indonesia is still experiencing obstacles related to the still dominant bureaucratic pathology, massive corruption practices and unpreparedness. the bureaucracy will use technology and information in public services to the community. The realization of e-gov policies to reduce corruption is still not running effectively, as evidenced by the many corruption cases, for example those related to construction permits, land transfer permits and business permits as well as the procurement of goods and services. . The e-gov policy is still at the informative and interactive stage. At the informative stage, the website only functions as a medium for uploading information related to routine activities carried out by the government. Meanwhile, in the interactive stage, internet and website technology are used for communication media between the government and its citizens, which is the beginning of a long journey towards society 5.0.

## **References**

- [1] <https://databoks.katadata.co.id/datapublish/2019/09/24/korupsi-penghambat-utama-investasi-di-indonesia>. di akses tgl.10 November 2021
- [2] <http://www.gatra.com/ekonomi-1/makro/162980-kppod-kemudahan-investasi-di-daerah-masih-jalan-di-tempat.html>. di akses tgl.10 November 2021.
- [3] <https://pontos.id/2017/11/21/turun-2-peringkat-kemudahan-berbisnis-jakarta-di-bawah-jawa-tengah/>. Di akses tgl.11 November 2021
- [4] <https://diskominfo.badungkab.go.id/artikel/17777pengertian-keuntungan-kerugian-e-government#:~:text=Pengertian%20E-Government,-E>

- Government%20merupakan%20kependekan%20dari%ronik  
%20pemerintah.%20E-  
Government%20biasa,%C2%A0Ada%20tiga%20model
- [5] wiyanto, Agus, Manajemen Pelayanan Publik. Yogyakarta. Gadjah Mada. University Press. 2011:181.
- [6] Willia Satiawati ,Patar Rumapea ,Jericho D. Pombengi “Implementasi Kebijakan E- government Dalam Penyelenggaraan Pelayanan Publik di Dinas Kependudukan dan Pencatatan Sipil Kabupaten Mamuju Provinsi Sulawesi Barat  
“[https://media.neliti.com/media/publications/74987-ID-implementasi-kebijakan-e-government- dala.pdf](https://media.neliti.com/media/publications/74987-ID-implementasi-kebijakan-e-government-dala.pdf). di akses tgl. 11 November 2021
- [7] Evi Maria, Abdul Halim,E-GOVERNMENT DAN KORUPSI: STUDI DI PEMERINTAH DAERAH, INDONESIA DARI PERSPEKTIF TEORI KEAGENAN,Ekuitas: Jurnal Ekonomi dan Keuangan p-ISSN 2548 – 298X Akreditasi No. 32a/E/KPT/2017 e-ISSN 2548 – 5024 DOI: 10.24034/j25485024.y2021.v5.i1.4789. diakses tgl.11 November 2021.
- [8] Kim, S., H. J. Kim, dan H. Lee. 2009. An Institutional Analysis of an e-Government System for Anti-Corruption: the Case of OPEN. *Government Information Quarterly* 26(1): 42–50
- [9] Bertot, J. C., P. T. Jaeger, dan J. M. Grimes. 2010. Using ICTs to Create a Culture of Transparency: e-Government and Social Media as Openness and Anti-Corruption Tools for Societies. *Government Information Quarterly* 27(3): 264–271
- [10] Asorwoe, E. 2014. Can E-Government Mitigate Administrative Corruption ? An Empirical study into the Potential Role of E-Government in Eradicating Administrative Corruption in SubSaharan Africa What is Corruption? *Global Journal of Interdisciplinary Social Sciences* 3(4):41–47.
- [11] Nugroho, E. 2014. Pemanfaatan Teknologi Informasi Dalam Rangka Memberantas Tindak
- [12] Pidana Korupsi Secara Elektronik. *Jurnal Dinamika Hukum* 14(3): 539–546
- [13] Kurnia, T. S., U. Rauta, dan A. Siswanto. 2017. E-Government Dalam Penyelenggaraan Pemerintahan Daerah Di Indonesia. *Masalah-Masalah Hukum* 46(2): 170–181.
- [14] Achmad Nurmandi dkk, *Teknologi Informasi Pemerintahan*, UMY Press, Yogyakarta, 2020 [14]. Simarmata, M. H. 2017. Peranan eGovernment dan Media Sosial untuk Mewujudkan Budaya Transparansi dan Pemberantasan Korupsi. *Jurnal KPK: INTEGRITAS* 3(2): 203–229.

- [15] Klitgaard, R. 1988. Controlling Corruption. University of California Press. Berkeley. [16].Elbahnasawy, N. G. 2014. E-Government, Internet Adoption, and Corruption: An Empirical Investigation. *World Development* 57: 114–126.
- [16] Liu, J. dan B. Lin. 2012. Government Auditing and Corruption Control: Evidence from China's Provincial Panel Data. *China Journal of Accounting Research* 5(2): 163–186.

# **Use of Voice Recognition of "Cake" Android-Based Application to Improve Student's Pronunciation**

Amaluddin, Mutiah Nur Adzra, Siti Hajar Larekeng

## **Introduction**

In the midst of the times, technology is developing rapidly and the need for mastery of English is also increasing. Dependence on English as an international language is unavoidable, all people really need English as an international communication tool. It starts with the general public, workers, intellectuals, parents, teachers, and especially students who must indirectly understand this language, although not in its entirety. Students themselves admit that English must be mastered with a deeper understanding, it directs them to practice it inside and outside the classroom, as active users, not passive users [3]. One of the latest technologies that are widely used in various aspects today is the use of Artificial Intelligence (AI hereinafter abbreviated). AI is a part of a computer that can do a job as well and accurately as humans do. If in the past computers only functioned as automatic typewriters or calculators, now computers can do more than that, they can do things as well as humans do [6]. AI has several advantages over natural intelligence possessed by humans, AI works permanently while natural intelligence is easily changed due to forgetfulness in humans.

Pedagogically, the involvement of AI speech recognition greatly contributes to teaching and learning speaking. Problems that commonly faced by the students in the high school level is in the field of pronunciation, they got hardly to pronounce the English word or sentences correctly even though the teacher has given examples of the correct pronunciation of the wor [4]d. In the last semester, when the researcher was teaching the last material, namely English song lyrics related to the lives of teenagers, more than half of the students scored below the KKM standard (75), they got a score of 60-65. This is because some students choose not to do the assigned task which is singing English songs. They choose not to do it because of the reason that they lack of English pronunciation. They feel shy and unconfident because of their pronunciation. Psychologically, it will make students feel that learning English is difficult and they do not find learning language are interesting and fun. In other words, they feel unmotivated to learn English beyond [1].

Based on the teaching experience conducted by researcher in grade X and XI, there are several types of pronunciation that are

difficult for students to pronounce. They have difficulty in pronouncing some vowels and consonants. In vowel form, such as diphthong (sight, mouse, toy); central vowel (earth, teacher, nut); tense vowel (palm, thought, nurse, goose, fleece). Meanwhile, in consonant form, such as the -ed ending of verbs (stopped, liked, robbed, saved, wanted, hated); consonant combinations (accent, chain, bridge, science, scissors, share); with silent letter (doubt, debt, knife, wrap, wreck, wrong); letter in the suffix (nation, patient, measure, pleasure) [5]. Moreover, several teacher admitted that affective factor such as low of self-confidence contribute to the students' pronunciation error. The researcher concluded that most of the teachers found same problems among their students. Teaching pronunciation in an old-fashioned way affect their motivation in learning English pronunciation.

The researcher conducted a survey to determine the causes of students' poor pronunciation. There were 42 students involved from SMA Negeri 9 Wajo, 26 students from X grade and 26 students from XI grade. Based on the survey results, 64.4% of students agreed that they became less enthusiastic about learning English pronunciation because of the media used by the teacher is not interesting, so the students were unable to pronounce English words or sentences correctly. In order to solve the problem, the researcher will involve an Android-based application. Cake is an Android based application with ASR features that famously used by the EFL digital users. Besides presenting learning English with fun, this application has also become their virtual assistant in learning languages that can be used every time and everywhere. This application is a sophisticated ASR that has been downloaded by 50 million users through Play Store and 11 million users through the App Store. It offers various features that can be used by all English learners [7].

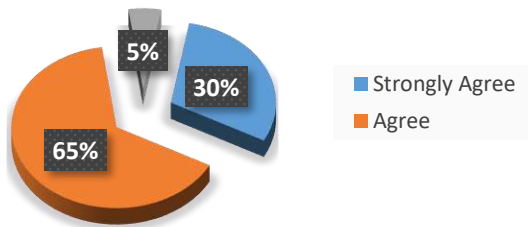
Focusing on real English learning through video, this application presents an audio visual interface that will make it easier for students to listen and watch various English videos and record their voices to practice pronouncing the sentences that are heard in the video. The main problem that has been described in the previous section is that the final grades of students do not meet the standards of expected learning outcomes, especially on material that emphasizes mastery of good English pronunciation [11]. Likewise, the limitations of learning applications when teaching pronunciation are used by teachers, so that in the end it makes pronunciation learning look boring and unattractive to students. Therefore, the researcher attempted to answer the question as to how are students' perceptions of AI Speech Recognition "Cake" Android-based applications in

improving their pronunciation skills at SMAN 9 Wajo? This is very important to mention so that students can be helped in good pronunciation in English [2].

### Findings

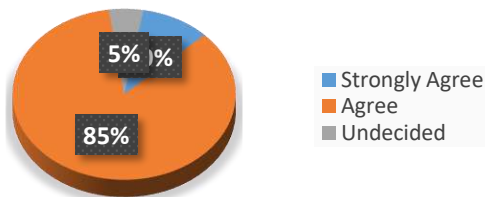
How are the students' perceptions about AI speech recognition Cake Android-based application boosting their pronunciation ability in SMAN 9 Wajo ? The researcher distributed questionnaire to know students' perception toward Cake Android-based application in boosting students' pronunciation ability. The data was analyzed by using Likert Scale.

- a. Cake app helps students pronounce the letters correctly  
Most of the students agree that this application help them to pronounce letters correctly. There were 30% students strongly agree, 65% students agree, and 5% students undecided.



**Figure 2. Cake helps students pronounce the letters correctly**

- b. Cake application helps students pronounce consonant correctly  
In this statement, there were only 3 statements answered by the students; strongly agree, agree, and undecided. There are 10% students answered strongly agree, 85% students answered agree, and the rest of students, 5% answered undecided.



**Figure 3. Cake helps students pronounce the consonants correctly**

- c. Cake application helps students pronounce vowel sounds correctly.

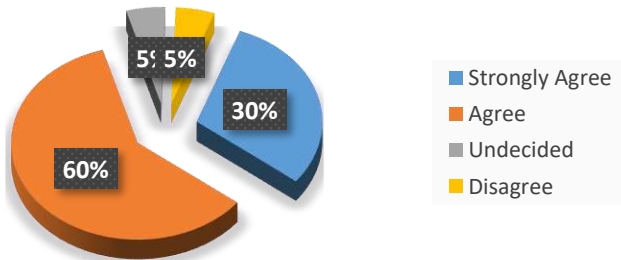
All the students agreed that this application helps them to pronounce vowel (single vowel sound) correctly. There were 35% students strongly agree and 65% students agree.



**Figure 4. Cake helps students pronounce the vowel correctly d**

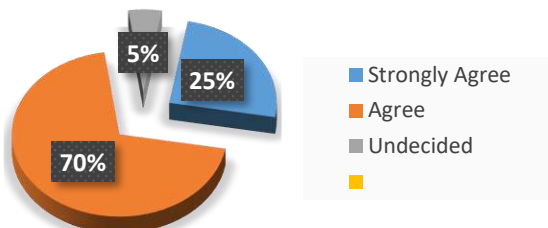
- d. The cake application helps students pronounce the diphthong sounds correctly.

There were 30% students strongly agree, 60% students agree, 5% students undecided, and 5% students disagree.



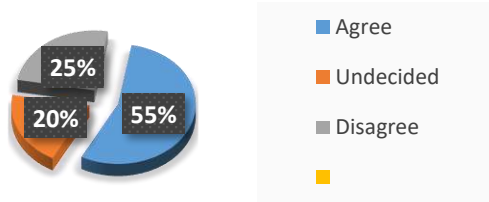
**Figure 5. Cake helps students pronounce diphthong sounds correctly**

- e. Cake application helps students pronounce sentences correctly. Almost all the students agreed that this application helps them to pronounce sentences correctly. There were 25% students strongly agree, 70% students agree, and 5% students undecided



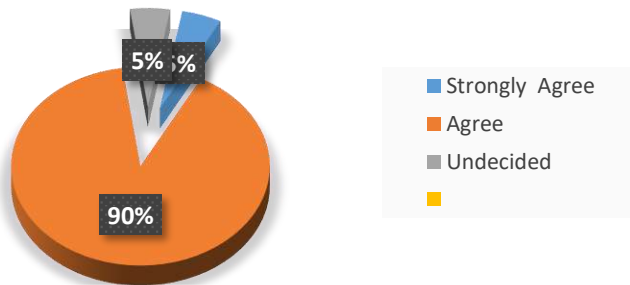
**Figure 6. Cake helps students pronounce sentences correctly**

- f. Cake application helps students reduce first language accent. First language accent is not easy to reduce because it formed by habituation by its speaker. Relating to this, there were 55% students agree, 20% students undecided, and 25% students disagree



**Figure 7. Cake helps students reduce their first language accent**

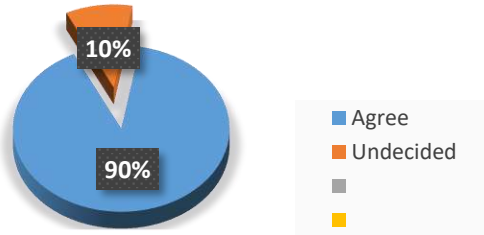
- g. Cake application helps students reduce nervousness when pronouncing words/sentences in English. Most of the students agree that this application can reduce their nervousness. There were 5% students answered strongly agree, 90% students answered agree, and 5% students answered undecided.



**Figure 8. Cake application helps students reduce nervousness**

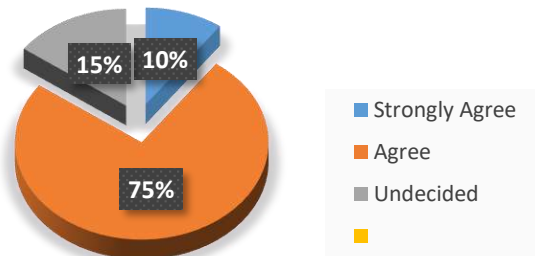
- h. Android-based Cake application helps me reduce anxiety when pronouncing words/sentences in English. All of the students agree that this application can reduce their nervousness. There were 10% students answered strongly agree, 90% students answered agree.





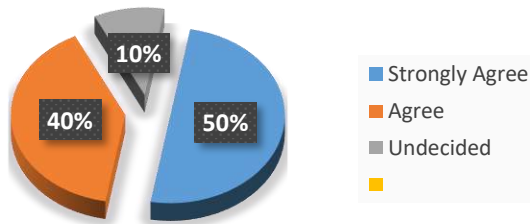
**Figure 9. Cake application helps students reduce anxiety**

- i. Cake application helps students to increase confidence when pronouncing words/sentences in English. Most of the students agree that this application can increase confidence when pronouncing words/sentences in English. There were 10% students answered strongly agree, 75% students answered agree, and 15% students undecided.



**Figure 10. Cake application increase students' confidence**

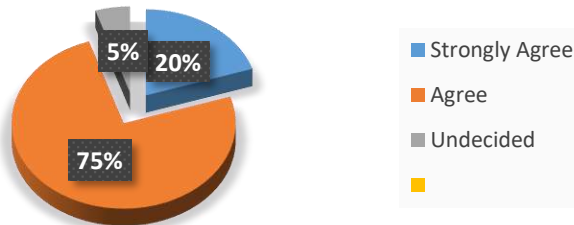
- J. Cake application is an easy application to learn pronunciation. Most of students agree that this application is an easy application to learn pronunciation. There were 50% students answered strongly agree, 40% students answered agree, and 10% students answered undecided.



**Figure 11. Cake application is an easy application**

- k. Cake application has complete features to use for learning English pronunciation.

Most of students agree that this application has complete features to use for learning English pronunciation. There were 20% students answered strongly agree, 75% students answered agree, and 5% students answered undecided.



**Figure 12. Cake application has complete features**

### Discussion of Research Results

The researcher measured the students' perception by distributing questionnaire to the students. There are 11 questions in total related to the use of Cake Android-based application. The first until five questions asked about how this application improve students' pronunciation ability when pronouncing letters, consonants sounds, vowels sounds, diphthong sounds, and sentences. The result of questionnaire showed that more than a half of students agreed that Cake Android based-application solved their pronunciation problems related to the aspect mentioned above. In line with this, according to [10] students often made errors in vowels, consonants, and diphthongs. These kinds of errors commonly found when students practice their pronunciation ability but by the existence of great features of Cake, students can decrease more their pronunciation

errors. Cake serves hundreds of channels that consist of English video with the pronunciation of native speakers. Students watched and repeated more the videos and followed its correct pronunciation [6].

In the question number six, 55% students agreed that this application helped them to reduce their first language (L1) accent when pronouncing English word/sentences. This could be happened because Cake provides pronunciation of native speakers in their key features, for instance, students can watch English videos with the native speaker's pronunciation (American pronunciation) and repeat it many times, so it will affect and reduce their L1 accent [13].

Meanwhile, question number seven to nine asked about how the students feel when using the application. There were 90% students agreed that this application get rid their nervousness when pronouncing English word/sentences, 90% students agreed that using this application reduce their anxiety when pronouncing English word/sentences, and 75% agreed that this application make them feeling confidence when pronouncing English word/sentences. In line with this, Cake application used by [15] in teaching speaking to Senior High School students by using qualitative method. All the key features of Cake is created to collect enjoyment and comfort from the EFL users by visualizing the features with fun and interesting visual. The students feel that they do not learn pronunciation like the way they learn conventionally in the classroom, but they feel that using Cake make them enjoy and feeling like playing games while learning pronunciation, so students can reduce their anxiety and nervousness, and make them feel more confidence when pronouncing word or sentences. However [12] investigated factors contributing to the students' pronunciation errors. It was categorized into internal factors, external factors, and interlingual factors. The internal factors include less preparation and practicing on performing speech and anxiety of performing the speech. External factors cover lack of time and opportunity to use English in daily lives, whereas interlingual factor is the interference from the mother tongue. Students own some factors that contributing to their pronunciation ability, but the good and enjoyable features of Cake make the students can get rid some of the factors, especially internal and interlingual factors [14].

Moreover, question number ten asked about the effectiveness of the application. There were 50% students answered that this application is easy to use. Cake application can be used in many languages, so students could change it into their first language (L1) if it makes them easier to understand the instruction of the application. Moreover, each feature of Cake has easy instruction to use because it is similar settings and instruction with other commonly used

application such as Youtube, Facebook, and any other learning application of Android [8].

In question number eleven, there were 75% students agreed that this application has complete features that can help students to improve their pronunciation ability. The all key features of Cake is very helpful to boost their pronunciation ability. Students can get direct correction of their pronunciation after their voice is processed by the application. Beside of that, students get their personal assistant of pronunciation that can help them to practice their pronunciation anytime anywhere. This feature made by a form of conversation of daily life, so the students get easier to engage and understand the conversation. These kind example of Cake features, there are many more features that help students to improve their pronunciation ability [9].

## Conclusion

Based on the analysis of questionnaire, there are some perceptions of students toward the Cake Android-based application. Most of students agree that this application help them to pronounce letter, consonant, vowel, diphthong, and sentences correctly, reduce students' first language accent, nervousness, and anxiety, increase students' confidence. Besides that, this application also easy to use for the students and has complete features to learn pronunciation. In conclusion, based on the explanation above, the researcher concluded that students give positive perceptions toward the Cake Android-based application which means they are feeling very helpful with the involving of the application in order to boost their pronunciation ability.

## References

- [1] Azkia, N. S (2021, June 18). Cake app Reviews. Retrieved from Google Play: [https://play.google.com/store/apps/details?id=me.mycake&hl=en\\_US&showAllReviews=true](https://play.google.com/store/apps/details?id=me.mycake&hl=en_US&showAllReviews=true)
- [2] Fraser, H., & Perth, H. F. (1999). *ESL pronunciation teaching: Could it be more effective*. Australian Language Matters, 7(4), 7-8
- [3] Gavran, S. (2013). *The Importance of English Language Learning and Teaching in South Korea*.
- [4] Gerber, C. (1995). A general approach to speech recognition. *In Proceedings of the Final Workshop on Multimedia Information Retrieval (Miro'95)* (pp. 1-12).
- [5] Gilbert, J. B. (2008). *Teaching pronunciation: Using the prosody pyramid*. New York, NY: Cambridge University Press.

- [6] Jaya, H., Sabran, Idris, M. M., Djawad, Y. A., Ilham, A., & Ahmar, A. S. (2018). *Kecerdasan Buatan*. In Fakultas MIPA Universitas Negeri Makassar.
- [7] Kamendakal, A (2021, July 02). Cake app Reviews. Retrieved from Google Play: [https://play.google.com/store/apps/details?id=me.mycake&hl=en\\_US&showAllReviews=true](https://play.google.com/store/apps/details?id=me.mycake&hl=en_US&showAllReviews=true)
- [8] Kim, I. S. (2006). Automatic speech recognition: Reliability and pedagogical implications for teaching pronunciation. *Journal of Educational Technology & Society*, 9(1), 322-334
- [9] Lawrence, R., & Juang, B. H. (1993). *Fundamental of Speech Recognition Prentice-hall International*.
- [10] Lestari, D. D., Suryani, F. B., & Nuraeningsih, N. (2020). *Pronunciation Errors Made by EFL Student Teachers in Speech Performance*. *Prominent*, 3(2).
- [11] Moreno, A. I., & Vermeulen, A. (2015). Using VISP (Videos for Speaking), a mobile App based on Audio Description, to promote English Language Learning among Spanish Students: a case study. *Procedia-Social and Behavioral Sciences*, 178, 132-138.
- [12] Silalahi, R. M. P. (2017). Pronunciation problems of Indonesian EFL learners: An error analysis. *Journal of English Language and Culture*, 6(2).
- [13] Sugiyono, D. (2008). *Metode penelitian bisnis*. Bandung: Pusat Bahasa Depdiknas.
- [14] Tsai, P. H. (2006). Bridging pedagogy and technology: User evaluation of pronunciation oriented CALL software. *Australasian Journal of Educational Technology*, 22(3).
- [15] Yanthi, W. (2021). The Use of Cake Application in Teaching Speaking to Senior High School's Students. *In Bogor English Student and Teacher (BEST) Conference* (Vol. 2, pp. 165-170).

# Combination of Curcumin and Honey as Supporting Therapy for Typhoid Fever in Children

Ami Febriza<sup>9</sup>

## Introduction

Typhoid fever is one of the most common diseases in children. The prevalence of typhoid disease in the world reaches 21 million cases, with a figure of deaths reaching 128,000-161,000 [1]. The highest cases occur in Asian countries, especially developing countries. That is because developing countries tend to have poor sanitation. Meanwhile, the number of cases of typhoid fever in Indonesia is estimated to reach 900,000 per year [2].

Typhoid fever is a systemic infection caused by the bacteria *Salmonella typhi* (*S. Typhi*) and *Salmonella paratyphi* (*S. Paratyphi*) [3]. Some of the symptoms that can arise, include fever that rises periodically, headache, abdominal pain, nausea, vomiting, constipation or diarrhea, relative bradycardia, hepatosplenomegaly, and leukopenia [2]. When our body is infected with *S. Typhi*, our body will hold out in response to the innate immunity response. A special marker molecule of a Gram-negative bacterium is lipopolysaccharide (LPS), which is immediately recognize by protein receptors on the host, which is the toll-like receptor 4 (TLR-4) receptor, TLR-4 binds to LPS [4].

The primary treatment for typhoid fever in children is using antibiotics. Antibiotics work by inhibiting growth of bacteria. However, long-term use of antibiotics can lead to bacterial resistance. *S. Typhi* was reported to be resistant to antibiotics known as Multiple Drug Resistant (MDR), which occurred first in 1974 [5], [6]. In view the high morbidity of typhoid fever, an increasing number of relapses, and cases of MDR *S. Typhi* bacteria, attempts to combine the antimicrobial agent and herbal remedies have attracted great interest.

Curcumin and honey are compounds that have been proven to have antibacterial effects. There is a body of evidence that suggest that curcumin can induce the expression of antimicrobial peptide, Cathelicidin, through a vitamin D receptor-independent pathway [7].

---

<sup>9</sup> University of Muhammadiyah Makassar, [amifebriza@med.unismuh.ac.id](mailto:amifebriza@med.unismuh.ac.id)

Evidence from other studies suggest that curcumin works by denaturing or destroying bacterial cell membrane so that the cell metabolism process in bacteria is disrupted and effect bacterial death [8], [9]. A recent study conclude that there was evidence to support that honey also had antimicrobial effect. Honey has antibacterial properties, especially against multidrug-resistant (MDR) *S. Typhi* [10].

## **Discussions**

### **Typhoid Fever**

*S. Typhi* and *S. Paratyphi* are bacteria that spread through the fecal-oral route. These bacteria will enter the human body through the mouth along with food or drink. After the bacteria enter the mouth, the bacteria will go to the stomach. However, not all bacteria can pass through the stomach, some bacteria will die when exposed to stomach acid, which is the body's barrier or immune system, and the remaining bacteria will continue to the small intestine. Bacteria will return to the circulatory system, cause bacteremia. The bacteria will travel to the spleen, stomach, and bile, causing several effects. In the stomach, bacteria will cause stomach acid to increase. While in the spleen and bile will cause pain. This causes nausea and vomiting, which results in decreased appetite so that nutrition is not balanced. Bacteria will enter the small intestine, proliferate, and release endotoxins that cause inflammation of the body. This inflammation triggers the hypothalamic thermoregulatory center to increase the temperature. An increase in temperature causes symptoms of hyperthermia or fever [11].

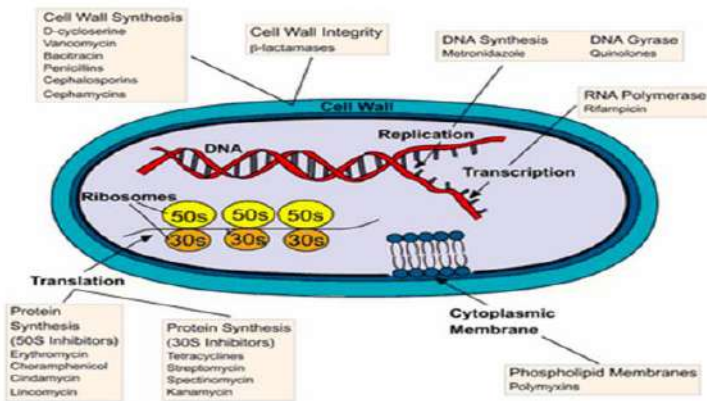
Typhoid fever has an incubation period of 10-14 days. Acute typhoid fever has systemic symptoms in the form of fever, both gradually and continuously. Other symptoms that dominate are fever for more than a week and fluctuating (30-100%). Fever will increase at night and decrease in the morning. This is due to the activity of *Salmonella typhi* bacteria (*S. Typhi*) being more active at night. Furthermore, headache (43%-90%), gastrointestinal symptoms in the form of abdominal pain; nausea and vomiting; and constipation or diarrhea (30%). Other non-specific symptoms include chills, muscle aches, dizziness, coughing, weakness, sore throat, and anorexia. Typhoid fever also causes Gastrointestinal disorders such as halitosis (bad breath), cracked and dry lips, and meteorismus [12], [13].

Typhoid fever often occurs in children aged 5-9 years and also infants. School-age children have a higher risk of developing typhoid fever. This is because school-age children tend to choose snacks indiscriminately with poor hygiene. Typhoid fever is also more

common in men than women. This is because the presence of the X chromosome will provide immunity against infection [14].

Typhoid fever in children is influenced by two factors, namely internal and external factors and external. Internal factors come from a person's habits and cleanliness, such as snacking carelessly and washing hands before eating. Snacks indiscriminately have a higher chance of contamination by *Salmonella* bacteria. Furthermore, external factors can be caused by an unsanitary lifestyle, such as inadequate clean water supply, dirty or polluted water, latrines that do not meet standards, and littering that facilitates the spread of bacteria. Another external factor is economic problems. The low economy causes the quality of food, shelter, and other facilities to be low to increase the spread of the bacteria [15].

Treatment of typhoid fever is focused on stopping the growth of *S. Typhi*. The most common treatment in Indonesia currently with antibiotics. Antibiotics that are often given are ciprofloxacin because the antibiotic can penetrate macrophages and strains that are resistant to many drugs. Other often used antibiotics are chloramphenicol, amoxicillin, fluoroquinolone, and cephalosporin [3].



**Figure 1. Diagram showing target sites of antimicrobial agents**

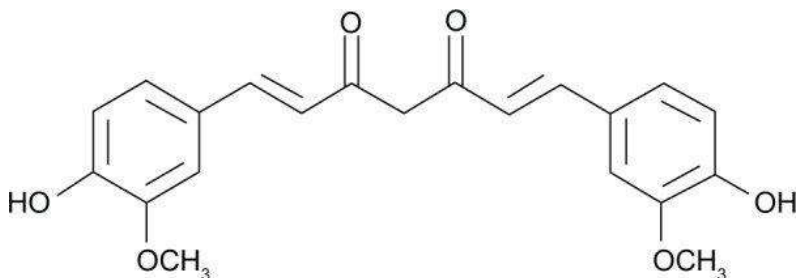
Antibiotic resistance has been around as long as antibiotics are applied to treat infection. This may have been addressed by previous studies that explain the mechanisms of antimicrobial resistance for *S. Typhi* infection. Bacteria can resist the effects of antibiotics by inactivation of the antimicrobial agent, efflux or transport of the antimicrobial agent, modification of the antimicrobial



site and decreased permeability of the antimicrobial agent [3]. These resistance properties cause bacteria to will not work if given antibiotics with the same dose continuously so that its effectiveness decreases.

### Curcumin

Curcumin is a compound found in the turmeric plant. This plant is widely distributed in Southeast Asia. *Turmeric* is a plant with anti-microbial, anti-fungal, antioxidant, and anti-inflammatory properties[16]. Curcumin works by denaturing or destroying bacterial cell membrane so that bacteria's cell metabolism process is disrupted and affects bacterial death [8]. The results of the study adds to the growing body of evidence that curcumin had antimicrobial activity [9], [17]. Curcumin can also bind to vitamin D receptors and stimulate the expression of an antibacterial protein called Cathelicidin [7]. This clearly demonstrated the consistency with other study that given curcumin with dose 200 mg/kg and 400 mg/kg can promote and induced expression of Cathelicidin antimicrobial peptide (CAMP) mRNA gene [18].



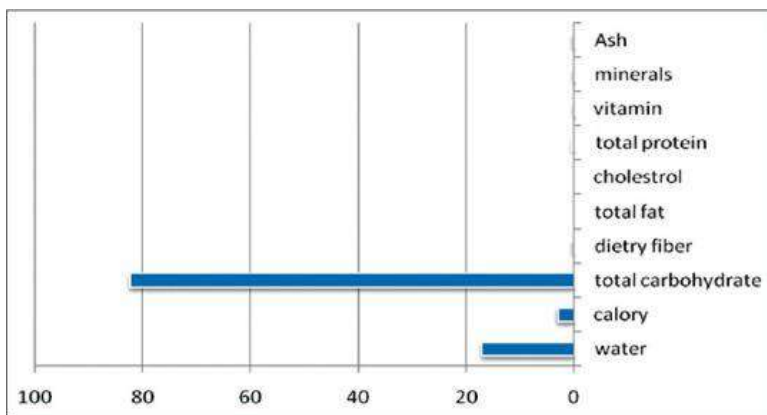
The mechanism of curcumin as an antimicrobial begins with curcumin binding to the Vitamin D Receptor (VDR) as a potential ligand. In addition after binding with VDR, curcumin will induce the mRNA expression of CAMP. This binding causes formation and an increasing the level of Cathelicidin in the tissues [18].

### Honey

Honey is a natural product formed from nectar of flowers by bees and has been used for several countries [20]. There are numerous evidences in the literature regarding the effects of honey as antioxidant [21], antibacterial [22], anti-inflammatory, anti-diabetic[23], and protective effect for system digestive health [24].

The highest honey content is carbohydrates which consist of 95-97%. The fructose and glucose content can draw water from the

lumen of the digestive tract to return to the bloodstream, increasing the rate of absorption. As the rate of absorption increases, the waste of fluids and electrolytes can be prevented, thereby reducing the symptoms of diarrhea caused by *S. Typhi*. In addition, honey contains other major compounds, such as proteins, vitamins, amino acids, minerals, and organic acids [25].



**Figure 3. Composition of average amount per 100 gram honey**

Honey has benefits as an antibacterial, especially against multidrug-resistant (MDR) Salmonella Typhi. MDR is resistant to all types of antibiotics. The pro-inflammatory properties of honey can suppress the production of free radicals in the body so that *S. Typhi* can be killed. The decrease in the number of free radicals causes fever due to inflammation to decrease [10].

### Conclusions

As discussed in the previous section, we concluded that the combination of curcumin and honey could possibly as adjuvant for treating typhoid fever caused by *S. Typhi*. The combination of the two agents is expected to be able to treat the symptoms of typhoid fever more effectively in children because it is easy to consume.

### References

- [1] R. Dwiyanti *et al.*, "Seroprevalence Rates of Typhoid Fever among Children in Endemic Areas, South Sulawesi, Indonesia," *Indian J. Public Heal. Res. & Dev.*, 2019.
- [2] A. Rabasa, Y. Mava, S. Pius, S. Timothy, and U. Baba, "Typhoid fever in children: Clinical presentation and risk factors," *Niger. J. Paediatr.*, vol. 40, no. 1, pp. 60–63, 2012, doi: 10.4314/njp.v40i1.11.

- [3] H. Ugboko and N. De, "Mechanisms of Antibiotic resistance in Salmonella typhi," *Int.J.Curr.Microbiol.App.Sci*, vol. 3, no. 12, pp. 461–476, 2014, [Online]. Available: <http://www.ijcmas.com>.
- [4] S. P. Abul Abbas, Andrew H. Lichtman, *Cellular and Molecular Immunology*, 8th ed. Philadelphia: W.B. Saunders Company, 2014.
- [5] R. M. Lampe, C. Duangmani, and P. Mansuwan, "Chloramphenicol- and ampicillin-resistant typhoid fever," *JAMA*, vol. 233, no. 7, p. 768, 1975, doi: 10.1001/jama.1975.03260070018007.
- [6] J. A. Crump, S. P. Luby, and E. D. Mintz, "The global burden of typhoid fever.," *Bull. World Health Organ.*, vol. 82, no. 5, pp. 346–353, May 2004.
- [7] C. Guo, E. Rosoha, M. B. Lowry, N. Borregaard, and A. F. Gombart, "Curcumin induces human cathelicidin antimicrobial peptide gene expression through a vitamin D receptor-independent pathway," *J Nutr Biochem*, vol. 24, no. 5, pp. 754–759, 2013, doi: 10.1016/j.jnutbio.2012.04.002.
- [8] P. Tyagi, M. Singh, H. Kumari, A. Kumari, and K. Mukhopadhyay, "Bactericidal Activity of Curcumin I Is Associated with Damaging of Bacterial Membrane," *PLoS One*, vol. 10, no. 3, p. e0121313, 2015, doi: 10.1371/journal.pone.0121313.
- [9] S. I. Rahayu, N. Nurdiana, and S. Santoso, "The effect of curcumin and cotrimoxazole in salmonella typhimurium infection in vivo.," *ISRN Microbiol.*, vol. 2013, p. 601076, 2013, doi: 10.1155/2013/601076.
- [10] M. B. Hussain *et al.*, "Evaluation of the antibacterial activity of selected Pakistani honeys against multi-drug resistant Salmonella typhi.," *BMC Complement. Altern. Med.*, vol. 15, p. 32, Feb. 2015, doi: 10.1186/s12906-015-0549-z.
- [11] D. House, A. Bishop, C. Parry, G. Dougan, and J. Wain, "Typhoid fever: pathogenesis and disease.," *Curr. Opin. Infect. Dis.*, vol. 14, no. 5, pp. 573–578, Oct. 2001, doi: 10.1097/00001432-200110000-00011.
- [12] Mimi Marleni, Yulia Iriani, Wisman Tjuandra, and Theodorus, "Ketepatan Uji Tubex TF® dalam Mendiagnosis Demam Tifoid Anakpada Demam Hari ke-4," *J. Kedokt. DAN Kesehat.*, vol. 1, pp. 7–11, 2012.
- [13] Tumbelaka, "Tata Laksana Demam Tifoid Pada Anak. Pediatrics Update. Naskah lengkap Pendidikan Kedokteran Berkelanjutan," *Ilmu Kesehat. Anak IDAI Jaya*, 2003.
- [14] I. Pinheiro, L. Dejager, and C. Libert, "X-chromosome-located microRNAs in immunity: might they explain male/female

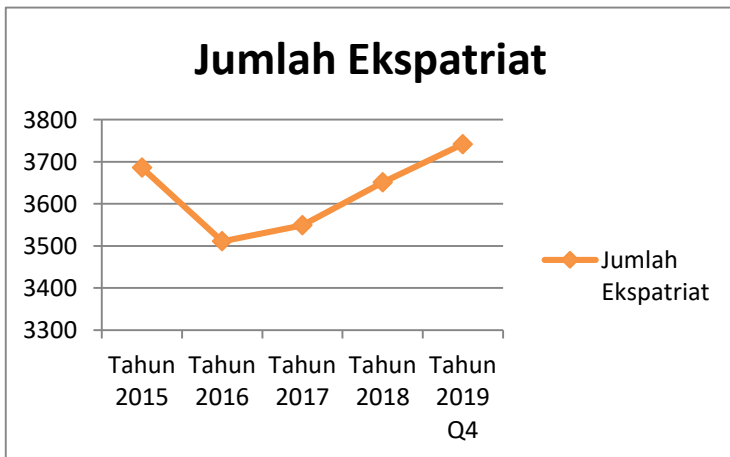
- differences? The X chromosome-genomic context may affect X-located miRNAs and downstream signaling, thereby contributing to the enhanced immune response of females.," *Bioessays*, vol. 33, no. 11, pp. 791–802, Nov. 2011, doi: 10.1002/bies.201100047.
- [15] T. Ogunbiyi and B. Onabowale, "Typhoid enteritis in Lagos, Nigeria.," *Niger. Med. J.*, vol. 6, pp. 505–511, 1976.
- [16] J. S. Jurenka, "Anti-inflammatory properties of curcumin, a major constituent of *Curcuma longa*: a review of preclinical and clinical research," *Altern Med Rev*, vol. 14, no. 2, pp. 141–153, 2009.
- [17] B. Herdiawan *et al.*, "In Silico Potential of Turmeric (*Cucurma longa*) as Antibacterial Agent for *Salmonella typhi*," *Bioedukasi*, vol. XVI, no. 2, p. 103, 2018, doi: 10.19184/bioedu.v16i2.9476.
- [18] A. Febriza *et al.*, "Curcumin effects in inducing mRNA gene cathelicidin antimicrobial peptide in Balb/c mice infected with *Salmonella typhi*," *J. Biol. Res. della Soc. Ital. di Biol. Sper.*, vol. 93, no. 2, 2020.
- [19] M. Farazuddin, B. Dua, Q. Zia, A. A. Khan, B. Joshi, and M. Owais, "Chemotherapeutic potential of curcumin-bearing microcells against hepatocellular carcinoma in model animals," *Int. J. Nanomedicine*, vol. 9, no. 1, pp. 1139–1152, 2014, doi: 10.2147/IJN.S34668.
- [20] T. T. Adebolu, "Effect of natural honey on local isolates of diarrhea-causing bacteria in southwestern Nigeria," *African J. Biotechnol.*, vol. 4, no. 10, pp. 1172–1174, 2005, doi: 10.5897/AJB2005.000-3233.
- [21] S. Ahmed and N. Othman, "Honey as a Potential Natural Anticancer Agent: A Review of Its Mechanisms," *Evid. Based. Complement. Alternat. Med.*, vol. 2013, p. 829070, Jan. 2013, doi: 10.1155/2013/829070.
- [22] W. Y. Attia, M. S. Gabry, K. A. El-Shaikh, and G. A. Othman, "The anti-tumor effect of bee honey in Ehrlich ascite tumor model of mice is coincided with stimulation of the immune cells.," *Egypt. J. Immunol.*, vol. 15, no. 2, pp. 169–183, 2008.
- [23] N. Ivanova, V. Gugleva, M. Dobрева, I. Pehlivanov, S. Stefanov, and V. Andonova, "Honey and type 1 diabetes mellitus," *Intech*, vol. i, no. tourism, p. 13, 2016.
- [24] S. Ghosh and R. J. Playford, "Bioactive natural compounds for the treatment of gastrointestinal disorders.," *Clin. Sci. (Lond.)*, vol. 104, no. 6, pp. 547–556, Jun. 2003, doi: 10.1042/CS20030067.
- [25] S. Samarghandian, T. Farkhondeh, and F. Samini, "Honey and health: A review of recent clinical research," *Pharmacognosy Res.*, vol. 9, no. 2, pp. 121–127, 2017, doi: 10.4103/0974-8490.204647.

# Employees Readiness Improvement Model to Face Changes in the Society 5.0 Era: Study on Indonesian Expatriates Abroad

Anggia Sari Lubis

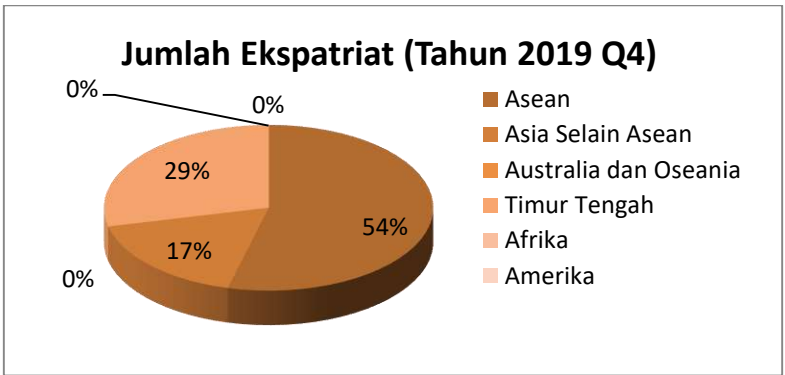
## Introduction

Globalization has created a borderless world that provides opportunities and challenges for human resources in obtaining jobs. The most significant opportunity for human resources in the current era of globalization and digitalization is the wide-open of information on job vacancies abroad, which provides job seekers from Indonesia opportunities to have a career abroad. An expatriate is someone who works abroad only temporarily or as a professional or expert. Globalization makes expatriation a common thing that multinational companies mainly do. One of the expected goals of this expatriation practice is to increase competence, especially managerial competence, on an international scale. The ultimate goal is to transfer knowledge to companies in their home countries [13]. Therefore, the number of expatriates tends to increase from year to year. Data on fluctuations in the number of expatriates in 2015-2019 are as follows:



**Figure 1. Number of Expatriate of 2015-2019 (Q4)**  
Source: Indonesian Bank and BNP2TKI

As presented in figure 1, the number of expatriates has increased in the 2017-2019 year period. One of the determinant factors is increasing digitalization and remote working, making flexible working space familiar. A flexible workplace is a concept of regulating employee work patterns that provide flexibility in working locations for a certain period. by maximizing information technology. Furthermore, countries with expatriates originating from Indonesia can be seen in the following picture:



**Figure 2. Number of Expatriate Based On Country of 2019 (Q4)**  
**Sumber: Bank Indonesia dan BNP2TKI**

According to Figure 2, there is observable that Indonesian expatriates commonly work in ASEAN and Asian countries other than ASEAN, including Malaysia, Singapore, Brunei Darussalam, Hong Kong, Taiwan, China, South Korea, Japan, and Macau. Based on interviews with 45 respondents, who are Indonesian expatriates, they choose ASEAN and Asian countries as work destinations due to some reasons, that is: 1) the location where is relatively near from Indonesia, 2) there are not significant cultural differences, and 3) a great opportunity of career progression which supported by competition that prospective workers from Indonesia can master.

Human resources who work in industries have to face changes, both employees who work for companies in Indonesia and companies abroad. Change is an event where something has a different result from the previous one Changes can occur to individuals depending on internal and external factors. In a personal context, change can be called personal change. In addition, the industrial revolution era attack is actual. Currently, companies worldwide are facing and adapting technological integration during industrial revolution 4.0, also preparing for the changes that the

Society 5.0 era will bring [7]. In this case, changes are also must be faced by the organization. Although it may seem easy, the change process in its implementation has proven to be a complex phenomenon and practice, especially for many companies studied during the last decade that are implementing organizational change initiatives [2].

Expatriates, which in this study focused on Indonesian workers working for foreign companies, certainly face many changes from external factors. However, based on the results of interviews with 38 expatriates from Indonesia who work abroad. It can be concluded that three primary factors make the most significant changes for expatriates, namely:

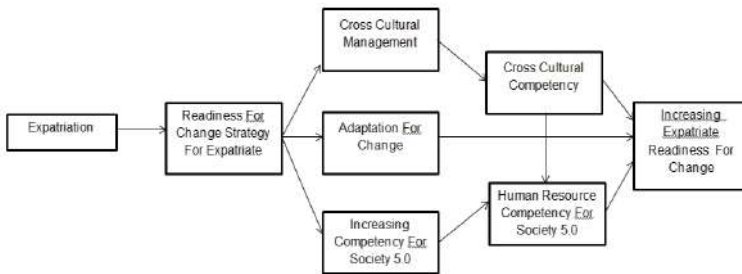
1. Cultural changes that exist in the destination country. This cultural change will cause culture shock, resulting from anxiety and anxiety that comes from the feeling of losing all things known in the origin country.
2. Changes in organizations where expatriates work. It discusses why, when, and how organizations make changes that come from internal organizational factors, such as changes in vision and mission, policy changes, and company strategy. In addition, it also comes from external factors caused by changes in the organizational environment, such as changes in government regulations related to company operations, economic conditions, and competitor actions.
3. Changes from the development of the industrial revolution era, which is currently entering the society 5.0 era. The Industrial Revolution 4.0 has brought various kinds of technological developments to facilitate all activities within the company, which makes employees have to be able to adapt to all the changes caused. In contrast, Society 5.0 promises various kinds of convenience for humans in meeting the needs of life.

With the many factors of change that expatriates must face, the concept of individual readiness for change becomes very important. Personal readiness for change involves an individual's evaluation of the capacity of the individual and the organization to make a successful change, the need for change, and the benefits that organizational members can derive from the change program [4]. Readiness is one of the most critical factors for the success of expatriates in facing the world of work in the destination country [8]. Readiness is a belief, intention, attitude, and behavior that supports change to achieve success [1]. formulate a more comprehensive concept of readiness for change, defined as a comprehensive attitude.

The comprehensive attitude is simultaneously influenced by content (i.e., what is changed), process (i.e., how change is implemented), context (i.e., the circumstances in which the change occurs), and individual (i.e., the characteristics of those who are required to change). The success of expatriates in working abroad is undoubtedly determined by whether or not the individual is ready to face the changes that arise from the expatriation process [1].

**Discussion**

The concept of readiness for change is an essential factor in determining the success of an expatriate in improving their performance while working for companies abroad. Therefore, a comprehensive model is needed to increase the readiness of expatriates to face changes which are in this study focused on cultural changes, including changes that occur in the organization where expatriates work, and changes from the development of the industrial revolution era, which is currently entering the society 5.0 era. Therefore, based on an in-depth literature review combined with empirical facts faced by an expatriate while working abroad, a model for increasing employee readiness to meet changes in the era of society 5.0 is formulated as shown in Figure 3 below:



**Figure 3. Employees Readiness Improvement Model to Face Changes in The Society 5.0 Era: Study On Indonesian Expatriates Abroad Source: Author (2021)**

In the Society 5.0 era that we will soon face, expatriation is a natural thing and is mainly done by multinational companies. The existence of sending human resources at a certain managerial level (usually top-level) to be assigned to subsidiaries or branches spread throughout the world within a certain period [16]. These expatriates will undoubtedly experience many changes that come from the



internal environment, especially from the external environment [3]. In the model of increasing employee readiness in facing changes in the era of society 5.0, a study on Indonesian expatriates abroad, there are strategies for preparedness to meet changes in these expatriates, namely:

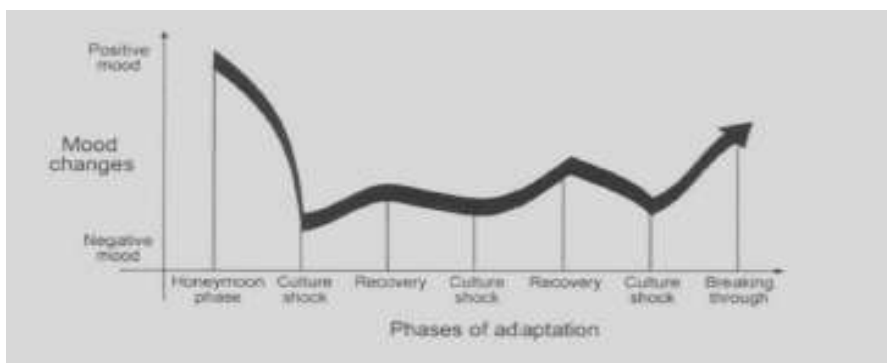
### **Cross Cultural Management**

Cross-Cultural Management in Corporate Culture in the era of globalization is essential for the sustainability of the operational activities of global companies. The different backgrounds of each component in the group will affect the nature and workings of the group [11]. Cross-cultural management can help companies understand how the group environment consists of various backgrounds and can support the performance of elements in the group [6].

One of the programs in cross-cultural management is cross-cultural training. Cross-cultural training can help expatriates adjust to the host country's culture [10]. It can help improve performance, reduce deviant behavior in the workplace, and increase intercultural understanding [14]. In addition, reducing stigmatic and stereotyped thinking, help build cross-cultural teams [12], helps minimize social ambiguity that can cause culture shock, builds cross-cultural competence, and will ultimately help achieve targets. Individuals and companies in the long run.

### **Adaptation to Change**

The adaptation process of expatriates in the destination country is described by Marx (1999) in 4 stages, as presented in Figure 4 below:



**Figure 4 Adaptation Process**  
**Source: Marx (1999)**

Figure 4 describes the adaptation process to achieve success, which is carried out through several stages while in the destination country by an expatriate, which will determine the achievement of performance during the assignment period, and also affect the careers of expatriates after the assignment period is over and returns to their home country. These stages are divided into 4 phases, namely:

1) Honeymoon phase

This phase is characterized by a positive attitude and enthusiasm that expatriates usually show towards their destination country, culture, and new things they encounter [18]. At this stage, they feel like tourists on a trip rather than an expatriate. The feeling of being privileged and a critical person makes this phase the most enjoyable phase, and this phase only lasts a few days to a few weeks from their arrival in the destination country.

2) Cultural Shock Phase

Culture shock results from the anxiety and restlessness that stems from the feeling of losing known and familiar things. Feelings of loss of orientation in daily life include confusion and the inability to make decisions in many situations. Thus, culture shock can cause confusion, anxiety, frustration, frequent emotions, deviant behavior, inability to perform tasks, self-isolation, and depression.

3) Recovery

In this phase, individuals will try to control their emotions and create positive behavior towards people and the surrounding environment. But, again, language skills are critical to helping overcome culture shock.

4) Adjustment

The final phase of the adaptation process is the adjustment phase. At this stage, all the factors that can cause culture shock have been overcome by the expatriates to give their best performance. It is inseparable from the fact that they have begun to be able to accept and adapt to their environment [9]. In addition, they become very accustomed to the country where they work. So that when the assignment period ends and they return to their home country, they will begin to miss the days of being expatriates.

### **Increasing Competence to Face Society 5.0**

Human Resources (HR) must be responsive to change to face global competition and enter the era of Society 5.0. As we know that the Society 5.0 era is an era that is human-centered and technology-

based, so some competencies that human resources, especially expatriates, must possess:

- 1) **Mastery Information System Technology.**  
The information technology system is a technology that can help organizations to manage daily transactions, manage overall business operations, manage managerial activities, and manage strategic activities and help provide information to certain outside parties with the necessary reports to improve work effectiveness and efficiency [15].
- 2) **Mastery International Language.**  
English is indeed a foreign language that must be mastered [17]. However, besides English, several other languages must be learned in the Society 5.0 era, including Arabic, Mandarin, Japanese and French.
- 3) **Mastery Softskill.**  
Soft skills are intrapersonal competencies, namely understanding and controlling oneself [5]. Soft skills to face the Society 5.0 era include the ability to think critically, creativity and innovation, the ability to collaborate, and the ability to communicate effectively

## **Conclusion**

Cross-cultural management, adaptability and competence in facing the Society 5.0 era will help shape cross-cultural competencies and competencies in the Society 5.0 era, so that in the end will increase the readiness of expatriates to face various changes. The model of increasing employee readiness in facing changes in the era of society 5.0 becomes a guide for expatriates and companies to be able to help increase readiness for change which will certainly improve individual performance and company performance. There are three focus strategies that can be implemented including cross-cultural management by organizing cross-cultural training to help improve cross-cultural competence. Furthermore, increasing the ability of expatriates to adapt and increasing competence to face Society 5.0 which will form competency ownership to face the era of society 5.0.

## **References**

- [1] Azra, M. V., Etikariena, A., & Haryoko, F. F. (2019). The effect of job satisfaction in employee's readiness for change. *Diversity in Unity: Perspectives from Psychology and Behavioral Sciences, 2007*, 503–510. <https://doi.org/10.1201/9781315225302-63>
- [2] Barber, V. A. (2010). A Study of Change Readiness: Factors That Influence the Readiness of Frontline Workers Towards a Nursing Home Transformational Change Initiative. *Dissertation, Doctor Of*

- Education St. John Fisher College*, 168.  
<http://libguides.sjfc.edu/citations>.
- [3] Caliskan, S., & Isik, I. (2016). Are you ready for the global change? Multicultural personality and readiness for organizational change. *Journal of Organizational Change Management*, 29(3), 404–423. <https://doi.org/10.1108/JOCM-07-2015-0119>
- [4] Choi, M., & Ruona, W. E. A. (2011). Individual readiness for organizational change and its implications for human resource and organization development. *Human Resource Development Review*, 10(1), 46–73. <https://doi.org/10.1177/1534484310384957>
- [5] Cukier, W., Hodson, J., & Omar, A. (2018). “Soft” Skills are hard a review of the literature. *Journal of Technology and Science Education*, 18(May), 52–61. <https://doi.org/10.1590/0104-530X3038-16>
- [6] Doost Mohammadian, H. (2017). An Overview of International Cross Cultural Management. *University of Applied Sciences (FHM)*, 2–20. [https://www.fh-mittelstand.de/fileadmin/pdf/Publikationen/An\\_Overview\\_of\\_International\\_Cross\\_Cultural\\_Management.pdf](https://www.fh-mittelstand.de/fileadmin/pdf/Publikationen/An_Overview_of_International_Cross_Cultural_Management.pdf)
- [7] Fukuyama, M. (2018). Society 5.0: Aiming for a New Human-centered Society. *Japan SPOTLIGHT*, August, 8–13.
- [8] Helfrich, C. D., Kohn, M. J., Stapleton, A., Allen, C. L., Hammerback, K. E., Chan, K. C. G., Parrish, A. T., Ryan, D. E., Weiner, B. J., Harris, J. R., & Hannon, P. A. (2018). Readiness to change over time: Change commitment and change efficacy in a workplace health-promotion trial. *Frontiers in Public Health*, 6(APR), 1–9. <https://doi.org/10.3389/fpubh.2018.00110>
- [9] Ikeguchi, C. (2008). Cultural Learning and Adaptation: A Closer Look at the Realities. *Intercultural Communication Studies*, 17(1), 285–298.
- [10] Ko, H., & Yang, M. (2011). The effects of cross-cultural training on expatriate assignments. *Intercultural Communication Studies*, 1, 158–174. <http://www.uri.edu/iaics/content/2011v20n1/12Hsiu-ChingKoMu-LiYang.pdf>
- [11] Mihaela, H. (2014). A synergistic approach of cross-cultural management and leadership style. *Journal of International Studies*, 7(2), 106–115. <https://doi.org/10.14254/2071-8330.2014/7-2/9>
- [12] Reiche, B. S., Lee, Y., & Quintanilla, J. (2020). Cross-cultural training and support practices of international assignees. *The Routledge Companion to International Human Resource*

- Management*, August 2013, 334–349.  
<https://doi.org/10.4324/9781315761282-29>
- [13] Rimayanti. (2019). DAMPAK REPATRIASI BAGI PARA EKSPATRIAT NEGARA. *Journal of Islamic and Law Studies*, 3(1), 63–84.  
<http://jurnal.uin-antasari.ac.id/index.php/jils/article/view/2717%0A63%0ADA>  
 MPAK
- [14] Robert Bean. (2008). Cross-cultural training and workplace performance: Support document. *National Centre for Vocational Education Research (NCVER)*.
- [15] Schmid Mast, M., Kleinlogel, E. P., Tur, B., & Bachmann, M. (2018). The future of interpersonal skills development: Immersive virtual reality training with virtual humans. *Human Resource Development Quarterly*, 29(2), 125–141.  
<https://doi.org/10.1002/hrdq.21307>
- [16] Siregar, R. A., & Perdhana, M. S. (2018). Tahapan penyesuaian lintas budaya pada ekspatriat di kota semarang. *Diponegoro Journal Of Management*, 7, 1–6.
- [17] Vodopija-Krstanović, I., & Marinac, M. (2019). English as an international language and English language teaching: The theory vs. practice divide. *Iranian Journal of Language Teaching Research*, 7(2), 19–38.
- [18] Winkelman, M. (1994). Cultural Shock and Adaptation. *Journal of Counseling & Development*, 73(2), 121–126.  
<https://doi.org/10.1002/j.1556-6676.1994.tb01723.x>

# Features of Collaborative Writing in EFL Context

Ani Susanti<sup>10</sup>

## Introduction

Collaboration is one of the most important skills to have in the twenty-first century, especially in the context of Society 5.0. According to sociocultural theory, learning is a socially constructed process in which learners' cognitive changes or new understanding are mediated by interaction with one another; knowledge is negotiated during pair work through the use of scaffolding [1], [2]. Consequently, when learners participate in a foreign language activity in a group setting, they work together to solve their language problems. The most common kind of collaboration in an EFL context is collaborative writing.

Collaborative writing is the process through which two or more writers collaborate to create or co-author a piece of written work [3], [4]. Collaborative writing can occur in various settings because the writers engage in the overall writing process or aspects of it, such as group planning or peer editing; collaborative writing places a strong emphasis on the concept of collective accountability. Numerous studies have demonstrated the effectiveness of collaborative writing in improving writing skills, particularly when compared to individual writing [5], [6].

It has been shown that the quality of collaborative writing is significantly dependent on the equality and mutuality of the participants [7]. Verbalization [8] is the term used to describe the process of interaction between peers, which was previously referred to as languaging and collaborative discourse [9]. Speakers solve problems and enhance their knowledge throughout the verbalization process [8], [10] which can be regarded as a dialogue. Verbalization is a process in which learners collaborate to solve language problems and/or develop verbal or linguistic information in the context of L2 learners' interactions [11].

In the next part, the writer will explain the characteristics of collaborative writing and then demonstrate them with examples drawn from the writer's research in a private institution in Indonesia. The information was gathered as part of a more extensive study that looked into the dynamics of collaborative activities in a university-level English as a foreign language essay writing course.

---

<sup>10</sup> Universitas Ahmad Dahlan

The samples in the following section come from audiotape recordings of pair collaborative study sessions that were recorded. All of the examples were taken from a collaborative writing project in which students were paired and asked to produce an essay on the topic of how to be a good parent.

## **Discussion**

Cooperative writing is characterized by four central features: mutuality, equality, scaffolding episodes, and the utilization of collaborative tools. These characteristics distinguish any effective collaborative writing activity, whether it is conducted face-to-face or synchronously.

## **Mutuality**

The primary characteristic that distinguishes collaborative writing from other writing styles is the interpersonal connection between the participants. A higher level of member participation is essential for the success of a joint mutual effort [7]. While participating in the interaction, students will have multiple opportunities to generate and contest ideas, encouraging introspective and creative thinking [12]. Also included is the opportunity for students to engage in conversation with one another on the writing process and the topic [9]; this aids students refine their grasp of the task assigned to them.

Mutual engagement is essential for forming cohesive communities of practice [13]. Members of the activity community feel more connected to one another due to their interactions with one another. Furthermore, the involvement stimulates each individual to provide 'complementary' contributions, which is a valuable asset [14]. Nonetheless, situations that necessitate constant human contact are likely filled with stress and conflict. Before beginning a collaborative writing assignment, teachers may emphasize the necessity of students preparing, coming up with ideas, proposing alternatives, and responding to the points of view of other participants. Additionally, students should develop the ability to listen so that they can be exposed to a range of points of view and thought patterns, in addition to providing their thoughts.

### **Example 1. Mutual Interaction**

A: *oh right*, parents, has... eh parents *means* have. Their own way- their... own way to... educate children,

B: Educated? Using -ed?

A: *No, just* educate.

B: Educate.

Final Text: ....and every parent have their way to educate children.

*A = Siska, B = Cinta*

### **Example 2. Mutual Interaction**

B: *look at the framework.* We will mention

A: *do not use* mention; use explain

B: *Oh, just use this* talking about. We want to talk about

A: *Here, we want to talk about explaining and talking the same?*

B: *Yes talking about*

A: how about discuss

B: Here, we want to discuss the kind of

A: Good parents and step to be a good parent

Final Text :

Here we want to discuss the kind of parents and step to be a good parent.

*A = Wati, B = Jamil*

Example 1 shows mutual interaction between Siska and Cinta, who were discussing the use of 'has' or 'have' after the word 'parents.' Then they realized that 'parents' should be followed by 'have.' After that, Cinta doubted if they should put '-ed' after the word 'educate' or not. Siska briefly answered that they should not use '-ed.' Then, the final sentence became '....and every parent have their way to educate children.'. While in example 2, Wati and Jamil were talking about word choices. They were discussing if they should use the word 'mention' or 'explain.' Then Jamil argued about using 'talking,' but Wati thought that using 'discuss' was better. Finally, they came up with the sentence 'Here we want to discuss kind of parents and step to be a good parent.'.

### **Equality**

Another characteristic of collaborative writing that distinguishes it from other forms of writing is the exchange of knowledge [15], [16]. Students differ from one another in various ways, including their level of language competence, skill, and prior experiences. When students collaborate, they bring their own unique set of skills to the group's table. A person could have a wide range of knowledge and competence in various disciplines. Those who are unable to write effectively, for example, can submit good thoughts or examples of what they have learned. Some people excel at sentence construction, arrangement, grammar, and writing techniques, while others struggle with these skills. Others may have been more



concerned with the objective and perception of the audience, with evaluation, or even with time management.

Combining each team member's strengths raises the likelihood that the learner's Zone Proximal Development (ZPD) will be raised, resulting in a higher-quality essay for the learner to submit [17]. The involvement of writers with a variety of writing styles and tactics and a mutual exchange of ideas and experience could result in a significantly more accurate and more decadent piece of writing. The pooling of diverse abilities enables students to collaborate on knowledge production and enhance their writing abilities to a greater extent than they would be able to do individually.

The students should be reminded that, while sharing knowledge is beneficial to all, they should be willing to share information and talents to make the learning processes more worthwhile and fruitful for themselves and others.

### **Example 3. Equal Contribution**

A: it means the title will not be related

B: yes, cause how to be, means it is more similar to procedure text. If not, make it the second paragraph. The introduction is about a good parent. Then the steps are in the second paragraph.

A: if not like this, the intro, then the second paragraph, the steps

B: all right, the second is the kinds, the third is the step, then the conclusion.

Back here. The first is parents introduction, yes

*A = Sheila, B = Lila*

### **Example 4. Equal Contribution**

A: *how to combine love and discipline. It is through the way, for example, by giving the reward. Giving a reward is a must. Must it be a gift? No right?*

B: *praise can be too*

A: *once in a while you have to give the gift*

B: *ok, but do not overdo it. They will be spoiled*

A: *but besides... ooh what if the rewards being like this, what's that what's the name, like something have to do later, in the end, they'll give a reward. It means the conclusion done, the outline done, And now the essay. Just write the essay.*

*A = Zarin, B = Icha*

In Example 3, Sheila and Lila were discussing the part of paragraphs. They talked about what should be in the introduction part and in which paragraph they should put 'kind,' 'step' and 'conclusion'

of the topic. Sheila and Lila both shared their understanding of how to organize an essay in a logical manner, which was really appreciated. In Example 4, Zarin and Icha were talking about the topic. They were discussing if parents should give their children awards or not. They finally made the conclusion and outlined then began to write the essay. Zarin and Icha shared their knowledge about being good parents and complement one another.

### **Scaffolding Episodes**

A collaborative group's capacity to function smoothly depends on the presence of certain advantageous emotional traits, such as trust, dependability, commitment, and respect for the group members [18]. Learners are more willing to collaborate and communicate actively when they are not afraid of being ridiculed. The ability to debate opposing perspectives without fear is enhanced when students feel comfortable communicating in a friendly learning environment [19]. In developing pleasant feelings for one another, it becomes easier for collaborators to establish an intersubjectivity agreement on the subject matter at hand and agree calmly to continue working on different issues together.

In addition, the emotions and motives of learners might impact their learning. Reduced productivity, a dislike or fear of writing, and other manifestations of anxiety brought on by language learning demands are all possible outcomes. The need for an environment of preparedness and willingness to serve, in which students may rely on one another's strengths to make up for their failings, is vital to the school's success. Aside from fostering conducive and productive environments for cooperation, teachers must be on the lookout for any potential fissures in-group cohesion. In order to support learners throughout the partnership, neither didactic attitudes nor judgemental actions must be taken. When a group becomes dysfunctional due to unresolved affective conflict, teachers must intervene by interacting with refractory group members or, if required, by changing the composition of the group members. It is critical to emphasize the value of mutual respect, tolerance, and engagement among group members in every cooperative project and the importance of individual respect and tolerance [8]. Examples 1 to 6 demonstrate how the instance pair demonstrated commitment, teamwork, and mutuality in their interactions. In terms of collectivism, they demonstrated a high level of willingness to participate in knowledge construction and the growth of their writing abilities.

### **Example 5. Scaffolding through Elicitation**

A: The reason?

B: Give them the reason why they are

*Just like that. What else <5>*

A: The excellent parent should help. *The earlier one*

B: *which one*

A: To help their children solve their bad behavior without yelling at them or punishment. [Punishment is kind of make traumatic] Without making a traumatic. Impact or feeling for them

*A = Della, B Nisa*

### **Example 6. Scaffolding through Repetition**

A: *how about (in your opinion) which better, strict parents or relaxed parents,*

B: *which,*

A: *whether,*

B: *whether? Eh, wait, wait, which is better, whether the strict or...*

A: *Relaxed parents,...*

B: *between, right?*

A: *is it between?*

B: *is it whether or between yeah between*

*A = Nada, B = Hedi*

In Example 5, Della-Nisa was developing the paragraphs. They were making a sentence step by step by eliciting a response with a question from each other. In Example 6, Nada and Hedi kept repeating the exact words. They often mentioned 'which,' 'whether,' and 'between.' A significant sense of group responsibility is seen in the pairs' elicitation and repetition during the task completion process.

### **Tools for Collaboration**

In face-to-face collaborative writing, students can use paper and a pen to handwrite together, or they can use a computer or a laptop to write in turns, or they can use more complex tools such as a word processor or synchronous collaborative writing platform. With the advent of technology, society 5.0 has begun to take shape, helping people deal with their daily lives more successfully, including collaborative writing projects. Blog [11], Wiki [20], Google Doc [21], [22], Viber [23], Etherpad [24] and Blackboard [25] are just a few of the collaborative writing tools that have been developed and have proven to be beneficial in the classroom. With the help of these technologies, users can collaborate in real-time.

## Conclusion

By collaborating on writing assignments, students can increase their sense of freedom while also creating a learning society, encouraging reliance, and establishing an environment for learning in a social setting. Students learn how to write from their peers, exchange knowledge, and make decisions as a collective. According to the research findings, as a result of their cooperation and collaboration, they learn how to resolve disagreements and conflicts, employ strategies, and ensure that collaboration is a positive experience for all participants. A group's ability to work together effectively is determined not just by the individuals' language abilities but also by their motivation and attitudes for seeing the group through to completion. The article suggests that students should be prepared for collaboration by developing basic guidelines for collaboration or even designing the collaborative effort to demonstrate how they can meaningfully co-construct knowledge in a group setting while also gaining experience in collaboration.

## References

- [1] R. Donato, "Collective Scaffolding in Second Language Learning," in *Vygotskian approaches to second language research*, J. P. Lantolf and G. Appel, Eds. Norwood, New Jersey: Ablex Pub, 1994, pp. 33–56.
- [2] L. S. Vygotsky, *Mind in Society: The Development of Higher Psychological Processes*. London, England: Harvard University Press, 1978.
- [3] N. Storch, "Collaborative writing: Product , process , and students ' reflections," *J. Second Lang. Writ.*, vol. 14, no. 3, pp. 153–173, 2005, doi: 10.1016/j.jslw.2005.05.002.
- [4] N. Storch, "Collaborative Writing," in *The TESOL Encyclopedia of English Language Teaching*, 1st ed., John I. Liantas, Ed. John Wiley & Sons, Inc., 2018.
- [5] M. Khatib and H. Meihami, "Languaging and Writing Skill: The Effect of Collaborative Writing on EFL Students' Writing Performance," *Adv. Lang. Lit. Stud.*, 2015, doi: 10.7575/aiac.all.v.6n.1p.203.
- [6] A. Shehadeh, "Effects and student perceptions of collaborative writing in L2," *J. Second Lang. Writ.*, vol. 20, no. 4, pp. 286–305, 2011, doi: 10.1016/j.jslw.2011.05.010.
- [7] N. Storch, "Collaborative writing in L2 contexts: Processes, outcomes, and future directions," *Annu. Rev. Appl. Linguist.*, vol. 31, pp. 275–288, 2011, doi: 10.1017/S0267190511000079.
- [8] Y. Watanabe, "Collaborative and Independent Writing: Japanese

- University English Learners' Processes, Texts and Opinions," Unpublished Doctoral Dissertation, University of Toronto, 2014.
- [9] M. R. Lassiter, "Collaborative and Genre-Based Writing in the L2 Writing Classroom," 2014.
- [10] M. Swain and Y. Watanabe, "Languaging: Collaborative Dialogue as a Source of Second Language Learning," *The Encyclopedia of Applied Linguistics*. Blackwell Publishing Ltd., 2012, doi: 10.1002/9781405198431.wbeal0664.
- [11] Z. Amir, K. Ismail, and S. Hussin, "Blogs in language learning: Maximizing students' collaborative writing," vol. 18, pp. 537–543, 2011, doi: 10.1016/j.sbspro.2011.05.079.
- [12] A. F. Dabao, "Collaborative writing tasks in the L2 classroom: Comparing group, pair, and individual work," *J. Second Lang. Writ.*, vol. 21, no. 1, pp. 40–58, 2012, doi: 10.1016/j.jslw.2011.12.002.
- [13] M. Li and W. Zhu, "Explaining dynamic interactions in wiki-based collaborative writing," *Lang. Learn. Technol.*, 2017.
- [14] M. Li and D. Kim, "One wiki, two groups: Dynamic interactions across ESL collaborative writing tasks," *J. Second Lang. Writ.*, vol. 31, 2016, doi: 10.1016/j.jslw.2016.01.002.
- [15] C. Lai, C. Lei, and Y. Liu, "The nature of collaboration and perceived learning in wiki-based collaborative writing," *Australas. J. Educ. Technol.*, vol. 32, no. 3, pp. 80–95, 2016, doi: 10.14742/ajet.2586.
- [16] Y. M. Fung, "Collaborative writing features," *RELC J.*, vol. 41, no. 1, pp. 18–30, 2010, doi: 10.1177/0033688210362610.
- [17] A. Mirzaei and Z. R. Eslami, "ZPD-activated languaging and collaborative L2 writing," *Educ. Psychol.*, vol. 35, no. 1, 2015, doi: 10.1080/01443410.2013.814198.
- [18] A. Susanti, U. Widiati, and B. Y. Cahyono, "The effect of proficiency pairings on EFL students' writing ability in genre-based approach context," *Int. J. Eval. Res. Educ.*, vol. 9, no. 1, pp. 245–251, 2020, doi: 10.11591/ijere.v9i1.20439.
- [19] M. Zhang, "Collaborative writing in the EFL classroom: The effects of L1 and L2 use," *System*, 2018, doi: 10.1016/j.system.2018.04.009.
- [20] Z. Aydın and S. Yildiz, "Use of wikis to promote collaborative EFL writing," *Lang. Learn. Technol.*, vol. 18, no. 1, pp. 160–180, 2014, doi: <http://dx.doi.org/10125/44359>.
- [21] D. Bikowski and R. Vithange, "Effects of web-based collaborative writing on individual L2 writing development," *Lang. Learn. Technol.*, vol. 20, no. 1, pp. 79–99, 2016, doi: <http://dx.doi.org/10125/44447>.

- [22] Z. I. Abrams, "Collaborative writing and text quality in Google Docs," *Lang. Learn. Technol.*, vol. 23, no. 2, 2019.
- [23] I. Challob, N. A. Bakar, and H. Latif, "Collaborative Blended Learning Writing Environment : Effects on EFL Students' Writing Apprehension and Writing Performance," vol. 9, no. 6, pp. 229–241, 2016, doi: 10.5539/elt.v9n6p229.
- [24] C. Brodahl and N. K. Hansen, "Education Students' Use of Collaborative Writing Tools in Collectively Reflective Essay Papers.," *J. Inf. Technol. Educ.*, vol. 13, pp. 91–120, 2014, [Online]. Available:  
<http://ezproxy.georgetowncollege.edu:2048/login?URL=http://search.ebscohost.com/login.aspx?direct=true&db=a9h&AN=112355395>.
- [25] J. Choi, "Online Peer Discourse in a Writing Classroom," vol. 26, no. 2, pp. 217–231, 2014.

# **The Hoax as Terror Communication: Threats and Challenges in Society 5.0**

Ari Sulistyanto, Hamida Syari Harahap, Wichitra Yasya

## **Introduction**

Hoaxes are deceptive warning messages designed to undermine public trust in an organization, product, service or, person.[1] But in its development, the hoax has also become a terror that is deliberately designed to spread fear and anxiety. This article discusses the challenges and threats of hoaxes as terror communication in Society 5.0, and also discusses preventive measures, both repressively through the application of positive law and socialization with education through increasing digital media literacy skills.

In many cases, hoaxes can have an impact on community instability and disharmony. For example, the riots that occurred in Wamena Papua in September 2019. Racist remarks that were instigated in Wamena Papua, caused the people to be provoked ending in riots which resulted in 23 deaths, not including the injured. [2] Likewise, during the Covid 19 pandemic, the hoax on Covid-19 vaccines stating that those who are vaccinated die within 3 years caused people to refuse vaccinations, thus resulting in mortalities when they contract the Covid-19 virus [3]. Another fact is that when people with disabilities in Yogyakarta took action against vaccines due to believing hoaxes about the impact that would arise after the vaccine. [4] During the pandemic, hoaxes on vaccines spread and develop at a rapid rate [5].

These facts at least explain that a hoax is the dissemination of certain manipulative information, which does not contain the truth, and also lies, with the aim of influencing attitudes and influencing the behavior of the target audience to engage in certain actions. [6] Hoaxes are typically associated with individuals or groups who are secretly planning to achieve certain goals. [7] Therefore, hoaxes become a strategy to maximize public attention, because those who are exposed to hoaxes oversimplify problems and process information at a glance so that they make decisions heuristically.[8] Hoax is an antagonism that spreads messages that are intentionally designed to scare recipients into complying by threatening them with negative consequences for non-compliance. This kind of practice is akin to making hoaxes a form of terror communication.

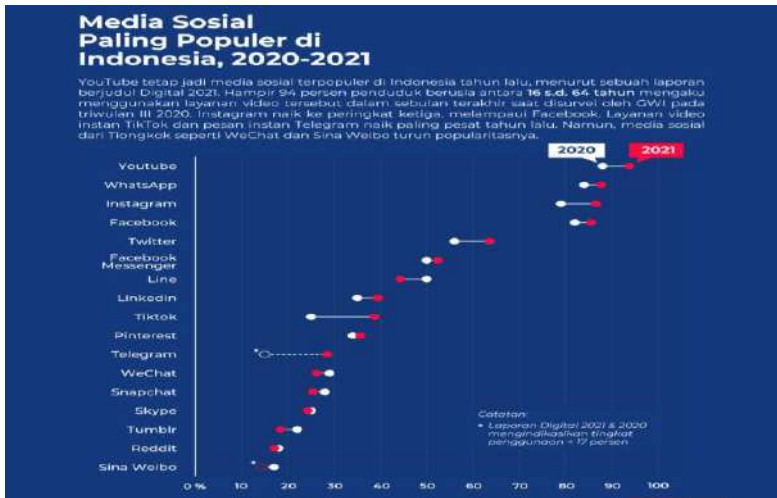
Society 5.0 positions humans at the center of technological modification and innovation for the benefit of humanity [9]. This is characterized by the integration of physical and virtual spaces based on big data technology collected by the Internet of things (IoT) [10]. The characteristics of Society 5.0 have a positive impact on the use of advanced technologies such as IT, IoT, robotics, artificial intelligence, and augmented reality in human life, health, and other fields, while Industry 4.0 limits technological progress only in the industrial sector [9]. Other characteristics are that it has an impact on traffic of information that are now moving and spreading faster. The term, with one "touch" on communication technology equipment, such as gadgets. Information moves in seconds to reach an unlimited audience. This condition becomes a fertile field for the spread of hoaxes.

One effort to countermeasure hoaxes is digital media literacy, initially understood as skills in reading with critical thinking. [11] In its development, it is defined as a dynamic training practice that not only counters negative messages but also empowers everyone to engage with the media as an active citizen [12]. The problem is, in this Society 5.0, based on the results of a survey conducted by the Program for International Student Assessment (PISA) released in 2019, Indonesia's literacy rate is ranked 62 out of 70 countries, or in the bottom 10 countries with lowest literacy levels. [13] With regard to hoaxes, the low level of digital media literacy in Indonesia is a challenge and threat in Society 5.0.

## **Discussion**

The total population of Indonesia is currently around 271.34 million.[14] Based on Reportal Data until January 2021, Indonesia has 202.6 million internet users. This number increased by 27 million or 16% compared to the previous year. Meanwhile, internet penetration reached 73.7%. YouTube is still the most popular social media in the country. In the second place, WhatsApp was followed by Instagram in the third position. Instagram rose to third place because it succeeded in displacing Facebook to fourth position. The short video application TikTok and the messaging medium Telegram showed the most rapid increase in 2020. Meanwhile, social media from China such as WeChat or Sina Weibo are decreasing in popularity in the country. [15] Regarding the percentage of social media use, it can be seen in Figure 1.





**Figure 1: Rank of Social Media Use**  
Source : Digital 2021, Digital 2020, GWI

Throughout January 23, 2020 to July 18, 2021, 1,763 hoaxes on Covid-19 issues have been found which have spread to 3,817 social media posts, of which 3,356 posts have been taken down. These findings were followed up by law enforcement by the Indonesian National Police on 767 cases until July 15, 2021. [16] Throughout October 4, 2020 to July 18, 2021, 252 hoaxes on Covid-19 vaccine issues have been found in 1,850 social media posts, all of which have been handled or taken down. These hoaxes were regarding issues such as: 1) vaccines cause electromagnetic radiation waves, 2) misinformation alleging that vaccines cause death, and also 3) misinformation stating that the spread of the Delta variant of Covid-19 was caused by vaccination. [16]



**Figure 2. Hoax information on opening of a church in Mecca** Source: Kominfo



**Figure 3. Hoax information on Chinese Non-Muslims engage in salat (Muslim prayer)** Source: Kominfo

Regarding the motive, based on the police investigation of the perpetrators of hoax spreaders, as revealed by the Head of the Public Relations Division of the National Police, Brigadier General (Pol) Argo Yuwono said, some of the motives of the perpetrators were, among others, for fun and due to feeling dissatisfied with the government [17]. Meanwhile, hoax content is quite diverse, ranging from trivial to political issues, such as attacking certain figures or spreading hatred against the government. The spread of hoaxes has also become an arena for religious-based contestation. For example, social media platforms such as YouTube and Facebook show a number of people running and attending prayers in the streets. Several video narrations claim that Chinese citizens (non-Muslims) attend the prayer for fear of contracting the Coronavirus.[18] On the other hand, a hoax appeared, in a post on social media with the narration "Praise God after the Covid-19 Virus. Many Muslims in Arabia have apostatized", the post is accompanied by a video with the title "Masha Allah opening of a church in Mecca". [18]

### **The Hoax as Terror Communication**

The narratives presented in the hoax are full of manipulation, intimidation and provocation resulting in fear and anxiety. This communication model is the same as the practice of terrorism. The term terror is a new understanding because of the social impetus for the rise of the phenomenon of terrorism. [19] The terror communication approach (CT) describes terrorist acts as communication events. Namely, acts of terrorism bring up persuasive meanings and symbols to the audience that give rise to fear and anxiety. [20] For example, the case of a suicide bombing in front of the Makassar Cathedral Church and the attack on the National Police Headquarters. These acts of terror create rhetorical actions, such as labels, symbols, and definitions. [21] Every act of terror gives a label of damage and loss of life. While symbols state that acts of terror are a form of violence. Thus, as defined, terror is an act carried out with violence and destruction and requires sacrifice to achieve the goal. In an act of terror there are 2 things to be communicated, namely mediatization and ritualization. Mediatization refers to coercive efforts for media coverage of acts of terror, while ritualization is the will to demonstrate the sacred or holy purpose of the act. [6]

Likewise, the spread of hoaxes is a communication event. This is related to the elements of "*Who, says what, through which channel, to whom, with what effect*". In hoaxes, it is certain that there are actors behind the spread as planners who produce hoaxes with a specific purpose and expect an influence from the spread of the hoax. Through

manipulative messages that are designed in such a way with labels, symbols and definitions by forming meaning in binary oppositions: one side is described as positive, while the other side is described as negative. For example, the hoaxes in Figures 2 and 3 explain the contestation of religious beliefs between Islam and Christianity. In Figure 2, Christianity has been accepted in Saudi Arabia which is a Muslim country. This hoax gives meaning, Christianity as positive, while Islam as negative. Likewise, the hoax in Figure 3, Islam as positive and China as a Communist country is labeled as negative.

Society 5.0 guarantees the freedom to use social media platforms and gives everyone the opportunity to produce and spread messages. The manipulative characteristics of hoaxes with message content that always propagate hatred and division will cause fear and anxiety. This kind of practice makes hoaxes a form of terror communication and becomes a threat to Society 5.0.

### **Legal Action**

Society 5.0 is an information society built on society 4.0, aiming to create a prosperous, human-centered society that is integrated in a virtual space. [22] This fact makes fake news or hoaxes a real threat that disrupts the sustainability of the community in Society 5.0. There are several actions taken by the government and non-government institutions in preventing the spread of hoaxes. The government agencies that carry out the anti-hoax movement are the Ministry of Communication and Information (Kominfo), the Coordinating Ministry for Political, Legal and Security Affairs (Menkopolkam), the National Counterterrorism Agency (BNPT), the Indonesian National Police (Polri), and the Indonesian Press Council, while non-government institutions, such as Line, Turn Back Hoax, Hoax Analyzer, and AppsMu. [23]

One of the actions taken by BNPT, through the Ministry of Communication and Information (Kominfo), is to block 22 Islamic online media sites, because they have spread and provoked people with radical teachings. [24] They block these sites because in the news they spread and support radical teachings, such as using violence in the name of religion, takfiri or judging other people as infidels, also supporting, spreading, and inviting to join ISIS, and interpreting jihad in a limited way. [25] Online media websites based on internet communication technology give wider opportunities to spread spread the ideology of radicalism and terrorism. This is due to its fast, good and inexpensive characteristics, making it easy to spread widely and quickly. [26].

From a legal perspective, those who spread false information or hoaxes in cyberspace will be subjected to positive laws, such as violations of the Criminal Code (KUHO), Law No. 11 Year 2008 concerning Information and Electronic Transactions (ITE), Law No. 40 Year 2008 concerning Elimination of Racial and Ethnic Discrimination, as well as actions when hate speech has caused social conflict, hoax spreaders in cyberspace can also be subjected to hate speech which has been regulated in the Criminal Code and other laws outside the Criminal Code. [26]

### **Digital Skills**

Repressive measures in the form of sentencing for hoax spreaders are important. However, preventive efforts are also needed because it involves the human aspect as a producer and consumer of information, namely through socialization and education about digital media literacy. Describes digital literacy as the ability to understand and apply various forms of information science from multiple sources to present information on a computer. [27] This definition develops to view digital literacy as realization of individuals, attitude and capacity to use digital tools to access, manage, integrate, analyze and synthesize digital information sources by generating new knowledge while also producing various forms of digital media content to communicate in everyday life. [28] This definition includes three dimensions of digital literacy, namely technical, cognitive and sociological skills.

Digital media literacy skills are needed in dealing with hoaxes in Society 5.0. Digital literacy involves more than just the ability to operate digital devices, but also a variety of cognitive, motor, sociological, and emotional skills that function effectively in dealing with a digital environment. In a study on secondary school children in Thailand, it was revealed that developing digital literacy on specific information, such as hoaxes, requires skills, in this case, information management skills in the use of digital tools, creation of new content, and information consolidation. [28] More specifically, classified skills in digital literacy. First, photo-visual literacy involves the ability to read visual representations (integrated images, words, sounds) of digital text. Second, reproductive literacy involves the ability to create new information through the integration of fragments of various types of digital texts. Third, branching literacy; relating to the ability to efficiently navigate through the nonlinear text. Fourth, information literacy involves the ability to critically evaluate digital information. Fifth, emotional social literacy, which involves the ability to communicate effectively with others using digital media. The six are

referred to as all-time thinking skills; involving the ability to process and evaluate high-level digital information through, for example, digital games or online chat room experience.

In regards to preventing hoaxes in Indonesia, thus it is needed to develop digital media literacy skills in the country. Explains that the process of developing digital media literacy skills for young Indonesians needs to involve many stakeholders in proactive extensive collaboration with policy makers. Regional and National (central government) policy makers as well as various communities need to work together to encourage national curriculum policies, and encourage digital media literacy as a sustainable national program. [11] Based on these findings, it is necessary to teach digital media skills as a mandatory curriculum in schools from an early age (Kindergarten) to senior high school (SMTA). Introduction from an early age is important, because the ability to absorb digital media literacy skills, for those at a younger age will receive better skills than older ones. [29]

## **Conclusion**

Hoax as false information becomes a part of terror communication because the message content includes labeling, symbolizing and defining the actual facts, resulting in fear and anxiety. Society 5.0 is a characteristic of the integration of physical and virtual spaces based on digital media, in which hoaxes become a new terror threat. Therefore, countermeasures and prevention are carried out through the application of positive law and digital media skills education as a mandatory curriculum for children from early childhood to senior high school levels in a systematic and continuous manner.

## **References**

- [1] T. Sellnow, A. Parrish, and L. Semenas, "From Hoax as Crisis to Crisis as Hoax: Fake News and Information Disorder as Disruptions to the Discourse of Renewal," *J. Int. Cris. Risk Commun. Res.*, vol. 2, no. 1, pp. 121-142, 2019, doi: 10.30658/jicrcr.2.1.6.
- [2] Josina, "Kabar Hoax Timbulkan Korban Jiwa, Apa Solusinya?," *Detik.Com*, 2019. .
- [3] J. L. Ravelo, "Hoaks Membunuh Ayahku: Menyingkap pandemi lain di Indonesia," *Unicef.org*, 2021. .
- [4] A. Septiawan and H. Harlan, "Banyak Penyandang Disabilitas yang Jadi Korban Hoax Vaksin Covid-19," *Detik.Com*, 2021. .
- [5] Fisher, B. K., W. B., S. J., Crawford, and H. Fouayzi, "Attitudes

- toward a potential SARS-CoV-2 vaccine: A survey of U.S. adults," *Ann. Intern. Med.*, vol. M20, no. 3569, p. In Press, 2021, doi: 10.7326/M20-3569.
- [6] C. Pellerin, "Communicating Terror: An Analysis of ISIS Communication Strategy," *Kuwait Progr. Sci. Po*, p. 18, 2016.
- [7] K. Park and H. Rim, "Social media hoaxes, political ideology, and the role of issue confidence," *Telemat. Informatics*, vol. 36, pp. 1–11, 2019, doi: <https://doi.org/10.1016/j.tele.2018.11.001>.
- [8] van der Linden, "What a hoax: Why people believe in conspiracy theories," *Sci. Am. Mind*, vol. 24, no. 4, pp. 41–43., 2015.
- [9] A. G. Pereira, T. M. Lima, and F. Charrua-santos, "Industry 4.0 and Society 5.0: Opportunities and Threats," *Int. J. Recent Technol. Eng.*, vol. 8, no. 5, pp. 3305–3308, 2020, doi: 10.35940/ijrte.d8764.018520.
- [10] P. Skobelev and Y. S. Borovik, "On The Way From Industri 4.0 To Industri 5.0: From Digital Manufactureing To Digital Society.," *Int. Sci. Res. J.*, vol. 2, no. 6, pp. 307-311., 2021.
- [11] F. Suwana, "Content, changers, community and collaboration: expanding digital media literacy initiatives," *Media Pract. Educ.*, vol. 0, no. 0, pp. 1–18, 2021, doi: 10.1080/25741136.2021.1888192.
- [12] R. Hobbs, *Create to Learn: Introduction to Digital Literacy*. Hoboken, NJ: John Wiley & Sons., 2017.
- [13] L. D. Utami, "ingkat Literasi Indonesia di Dunia Rendah, Ranking 62 Dari 70 Negara," *Tribunews.com*, 2021. .
- [14] M. Idris, "Jumlah Penduduk Indonesia Terkini Mencapai 271,34 Juta," *Kompas.Com*, 2021. .
- [15] Y. Dahono, "Data: Ini Media Sosial Paling Populer di Indonesia 2020-2021," *Beritasatu.com*, 2021. .
- [16] J. B. K. Kominfo, "Menkominfo Menyesalkan Maraknya Infodemi di Masyarakat dan Menginstruksikan Semua Platform Media Sosial untuk Sigap Mencegah Penyebarannya," *Kominfo .go.id*, 2021. .
- [17] D. Halim, "Iseng dan Tak Puas dengan Pemerintah, Motif Pelaku Sebar Hoaks Terkait Virus Corona," *Kompas.Com*, 2020. .
- [18] Kominfo, "Laporan Hoak Kominfo," *Kominfo .go.id*, 2020. .
- [19] D. Miller and T. Mills, "Producing and communicating terror expertise," no. September 2001, pp. 1–29, 2010.
- [20] E. Olsson, M. Söderlund, and J. Falkheimer, "Communicating Terror: Selecting, Reinforcing and Matching Frames in Connection to the Attacks in Norway on July 22, 2011," *Scand. J. Public Adm.*, vol. 19, no. 1, pp. 3–22, 2015.
- [21] J. S. Tuman, *Communicating Terror: The Rhetorical Dimensions of*

- Terrorism*. San Francisco State University: SAGE Publications Ltd, 2010.
- [22] Fukuyama. Mayumi, "Society 5.0: Aiming for a New Human-centered Society," *Japan SPOTLIGHT*, no. August, pp. 8–13, 2018.
- [23] M. Nurlatifah, "The Fight Against Hoax: An Explorative Study towards Anti\_Hoax Movements in Indonesia," *J. Komun. Ikat. Sarj. Komun. Indones.*, vol. 4, no. 1, 2019, doi: 10.25008/jkiski.v4i1.227.
- [24] Kominfo, "BNPT Minta Kominfo Blokir 22 Situs Radikal," *Kominfo.go.id*, 2015. .
- [25] A. Adzkia and S. Indra, "Kriteria Situs Islam Radikal Versi BNPT," *CNN Indonesia*, 2015. .
- [26] Viva.co.id, "Penebar Hoax Bisa Dijerat Segudang Pasal," *Viva.co.id*, 2017. .
- [27] S. Kaeophanuek, N.-S. Jaitip, and P. Nilsook, "How to Enhance Digital Literacy Skills among Information Sciences Students," *Int. J. Inf. Educ. Technol.*, vol. 8, no. 4, pp. 292–297, 2018, doi: 10.18178/ijiet.2018.8.4.1050.
- [28] Y. Eshet-Alkalai, ""Digital literacy: A conceptual framework for survival skills in the digital era," *J. Educ. Multimed. Hypermedia*, vol. 13, pp. 93–106, 2004.
- [29] Y. Eshet-Alkali and Y. Amichai-Hamburger, "Experiments in digital literacy," *Cyberpsychology Behav.*, vol. 7, no. 4, pp. 421–429, 2004, doi: 10.1089/cpb.2004.7.421.

# Implementation of Human Resources in Sharia Capital Market Study Group During Covid-19

Asri Jaya<sup>11</sup>, A.Ifayani Haanurat<sup>12</sup>, Nurlina<sup>13</sup>, Nur'aeni<sup>14</sup>

## Introduction

History shows that the most decisive factor for the success of a country is not its natural wealth, but its human resources. Successes such as Japan, Singapore, Taiwan, and Hong Kong reflect this evidence. The policies of these countries are basically to develop superior quality human resources who can master various fields of Science and Technology as well as professional skills and expertise needed to spur increased added value in various industrial sectors and can create sustainable economic growth.

Development is a learning opportunity designed to help the human resources of the organization. Investment in human resource development is an expenditure aimed at increasing human productivity. With a good human resource development program, the organization will be competitive and able to compete positively [1], [2], [3]. The human potential will later be reflected in various aspects, one of which is the quality that can only be realized by developing human resources, [4], [5], [6], [7]. This is necessary because human resources are the most influential factor in life. The ability of humans to influence their nature shows that the position of human resources is very important. Therefore, to achieve this goal, a strategy is needed to achieve it.

The development of human resources is related to the availability of opportunities and the development of learning included making training programs that include planning, organizing, and evaluating these programs [8], [2]. From some of the definitions above, it can be said that human resource development is all activities carried out by an organization to advance its members to master the knowledge, skills, and attitudes needed to handle current or future jobs. The activities covered include not only education and training but also career development and organizational development. In other words, the development of human resources is closely related to

---

<sup>11</sup>Universitas Muhammadiyah Makassar, [asrijaya@unismuh.ac.id](mailto:asrijaya@unismuh.ac.id)

<sup>12</sup>Universitas Muhammadiyah Makassar, [ifayani.haanurat@unismu.ac.id](mailto:ifayani.haanurat@unismu.ac.id)

<sup>13</sup>Universitas Muhammadiyah Makassar, [nurlina3008@gmail.com](mailto:nurlina3008@gmail.com)

<sup>14</sup>Universitas Sang Bumi Ruwa Jurai, Bandar Lampung, [nuraeniharyo@gmail.com](mailto:nuraeniharyo@gmail.com)



efforts to increase the knowledge, abilities and attitudes of organizational members,

Human resource development strategies related to organizational improvement are human resource recruitment, education and training programs, leadership management and member motivation. Based on this strategy, human resource development aims to achieve organizational goals and improve performance and growth. Member training and development is a planned effort by an organization to improve the knowledge, skills, and abilities of members. Training focuses more on improving the ability to engage in a specific job, while development focuses more on future work.

The purpose of establishing the Indonesia Stock Exchange Investment Gallery is to introduce the capital market to the academic community from an early age. The Indonesia Stock Exchange Investment Gallery with those three in one concept in collaboration with the Indonesia Stock Exchange (IDX), universities and securities companies is expected to introduce the capital market not only in theory but also in practice, [9], [10], [11], [12]. In the future, through the IDX Investment Gallery, which already provided real-time information to learn to analyze stock trading activities, it is expected that it can be a bridge to the master of science and its practice in the capital market.

The Capital Market Study Group (KSPM) is the board that manages the investment gallery. The establishment of this organization is an embodiment of the student's caring spirit to participate in gaining knowledge, as well as disseminating capital market information. Until now, the KSPM in Makassar has facilitated the opening of securities accounts and has several educational activity programs such as the Capital Market School (SPM), capital market seminars, and regular discussions.

## **Discussion**

The human resources of the Capital Market Study Group (KSPM) should be able to provide capital market education to the academic community. However, the quality of the KSPM organization had declined. Due to the lack of educational programs that should be carried out, many academics did not understand the capital market, investment, and practice in the world of stock trading. While the human resources were very sufficient to be able to run the organization, lack of understanding of the capital market caused a lack of integration between each other, producing less in quality. Because KSPM is an organization that changes its management annually.

## **Human Resource Development Strategy**

Human resource management is a science or method of regulating the relationship and role of resources (labour) owned by individuals efficiently and effectively and can be used optimally so that the goals (goals) with the company, employees and society are maximized [13].

Human resources are one of the most important factors, and cannot even be separated from organizations, institutions and companies [14]. Human resources are also a key determinant of the company's development. In essence, the human resources that exist in the organization in the form of humans as a driver to achieve organizational goals. Therefore, the discussion of human resources is about individuals who work as drivers of organizations, institutions and companies and as assets whose abilities must be trained and developed. Human potential involves two aspects, namely aspects of quantity and quality [13].

The human potential will later be reflected in various aspects, one of which is quality which can only be realized by developing human resources. This is necessary because human resources are the most influential factor in life. The ability of humans to influence their nature shows that the position of human resources is very important. Human resources have strong strategic potential in an organization, meaning that human resources play an important role in carrying out activities to achieve goals. For this reason, human resources have a strong presence in the organization. To achieve better conditions, full management of human resources is required to create quality, loyal and superior human resources.

Human resource development is a process carried out to develop knowledge, skills, and work abilities. Likewise, the competencies developed through training and development, organizational learning, leadership management, and knowledge management for the benefit of improving performance. The challenge to build and sustain competitive advantage is not a short-term challenge, but a sustainable long-term challenge. Therefore, it is important for management to consider that the development and training program is a program that is as long-term and sustainable as these challenges [15], [16]

Human resource development is a continuous effort to improve the quality of human resources in the broadest sense, through education, training and coaching [17].

From some of the definitions above, it can be concluded that human resource development is all activities carried out by an

organization to advance its members to master the knowledge, skills and attitudes needed to handle current or future jobs. The activities in question are not only in the aspect of education and training but also involve aspects of career and organizational development. Human resource development needs to be carried out in a planned and sustainable manner so that development can be carried out properly and a human resource development program must be established. Development must aim to improve the technical, theoretical, conceptual and moral capabilities of the resources to achieve optimal results.

A well-formulated human resource strategy will help collect and allocate company resources into a unique entity based on its internal strengths and weaknesses, environmental changes, and anticipated competitor actions [18]). Because of the importance of human resources in implementing and achieving organizational goals, human resource management must pay attention to various aspects such as aspects of staffing, training and development, motivation and maintenance in more detail [4], [16].

A well-formulated human resource strategy will help pool and allocate company resources into a unique entity based on its internal strengths and weaknesses, environmental changes, and anticipated competitor actions. Because of the importance of human resources in implementing and achieving organizational goals, human resource management must pay attention to various aspects such as aspects of staffing, training and development, motivation and maintenance in more detail [4], [16].

## **Conclusion**

The strategy of developing human resources influence the performance of the management of the Capital Market Study Group in Makassar. Human resource management is a very important aspect of the general education process. Therefore, the functions in the management of human resources must be carried out optimally so that the needs concerning individual, company, organizational or institutional goals can be achieved. Human resource development is a very important thing to do because, with the development of human resources, the organization is concerned which means that it has adapted to the environment and development to achieve higher quality human resources. With the development of human resources in the sense of increasingly qualified members, of course, it surely further improves the performance of the organization concerned.

## References

- [1] M. Kadarisman, "Manajemen Pengembangan Sumber Daya Manusia, Cet-2 PT," *Raja Graf. Persada, Jakarta*, 2013.
- [2] A. Fatikhin, "Model Pengelolaan Sumber Daya Insani Di Lembaga Keuangan Mikro Syariah (Studi Di Kspps Bmt El Amanah Kendal)," *J. Ekon. Syariah dan Akunt.*, vol. 1, no. 2, pp. 9–16, 2021.
- [3] A. F. Hardityo, "Pengaruh Pelatihan Dan Pengembangan Sumber Daya Insani Terhadap Kinerja Islami Karyawan Pada Pt Jamkrindo Cabang Surabaya," *J. Ekon. dan Bisnis Islam*, vol. 4, no. 1, pp. 78–87, 2021.
- [4] Jusmaliani, *Pengelolaan Sumber Daya Insani / Jusmaliani*. Jakarta: Bumi Aksara, 2011.
- [5] A. Rohman and M. El, *Buku Ajar Manajemen Sumber Daya Insani*, vol. 63. Duta Media Publishing, 2017.
- [6] C. C. A, R. T. E, N. M. A, R. Alvina, and F. N. Latifah, "Sumber Daya Insani yang Diperlukan Lembaga Keuangan Syariah," vol. 1, pp. 1–22, 2021.
- [7] S. Aini, H. Sunandar, U. Islam, N. Sultan, and S. Kasim, "Terhadap Mutu Pelayanan Dan Kinerja Selama Era New Normal Pada Bmt Al-Ittihad Menurut Konsep," *J. Penelit. Sos. Keagamaan*, vol. Vol 21, No, pp. 82–102, 2021, [Online]. Available: ISSN:1693-8186. <http://ejournal.uin-suska.ac.id/index.php/Kutubkhanah/article/view/13356/6489>.
- [8] Kasmawati, "Pengembangan Sumber Daya Manusia Dalam Organisasi Pendidikan Islam," *J. UIN Alaudin*, vol. VIII, no. 2, pp. 392–402, 2019.
- [9] E. Murdiyanto, "Peran Galeri Investasi Bursa Efek Indonesia Dalam Meningkatkan Jumlah Investor Dan Transaksi Efek Di Jawa Timur," *J. Nusant. Apl. Manaj. Bisnis*, vol. 4, no. 1, p. 17, 2019, doi: 10.29407/nusamba.v4i1.12645.
- [10] D. Selasi, "Peran Galeri Investasi Terhadap Tumbuhnya Investor Saham Pada Lingkungan Kampus," *MASILE*, vol. 1, no. 1, pp. 208–239, 2021.
- [11] I. Sari, "Memahami Peranan Galeri Investasi Bursa Efek Indonesia Pada Masa Pandemi Covid-19," *Financ. J. Akunt.*, vol. 7, no. 1, pp. 26–37, 2021.
- [12] B. F. Oktary, W. Ramashar, and R. G. Suci, "Faktor yang Memengaruhi Minat Mahasiswa Berinvestasi di Pasar Modal Melalui Galeri Investasi di Pekanbaru," *Pros. Semin. Nas. Ekon. Bisnis Akunt.*, vol. 1, pp. 39–52, 2021, [Online]. Available: <https://ejurnal.umri.ac.id/index.php/sneba/article/view/2655>.
- [13] A. Hardana, "Manajemen Sumber Daya Insani," *Al-Masharif J. Ilmu Ekon. dan Keislam.*, vol. 3, no. 1, pp. 115–126, 2015.

- [14] A. T. Sulistiyani and Rosidah, *Manajemen sumber daya manusia : konsep, teori dan pengembangan dalam konteks organisasi publik*. Yogyakarta: Graha Ilmu, 2003.
- [15] S. R. Harahap, "Pengaruh strategi pengembangan sumber daya insani terhadap peningkatan kinerja dan mutu pelayanan pada PT. Bank Muamalat Indonesia, Tbk cabang Medan." Universitas Islam Negeri Sumatera Utara, 2016.
- [16] Kasmir, *Manajemen sumber daya manusia (teori dan praktik)*. Depok: PT Raja Grafindo Persada, 2016.
- [17] S. Ulber, "Asas-Asas Manajemen," *Bandung: Refika Aditama*, 2011.
- [18] H. Simamora, *Manajemen sumber daya manusia*. Yogyakarta: STIE YKPN, 2004.

# **Acts of Terrorism as a Crime Against Humanity Under International Law**

Aulia Rosa Nasution<sup>15</sup>

## **Introduction**

### **The Global Phenomenon of Terrorism in the 21<sup>st</sup> Century**

Terrorism has becoming one of the global issues since the incidents of September 11' 2001 in World Trade Centre which is a very serious crimes and threatens humans lives. Acts of terrorism with all the reasons and motivation behind it which committed by separatist group, anarchist, Marxist revolutionary, religious groups, political groups and many more, has marked them as terrorists, who directly carry out acts of terrorism to the societies and causing the death toll in large numbers. In general, terrorism arises because of national or political policies that treat unfairly certain groups. This injustice is then expressed in the form of violence, terror and even assasination, so it can be said that terrorism appears as a form of resistance to unjust tyranny by violent means.

Globalization has brought about a revolution in communications and transportation that has enabled terrorist plots to be planned and executed at transcontinental distances. For example, the 9/11 plot was organized in Afghanistan, Pakistan, Malaysia, Germany and other countries. Moreover, cheap and efficient air transportation has allowed terrorists, often with forged passports in hand, to travel the world for purposes of raising funds, spreading their ideology or recruiting new members. The internet also became the ultimate expression of the power of the information revolution. Some analysts and scholars have noted that the brand of terrorism nowadays represented by 9/11. This "new" type of terrorism characterized by the absence of state sponsorship, the presence of religious or millenarian ideologies and the inclination to use chemical, biology and nuclear weapons.

Terrorism not only develops locally but is built from members who operate to various countries so that it becomes transnational or transnational crime [8]. Terrorism acts also related to the globalization. Globalization, which should be a positive thing for the development of the world, is also one of the causes of the growth of transnational terrorism. Although globalization can improve the

---

<sup>15</sup> Universitas Medan Area, [Nasution82auliarosa@gmail.com](mailto:Nasution82auliarosa@gmail.com)

knowledge and technology of a nation, but globalization provides. However, globalization increasingly facilitates the spread of radicalism and terrorism ideologies through the sophistication of media and the internet that is used by many people.

### **Terror and Terrorism**

There are many definitions of terrorist but no universally accepted definition of terrorism until now, even the United Nation agencies haven't succeeded in making the official definition of terrorism. Literally, the word terrorism comes from the basic word "terrere" which means that fear is extraordinary, frightening, terrible which means to fear or scare. The word terrorism was first popularized during the French Revolution through the system or regime de la terreur of 1793-1794. It was designed to consolidate the new government's power by intimidating counter-revolutionaries, subversives and all other dissidents whom the new regime regarded as "enemies of the people" [8].

Terror is the tool with which Bin-Laden and his people aspire to make their vision a reality. Since the nineties, Afghan alumni have been involved in the majority of large-scale terror attacks all over the world. This terror system included the perpetration of terror attacks and mass killings. Terrorism has a diverse and broad understanding.

A. Schmid defines terrorism as '*a method of combat in which random or symbolic victims become targets of violence*'. Through the previous use of violence or the credible threat of violence, other members of a group are put in a state of chronic fear (terror) [10]. According to the U.S. Federal Bureau of Investigation (FBI), terrorism defined as '*the unlawful use of force or violence against persons or property to intimidate or coerce the government, the civilian population or any segment thereof, in furtherance of political or social objectives*' [3]. Meanwhile, the U.S. Department of Defense defines it as '*the calculated use of unlawful violence or threat of unlawful violence to inculcate fear; intended to coerce or to intimidate governments or societies in the pursuit of goals that are generally political, religious or ideological objectives*' [10].

Terror means the use of force to create or condition a climate of fear within a wider group of people, rather than just the fall of victims of violence. Terror is the tool with which Bin-Laden and his people aspire to make their vision a reality. Since the nineties, Afghan alumni have been involved in the majority of large-scale terror attacks all over the world. This terror system included the perpetration of terror attacks and mass killings [11].

Terrorism is the most widely accepted contemporary usage of the term, is fundamentally and inherently political. It is also ineluctably about power, the pursuit of power, the acquisition of power and the use of power to achieve political change [11]. Terrorism is thus violence or equally important, the threat of violence, which is used and directed in pursuit of, or in service of a political aim [2].

The existence of mass media publications is one of the goals of acts of violence from an act of terror, so that the perpetrators feel successful when the terrorist violence they commit can be published in the mass media. In its development the concept of terrorism developed into a method or technique of intimidation with systematic goals to realize a particular political interest [1]. Terrorism has the main objective of extensive publications through mass media. The mass media is also greatly benefited by the existence of sensational and spectacular news of violence and terror acts to increase the circulation of print media [9]. All kinds of reports both positive and negative about terrorism will be very valuable for the survival of terrorist organizations [11].

Terror can be understood as an activity that spreads fear even though sometimes it is understood as a word of state like an atmosphere of terror. Terrorists refer to the perpetrators of acts of terror while terrorism is understood as an attempt to create a frightening situation in certain specific ways such as suicide bombings, with specific objectives. Not every terror can be classified as terrorism but every terrorism is always an act of terror.

Some of the characteristics of terrorism that can be identified as following: 1) there is the use of violence in every terrorism action both by individuals and by certain groups, both by individuals and groups; 2) the purpose of terrorism is to deliberately spread fear in order to achieve a higher goal; 3) there are complex motives in the matter of terrorism such as national separatist, ideological, religious, economic, ethnocentric motives and also support from the sponsoring state.

Mahathir Mohammad said that the most important thing before knowing the terrorism, we must determine who a terrorist is. This is important because people who some people describe as terrorist are regarded as noble freedom fighters by some other. More confusing still, some are condemned as terrorist one day, only to be considered respectable people another day [7]. For examples, the Jewish Haganah, Irgun Zeva'I Le'umi, and Stern Gang were at one time regarded as terrorist and were haunted by the Britihs. But later they become respected leaders of Israels. Although the Jewish terrorist



group of the 1940s known as Lehi or Stern Gang after its founder and first leader, Abraham Stern, would admit to its effective use of terrorist tactics, its members never considered themselves to be terrorists [2]. Jomo Kenyatta and Robert Mugabe were described as terrorists and were condemned by the British only to become in the end the acknowledged leaders of independent states. The Irish Republican Army (IRA) is a terrorist organisation in the eyes of the British but are regarded as freedom fighters worthy of financial support by the American.

Unlike the ordinary criminal, the terrorist is not pursuing purely egocentric goals, he is not driven by the wish to line his own pocket or satisfy some personal need or grievance. The terrorist is fundamentally an altruist; he believes that he is serving a "good" cause designed to achieve a greater good for a wider constituency whether its real or imagined, that the terrorist and his organizations purport to represent. The terrorist is fundamentally a violent intellectual, prepared to use and indeed, committed to using force in the attainment of his goals.

### **'State' and 'Non-State Terrorism'**

Generally, acts of terrorism can be categorized into two kinds. The first is a 'State Terrorism' or 'State Sponsored Terrorism' and the second is a 'non-State Terrorism'. 'State Terrorism is a use of terror by a government as an instrument to subjugate other party to achieve governments purposes. State Terrorism is likely occurred in the authoritarian and repressive government. In other words, this kind of authoritarian and repressive government always using terror as their instrument to intimidate anyone against their policies. State terrorism usually always receives support from the government for policies on the use of violence, coercion and intimidation. These acts of violence and coercion are intended to fight enemies who are considered to have threatened state security [5].

The Reign of Terror, which led by radical Jacobin-dominated government, is a good example of State Terrorism carried out to further the goals of a revolutionary ideology. During the Terror, thousands of opponent to the Jacobin dictatorship were arrested and put on trial before a Revolutionary Tribunal. Those found to be enemies of the Republic were beheaded by a new instrument of execution called 'the guillotine' which has the capability to execute victims. Between 17,000 and 40,000 persons were executed and perhaps 200,000 political prisoners died in prisons from disease and starvation [4].

Until now there are two categories of terrorism known to the international community. First is the terrorism group that emerged from below (*terrorism from below*). For example the radical rebel groups, the minorities who became opposites of the Government and using political violence which aimed at opposing state power or government like the *Palestinian Liberation Organization* (PLO), *Irish Republican Army* (IRA) in North Ireland, the Kashmiri extremist groups which operated in the borders of Pakistan and India. Second is state terrorism. State terrorism always uses violence and threats carried out by governments that have the authority to fight civilians who represent terrorism from the above (*terrorism from above*). State terrorism is usually carried out in an authoritarian and stressful government regime. Examples are the regime's terrorist acts carried out by Stalin against the civilian population of the Soviet Union, and the atrocities committed by Saddam Hussein against Iraq. When Mao Zedong came to power in China, the "reign of terror" also conducted by its government. Between the years of 1950-1953, about 10-20 million people were destroyed. The same thing also conducted by dictator Pol Pot who has committed to 3 million of its 8 million people through his government agency and the Khmer regime.

On the other hand, 'Non-State Terrorism' is a terror used by non-State actor by individual or certain group of people against the people or government with any motives behind. For example, the terrorist group of Bali Bombing which was led by Imam Samudera, the terrorist group of Noordin M. Top from Jemaah Islamiyah, the radical terrorist Group of Santoso which has conducted many acts of terror in Poso, Sulawesi, Indonesia and also include the radical terrorist group of Abu Sayyaf who committed murder and hostages in the south areas of Philippine.

The acts of terrorism which committed by some countries such as Iran, Afghanistan, Libya, Syria and North Korea, also can be labelled as 'State Sponsored Terrorism' which has the following characteristics. First, they conducted actual and direct acts of terrorism, like North Korea which has destroyed the aircraft of South Korea; Afghanistan who sent the agent to Pakistan to carry out bombings widely in various regions. Second, provide direct support and encouragement and material assistance to terrorist groups to carry out attacks on a target within a country (for their own purposes or other countries purposes), by voicing a message from the sponsoring country. For example, Iran and Libya often conducts acts of terrorism by using local terrorist groups in a country to convey messages and interest of the sponsored country. Another example like Bali Bombing, JW. Marriott bombing and Australian embassy bombing

in Jakarta are conducted by terrorist groups who get supports from the sponsored country for their benefits. Third, they provided weapons, explosives, protection and shelter and instilling their ideology as justification of acts of terrorism.

### **Terrorism: a Crime against Humanity**

The term of a crime against humanity was first recognized in the joint declaration between France, United Kingdom and Russia on 24<sup>th</sup> of May, 1915. This declaration was intended to condemn the Turkish atrocities that have been made during the war against Armenians in Turkey. This massacre of Armenia's population known as a 'crime against humanity'. The 1945 Charter of the Military Tribunal at Nuremberg identified three classes of international crime; a) Crime Against Peace; b) War Crimes; c) Crimes Against Humanity. Even the Statute of International Criminal Court list four categories of crimes to be prosecuted by the ICC; a) the crime of genocide; b) the crime of aggression; c) war crimes and crimes against humanity.

Crime against humanity usually conducted in a systematic way and causing physical or mental suffering, or killing of human beings that are contrary to human civilization as well as violating the principles of international law. Crime against humanity is a criminal act which creates the condition of individuals and communities in an atmosphere of terror. In the perspective of human rights, crimes against humanity can be classified to gross violation of human rights, if the acts committed as part of a 'widespread' and 'systematic' attack, directed against the civilian population, which is committed against innocent civilians like the Bali bombing incidents.

Crime against humanity was known for the first time in the London Charter of the International Military Tribunal (IMT) 1915, which resulted the Nuremberg Trial that prosecuted the German NAZI war criminals. In the Article 6 (c) of Nuremberg Charter, "*Crime against humanity is defined as: murder, extermination, enslavement, deportation and other inhuman acts committed against any civilian population, before or during the war, or persecutions on political, racial or religious grounds in execution of or in connection with any crime within the jurisdiction of the Tribunal, whether or not in violation of the domestic law of the country where perpetrated*".

In the Judgment of the International Military Tribunal for the Trial of German Major War Criminals it was also stated that the Tribunal therefore cannot make a general declaration that the acts before 1939 were crimes against humanity within the meaning of the Charter, but from the beginning of the war in 1939 war crimes were committed on a vast scale, which were also crimes against humanity; and insofar as the inhumane acts charged in the indictment, and

committed after the beginning of the war, did not constitute war crimes, they were all committed in execution of, or in connection with, the aggressive war, and therefore constituted crimes against humanity.

Crimes against humanity completely and clearly stated in the Statute of the International Criminal Court (ICC) which is known as the Rome Statute, 1998. In the article 7 of the Rome Statute, crime against humanity defined as *“any of the following acts when committed as part of a “widespread” or “systematic attack” directed against any civilian population, with knowledge of the attack: (a) murder; (b) extermination; (c) enslavement; (d) deportation or forcible transfer of population; (e) imprisonment or other severe deprivation of physical liberty in violation of fundamental rules of international law; (f) torture; (g) rape, sexual slavery, enforced prostitution, forced pregnancy, enforced sterilization, or any other form of sexual violence of comparable gravity; (h) persecution against any identifiable group or collectivity on political, racial, national, ethnic, cultural, religious, gender as defined in paragraph 3, or other grounds that are universally recognized as impermissible under international law, in connection with any act referred to in this paragraph or any crime within the jurisdiction of the Court; (i) enforced disappearance of persons; (j) the crime of apartheid; (k) other inhumane acts of a similar character intentionally causing great suffering, or serious injury to body or to mental or physical health”*.

Crimes Against Humanity often committed in the times of peace, as well as during internal wars and international wars. Thus, from the formulation of Article 7 we can see that the Rome Statute of 1998 already contained the basics of an act or acts that qualify as crimes against humanity which condemned by the international community as a crime against human civilization (*Hostis Humanis Generis*). Based on the elements of crimes against humanity that have been regulated in Article 7 of the Statute of the International Criminal Court , the acts of terrorism can be classified as 'crimes against humanity'.

Even though acts of terrorism are not included in the jurisdiction of the International Criminal Court (ICC), various acts of terrorism contain many elements which belonging to crimes against humanity. According to Cheriff Bassiouni, terrorism as a crime against humanity can be characterized by several things as follows: 1) special crimes committed as part of state policy, 2) actions based on emphasis and discrimination on a group whose personality can be identified, 3) actions referred to as crime in national criminal law of a country; 4) the crime is committed by an official or state official or agency agent

related to a policy; 5) the crime can be attributed to war in a legal charter [6]. In order to establish a person as a perpetrator of a crime against humanity there must be an act carried out with awareness or knowledge that the action is deadly, carried out extensively or systematically against the civilian population and it's a continuation of a policy carried out by State and certain groups (non-state).

## **Conclusion**

The conclusions of this study are as follows. First, acts of terrorism constitute a crime against humanity because the acts of terrorism often conducted systematically, widespread, organized by State actors or non-State actors, causing death and serious injury, targeting civilian people and military objects, and violates the humanity. Secondly, terrorism acts nowadays widely practiced by non-state Actor rather than state actors because non-state actors are easier, faster and more comfortable to organize and facilitate the devices and the people who will be involved in the acts of terrorism and even the states who will support the terrorism acts. Thirdly, the International Criminal Court (ICC) can be used as the right tool in dealing with terror crimes in the future because it has the potential to prosecute acts of terror where this court has a special juridical to prosecute serious crimes such as war crimes, aggression, genocide and crimes against humanity . Even though terrorism has not yet entered the ICC jurisdiction, terrorism has many elements of crime against humanity which will be potential to be prosecuted as a crime against humanity.

## **References**

- [1] A.M. Hendropriyono, *Terorisme Fundamentalis Kristen, Yahudi dan Islam*, Penerbit: Buku Kompas, Jakarta: 2009
- [2] Bruce Hoffman, *Inside Terrorism*, Columbia University Press, 2006
- [3] FBI, *Terrorism 2002/2005*, <https://www.fbi.gov/stats-services/publications/terrorism-2002-2005>
- [4] Griset, Pamala L, and Sue Mahan, *Terrorism in Perspective*, Thousands Oaks, CA: Sage, 2007
- [5] Jawahir Thontowi, *Terorisme Negara Kerjasama Konspiratif Menjinakkan Islam Fundamental*, UII Press, Yogyakarta, 2013
- [6] King Faisal Sulaiman, *Who is the Real Terrorist, Mengungkap Mitos Kejahatan*, Elmaterra Publishing, Yogyakarta: 2007
- [7] Mahathir Mohammad, *Terrorism and The Real Issues* ,Pelanduk, Malaysia, 2003

- [8] Obsatar Sinaga dkk, *Terorisme Kanan Indonesia Dinamika dan Penanggulangannya*, Penerbit : Elex Media Komputindo, Jakarta : 2018
- [9] Sukawarsini Djelantik, *Terorisme Tinjauan Psiko-politik, Peran Media, Kemiskinan dan Keamanan Nasional*, Buku Obor, Bandung : 2010
- [10] Schmid, A. 1983. *Political Terrorism: A Research Guide to Concepts, Theories, Data Bases and Literature*. New Brunswick: Transaction
- [11] Yoram Schweitzer & Shaul Shay, *The Globalization of Terror The Challenge of Al Qaida and the Response of the International Community* , Transaction Publishers, New York, 2003

# Prophetic Legal Science Paradigm in the Era of Society 5.0

Auliya Khasanofa<sup>16</sup>

## Introduction

Humans now live in a modern civilization that demands everything fast, effective, and efficient. The modern term seems to be an identity that must be attached to all the devices of human life today. In addition to modern terms, it is considered ancient, traditional and out of date. The impact of rapidly changing times along with the development of science and technology has brought us into the digital era with all its sophisticated knick-knacks, including the loss of time and space barriers between countries.

The concept of Society stems from Society 1.0 which means a group of people who hunt in harmony with nature. Furthermore, Society 2.0 is a group concept of agricultural cultivation, organizational progress, and country development. Then, Society 3.0 is the concept of a society that is able to encourage industrialization and facilitate mass production through the industrial revolution. Meanwhile, the concept of Society 4.0 identifies the information society to realize greater added value by connecting intangible assets through information networks. The era of society 5.0 is a breakthrough in the concept of an information society that is built on society 4.0 and aims to create a prosperous human-centered society where everyone will enjoy life to the fullest.

Industry 4.0 is what has been passed, which is the latest trend of automation and data exchange in factory technology. The scope of cyber-physical systems, the internet for everything, cloud computing, and cognitive computing are well known developments in the field of information technology. By observing these conditions, it is hoped that this time it will become a revival point for the development of national law that does not only accommodate ideological and philosophical interests originating in the original culture of the Indonesian nation, namely Pancasila with a prophetic legal science paradigm that accommodates advances in information technology in the development of industry 4.0 so that it is easy in adapting to the era of society 5.0.

---

<sup>16</sup> Muhammadiyah University of Tangerang

The legal science paradigm until era 4.0 rested on the positivistic legal science paradigm which had been in the corridor of modernism-positivism hegemony (Newtonian paradigm). The positivistic legal paradigm with the doctrines of empiricism, objectivism, and rationalism was criticized by post-positivistic postmodernists by prioritizing the meaning behind it which became more open and intact. It can be said that science from time to time undergoes changes which usually start from changes in the paradigm used to Industry 4.0 [1]. The positivistic legal paradigm views law in its form as a rule, which determines what is allowed and what cannot be done.

Positivistic legal science is prescriptive, which is to determine what is wrong and what is right. In other words, positivistic jurisprudence studies law in books. The area of positivistic law is *dassollen* (what should be). This condition continues to color the process of law-making and enforcement until now, which has entered the era of society 5.0. Laws that are too formal, rigid and inflexible, and apply nationally have difficulty accommodating the rapid development of information technology. Laws that have been built so far with the construction of legality principles, territorial principles, and actions are seen as physical. Law is also increasingly pragmatic with the aim of if accommodating all problems in society or containing the political economy goals of the rulers, all of which are clearly temporary and local (sectoral-locality).

The legal science developed by the West, which is thick with modern science, adheres to a materialistic ideology, the purpose of science is to explain the physical world, it clashes with the purpose of religion which explains the spiritual realm. Science thinks that science has no philosophy and only studies and measures things empirically. In fact, science also has a philosophy: science only attaches importance to empirical objects. Science does not train its adherents to think philosophically, they will only study various types of formulas and technology [2]. This situation makes modern Western scholarship the basis for the presence of positivistic law to be misunderstood and experiencing an extraordinary crisis. The aridity of religious values leads to the destruction of Western civilization itself.

The crisis of positivistic legal science endangers the era of society 5.0 which combines forms of social intelligence that can strongly integrate between transcendental, physical, and cyberspaces. Thus, the era of society 5.0 can be understood as a form of community life that combines data through information technology to encourage the improvement of human resource intelligence in developing



various opportunities that can be implemented based on spiritual and humanities aspects in order to solve various social problems.

According to Capra, the inability of the positivistic legal science paradigm to return to view human life with a complete view has caused a crisis in the intellectual, moral, and spiritual dimensions of humans [3]. Modern life, especially in the West, gave birth to positivistic jurisprudence, as shown by Fritjof Capra during a turning point. Until era 4.0, positivistic legal science degraded human dignity (dehumanization). The positivistic science of law brought by Western civilization has many problems that are harmful to human civilization entering the era of society 5.0.

The epistemological crisis of modern science, which has been referred to since its existence, lies in the way of thinking of modern scientists which only comes from and relies on ideas (rationalism) both idealistic (Platonism-Cartesian) and empirical (Aristoteleism-Baconian) giving birth to a way of knowing with a materialistic, pragmatic character, hedonists and atheistic are wrapped in the auspices of the philosophy of positivism. It is proven by the occurrence of dehumanization because it exalts humans more than anything else which then falls into a multidimensional crisis because humans lose clear and definite instructions.

## **Discussion**

The idea of a paradigm was originally pioneered by Thomas Kuhn, *The Structure of Scientific Revolutions*, aiming to challenge the general assumption that holds about the way in which science changes. Kuhn formulates the paradigm as (1) a fundamental image of what is the main problem of science at a certain time, (2) normal science is a period of accumulation of knowledge, (3) the scientific work will inevitably give birth to new works that cannot be explained by science. previous knowledge, (4) the stage of the crisis will occur inconsistency (anomaly) is increasing and will only be answered with the model of the revolution of science (scientific revolution) [4]

The idea of a paradigm was originally pioneered by Thomas Kuhn, *The Structure of Scientific Revolutions*, which aims to challenge generally accepted assumptions about the way science changes. Kuhn formulated the paradigm as (1) a fundamental picture of what is the main problem of science at a certain time, (2) normal science is a period of accumulation of knowledge, (3) scientific works will inevitably give birth to new works. that cannot be explained by science. prior knowledge, (4) the crisis stage will occur inconsistencies (anomalies) which are increasing and will only be answered with a scientific revolution model [4]

### **Urgency to Present the Paradigm of Prophetic Law in Era 5.0**

The dimension of the transcendental basis is described in the prophetic legal science paradigm with the concepts of humanization, liberation, and transcendence by Kuntowijoyo [5],[6] used in discussing social science in general. In this case, the element of transcendence must be the basis of other elements in the development of science and civilization. The method of developing science and religion which is known as prophetic based on the Qur'an and Sunnah is the main basis for the overall development of science. The prophetic pioneered by Kuntowijoyo resembles the concept of integration of science and religion by Amin Abdullah, the concept of Islamization of science according to Naquib al-Attas and Ismail Raji al Faruqi. Profession later also became the paradigm of legal science in Indonesia. With the concept of humanization, liberation, and transcendence of legal science, it was built in order to find an epistemology of legal science that is able to answer legal problems in Indonesia. Humanization is an attempt to re-elevate human dignity through God's way. Liberation is a legal science that has a prophetic responsibility to free people from evil. Transcendence is a form of jurisprudence that contains the basic elements of faith in God [7].

The prophetic jurisprudence paradigm views the basis of science as having intuitive (faith) or a priori instructions. Due to its intuitive nature, knowledge starts from human receptive abilities to what is bestowed from revelation or guidance, therefore the prophetic paradigm rejects the views of Descartes's doubts or certainty. Derida's uncertainties. In the prophetic paradigm develop the existence of knowledge relations in humans arising from the organs of understanding, including; the senses or sense both the outer and inner senses, inspiration or intuition located in the heart or heart, ratio as a function of thinking and revelation that was revealed to the prophet. The consequence of this is the existence of prophetic integrity which is an emancipatory awareness: transcendence, humanization, liberation and historical activism: appreciation or involvement of thoughts and feelings in something that is believed (as the basis of all ethos/values); Devotion; Scientific work ethic; Humanity work ethic, which consists of: honesty; thoroughness/accuracy; criticality and appreciation [6]. Prophetic law is rooted in God's will for His creatures which was revealed through His Prophets and Messengers, the Mualim and Aulia who are always istiqomah and hold fast to the divine line or sunnatullah. Sunnatullah is the basis of the philosophy of natural law or natural law, which is explained through His verses, both

written (the Book and the Sunnah) as well as those that are described in the universe and the reality of life.

The word prophetic comes from the English word 'prophet', which means prophet. According to the Oxford Dictionary 'prophetic' is (1) "Of, pertaining or proper to a prophet or prophecy"; "having the character or function of a prophet"; (2) "Characterized by, containing, or of the nature of prophecy; predictive". So, the meaning of prophetic is to have properties or characteristics like prophets, or to be predictive, to predict [8].

The word prophetic comes from the English word 'prophet' which means prophet. According to the Oxford Dictionary 'prophetic' is (1) "Of, pertaining to or proper to a prophet or prophecy"; "having the nature or function of a prophet"; (2) "Characterized by, containing, or of a prophetic nature; predictive". So, what is meant by prophetic is having properties or characteristics like the prophets, or being predictive, to predict [8].

Normatively conceptually, the normative legal paradigm is based on Surah Ali-Imran verse 110 which means: "You are the best ummah who was sent down/born in the midst of humans to command the good and prevent evil and believe in Allah". Based on this verse, there are three main pillars that underlie the emergence of prophetic education, namely; amar ma'ruf (humanization) which implies humanizing humans, then nahi munkar (liberation) implies liberation, and tu'minunu billah (transcendence), the dimension of human faith.

The first element is humanization. Humanization is a creative translation of Amar ma'ruf whose original meaning is to advocate or enforce virtue. In Prophetic Social Sciences, humanization means humanizing humans, eliminating "materials", dependence, violence, and hatred from humans. Humanization is in accordance with the spirit of Western liberalism. It just needs to be added immediately, if Western civilization was born and rests on anthropocentric humanism, Kuntowijoyo's concept of humanism is rooted in theocentric humanism. Therefore, humanization cannot be fully understood without understanding the concept of transcendence on which it is based. Western humanism was born out of rebellion against the dogmatic power of the Church in the Middle Ages. The anthropocentric view assumes that life is not centered on God but on humans. Its ethos is the spirit of appreciating the values built by humans themselves.

Anthropocentric civilization makes humans the benchmark of truth and falsehood, to use humans as a criterion of beauty, and to give importance to that part of life that promises human power and pleasure. Anthropocentrism considers humans as the center of the

world, therefore they feel enough with themselves. Anthropocentric humans feel they are masters of themselves. Not only that, he also went further, he wanted to be the ruler of others. The universe then becomes the target of his lust for power which is getting more and more out of control.

The prophetic law paradigm presents theocentric humanism instead of anthropocentric humanism to re-elevate human dignity. With this concept, humans must focus on God, but the goal is for the benefit of humans (humanity) themselves.

The second element in the paradigm of prophetic law is the liberation which exists in empirical reality, so that liberation is very sensitive to the problem of structural oppression or domination. The phenomenon of poverty born of economic inequality is an important part of the liberation project. Liberation places itself not in the field of abstract human morality, but in the empirical reality of humanity, which is concrete. Kuntowijoyo even considers that avoiding the concrete to the abstract is one of the characteristics of thinking based on myths.

Transcendence is the third element of the prophetic legal science paradigm. Transcendence is the basis of the other two elements. Transcendence is a concept derived from *tu'minuna bi Allah* (belief in Allah). Transcendence wants to make transcendental values (faith) an important part of the process of building civilization. Transcendence places religion (Islamic values) in a very central position in the Prophetic Social Sciences. Transcendence is the basis of humanization and liberation. Transcendence gives direction to where and for what purpose humanization and liberation are carried out. Transcendence in the paradigm of prophetic law, besides functioning as a valuable basis for the praxis of humanization and liberation, also functions as a critique.

With the critique of transcendence, technical progress can be directed at the service of human development and humanity, not its destruction. Through transcendence, critical society will be freed from materialistic consciousness - in which one's economic position determines his consciousness - to transcendental consciousness. Transcendence will be the benchmark of human progress and decline.

The era of society 5.0 has the main goal, namely to create prosperity through economic growth and technological development to all levels of society (Wasitarini, 2019). The era of society 5.0 refers to the concept of applying technology to the industrial revolution 4.0 which pays attention to the humanities aspect to give birth to ways to solve social problems (Faruqi, 2019). Then, the era of society 5.0 is a form of social intelligence that can strongly integrate between

physical space and cyberspace (Salgues, 2018). Thus, the era of society 5.0 can be understood as a form of community life that combines data through information technology to encourage the improvement of human resource intelligence in developing various opportunities that can be implemented based on the humanities aspect to solve various social problems.

The new enlightenment entered the era of society 5.0 by replacing the paradigm of positivistic legal science which created a multidimensional crisis with the prophetic legal paradigm in line with the theory of Al-ta'wil al-ilmi proposed by M. Amin Abdullah by using the combination of bayani, irfani, and burhani methods. As it is known that the Bayani method works to find the truth by interpreting the text. Empirical facts are understood and interpreted through texts. Furthermore, the irfani method provides enlightenment in knowing the nature of divine truth, the source of which is based on deep inner experience, holy, in accordance with logic. Regarding the results of the validity of the Irfani method, those who feel it are inner intuition. The approach using the burhani method refers to the use of logic that gives birth to conclusions. kesimpulan secara pasti dan mudah dicerna secara rasional dan tentu saja logis [10].

Integration of science, technology and values so that humans become wise and wise to nature and everything in it. So the science of law that is developed entering the era of society 5.0 must be based on values such as: first, monotheism, that all of nature, the universe, and the earth and all of its contents are intended for humans, with science humans can know and the universe. By will, humans walk towards the choice to do good or bad. Seeking God's Will; second, leadership, namely the presence of humans on earth in order to carry out the function of the caliph as a leader on earth (QS. 2:30); third, Trust and Devotion, when a leader is given a mandate by Allah to love what is on earth and in the sky, everything is done in the context of devotion to Allah (Surah 51: 56); fourth, Sharia for the realization of human goodness and justice must carry out daily life in accordance with sharia rules that provide solutions and peace of human life itself.

## **Conclusion**

1. Positive legal science creates a multidimensional crisis that endangers human life entering the era of society 5.0
2. The prophetic legal paradigm is oriented towards the benefit of human beings with the light of God. The prophetic law paradigm becomes new enlightenment in the midst of positivistic legal hegemony. With the prophetic legal paradigm, the search for and discovery of human legal values is free from materialistic-secular

legal methods, far from divine values (transcendental) as is currently happening in modern times in entering the era of society 5.0.

## References

- [1] Absori, "Epistimologi Ilmu Hukum Transendental dan Implementasinya dalam Pengembangan Program Doktor Ilmu Hukum," 2015.
- [2] T. A. Amal, *Islam dan Tantangan Modernitas, Studi Atas Pemikiran Hukum Fazlur Rahman*. .
- [3] S. Raharjo, *Hukum dalam Jagad Ketertiban*. Jakarta: UKI Press, 2006.
- [4] T. Kuhn, *The Structure of Scientific Revolution*. Chicago: University of Chicago Press, 1962.
- [5] H. S. A. Putra, "Paradigma Profetik, Mungkinkah, Perlukah," Yogyakarta, 2011.
- [6] Absori, K. Wardiono, and S. Rochman, *Hukum Profetik, Kritik terhadap Paradigma Hukum Non-Sistematik*. Yogyakarta: Genta Publishing, 2015.
- [7] D. Khudzaifiah, *Pemikiran Hukum: Kontruksi Epistimologis Berbasis Budaya Hukum Indonesia*. Yogyakarta: Genta Publishing, 2014.
- [8] "oxfordlearnersdictionaries," 2021. <https://www.oxfordlearnersdictionaries.com/definition/english/prophetic?q=prophetic> (accessed Dec. 18, 2021).
- [9] M. D. Raharjo, *Enslikopedia Al Quran*. Jakarta: Paramadina, 1997.
- [10] M. A. Abdullah, *Islamic Studies di Perguruan Tinggi*. Yogyakarta: Pustaka Pelajar, 2010.

# IP Appraiser Role in the Implementation of Copyright as a Collateral in Indonesia

Cita Yustisia Serfiyani<sup>17</sup>

## Introduction

The use of intellectual property rights as credit guarantees must require a certificate of proof of copyright ownership as one of the conditions for submitting a credit application [8]. Copyright indeed adheres to the principle of being declarative and not required to make notes. Still, the recording of copyright in the form of creation strengthens the legal position of the creator and copyright owner in actions such as entering into credit agreements with the imposition of guarantees.

Nowadays, we cannot apply the practice of underwriting creations as objects of fiduciary bank credit guarantees because the legal concepts and calculations have not been prepared technically by the Government [1]. Copyright's position, which is currently still additional collateral, needs to be increased to be equivalent to the main collateral. Suppose the concept of guaranteeing intellectual property rights, especially Copyright as the main fiduciary collateral, has been carefully prepared by the Government. In that case, it is necessary to revise PBI Number 14/15/PBI/2012 and PBI Number/9/6/PBI/2007 with adding property rights as an object of fiduciary collateral recognized by the Bank. As long as IPR has not been stipulated in a Bank Indonesia Regulation as a valid fiduciary collateral object and the practice of banking credit guarantees cannot use it [4]. However, it can still be used as an object of credit guarantee in lending and borrowing agreements outside banking and non-banking financial institutions based on consensuality and the principle of freedom of contract.

The obstacle in implementing the work as the main collateral is that the Government has not yet found the right concept for evaluating the work and the legality of the work as collateral for credit. Although Intellectual Property is seen as a movable object, it is different from other non-intellectual property movable objects so that the way of interpreting its value is also different. This characteristic will have implications for other matters and is certainly better understood by those in the intellectual property field, such as a

---

<sup>17</sup> Universitas Wijaya Kusuma Surabaya

certified intellectual property rights Consultant. On the other hand, a certified intellectual property rights consultant alone is not enough to be appointed as a professional intellectual property assessor. Intellectual property rights consultants still have weaknesses in their ability to estimate the economic value of goods in detail without the help of a public appraiser. Certified intellectual property rights consultants do not necessarily understand the new issue of intellectual property rights as credit guarantees and the need for uniform understanding.

In this case, the appraisal agency's role is crucial; the assessment of intellectual property rights as credit guarantees cannot be carried out by bank employees alone or ask for assistance from the professional services of public appraisers. Therefore, a new institution or profession is needed to carry out the role of assessing the object of intellectual property rights guarantees who understand the legal characteristics of Intellectual Property Rights as a type of property that is different from other assets.

### **The Concept of Valuation of Copyright Objects**

Intellectual Property has seen as a movable object, although it is different from other non-intellectual property movable objects so that the way of interpreting its value is also different. For example, a car as a movable object and a painting as a movable object are burdened with fiduciary guarantees. However, when the ownership of the car is transferred to the creditor due to a default, the debtor's ownership rights to the car are entirely lost, while in paintings, only the object of painting as a form of creation or only the economic rights of creation can be transferred to the debtor because the moral rights of the creator to the painting cannot be a switch so that at any time he has the right to be respected as the creator of the painting. The agreement between the Debtor and Creditor consists of a credit agreement as the main agreement and a fiduciary guarantee agreement as an additional agreement or *accessoir*. Evidence of the agreement must be reported to the Directorate General of Intellectual Property.

The legal object in the copyright agreement can be in the form of copyright alone or including the object of creation as long as the legal subject can control the object of ownership [5]. This is because the object of creation must be in the form of a moving object. There are tangible and intangible movable objects. Tangible movable objects (e.g., statues, paintings) can be encumbered with fiduciary and fiduciary guarantees. Intangible movable objects (e.g., songs, films) can only be encumbered with fiduciary guarantees even though the



imposition of a fiduciary guarantee has been regulated while the pawn is not/has not been regulated.

The mechanism for imposing collateral that is already known is fiduciary because copyright is considered an intangible movable object. However, actually "creations," especially those that have been realized in the form of fixed objects, both movable and immovable objects that the Mortgage Law cannot guarantee, logically can be guaranteed using a pledge. If the method of pawning is taken, the creation is in the control of the pawnbroker (the debtor) for the duration of the agreement. So, in a pledge, collateral held is the object of his creation. Therefore this method can only be applied to tangible movable objects. For example, a pledge for a whole sculpture that is feared to be lost/damaged/duplicated as long as the debt has not been paid off, the artwork should be pledged as collateral for the security of the goods for creditors. A pawn is different from a fiduciary in that it is only in possession of the object, not in the transfer of ownership [7]. Pawning has not been regulated in the Copyright Act, so this option does not need to be discussed further at this time. It is only a suggestion.

Furthermore, in loans with fiduciary guarantees, for example, for paintings, the painting remains under the control of the creator/painter even though the debt has not been paid off. The debtor continues to hold the painting for the duration of the agreement. The creditor keeps the function of the copyright certificate on the painting as proof of the authenticity of the painting and the validity of the ownership of the painting by the debtor, along with the completeness of the credit agreement. Likewise, when the creation has been realized but is transferred to another party through a particular agreement, the proof of the agreement is included in the object of the guarantee. So, in a fiduciary, creation as an object of guarantee that is held is not the object of creation directly, but the copyright, which is proven based on the right with a document.

The following include objects of copyright guarantee:

1. The created object itself (to be bound fiduciary as a complement to the copyright)

**Table 1 the following include objects of copyright guarantee**

<b>Objects of Copyright</b>	<b>Object existence</b>	<b>IPR certificate</b>	<b>License &amp; royalty agreement</b>	<b>Agreements from neighboring rights</b>
Papers		V	V	
Songs or music with or		V	V	V

without subtitles			
Drama, musical drama, dance, choreography, puppetry and mime		V	V
Works of art in all forms such as painting, drawing, carving, calligraphy, sculpture, or collage	V	V	V
Architectural works		V	V
Batik arts or other motifs		V	V

- 
2. Certificate of proof of copyright ownership
  3. Agreement on the transfer of economic rights, for example license agreement, royalty agreement.
  4. Agreements were arising from neighboring rights. Related Rights are rights related to Copyrights, exclusive rights for Performers, Phonogram Producers, or Broadcasting Institutions.

The four types of guarantee objects can be applied to all three or one of them optionally depending on the conditions and types of creations, according to the description as follows:

Studying Copyright as an intangible movable object is undoubtedly challenging to determine the rupiah's value [6]. Creations that have been realized in a tangible form, the object of guarantee can be assessed in terms of:

1. The moral value of creation
2. The current economic value of this creation  
The value of the creation may increase or decrease every year until the term of the agreement expires (profits and losses). Professional IPR appraisers can only estimate this point.
3. The capital expended in producing the creation.  
This point is optional, depending on the shape of the creation. This point does not apply if the creation has minimal production capital

such as songs, paintings, textbooks. However, it can still have high economic benefits if it is successful in the market.

4. The economic value of the work stated in the license agreement and the royalty payment agreement between the creator and other parties, if any (involves the role of the relevant Collective Management Institution to help check the validity of the agreement and the suitability of the value stated in the agreement with the real economic value in actual practice).

Some requirements for completeness:

1. IPR certificates
2. A letter of agreement with a third party if the work is being transferred to its economic rights through a license if any (does not apply to works whose economic rights have been transferred by way of a drop-off)
3. Creator's personal information
4. History of the creator in the OJK Financial Information Service System (SLIK)

### **The Role of the IP Appraiser in IPR Valuation**

The difficulty of intellectual property valuation is a different obstacle in applying and formulating legal rules in intellectual property as credit guarantees. In addition to the calculation formula that is not yet available, problems regarding the capabilities and expertise that need to be mastered by a person or an institution responsible for conducting inspections and calculations of intellectual property as credit guarantees have also not been solved. So far, the registration of the object of intellectual property rights and all administrative matters are assisted by the Consultant of intellectual property rights. However, the competence of intellectual property rights consultants to evaluate intellectual property is still not qualified.

The role of intellectual property appraisers is essential. The reason is that the bank needs certainty of the value of copyright that the prospective debtor guarantees [2]. In addition to requiring a competent professional valuator, there is also a need for clear legal rules regarding indicators in the creation valuation process because intellectual property assets are intangible assets derived from rights or privileges obtained by an entity from owning these assets. Although some intangible assets can have a physical form, they are still intangible.

The Intangible Assets must have the criteria, subject to specific identification and identifiable description, existence and legal protection, private property rights, and legally transferable private

property, demonstrated by some tangible evidence of existence, has been created or has existed in an identifiable time or as a result of an identifiable event, their extinction or cessation of existence at an identifiable time or as a result of an identifiable event, defined by specific legal rights, and recognized for accounting, taxation or legal purposes.

In practice in Indonesia, the company conducts an assessment of its IPR for a transaction, internal use, and other purposes. The assessments carried out so far by the appraiser profession are based on the Indonesian Appraisal Code of Ethics (KEPI) and the Indonesian Assessment Standard SPI [3]. Even though IPR consultants have been certified in the future, they still have to receive materials/training on assessing IP as an object of guarantee as evidenced by a training certificate. IPR Consultants who have passed the training, apart from being known as Intellectual Property Rights Consultants, are also entitled to the status of professional appraisal of IP guarantee objects.

The expertise they must possess must adapt to the characteristics of each type of intellectual property that is different from one another. One of the aspects is about the timeframe. Works have the most extended term of protection. The brand has a term of 10 years and can be extended. Other industrial property rights vary from 10 to 20 years but are not renewable.

IP consultants who do not yet have the appraiser status cannot register themselves as IP appraisers at banking service institutions. It also applies to those who are not certified IPR Consultants but wish to participate in the certification training for assessors of IP guarantee objects, for example, those who previously came from the public appraiser profession.

The profession of assessing the object of IP guarantee can be likened to the profession of the curator in the implementation of bankruptcy and debt payment obligation. Advocates can become curators, but not all lawyers can automatically become curators. Curator and advocate are different legal professions, even though the average curator is an advocate. Accountants (not advocates) can also become curators. The requirement to become a curator is to take part in and pass the curator training held by a curator union organization. This scheme can be applied in IPR. As long as there is no intellectual property professional organization, the provision of this training and certification can be the authority of the Directorate General of Intellectual Property.

## Conclusion

The obligation to fulfill the IPR certificate as an object of guarantee in the future will also encourage the interest of creative business actors to take care of IPR certification. In the future, this institution or profession may not only consist of elements of public appraisal offices/institutions (appraisal profession). Still, it must also involve elements of people who understand the legal characteristics of Intellectual Property as a type of wealth in the form of intangible assets that are different from other assets. In the future, the profession of intellectual property appraiser must be required to have passed the training or certification held by the Directorate General of Intellectual Property.

## References

- [1] Achmad Busro, et al., 2018, "Quo Vadis Copyright as Fiduciary Guarantee in Indonesia Legal Agreement," *Journal of Legal, Ethical and Regulatory Issues*, Vol. 12, Issue 2.
- [2] Angelina Putri Suhartini, Dewa Gde Rudy, 2021, "Hak Cipta sebagai Agunan Kredit Bank", *Jurnal Magister Hukum Udayana*, Vol. 10, Issue 1.
- [3] I Putu Bayu Pramita, et. al., "Analisis Perbandingan Penilaian Jaminan Kredit oleh Penilai Internal dengan Penilai Independen", *Modus Journals*, Vol. 31, Issue 1.
- [4] Nina Nurani, et al., 2014, "Copyright as a Guarantee of Fiducia in the Efforts to Accelerate Indonesia's Creative Economic Growth," *PalArch's Journal of Archeology of Egypt / Egyptology*.
- [5] Putu Eka Trisna Dewi, et al., "Regulation of Copyright Certificate as a Material Guarantee and Bankrupt Estate/Boedel in Indonesia," *ADI Journal on Recent Innovation*, Vol. 2, Issue 2.
- [6] R.F. Najoan, 2016, Kajian Hukum tentang Hak Cipta sebagai Objek Jaminan Fidusia, *Lex et Societatis*, Vol. 4, Issue 7.
- [7] Reni Budi Setianingrum, "Mekanisme Penentuan Nilai Ekonomis dan Pengikatan Hak Cipta sebagai Objek Jaminan Fidusia", *Media Hukum*, Vol. 23, Issue 2.
- [8] Rinitami Njatrijani, et al., 2020, "Business Development of Copyright and Fiduciary Guarantee in Indonesia," *International Journal of Economics and Business Administration*, Vol. VIII, Issue 1.

# Indonesian Slangs in The Digital Communication

Dewi Kusumaningsih<sup>18</sup>

## Introduction

The current digital communication that follows digital society has slowly changed the way people socialize. This phenomenon is prevalent in our daily lives. In the past, relationships were built through direct face-to-face meetings; yet now relationships are built through cyberspace [1]. The way people communicate has also changed following the devices used and their advanced features. Smartphones now connect life as used by the global citizen in cyberspace. Hence, this paper focuses on today's forms of digital communication, which requires different literacy. In Bahasa Indonesia, digital communication has largely caused language changes from formal to non-formal, which eventually leads to the varieties of slang [2]–[4], as a part of language literacy.

Literacy is one's knowledge and skills to obtain and proceed with information to actualize their potential [5]. The Indonesian government has declared six basic literacies, including language literacy, numeracy, scientific literacy, financial literacy, digital literacy, and cultural and civic literacy. These domains are central in the era of society 5.0 as they are needed to correctly proceed with the information flow. Especially, digital literacy is prevalent within the development of society 5.0 [6], [7].

In digital communication, our dependency on gadgets is strongly influenced by various interesting features. These devices are easy to use, practical, and fast. The offered social media have been embedded in our daily lives [8]–[11]. This is why digital literacy is needed by social media users.

Digital literacy is the ability to critically use the information and communication-based (ICT) media in the form of text, audio, images, and videos, before dissemination [12]. It covers one's ability to efficiently use information in various contexts, such as academic, career, or everyday life. There are eight components of digital literacy, namely 1) functional skills and beyond (the skills to accurately employ

---

<sup>18</sup> Universitas Veteran Bangun Nusantara Sukoharjo,  
[dewikusumaningsih71@gmail.com](mailto:dewikusumaningsih71@gmail.com)

the ICT); 2) creativity (utilizing ICT to build knowledge); 3) collaboration (knowledge building through discussion processes in the digital space); 4) communication (the ability to hear, understand, and adapt ideas); 5) selection; 6) critical thinking and evaluation; 7) cultural and social understanding, and 8) e-safety and security) [13].

Digital literacy has grown rapidly through WhatsApp, YouTube, Instagram, Twitter, Google, and so forth. It calls for the users' ability to use information and communication technologies to find, evaluate, create, and communicate information using their cognitive and technical skills [14]. Recently, digital communication in social media applications has shifted Bahasa Indonesia from its standardized rules of writing. It results in the use of inappropriate short vocabulary, emoticons, and the emergence of new terms, and mixed languages. These shifts are commonly referred to as slang. It results from the users' efforts to use contextual vocabulary following the mainstream media. In this case, language shift takes place where Bahasa Indonesia has shifted to the varieties of use with the non-standard language variety.

This paper discusses the use of Indonesian slang in social media. In particular, various findings of vocabulary and forms of slang are described and analyzed. This study employed a qualitative descriptive approach through observation of empirical facts and phenomena witnessed by researchers [15], [16]. All visible phenomena are recorded and detailed as it seeks to reflect the data directly obtained from the object. The data were obtained from various social media platforms through observation and note-taking. The causes of slang were observed whether due to internal or external factors. In this case, internal changes occur from within, which are in the phonological system, morphology, syntax, or other levels. While external changes are caused by outer factors such as borrowing or absorption of other language elements. External changes may also be caused by socio-economic conditions, regional boundaries, age, and gender.

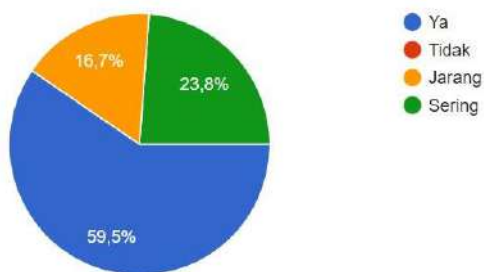
## **Discussion**

Slang is often found in social media, commonly used in daily communication [2] among teenagers and students. Slang is widely used after being popularized by Debby Sahertian through her Slang Dictionary published in 1992. The use of slang is highly increased in this era as suggested by Y.F. Febriyani and colleagues. In her writing about the people of the Kelurahan Medan Tenggara area, new

vocabulary in Bahasa Indonesia was massively used where the existence of formal Bahasa Indonesia is fading. The use of television, radio, newspapers and the internet is certainly a supporting factor in the widespread use of slang [17].

### **Slang among the young generation**

In this study, 42 respondents comprised of students and the general public were approached through Google Form. Results show that 59.5% encountered Slang and used it in their social media; 23.8% often used it, and only 16.7% rarely used it. These numbers showed that Slang has dominated the digital society.



**Figure 1. A pie chart of respondents' results on the use of Slang on social media**

Slang was created as a communication bridge between millennial generations to put away distance or language boundaries when gathering with their friends [18]. In this case, knowledge and the ability to use a new language or term is associated with a person's degree of association in a modern urban community. A person will be considered "uncivilized" if he does not know the meaning of certain terms. Slang emphasizes a shared social identity and a sense of community among its users.

### **Forms of Slang**

Based on the questionnaire results ( $n=42$ ), there is some acquired slang vocabulary in social media.

#### **a. Acronym**

The acronym is an abbreviation in the form of a combination of letters, syllables, or other parts, written and pronounced as natural



words. The found acronyms in digital communication are closely related to today's youth's lifestyle.

**Table 1. Slang Acronyms**

No	Acronyms	Complete words	Meaning	Sentence
1	Bucin	BUDak CINTa	Being in love	"Look at you, <i>bucin!</i> "
2	Japri	JAlur PRIbadi	Direct/private message	"Just <i>japri</i> me later."
3	Nobar	NOnton BAReng	Going to the cinema	"Let's go <i>nobar.</i> "
4	Mantul	MANtap beTUL	Very well	"What you did is <i>mantul!</i> "
5	Pansos	PANjat SOSial	Fighting for social recognition	"She likes to <i>pansos</i> a lot."
6	Mager	MALas GERak	Prefer to stay home	"Don't be so <i>mager!</i> "
7	Gaje	engGAK JElas	Hard to describe	"That man is so <i>gaje.</i> "
8	Kudet	KUrang upDaTE	Outdated	"You're so <i>kudet.</i> "
9	Baper	BAwa PERasaan	Sensitive	"Don't get <i>baper</i> easily,"

b. Abbreviation

The abbreviation is resulted from shortening in the form of letters or a combination of letters. The standard practice of abbreviations is to take the initial letters of words arranged in a particular structure.

**Table 2. Abbreviation**

No	Abbreviation	Complete words	Sentence
1	PAP	Post a picture	"PAP please,"
2	Thx	Thanks	"Thx a lot, Bro!"
3	VC	Video call	"Let's VC, Hun,"
4	GWS	Get well soon	"GWS and see you,"
5	OTW	On the way	"I'm otw,"

It can be seen from the table that abbreviations come from English.

c. Code-mixing

There are code-mixing between Bahasa Indonesia and English in the slang used in digital communication. This occurs because the

speech participants are heterogeneous in some cases, such as based on location, education, gender, or age. These affect the results of code-mixing vocabulary, summarized as follows:

**Table 3. Code-mixing**

No	Code-mixing	Sentence	Notes
1	Mendownload	Kamu sudah mendownload jurnal?	Download is from English added with Indonesian prefix: men-
2	Mengupload	Kamu sudah mengupload tugas?	Upload is from English added with Indonesian prefix: meng-
3	Mengupdate	Eh aku tadi update status baru lo, jangan lupa dilihat ya.	Update is from English added with Indonesian prefix: meng-
4	Direlease	Eh, film baru udah direlease belum ya?	Release is from English added with Indonesian prefix: di-
5	Send	Fotonya sudah aku send ya	Send is from English and is directly integrated into Bahasa Indonesia's sentence
6	Discount	Eh, di matahari lagi ada discount loh, kesana yuk	Discount is from English and is directly integrated into Bahasa Indonesia's sentence
7	Voucher	Setiap pembelian di Garasi Fnb Akan Mendapatkan Voucher	Voucher is from English and is directly integrated into Bahasa Indonesia's sentence
8	Ambyar	Konser itu membuat ambyar penonton	Ambyar is Javanese and is directly integrated into Bahasa Indonesia's sentence
9	Rebahan	Rebahan dulu dong	Rebahan is Javanese and is directly integrated into Bahasa Indonesia's sentence
10	Julid	Emak-emak hobi julid	Julid is spoken slang is directly integrated into Bahasa Indonesia's sentence
11	Ghosting	Hobi kok ghosting to	Ghosting is from English and is directly integrated

12	<i>Alo</i>	Alo gais	into Bahasa Indonesia's sentence Alo is spoken slang is directly integrated into Bahasa Indonesia's sentence
----	------------	----------	---

It can be seen from the table that vocabulary in Bahasa Indonesia is developed through blending. The code-mixing between English and Bahasa Indonesia often takes place by adding the prefix: men-; and the direct use and integration of a full word into another language.

d. Phonological changes

Phonological changes occur in the pattern of vocabulary arrangement associated with changes in language sounds. The observed sound changes include phonetics, shortening of syllables (syllables) at the beginning, middle, and end of words; and reversal.

**Table 5. Phonological change**

No	Phonological change	Sentence	Notes
1	<i>Ngrokok</i>	Kalau <i>ngrokok</i> jangan di sini dong!	The correct word is <i>merokok</i>
2	<i>Udah</i>	Fotonya <i>udah</i> aku <i>send ya</i>	The correct word is <i>sudah</i>
3	<i>Nggak</i>	Aku <i>nggak</i> suka kamu	The correct word is <i>tidak</i>
4	<i>Anjay</i>	Anjay bisa-bisanya aku ditipu	Originally a curse: <i>anjing</i>
5	<i>Santuy</i>	Tenang <i>santuy</i> kawan.	The correct word is <i>santai</i>
6	<i>Ngab</i>	Gimana ini ngab?	Reversed letters from <i>bang</i>
7	<i>Halu</i>	Halu sih jadi orang	Cut from <i>halusinasi</i>
8	<i>Sabi</i>	Sabi banget sih jadi orang	Reversed syllables from <i>bisa</i>
9	<i>Gelay</i>	Gelay banget sih jadi orang	The correct word is <i>geli</i>
10	<i>Gemoy</i>	Gemoy ah suka	The correct word is <i>imut</i>

The table shows that phonological changes are arbitrary.

The aforementioned results show that the massive use of social media affects changes in Bahasa Indonesia. Slang overuse may reduce the users' knowledge of the standard language, and the use of proper spelling. Results of this study show that the new vocabulary adapted to the trend of youths' needs and lifestyles, which lead to the acronyms, abbreviations, code-mixing, and even phonological changes. The emergence of new words in slang language is influenced by the users' education and residency. For example, rural people are considered outdated if he does not know the meaning of certain terms. This is because they are less exposed to language development [18].

Slang is often found in social media as a sign of digital literacy [19]. It is among the keys in facing technological developments [20]. In this case, Society 5.0 calls for agile, responsive people with outstanding computing skills, big data, technology. These skills are central to today's networking, yet resulted in the evolution of language use.

## Conclusion

The good use of Bahasa Indonesia has undergone multiple changes, especially as the language in digital communication. Slang has emerged as the common language used, which are resulted from various elements. Often, standardized Bahasa Indonesia does not apply in social media. This phenomenon is acceptable as long as the users are aware and understanding about the use of formal Bahasa Indonesia.

## References

- [1] Maria Ulfa Batoebara, "Inovasi dan kolaborasi dalam era komunikasi digital," *J. Pros. Ilmu Sos. dan Ilm Polit. Univ. Darmawangsa*, pp. 29-38, 2021.
- [2] Y. F. Febrianti, R. Pulungan, P. Bahasa, S. Indonesia, and U. M. Al-Washliyah, "Penggunaan bahasa gaul terhadap eksistensi bahasa Indonesia pada masyarakat," *jurnal-lp2m.umnaw.ac.id*, vol. 2, no. 1, 2021, Accessed: Jan. 12, 2022. [Online]. Available: <https://jurnal-lp2m.umnaw.ac.id/index.php/JIP/article/view/752>.
- [3] G. Goziyah, M. Y.-S. N. P. Bahasa, and U. 2019, "Bahasa gaul (prokem) generasi milenial dalam media sosial," *ejournal.unib.ac.id*, Accessed: Jan. 12, 2022. [Online]. Available: <https://ejournal.unib.ac.id/index.php/semiba/article/view/10285>.

- [4] M. Ridlo, Y. Satriyadi, and N. Azzahra, "Analisis pengaruh bahasa gaul di kalangan mahasiswa terhadap bahasa indonesia di zaman sekarang," *J. Kewarganegaraan*, vol. 5, no. 2, 2021, doi: 10.31316/jk.v5i2.1940.
- [5] K. Queena Fredlina, K. T. Werthi, H. W. Astuti, S. Primakara, U. S. Bumi, and R. Jurai, "Pelatihan Literasi Digital sebagai Penunjang Pembelajaran Daring pada Karang Taruna Desa Mekarsari Cileungsi Bogor, Jawa Barat," *jurnal.lp3mkil.or.id*, vol. 2, no. 2, 2021, Accessed: Jan. 12, 2022. [Online]. Available: <https://jurnal.lp3mkil.or.id/index.php/bnl/article/view/126>.
- [6] M. I. Kahar, H. Cika, Nur Afni, and Nur Eka Wahyuningsih, "Pendidikan era revolusi industri 4.0 menuju era society 5.0 di masa pandemi covid 19," *Moderasi J. Stud. Ilmu Pengetah. Sos.*, vol. 2, no. 1, pp. 58–78, Sep. 2021, doi: 10.24239/MODERASI.VOL2.ISS1.40.
- [7] A. I. Santos and S. Serpa, "Literacy: promoting sustainability in a digital society," *J. Educ. Teach. Soc. Stud.*, vol. 2, no. 1, p. p1, Jan. 2020, doi: 10.22158/JETSS.V2N1P1.
- [8] Karsoni Berta Diana, "Literasi digital dalam pembelajaran daring," *jurnal.umko.ac.id*, Accessed: Jan. 12, 2022. [Online]. Available: <https://jurnal.umko.ac.id/index.php/eksponen/article/view/368>.
- [9] R. Romadhianti, Y. Wulandari, and R. D. Kartika Sari, "Analisis pengaruh bahasa gaul di kalangan mahasiswa terhadap bahasa indonesia di zaman sekarang," *J. Pendidik. dan Pengajaran*, vol. 54, no. 2, p. 297, Jul. 2021, doi: 10.23887/JPP.V54I2.31849.
- [10] F. Nastiti and A. Abdu, "Kajian: Kesiapan Pendidikan Indonesia Menghadapi Era Society 5.0," *Edcomtech J. Kaji. Teknol. Pendidik.*, vol. 5, no. 1, 2020, doi: 10.17977/um039v5i12020p061.
- [11] M. Sururuddin and Dkk, "Strategi Pendidik Dengan Media Pembelajaran Berbasis Multimedia Untuk Menghadapi Era Society 5.0," *J. DIDIKA Wahana Ilm. Pendidik. Dasar*, vol. 7, no. 1, 2021.
- [12] O. A. K. Shavab, "Literasi digital melalui pemanfaatan media pembelajaran edmodo pada pembelajaran sejarah," *Sej. dan Budaya J. Sejarah, Budaya, dan Pengajarannya*, vol. 14, no. 2, p. 142, Dec. 2020, doi: 10.17977/UM020V14I22020P142-152.
- [13] K. B. Dinata, "Analisis kemampuan literasi digital mahasiswa," *J. Pendidik.*, vol. 19, no. 1, pp. 105–119, 2021, doi: 10.31571/edukasi.v19i1.
- [14] R. Agustini and M. Sucihati, "Penguatan Pendidikan Karakter

- melalui Literasi Digital sebagai Strategi menuju Era Society 5.0,” *Pros. Semin. Nas. Pendidik. Progr. Pascasarj. Univ. PGRI Palembang*, 2020.
- [15] J. W. Creswell and J. D. Creswell, *Research design qualitative, quantitative, and mixed methods approach the fifth edition*. Los Angeles, USA: SAGE Publications, Inc., 2018.
- [16] Muri Yusuf, *Metode penelitian kuantitatif, kualitatif, dan penelitian gabungan*, 4th ed. Jakarta: Kencana, 2017.
- [17] Y. F. Febrianti and R. Pulungan, “Penggunaan Bahasa Gaul Terhadap Eksistensi Bahasa,” *Univ. Muslim Al-washliyah*, vol. 2, no. 1, p. 45, 2021.
- [18] G. Y. Goziah, “Bahasa Gaul (Prokem) Generasi Milenial dalam Media Sosial,” *Semin. Nas. Pendidik. Bhs. dan Sastra*, no. December, pp. 120–125, 2019.
- [19] K. B. Dinata, “Analisis Kemampuan Literasi Digital Mahasiswa,” *Edukasi J. Pendidik.*, vol. 19, no. 1, pp. 105–119, 2021, doi: 10.31571/edukasi.v19i1.
- [20] K. Q. Fredlina, K. T. Werthi, and H. W. Astuti, “Literasi Digital Bagi Pendidik Indonesia Dan Implementasinya Dalam Proses Pembelajaran Pasca Pandemi,” *J. Abdi Masy. Saburai*, vol. 2, no. 2, pp. 108–114, 2021, doi: 10.24967/jams.v2i2.1359.

# Students' Spatial Reasoning in Solving the Flat Shapes Problem

Dewi Risalah<sup>19</sup>

## Introduction

Spatial reasoning is the processing of nonverbal information in the form of images or symbols to solve problems [8]. According to [5], states that spatial thinking or reasoning, mentally or physically involves ourselves, the location and movement of objects.

Spatial reasoning is very important in informing our ability to investigate and solve problems, especially problems in mathematics [8]. States that spatial reasoning is not only important in mathematics but also in all fields of study [4]. The Ontario curriculum combines spatial sense and geometry into a single unit because they are related as a whole. In line with the curriculum [6] states the importance of spatial reasoning skills in STEAM, geometry, measurement and problem solving both inside and outside school.

Geometry is one of the materials in mathematics that has been taught to students in Junior High School. Geometry is the study of shapes and images. Without spatial abilities, students cannot fully appreciate nature [2]. In geometry students are required to be able to imagine, manipulate and compare an object in solving problems. For example, if students are asked to find the shaded comparison area of a shape, then what students can do is imagine and manipulate the shape of the shape as one way to solve it [8].

In the problem solving process, a person will carry out a mental process by using all the knowledge he has and determining the right strategy to solve the problem. Reveals two kinds of problems, namely (a) problems to find, can be theoretical or practical, abstract or concrete including puzzles, and (b) problems to prove, to show that a statement is true or false (not both) [7]. In mathematics, problems are usually in the form of math problems, but not all math problems are problems. Explains that a question or problem is called a problem depending on the knowledge a person has. So a question or problem is a problem for someone but may not be a problem for someone else [3].

---

<sup>19</sup> IKIP PGRI Pontianak

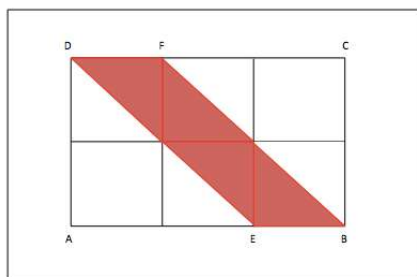
Based on the background of the problem above, the formulation of the problem in this paper is "How is the student's spatial reasoning in solving mathematical problems?" By knowing this spatial reasoning, it is hoped that it can provide ideas to educators in improving mathematics learning, especially flat shapes by paying attention to students' spatial reasoning

## Research Results and Discussion

### Research result

At the time of data collection, all subjects were given assignments in the form of questions related to spatial reasoning, where students were asked to determine the ratio of the shaded area to the overall shape. After that, students who have spatial reasoning enter the interview session. Students who have spatial reasoning are students who are able to solve problems by imagining, manipulating and comparing an object.

The questions given to the students are as follows:  
(Students are asked to determine the ratio of the shaded area to the overall shape)



**Figure 1. Problems [8]**

On the wall is affixed a rectangular ceramic tile consisting of unit squares. Some ceramics are painted in different colors. Determine the ratio of the area of the painted area to the total area of the rectangle!

After the students did the task, then the researcher checked their work and conducted interviews with several students, it turned out that there were variations in the answers which were concluded as follows:

On the problem 1:

1. Student A answers by imagining first by saying "I imagine the object", then after that manipulates the object by saying "I see the

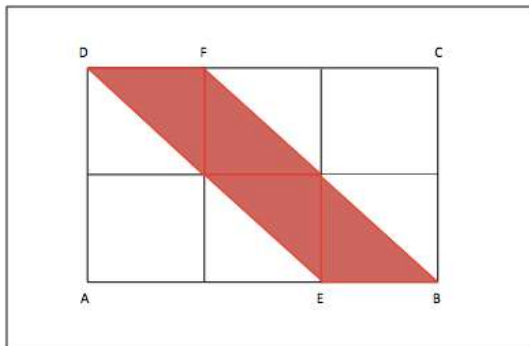


- object" and compares existing objects as a way of solving the given problem.
2. Student B answered by manipulating the object by looking at the same shape and then comparing it with the overall shape.

Based on some of the student's answers above, students can solve mathematical problems when they have spatial reasoning which includes imagining, manipulating and comparing objects. From the problems given above, there are also students who solve geometrical problems in an analytical way.

**Research Discussion**


Based on the results of the research above, students who have spatial reasoning are students who are able to imagine, manipulate and compare an object. This is in line with [1] which states that the category of spatial reasoning includes mental transformation (mentally manipulated) and mental rotation (imagine), while for students who do not use spatial, they answer in an analytical way. As an example in the Problem above:



**Figure 2. Problems given [8]**

In Figure 2, when students solve the problem by focusing on the shaded area by imagining and manipulating objects, it can be said that the student sees elements that are close together which are seen as a certain perfect and simple form.

Desired answer according to spatial reasoning:

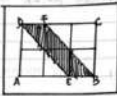


Diketahui : persegi panjang ABCD : 6 satuan persegi  
 keramik DFBE dicat dengan warna berbeda  
 Ditanya : perbandingan luas daerah yang dicat terhadap luas keseluruhan persegi panjang ABCD ?  
 Penyelesaian :

1. Ukur luas persegi panjang ABCD ada 6 satuan persegi
2. Ukur luas daerah yang dicat keramik menjadi jika dijumlahkan
3. Jadi perbandingan luas daerah yang dicat terhadap luas keseluruhan persegi panjang ABCD adalah 2 : 6 atau 1 : 3.

**Figure 3. Snippets of Student Answers who answered in a Spatial Way**

Another answer that doesn't use spatial reasoning but analytic

Jawaban :  


Pada dinding ditempel sebuah keping keramik berbentuk persegi ABCD yang berwujud atas persegi-persegi satuan. Sebagian keramik DFBE dicat dengan warna yang berbeda. Tentukan perbandingan luas daerah yang dicat terhadap luas keseluruhan persegi panjang ABCD :

Penyelesaian :  
 perbandingan luas persegi p ABCD : D#BE  
 persegi panjang ABCD memiliki 6 persegi  
 1 persegi dengan luas =  $5 \times 5$   
 $= 5^2 \times 4$   
 $= 6 \text{ s}^2$  (luas persegi)

Daerah DFBE = dicat dengan dan 1 keramik  
 $= \frac{1}{3} \cdot 6$   
 $= 2$  (persegi)  
 $= 2$  (persegi)  
 $= 2 \text{ s}^2$   
 $2 \text{ s}^2 = 6 \text{ s}^2$   
 $1 : 3$

**Figure 4. Snippets of student answers who answer in an analytical way.**

### Conclusion

Based on the description above, it can be stated that spatial reasoning plays an important role in solving mathematical problems. The component of spatial reasoning seen in this study is the ability of students to imagine, manipulate and compare objects in order to solve the problem of flat shapes.

### References

[1] Chang, D. & Nesbitt, K. 2005. Developing Gestalt-Based Design Guidelines For Multy Sensory Display. The Proceeding Of NICTA-Hcsnet Multimodal User Interaction Workshop, The ACS

- Conference In Research And Practice In Information Tecnology CIRPIT, 57: 9-16.
- [2] Guven, B ; Kosa, T. (2008). The Effect Of Dynamic Geometry Software On Student Mathematics Teachers Spatial Visualization Skill. The Turkish Online Journal of Education Technology. ISSN : 1303-6521 artichel 11 , 7 (4).
  - [3] Hudojo, Herman. (2003). Pengembangan Kurikulum dan pembelajaran matematika. Malang: Universitas Negeri Malang
  - [4] National Council of Teacher Of Mathematics. (2006). Curriculum Focal Points For Prekindergarten Through Grade 8 Mathematics (A Quest For Coherence, Reston VA: Autor ed.).
  - [5] National Research Council. (2006). Paying Attention to Spasial reasoning (Support Document for Paying Attention to Mathematics Education). (K.-1. N. Press., Ed.) Washington, DC.
  - [6] Ontario Ministry Of Education. (2007). The Ontario Curriculum: Grade 11 dan 12. (ON: Queen's Printer for Ontario ed.).Toronto: [http://www.edu.gov.on.ca/eng/curriculum/secondary/math\\_112\\_currb.pdf](http://www.edu.gov.on.ca/eng/curriculum/secondary/math_112_currb.pdf).
  - [7] Polya. (2004). How to Solve It : A New Aspect of Mathematical Method. Princenton, New Jersay: Princenton University Press.
  - [8] Risalah, D; Nusantara, T; Sutawidjaja, A & Susiswo. (2019). Spatial Reasoning Based on the Tendency of Gestalt Law to Solve Geometry Problems. Universal Journal of Educational Research 7(12): 2742-2746, 2019. DOI: 10.13189/ujer.2019.071223.

# **Industrial Revolution 4.0 and Society 5.0 Eras: From the Strategic Human Resource Management's Perspective**

Dianawati Suryaningtyas<sup>20</sup>

## **Introduction**

The evolution of Information and Communications Technology (ICT) is delivering significant changes to society as well as industry. At present, the globalization and rapid evolution of digital technologies such as the Internet of Things (IoT), Artificial Intelligence (AI), robotics, 3D printing and data analytic are delivering significant changes to society. Digital transformation has becoming a new life style in society and a pillar of industrial policy. The Society 5.0 era has emerged which initiated by the Japanese government to bring human resource a balance caused by industrial revolution 4.0. The definition of society 5.0 is the concept of building society on human-centered by balancing economic progress with social problems solving using a system that is highly connected through cyberspace and the real world [1]. The emergence of Society 5.0 follows existence of industrial revolution 4.0 that shocked business world. It seems that society 5.0 as a response to the most workers worry about their positions replaced by the implementation of digital technology in organization.

Society 5.0 give implication in all aspects of life from health, life style, education, transportation, agriculture, and industry. The aim of society 5.0 is to create a society in which people enjoy life by utilizing technological developments to balance economic growth and social problems that emerge [2]. Previously, there are different stages of societies. Society 1.0 is defined as groups of people pursuing and gathering in harmonious coexistence with nature; Society 2.0 formed groups based on agricultural cultivation, improving organization and nation-building; Society 3.0 is a society that promotes industrialization through industrial revolution, making mass production possible; and Society 4.0 is an information society that realizes increased added-value by connecting intangible assets as information networks. The last evolution, Society 5.0 is an information society establish caused by the impact of industrial revolution 4.0, purposing for a prosperous human-centered society [3]. Society 5.0

---

<sup>20</sup> Universitas PGRI Kanjuruhan Malang

has a big data technology collected by Internet of things (IoT) [4] changed by Artificial Intelligence (AI) [5]; [6] into something that can help people that make their life becomes better. It is important to understand the goal of Society 5.0, that is to create a human-centric society, as the resolution of both economic growth and societal problems are accomplished, so that people can enjoy a high quality of life that is fully active and comfortable [3].

The industrial revolution 4.0 delivers challenges in business world due to changing of operational business that shift from traditional into digital technology. The implementation of industrial revolution 4.0 emerge disruption in many areas of organization. Disruption has an impact on the lack of human resource skills with the emergence of new types of work related to the use of digital technology. In the society 5.0 era, technological advancement forces change in society and organizational culture. Organizations that successfully handle various transformational changes can continue to evolve and adapt along with technological changes. [7]. The role of strategic human resource management to execute the transformation changes of the organization in order to handle disruption, make survive and reach competitive advantage.

The development of human resource management focus on the strategic roles that build organization to reach competitive advantage. To build sustainable competitive advantage, it is determined by how the company establishes a strategic orientation are principles that direct and influence company activities and build behaviors that are directed to ensure business success and performance [8]. The perspective of strategic human resource management to face the changes of industrial revolution 4.0 and society 5.0 can be seen through the use of strategic tools such as innovation, change management, talent management, and so forth.

Change management usually in relation to people factor because innovative and agile workplaces replace the stable era of pre-information bureaucracy, and change management becomes an important part of every introduction of new technology [9]. Organizational change can be driven by the implementation of information technology system [10]. The application of new technology becomes a challenge for organization to execute organizational change as a part of successful innovation. The necessary of change management to the successful implementation of new information technology is recognized [11]. To gain success in executing change management, it is needed the charismatic

transformational leader with excellent competencies, experience, intellectual skills, and interpersonal communication skills among employees and organizational leaders [12] to drive and lead the changes.

To reach sustainability and competitive advantage of companies depend mostly on their capability of adaptation to changing business requirements. Driving from the advancements in new digital technologies known collectively as industrial revolution 4.0, has been deeply changing dynamics of most industries. Digitalization of business processes together with emergence of digital business models impose new digital skill requirements for workforce. Creating future workforce involves not only attracting and developing new talent needed, but also re-skilling current employees through training programs as well as re-designing work processes for reducing the skill mismatch between jobs and employees [13]. Talent management, which has been identified as one of the most important human resource functions [14], as a strategic initiative to develop talent to meet and match with new requirements for workforce.

## **Discussion**

The adoption of industrial revolution 4.0 is considered the biggest technological revolution with computerization in production and many areas of industries. The use of new technology causes energy and cost reduction, increased quality, safety and improvement of production processes. It pursues the creation of new opportunities for industries, with the challenge of automation and digitalization of production processes, a dynamic of manufacturing and supply. Society 5.0 is moving from the manual work towards the digital machines, and the worker would become the knowledge worker. To operate the machines require far fewer workers. The problem is for society 5.0 not to absorb this human factor. It is the responsibility of human resource to provide knowledge worker with new skills to operate digital machines used as the result of innovation adoption and change management that have been implemented in organization. The perspective of strategic human resource management to help organization adapt and enter industry 4.0 as well as society 5.0, there several strategic tools of human resource to response in these issues, so that organizations can transform themselves into new era of industrial digitalization.

## **Response of Strategic Human Resource Management**

Human resource professionals choose strategic tools of innovation in response to the coming era of industrial revolution 4.0, then followed by society 5.0. Innovation strategy will only be implemented when organization do change management. The ability of an organization to adapt to external environmental changes and be innovative is reflected in the organization's ability to deal with various changes. The attitude of society towards new technology is important and it becomes a question whether this attitude of society hinders the application of innovative technology. While innovation adoption of information technology, assumes that the adopters make full use of the innovation [15]. According to [16], innovation in the workplace is influenced by three factors, such as environmental problems, barriers, and leadership skills. Barrier mindset can be a challenge of innovation that requires organizational environment and leadership behavior that support creating organizational culture. Leadership must support and encourage innovation in order to appreciate employee innovation [16].

Change management refers to the methods and manners in which a company describes and implements change within both its internal and external processes. Organizations cannot avoid changes, unless to take a risk difficulty to survive in the turbulent and uncertainty conditions influenced by external environment. The successful implementation of business operations and the concept of information technology is more determined by change management has been proven [11]. Human resource professionals conduct change management and must ensure that the leader of organization who lead change management must have the capacity of transformational leadership. There are three different types of change management, namely, developmental, transitional, and transformational. It is important to recognize this as the different kinds of change require different strategies and plans to gain engagement, reduce resistance, and ease acceptance. And the transformational leader must understand and choose the appropriate initiative strategy to the need of organization to change.

Transformation leadership is needed in turbulent and uncertain environment. The important leadership in change management need a new system and new approach. Besides the capability to lead the management changes to adapt to new digital technology, leadership and behavior of the leader give significant impact on the awareness of employees' behavior. Transformational leadership is a way to influence employees' motivation and behavior

during change [17], which has been shown to affect employees' attitudes towards and readiness to change positively [18] and to reduce their resistance about change [19]. Transformational leaders through their charismatic nature and ability to create a positive vision of change that is worth interest and inspire their followers. A few studies have found that transformational leadership influences employee behavior during change by improving performance [20] and increasing behavioral support of a change [21].

The importance of talent management practices is that talented employees have the strategic capabilities that can increase the productivity, efficiency and competitive advantage of organizations in various industries [22]. However, talent development should be positioned as a strategic level, so as to the identification of strategic competencies that characterize 'who the talented employees are' should be link and match with requirements of new capabilities of workforce derived from industry 4.0. This talent development also need to be aligned with corporate strategy and all strategic business processes. In the era of industrial revolution of 4.0 and society 5.0, organization needs to focus on preparing talent with high capabilities to meet the requirements of business and industries. Refer to [23] concept of talent, that is: "Talent = competence [knowledge, skills and values required for today's' and tomorrows' job; right skills, right place, right job, right time] commitment [willing to do the job] contribution [finding meaning and purpose in their job]" (p. 60).

This means that human resource professionals to develop talent with new competencies not only for today' need but also for tomorrow' job. Besides, talent management practices enable organization to utilize, develop, and manage talented employees as well as retaining and rewarding. In Industry 4.0 era, employees need to have a collection of ICT skills. And more important skills for successful execution of hard-skills of digital technology, employees also should have soft-skills such as collaboration, communication, teamwork, adaptability and flexibility, so that high performance can be achieved. And this is very important in gaining competitive advantage of the organization.

## **Conclusion**

The Industrial Revolution 4.0 and Society 5.0 eras deliver the biggest impact to business and organizations in today's' business competition. From the perspective of strategic human resource



management, organizations should response to these eras with strategic tools such as innovation, change management, transformational leadership, and talent management to the emergence of new digitalization technology in all aspect of business. The roles of human resource professionals to overcome these environmental changes with strategic choices and initiatives so that organization can adapt to the new digital technology and ready with the new competencies of potential talent in which it can link and match with the requirements of new workforce. When all of these can be executed successfully, it is not possible for organization to gain sustainable competitive advantage. Indeed, in terms of organization, the goals of society 5.0 in giving balance between economic development and workforce problems solving that arise as a result of industry 4.0 can be achieved.

## References

- [1] P. Skobelev, And Y. S. Borovik. 2017. On The Way From Industri 4.0 To Industri 5.0: From Digital Manufacturing to Digital Society. *International Scientific Research Journal*: 307- 311.
- [2] D. Hendarsyah, 2019. E-Commerce Di Era Industri 4.0 Dan Society 5.0. *IQTISHADUNA: Jurnal Ilmiah Ekonomi Kita* 8(2): 171-184.
- [3] M. Fukuyama 2018. Japan SPOTLIGHT • July / August 2018, <https://www.jef.or.jp/journal/>
- [4] H. S. Hayashi, 2017. International Standardization for Smarter Society in the Field of Measurement, Control And Automation. 56th Annual Conference of the Society of Instrument And Control Eng.
- [5] N. I. Rokhmah, (2019). Peran Matematikawan Dalam Era Revolusi Industri 4.0 Teknologi Yang Relevan Menjadi Bagian Integral Dari Kurikulum. Peran Matematikawan Dalam Era Revolusi Industri 4.0. Teknologi Yang Relevan Menjadi Bagian Integral Dari Kurikulum.
- [6] V. Özdemir, &. (2018). Birth Of Industry 5.0: Making Sense Of Big Data With Artificial Intelligence, "The Internet Of Things" And Next-Generation Technology Policy. *Omics: A Journal Of Integrative Biology* 22(1) , 65-76.
- [7] J.E. Agolla, & Van Lill, J.B. 2017. A Structural Equation Modeling of Innovation in Public Sector Organizations. *African Journal of Business and Economic Research*, 12(1): 107-140.
- [8] L. E.Puspita, , Christiananta, B., & Ellitan, L. (2020). The effect of

- strategic orientation, supply chain capability, innovation capability, on competitive advantage and performance of furniture retailers. *International Journal of Scientific & Technology Research*, 9(03), 4521-4529
- [9] S.L. Jones, & Van de Ven, A.H. 2016. The Changing Nature of Change Resistance: An Examination of the Moderating Impact of Time. *The Journal of Applied Behavioral Science*, 52(4): 482-506
- [10] T.R. Gouker, 2009. Information technology-enabled change management: An investigation of Individual experiences. Walden University. Retrieved from ProQuest Dissertations and Theses
- [11] Sutanto, J., Kankanhalli, A., Tay, J., Raman, K.S., & Tan, B.Y 2008. Change Management in Interorganizational Systems for the Public. *Journal of Management Information Systems*, 25 (3): 133-175
- [12] Ghiorghita, E., & Grzegorzcyk, A. 2017. Knowledge Management as a Strategic Business Resource. *Journal of Economic Development, Environment and People*, 6(2): 63-72
- [13] G. Karacay (&) Department of Industrial Engineering, Faculty of Management, Istanbul Technical University, 34367 Maçka, Istanbul, Turkey e-mail: [karacayaydin@itu.edu.tr](mailto:karacayaydin@itu.edu.tr). 2018
- [14] R. Strack, (2014). *Creating people advantage: How to set up great HR functions: Connect, prioritize, impact*. Boston, MA: Boston Consulting Group (BCG).
- [15] Carlo, J. L., Lyytinen, K., & Rose, G. M. (2012). A knowledge-based model of radical innovation in small software firms. *MIS Quarterly*, 36(3), 865–A810. Retrieved from <https://www.jstor.org/stable/pdf/41703484.pdf>.
- [16] M., Moussa, McMurray, A., & Muenjohn, N. 2018. A Conceptual Framework of the Factors Influencing Innovation in Public Sector Organizations. *The Journal of Developing Areas*, 52(3): 231-240
- [17] S. Oreg, & Berson, Y. (2011). Leadership and employees' reactions to change: The role of leaders' personal attributes and transformational leadership style. *Personnel Psychology*, 64(3), 627–659.
- [18] D., Herrmann, Felfe, J., & Hardt, J. (2012). Transformationale führung und veränderungsbereitschaft. *Zeitschrift für Arbeits- und Organisationspsychologie*, 56(2), 70–86.
- [19] K. A., DeCelles, Tesluk, P. E., & Taxman, F. S. (2013). A field investigation of multilevel cynicism toward change. *Organization Science*, 24(1), 154–171.
- [20] M., Carter, Armenakis, A., Field, H., & Mossholder, K. (2013).

- Transformational leadership, relationship quality, and employee performance during continuous incremental organizational change. *Journal of Organizational Behavior*, 34(7), 942–958
- [21] P. Chou, (2015). Transformational leadership and employee's behavioral support for organizational change. *Journal of Management and Administrative Sciences Review*, 3(3), 825–838.
- [22] S, Khilji Tarique I, Schuler R (2015) Incorporating the macro view in global talent management. *Hum Resource Manag Rev*:236–248
- [23] Ulrich D, Smallwood N (2012) What is talent? *Leader to Leader* 63:55–61

# The Online Learning Resources in Mastering Listening Comprehension: Students' and Teachers' Perspectives

Dodi Mulyadi<sup>21</sup>

## Introduction

The internet is widely used in daily life, including education. Internet technology enables students to maximize their learning potential by providing a flexible, practical, and multifaceted online education platform. Utilizing the internet in education can be accentuated in the use of myriad online learning resources. Online learning resources in English language learning have simplified the process of acquiring English language competency by tailoring this technology to individual needs [1].

Using online learning resources to support students' interaction and knowledge production and encouraging collaborative learner autonomy has been shown to be beneficial [2]. English as Foreign Language (EFL) instruction is no exception in society 5.0, and the influence of the covid 19 pandemic, the concept of learning EFL through the internet has become the primary mode of instruction. Online learning resources using the internet have become an inseparable part of the successful learning process either inside or outside the classroom. It has long been understood that the internet, computers, and mobile devices should assist students with their EFL learning [3].

Listening ability is a necessary skill when studying EFL. Despite the fact that listening is generally viewed as a passive skill, listening takes a significant role in everyday conversation [4]. However, English teachers and instructors sometimes disregard listening instruction. While listening comprehension has a substantial impact on an individual ability to communicate successfully. Numerous previous studies have analysed listening, but only a few have explored resources for encouraging autonomous listening classroom instruction suited to learners' preferences.

Students' preferences for online listening resources can assist them in gaining more autonomy in their English learning materials

---

<sup>21</sup>Universitas Muhammadiyah Semarang, [dodi@unimus.ac.id](mailto:dodi@unimus.ac.id)

both in and out of class. Several studies have been undertaken to ascertain students' perceptions or experiences with listening learning resources [5], [6]. However, research exploring students' and instructors' perceptions of enhanced autonomy in listening learning is comparatively scarce. Thus, I investigated the relationship between the concept of autonomy in listening learning and online learning resources from the perspectives of both students and instructors in this study.

The following are the two primary research questions investigated in this study.

1. How do EFL learners perceive online learning resources in mastering listening comprehension in an online learning context?
2. How do EFL teachers perceive online learning resources in mastering listening comprehension in an online learning context?

### **Research design and Instruments**

This study taking place between September and November 2021 employed a mixed-methods approach, distributing a questionnaire and conducting a semi-structured interview. A questionnaire was administered using an open-ended question about EFL learners' experiences in utilizing online learning resources in mastering and developing their listening abilities. Furthermore, semi-structured interviews were gathered to elicit more detailed information and ascertain the rationale for selecting learning resources. Subsequently, two experts validated this interview protocol before administering them to participants.

### **Research procedure**

The questionnaire was piloted with 15 English language students and two EFL teachers at a private university in Semarang. It was undertaken to ascertain the data's validity and reliability. The content and improvements in the use of linguistics, resources, and trends in listening instruction were validated through expert validation. Two senior academics evaluated the content validity of blended learning practices by evaluating all categories and indicators, followed by the reliability, which was determined to be between 0.84 and 0.96. As a result, the questionnaire has been determined to be valid and reliable.

All participants completed questionnaires, ensuring that all data would be kept private and used strictly for the objectives of this study. The questionnaire was designed online using Microsoft Forms

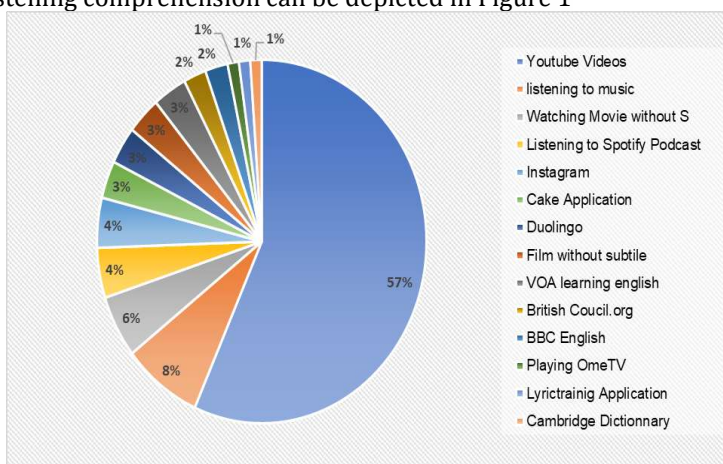
and was supposed to take approximately 15 to 20 minutes to complete. Two weeks were given to participants to complete the survey thoroughly.

As a follow-up to the questionnaire results, semi-structured interviews were conducted to ascertain the difficulties or obstacles EFL students and EFL teachers experienced in using online learning resources. To wit, they assessed the scope and quality of their perspectives due to their listening experiences. The interviews were recorded and then transcribed verbatim for analysis.

## Results

### ***Q1: How do EFL learners perceive online learning resources in mastering listening?***

Results of an open-ended survey from EFL learners' perspectives toward the utilization of online learning resources in enhancing their listening comprehension can be depicted in Figure 1



**Figure 1. EFL Learners' Experiences in Using Online learning resources in Mastering Listening Comprehension**

According to Figure 1, EFL students were more likely to use YouTube as a language learning resource than other resources. They consumed YouTube at a rate of more than 50% mastering English, especially in mastering listening skill. This finding is verified by the interview results included in the following extracts, with E referring to the interview excerpt and T to the EFL teacher and L to EFL learners.

E1 : *"I frequently learn from YouTube because it makes the process of learning English much more enjoyable, and for me, learning to use videos helps me comprehend the content more quickly."* (L3).

This finding aligns with the previous study that YouTube videos as learning materials are rising due to a content-based instructional (CBI) approach to English language teaching (ELT). Additionally, YouTube provides authentic learning, enriching the student learning experience and preparing graduates for future jobs [5]. To succeed in English as a second language (EFL), students must access authentic resources and a supportive learning environment [7].

Furthermore, this data demonstrates that students in English classes use a variety of tools to improve their listening skills. EFL learners master English, particularly listening comprehension, by frequently involving the usage of applications related to listening to music, which account for approximately 8% of the total. In addition, another Source, Films without subtitles, were deemed as favourite online English media or resources in enhancing their listening abilities. The use of movies as language learning materials emphasized the importance of establishing techniques for informal settings, particularly mobile settings, for ELT majors who are lifelong learners [6].

Interestingly, four students from 90 students in the study choose to enhance their listening abilities by listening to Spotify podcasts. To wit, listening to podcasts can assist students in developing a more self-sufficient ability for English learning [8]. Podcasts are a teaching medium that can boost knowledge and motivation in listening mastery among students with poor English language abilities [9].

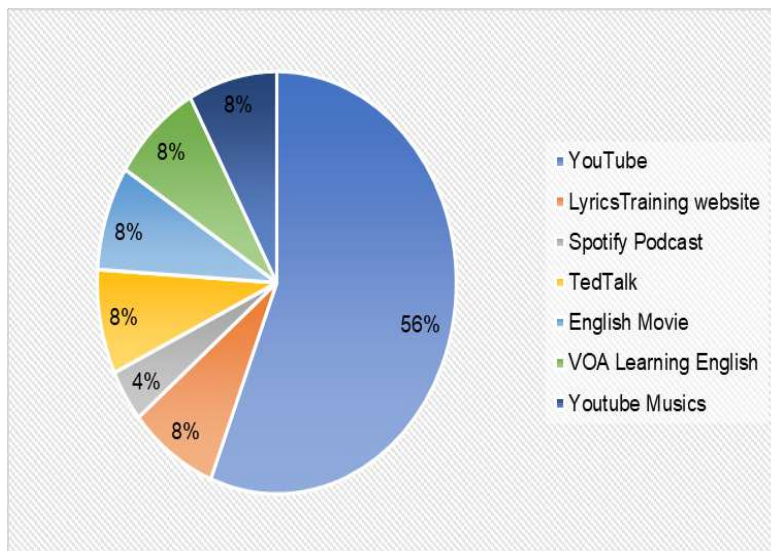
Some applications can be installed on Android or viewed on Windows, such as Duolingo cake applications and lyrical training applications. However, its usage occurs only in part or at a very low rate. Only 1% of people use the OmeTV program for mastering listening comprehension and utilize the Cambridge dictionary. When learners are learning a new language, it is essential that they listen to the target language in context rather than as isolated words or sentences.

To sum up, these findings, it can be inferred that YouTube is a prevalent educational resource for EFL students. Students are

more likely to use YouTube to improve their listening skills than other applications. Therefore, EFL teachers need to develop their capabilities in the use of technologies to produce instructional videos that can be published on YouTube. Additionally, teachers should promote listening material in the form of learning to listen to music and podcasts that can be obtained via Spotify or YouTube music. As a result, students can engage in additional learning activities aimed at increasing their listening comprehension.

**RQ 2: How do EFL teachers perceive online learning resources in mastering listening skills?**

Figure 2 illustrates EFL teachers' experiences in utilizing online learning resources in teaching listening class.



**Figure 2. EFL Teachers' Experiences in Using Online learning resources in Teaching Listening Class**

Meanwhile, the teacher's perspective on selecting learning resources in mastering listening comprehension can be seen in Figure 2. It shows that the teacher's point of reference when it comes to teaching listening class. Interestingly, EFL teachers' perspectives of listening learning resources showed that YouTube contributes to the successful learning resources in mastering listening class. This



finding is relatively similar to the students' responses, where 56% of teachers believe that YouTube is a favourite learning resource for teaching listening. The interview results of the EFL teachers support this data, as can be seen in Excerpt 2.

E2: *"I think learning English through YouTube has a huge impact on Listening skill since students can receive material in the form of audio-visual and motion pictures, which enables them to grasp the material more quickly, practically, and enjoyable". (T1).*

Additionally, it shows their understanding of the benefits of using interactive strategies to acquire content and improve pronunciation [10]. YouTube is regarded as a learning resource that may provide authentic listening comprehension materials since it enables students to develop their language abilities through observation of many variations in communication practice [11]. Nevertheless, there are certain drawbacks to using YouTube to find instructional information. Teachers need to devote more time to previewing and selecting language and context films appropriate for classroom use and preparing exercises for their students based on the videos [5].

However, when the number of variations in learning resources is considered, it becomes clear that there is a minimal variation from the teacher's perspective. The teacher utilizes lyrics training, which is also popular among teachers due to the program's apparent effectiveness and utility in boosting listening abilities. It is a strong possibility, as children benefit from listening to music while they learn. Additionally, with lyric training, pupils can be assigned songs that are both popular and enjoyable. This finding is corroborated with the result of the interview in Excerpt 3.

E3 : *"Listening to music from anywhere and watching movies makes the learning atmosphere interesting and fun and easier to my learners" (T2)*

Nowadays, many people, especially those who grew up with smartphones, seem to like listening to music. These findings suggest that songs can be utilized to teach English multi-word units or expressions. From an ELT standpoint, songs have the ability to reach a diverse audience [12]. The previous research shows that the group taught through listening to music outperformed the control group in memory [12].

Additionally, a source of listening education is consistent with students' perceptions, namely Spotify podcasts. This podcast is nearly identical to student impression, although the number is significantly higher at 8%. Besides, English films were also considered an effective online learning source. Students can benefit from learning materials in the form of films by better comprehending the context of the situation and gaining greater practical mastery of the language [3]. It means that the learning resources that we as teachers must prepare must be diverse—beginning with podcasts.

Furthermore, VOA (Voice of America) was considered a popular source for teaching listening comprehension to increase pupils' enjoyment of learning via a website. This finding is supported by the result of the interview in E5. This finding was supported with the previous study that VOA or BBC news resources can give students current information and language practice, as well as cultural awareness and practice with their listening ability [3].

*E5 : "Why I suggested to use VOA learning English website because the content offered by VOA websites covers a vast variety of subjects, the focus appears to be on western countries, particularly American culture." (T1)*

Lyrictraining website was also considered as the potential online learning resource in listening instruction. According to prior research, using the LyricsTraining application in the Basic Listening course can help students enhance their English mastery, particularly in terms of pronunciation, vocabulary knowledge, and listening skills [13].

Furthermore, in providing listening materials from a lecture or long talk, TEDtalks website was deemed as the favourite online learning resource. A prior study confirmed that watching TEDTalks benefits Indonesian EFL students by assisting them in acquiring new vocabulary, developing their listening comprehension, and increasing their enthusiasm [14].

## **Conclusion**

This study investigated perspectives of EFL teachers and EFL learners on online learning resources in mastering listening comprehension instruction. Over half of EFL students accessed YouTube to learn more listening comprehension with authentic learning videos. They also believed in various online learning

resources in mastering listening proficiency, including listening to music, Spotify podcasts to Duolingo, VOA learning English, BBC News, lyrical training applications, OmeTV, and Cambridge dictionary. Meanwhile, EFL teachers' perspectives on choosing online resources show that YouTube, lyrics training website, Spotify podcast, TEDTalk, English movie, and YouTube music are fruitful in listening instruction. Like EFL students, EFL teachers believed that YouTube plays a significant learning resource in mastering English listening comprehension. Therefore, EFL teachers must learn how to use technology to create educational videos for YouTube in order to enhance students' learning engagement in listening class.

## References

- [1] A. S. Alhabdan, "Evaluating english learning websites and digital resources from the perspective of saudi english language learners: Technical assessment," *Theory Pract. Lang. Stud.*, vol. 11, no. 6, pp. 639–651, 2021, doi: 10.17507/tpls.1106.07.
- [2] Y. C. Hsieh, "A case study of the dynamics of scaffolding among ESL learners and online resources in collaborative learning," *Comput. Assist. Lang. Learn.*, vol. 30, no. 1–2, pp. 115–132, 2017, doi: 10.1080/09588221.2016.1273245.
- [3] H. Shen, Y. Yuan, and R. Ewing, "English learning websites and digital resources from the perspective of Chinese university EFL practitioners," *ReCALL*, vol. 27, no. 2, pp. 156–176, 2014, doi: 10.1017/S0958344014000263.
- [4] R. L. Shively, "Developing interactional competence during study abroad: Listener responses in L2 Spanish," *System*, vol. 48, pp. 86–98, 2015, doi: 10.1016/j.system.2014.09.007.
- [5] N. E. Simbolon and F. Yusnita, "The selection of learning materials from Youtube resources for a Maritime English Course," *Indones. J. Appl. Linguist.*, vol. 10, no. 2, pp. 460–470, 2020, doi: 10.17509/ijal.v10i2.28587.
- [6] B. Zengin, D. Doğan, and F. Çubukçu, "English major students' attitudes towards movies and series as language learning resources," in *Intelligent Design of Interactive Multimedia Listening Software*, no. January, 2015, pp. 276–295.
- [7] Y. H. Huang, "Internet-Based Immersive Learning (IIL): Applying Ubiquitous Web 1.0 and Web 2.0 Resources in EFL Learning," in *Communications in Computer and Information Science*, 2019, vol. 1011, no. IIL, pp. 139–150, doi: 10.1007/978-3-030-20798-4\_13.
- [8] J. Fouz-González, "Podcast-based pronunciation training:

- Enhancing FL learners' perception and production of fossilised segmental features," *ReCALL*, vol. 31, no. 2, pp. 150–159, 2019, doi: 10.1017/S0958344018000174.
- [9] A. Yaacob, A. S. Amir Amir, R. M. Asraf, M. F. Mohd Yaakob, and F. M. Zain, "Impact of Youtube and Video Podcast on Listening Comprehension Among Young Learners," *Int. J. Interact. Mob. Technol.*, vol. 15, no. 20, p. 4, Oct. 2021, doi: 10.3991/ijim.v15i20.23701.
- [10] O. V. Anisimova, L. K. Bobodzhanova, K. S. Kolobova, and I. S. Makarova, "Integration of Internet Tools to Enhance Pronunciation Skills: Effectiveness of Educational Content on YouTube," in *Lecture Notes in Networks and Systems*, Mar. 2020, vol. 131, pp. 199–211, doi: 10.1007/978-3-030-47415-7\_21.
- [11] R. Nur and R. Syarifuddin, "Designing an Instructional Model of Youtube-Based Materials of Listening Comprehension at Umpar Indonesia," *Asian EFL J.*, vol. 20, no. 7, pp. 94–108, 2018.
- [12] E. Tomczak and R. Lew, "'The song of words' teaching multi-word units with songs," *3L Lang. Linguist. Lit.*, vol. 25, no. 4, pp. 16–33, 2019, doi: 10.17576/3L-2019-2504-02.
- [13] P. Angelina, "the Strengths and Drawbacks of Lyrics Training Implementation in Basic Listening Course," *ELTR J.*, vol. 4, no. 2, pp. 117–124, 2020.
- [14] E. I. Gavenila, M. Wulandari, and W. A. Renandya, "Using TED talks for extensive listening," *Pasaa*, vol. 61, no. June, pp. 147–175, 2021.

# Building Character Strengths through “new Islamic education” in Facing Era Society 5.0: Bibliometric reviews

Elihami<sup>22</sup>, Kana Safrina<sup>23</sup>, Riana Mashar<sup>24</sup>, Hary Murcahyanto<sup>25</sup>

## Introduction

The study of bibliometric networks, such as co-authorship, bibliographic coupling, and co-citation networks, has recently gotten much press. [14];[24];[44];[37];[13]. The core study on bibliometric networks, such as co-authorship, bibliographic coupling, and co-citation systems, has received much attention recently [25];[11]. The creation of these networks has received much less attention. We show out that a bibliometric network may be built using various methods [15]. The complete counting strategy is often utilized, but we offer a fractional counting approach. The fundamental premise behind the fractional counting technique is that each activity, such as co-authoring or referencing a publication, should be given equal weight, independent of a publication's number of authors, citations, or references [20]. We provide two actual studies where full and fractional counting methods produce substantially different outcomes. These studies focus on university co-authorship networks and journal bibliographic coupling networks. The fractional counting strategy is better than complete counting based on theoretical reasons and actual evaluations [10]. The creation of these networks has received much less attention. We show out that a bibliometric network may be built using various methods. The whole counting method is often utilized. However, we present an alternate fractional counting method. The fundamental premise behind the fractional counting technique is that each activity, such as co-authoring or referencing a publication, should be given equal weight, independent of a publication's number of authors, citations, or references. We provide two actual studies where full and fractional counting methods produce substantially different outcomes. These studies focus on university co-authorship networks and journal bibliographic coupling

---

<sup>22</sup> Muhammadiyah University of Enrekang, [elihamid72@gmail.com](mailto:elihamid72@gmail.com)

<sup>23</sup> Universitas Al Ata Yogyakarta, South Sulawesi

<sup>24</sup> Universitas Ahmad Dahlan, South Sulawesi

<sup>25</sup> Universitas Hamzanwadi

networks. We find that the fractional counting technique is better than complete counting for many applications based on theoretical reasons and empirical assessments.

Character (or social-emotional skills, or non-cognitive traits; the terminology is still in need of some standardization, but for the sake of this article, they may be used interchangeably) essential for long-term success, according to research [22]. We know that young people with more "grit" (passion for long-term goals) are more likely to graduate from under-resourced high schools, and we also know that preschoolers who can delay gratification have better economic and even health outcomes as adults than preschoolers who cannot delay gratification [23]. Recent research suggests that non-cognitive abilities, or what we would call "character," account for nearly half of what determines a young person's academic, post-secondary, job market, and life outcomes [33]. Simultaneously, we learn more about how these talents may be taught in school. According to long-term evaluations of the Perry Preschool program and other high-quality early childhood education programs, the cognitive (measured academic ability) benefits of attendance begin to fade in early primary school, according to long-term evaluations of the Perry Preschool program and other high-quality early childhood education programs [21]. Positive long-term life outcomes, including employment, wages, and reduced criminal justice participation, are greatly enhanced, probably due to a set of non-cognitive or character abilities or qualities cultivated and developed in high-quality preschool programs [2]. These talents and attributes, established in the initial years of life, pay off well into middle age.

'Islam and education' refers to the relationship between Islamic teachings and other social, political, and intellectual principles [5]. In this sense, the argument is part of a more extensive campaign to Islamize all aspects of society, such as economics, knowledge and science, politics, etc. [19];[18];[38]. By researching the discourse on Islam and education, this study aims to analyze the assumptions that support the language associated with character education in the industrial era 4.0.

They understand the role of character education in Islamic education reforms aimed at society 5.0. The intervention's circumstances may help to build more successful interventions, but the intervention area itself has to be strong enough to accommodate a wider variety of activities and methods that can also be beneficial [5];[1]. Individual elements such as the use of force, psychological

needs fulfillment, goal formulation, and goal accomplishment are investigated to give potential hints about how power interventions function [40]. However, the impact of relational or contextual elements, such as the intervention setting or the facilitator's attitude toward power on intervention effectiveness, has not been investigated [47]. The consequences of intervention in educational settings are discussed [48]. Can we learn more about Building Character Strengths via "new Islamic education" in the Facing Era Society"? Bibliometric reviews at 5.0?

Furthermore, if this is the case, can we learn more about what distinguishes them from their less powerful counterparts? These articles, in short, call for a new research agenda that focuses on developing testable interventions for classrooms, teachers, schools, and districts in order to accurately inform practice and ensure that more young people develop and leverage the skills that we now know are critical for long-term success [36]. We must commit to creating and replicating scalable techniques to create school and classroom cultures in which the virtues that this series of articles indicates are crucial to healthy development and academic accomplishment can lead and improve how schools run.

## Result and Discussion

The research outcomes remain presented by writing the processed data of the trend of publication in 2000-2021 is 'new Islamic education' trend using the Publish or Perish application.

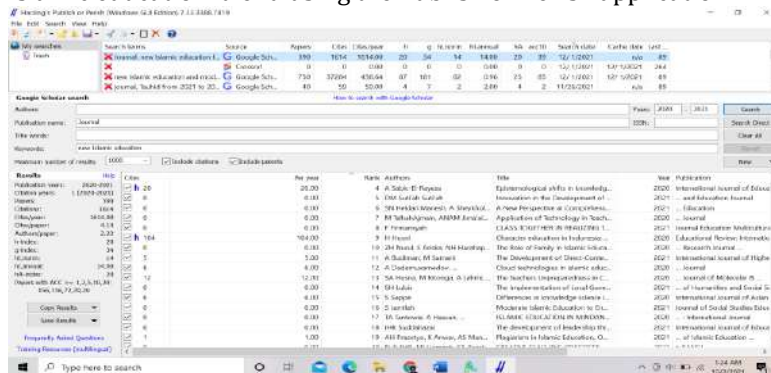
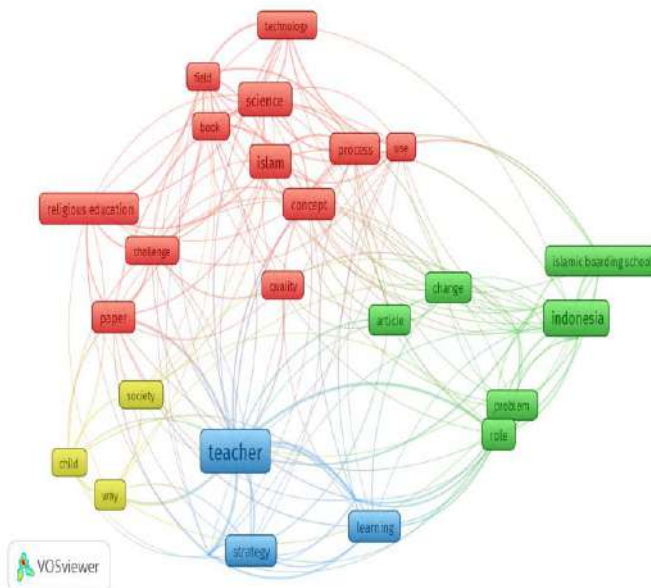


Figure 1 the Publish or Perish

The initial exploration results of the Publish or Perish application resulted in 390 papers. From 2000 to 2021, this research aims to provide a comprehensive analysis of the "new Islamic

education" trend. The information was obtained from the Science Citation Index database of Google Scholar. A qualitative methodology was used in the investigation using Harzing's Publish or Perish (Windows GUI Edition) 7.33.3388.7819. All the files were evaluated, and data such as titles, author affiliations, and publication dates were recovered and exported to Excel. There were 390 articles published in total, h-index 20, with 1614 citations. Between 2000 until 2021, most outcomes (n = 390) were published. Bibliometrics analysis can be used by scientists and growth of the Islamic education interested in Publish or Perish about new Islamic education. This research uses a bibliographic study design and systematic and explicit mapping approaches. A qualitative case study was done to approach the research to understand better new Islamic education and modern. Vosviewer application was utilized in this study. From November 10 through December 03, 2021, the questionnaire was available online via a bibliometrics mapping system and other technologies by using the online application.



**Figure 2. Network Visualization about New Islamic Education and Modern**

Figure 1 showed that the initial exploration results utilizing the Publish or Perish application resulted in 380 bibliographies sorted

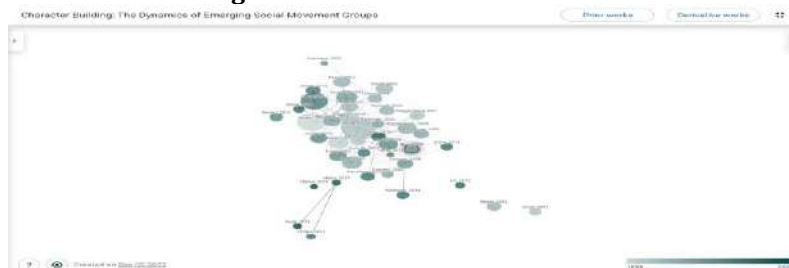


into 80 designated bibliographies. Three hundred bibliographies were not nominated because they did not meet the established criteria. Figure 1 showed that twenty-nine items of four clusters resulted from searches through VOS viewer. The first cluster (12 items) was a book, challenge, concept, field, Islam, paper, process, quality, religious studies, science, use, and technology. The second clusters (9 items) were article, change, Indonesia, Islamic boarding school, Islamic education institution, person, practice, problem, and role. The third clusters (5 items) were Islamic education teacher, Islamic religious education, learning, strategy, and teacher. And then, the fourth clusters (3 items) were child, society, and way.

Connector papers between “new Islamic education and building character.”



**Figure 3. new Islamic education**



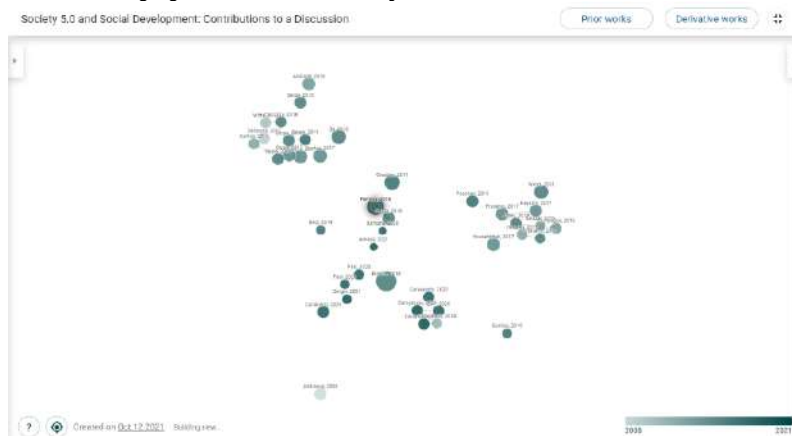
**Figure 4. building character**

### **Building character strengths**

Character characteristics are critical for long-term success, and a growing body of evidence suggests that schools, and teachers, in particular, may be beneficial in assisting kids in developing these abilities throughout their teenage years [34];[43]. Developing tested treatments to help young people develop and use these essential

talents in school and classroom situations [45];[26];[39];[3]. Character development is a crucial component that demonstrates the system's emphasis [27];[4];[42];[30]. Religious moral education has significantly impacted the literature [28]. Good character will be a foothold in Character education, as it is an education that instills habituation of admirable qualities so that learners comprehend what is good and wrong [12];[29];[35];[32].

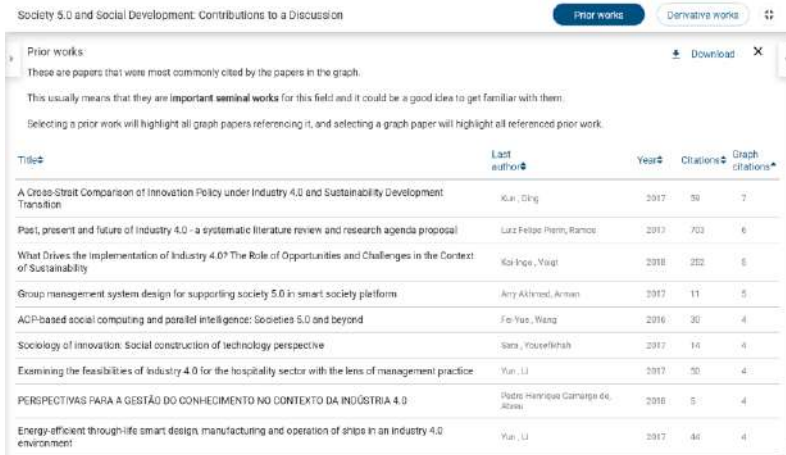
### Connector papers about "society 5.0."



**Figure 5. Society 5.0**

Figure 5 shows that to reach 5.0, society's viewpoint must reconsider two sorts of interactions: the connection between individuals and society mediated by technology and the link between technology and society. According to Society 5.0's fundamental schema, data is gathered from the "real world" and evaluated by computers, with the results being implemented in the real world. [17]. In terms of itself, this structure is not groundbreaking. Air-conditioning systems, for example, keep a room's temperature consistent with the machine's setting [46]. An air conditioner detects the temperature of the room regularly, and an inbuilt microprocessor compares the measurement to the recorded temperature setting [9]. The airflow is automatically activated or halted depending on the outcome, ensuring that the room is kept at the correct temperature. This basic idea is applied in many of the systems that we rely on in our daily lives [8]. It underpins the mechanisms that keep our houses well-supplied with energy and the trains operating on schedule [6]. Computerized automatic controls are used in this system [31]. When

people talk about an "information society," they refer to a society in which each of these systems collects data, analyzes it, and then applies what they have learned to a particular real-world issue.



**Figure 6. prior works about society 5.0**

Figure 6 shows prior works about society 5.0. So, what distinguishes Society 5.0? Society 5.0 will feature systems that work together to keep society functioning well, rather than each system having a specific scope, such as keeping a space pleasant, generating energy, or ensuring that trains run on time [41];[7]. It is not enough to have pleasant room temperatures to assure enjoyment and comfort. Comfort is required in many parts of life, including energy, transportation, medical care, shopping, education, employment, and recreation. To do this, systems must collect a wide range of real-world data [16]. The knowledge gleaned from such processing must then be used in the actual world to make our lives easier and more enjoyable. Isn't this, however, already the case? The difference is that in Society 5.0, the generated data will directly impact our activities and behavior, rather than only guiding the functioning of an air conditioner, generator, or railway. In summary, Society 5.0 will include an iterative cycle in which data is acquired, evaluated, and then translated into practical knowledge, implemented in the actual world; this cycle will also function at a societal level.

## Conclusion

The character strengths-based activities through “new Islamic education” in Facing Era Society 5.0: Bibliometric reviews.,

those who did have considerably higher levels of life satisfaction. Overall, the findings offer preliminary support for incorporating character strengths-based activities into school curricula as a method of improving young life satisfaction and well-being. Character traits are essential for long-term success, and a growing body of data shows that schools may be effective locations, and teachers can be potent agents in helping students develop these strengths throughout their adolescent years. The essays in this book advance the field in significant ways, leading to a clear research agenda focused on developing tested treatments to help young people grow and use these crucial strengths in school and classroom settings.

## References

- [1] Agustiniingsih, H., & Wahyuningsih, S. (2018). *The decision of Linked with Narcotics Convicted in Act No. 35 Of 2009 in The District of Sumber Court*. <https://doi.org/10.30659/jdh.v1i3.3343>
- [2] Arboledas, D. (2019). A new character-level encryption algorithm: Implementing cryptography in an ICT classroom. *Journal of Technology and Science Education*. <https://doi.org/10.3926/JOTSE.491>
- [3] Arti, Y., & Ikhsan, J. (2020). *The profile of Junior High School students' critical thinking skills and concept mastery level in local wisdom based on outdoor learning*. <https://doi.org/10.1088/1742-6596/1440/1/012105>
- [4] Arumsari, C., A, N. H., & Isti'adah, F. N. (2019). The Ideal Character of Students Based on Moral Values in Short Movie Videos. *Journal of Physics: Conference Series*. <https://doi.org/10.1088/1742-6596/1179/1/012097>
- [5] Baihaqi, M. (2018). *Building Character Education in Basic School by Positive Virtues Universal*. <https://www.semanticscholar.org/paper/7b29bcd569ca59e81bff4137375d83e593db644f>
- [6] Baumeister, R. (1993). *Self-esteem: The puzzle of low self-regard*. <https://doi.org/10.1007/978-1-4684-8956-9>
- [7] Baumeister, R., Heatherton, T., & Tice, D. (1993). When ego threats lead to self-regulation failure: Negative consequences of high self-esteem. *Journal of Personality and Social Psychology*, 64 1, 141–156. <https://doi.org/10.1037/0022-3514.64.1.141>
- [8] Baumeister, R., Smart, L., & Boden, J. (1996). Relation of threatened egotism to violence and aggression: The dark side of

- high self-esteem. *Psychological Review*, 103 1, 5–33. <https://doi.org/10.1037/0033-295X.103.1.5>
- [9] Blascovich, J., & Tomaka, J. (1991). *Measures of self-esteem*. <https://doi.org/10.1016/B978-0-12-590241-0.50008-3>
- [10] Börner, K., Chen, C., & Boyack, K. (2005). Visualizing knowledge domains. *Annu. Rev. Inf. Sci. Technol.*, 37, 179–255. <https://doi.org/10.1002/aris.1440370106>
- [11] Boyack, K., Klavans, R., & Börner, K. (2004). Mapping the backbone of science. *Scientometrics*, 64, 351–374. <https://doi.org/10.1007/s11192-005-0255-6>
- [12] Cahyadi, A., Hendryadi, Widyastuti, S., Mufidah, V. N., & Achmadi. (2021). Emergency remote teaching evaluation of the higher education in Indonesia. *Heliyon*, 7(8). <https://doi.org/10.1016/J.HELIYON.2021.E07788>
- [13] Callon, M., Courtial, J., Turner, W., & Bauin, S. (1983). From translations to complex networks: An introduction to co-word analysis. *Social Science Information*, 22, 191–235. <https://doi.org/10.1177/053901883022002003>
- [14] Cobo, M., López-Herrera, A. G., Herrera-Viedma, E., & Herrera, F. (2011a). An approach for detecting, quantifying, and visualizing the evolution of a research field: A practical application to the Fuzzy Sets Theory field. *J. Informetrics*, 5, 146–166. <https://doi.org/10.1016/j.joi.2010.10.002>
- [15] Cobo, M., López-Herrera, A. G., Herrera-Viedma, E., & Herrera, F. (2011b). Science mapping software tools: Review, analysis, and cooperative study among tools. *J. Assoc. Inf. Sci. Technol.*, 62, 1382–1402. <https://doi.org/10.1002/asi.21525>
- [16] Coopersmith, S. (1967). *The antecedents of self-esteem*. <https://doi.org/10.2307/2092806>
- [17] Crocker, J., Thompson, L. L., Mcgraw, K., & Ingerman, C. (1987). Downward comparison, prejudice, and evaluations of others: Effects of self-esteem and threat. *Journal of Personality and Social Psychology*, 52 5, 907–916. <https://doi.org/10.1037/0022-3514.52.5.907>
- [18] Daun, H., & Walford, G. (2004). *Educational strategies among Muslims in the context of globalization: Some national case studies*. <https://semanticscholar.org/paper/895f304f9b77cfd9ef4e1a42df352dde5e7b73de>
- [19] Douglass, S., & Shaikh, M. (2004). Defining Islamic Education: Differentiation and Applications. *Current Issues in Comparative Education*, 7, 5–18.

- <https://semanticscholar.org/paper/f20a9065e1456e99c61c0d52bedc3334833c2eae>
- [20] Eck, N. J. van, & Waltman, L. (2009). Software survey: VOSviewer, a computer program for bibliometric mapping. *Scientometrics*, *84*, 523–538. <https://doi.org/10.1007/s11192-009-0146-3>
- [21] Halstead, M. (2004). An Islamic concept of education. *Comparative Education*, *40*, 517–529. <https://doi.org/10.1080/0305006042000284510>
- [22] Hashim, R. (1996). *Educational Dualism in Malaysia: Implications for Theory and Practice*. <https://doi.org/10.2307/2658815>
- [23] Hidi, S., & Renninger, K. A. (2006). The Four-Phase Model of Interest Development. *Educational Psychologist*, *41*, 111–127. [https://doi.org/10.1207/s15326985ep4102\\_4](https://doi.org/10.1207/s15326985ep4102_4)
- [24] Hirsch, J. (2005). An index to quantify an individual's scientific research output. *Proc. Natl. Acad. Sci. USA*, *102*, 16569–16572. <https://doi.org/10.1073/pnas.0507655102>
- [25] Jan, V. & WaltmanLudo. (2009). How to normalize cooccurrence data An analysis of some well-known similarity measures. *Journal of the Association for Information Science and Technology*. <https://www.semanticscholar.org/paper/f205fa86f3da7a9f035a236ad5cebf5e337344cf>
- [26] Jannah, T., Astuti, C. C., & Suwarta, N. (2020). The Influence of Cooperative Learning Model Type Thinks Pair Share Assisted by FlipBook Media on Learning Outcomes in Graphic Design Subjects for Class X RPL Students at SMK PGRI 2 SIDOARJO. *Proceedings of The ICECRS*. <https://doi.org/10.21070/icecrs2020524>
- [27] Jaya, D. R., Sauri, S., Muchtar, H. S., & Warta, W. (2019). Strengthening Student Character Education Through Investing Multicultural Values in Madrasah. *International Journal of Nusantara Islam*. <https://doi.org/10.15575/ijni.v7i2.12587>
- [28] Jelili Amuda, Y. (2021). Enhancing national progress and sustainable economic development among Al-Majiri children in Northern Nigeria. *Heliyon*, *7*(9), e08066. <https://doi.org/10.1016/J.HELIYON.2021.E08066>
- [29] Kaymakcan, R., & Meydan, H. (2012). Values in the Curricula of Religious Education and Social Studies in Primary Schools in the Context of Local-Universal Dilemma\*. *Kuram Ve Uygulamada Egitim Bilimleri*, *12*, 1588–1591. <https://www.semanticscholar.org/paper/6e0f89f970a93287861672c1036e0b4cac97aed4>

- [30] Khairunisa, N. (2017). *The Implementation of Value Clarification Technique (VCT) Learning Model to Improve Social Care Character in Social Science Learning*. <https://doi.org/10.17509/IJPOSS.V2I1.8689>
- [31] Lee, D. (1969). Society and the Adolescent Self-Image. *Sociology*, 3, 280–280. <https://doi.org/10.1177/003803856900300250>
- [32] Lestari, O., Priscylio, G., Copriady, J., & Holiwarni, B. (2020). *The use of quartet card game on hydrocarbon to improve learning outcomes, ten-grade students*. <https://doi.org/10.1088/1742-6596/1567/3/032096>
- [33] Lukens-Bull, R. (2001). Two Sides of the Same Coin: Modernity and Tradition in Islamic Education in Indonesia. *Anthropology & Education Quarterly*, 32, 350–372. <https://doi.org/10.1525/AEQ.2001.32.3.350>
- [34] Muchsin, S. B., Kamaruddin, R., & Rosida, V. (2018). *Developing Learning Instruments of Geometry Based on Van Hiele Theory to Improving Students' Character*. <https://doi.org/10.1088/1742-6596/1028/1/012137>
- [35] Muliana, Yusiran, Agustinasari, Asriyadin, Susilawati, E., Sarnita, F., Siswanto, Gumilar, S., Gustina, Erwinsyah, A., Utami, L., Amiruddin, A., & Syahrir. (2019). Using inductive approach (IA) to enhance students' critical thinking (CT) skills. *Journal of Physics: Conference Series*. <https://doi.org/10.1088/1742-6596/1280/5/052035>
- [36] Murtako, M. (2015). CULTURE-BASED CHARACTER EDUCATION IN MODERNITY ERA. *Ta'dib*, 20, 149–164. <https://doi.org/10.19109/TD.V20I1.326>
- [37] Peters, H. P. F., & Raan, A. (1993). Co-word-based science maps of chemical engineering. Part I: Representations by direct multidimensional scaling. *Research Policy*, 22, 23–45. [https://doi.org/10.1016/0048-7333\(93\)90031-C](https://doi.org/10.1016/0048-7333(93)90031-C)
- [38] Pohl, F. (2006). Islamic Education and Civil Society: Reflections on the Pesantren Tradition in Contemporary Indonesia. *Comparative Education Review*, 50, 389–409. <https://doi.org/10.1086/503882>
- [39] Rahayu, A. P., Darmahusni, & Dewanti, R. (2018). THE PRAXIS OF HONESTY BUILDING AT SMPN 1 PEKANBARU. *IJLECR - INTERNATIONAL JOURNAL OF LANGUAGE EDUCATION AND CULTURE REVIEW*. <https://doi.org/10.21009/ijlecr.042.13>
- [40] Ramdhani, M., Jamaluddin, D., & Ainissyifa, H. (2015). *Building a moderate attitude through character education*.

- <https://www.semanticscholar.org/paper/9f1a23770463f182d2e93402c7032b35a449e550>
- [41] Rosenberg, M. (1966). *Society and the adolescent self-image*. <https://doi.org/10.2307/2091308>
- [42] Rusijono, & Khotimah, K. (2018). *The implementation of an assessment model based on character building to improve students' discipline and achievement*. <https://doi.org/10.1088/1757-899x/296/1/012040>
- [43] Sarah, I., & Rani, S. (2020). *Effectiveness of student worksheets on environmental project-based e-learning model in building student character*. <https://doi.org/10.1088/1742-6596/1521/3/032005>
- [44] Small, H. (1973). Co-citation in the scientific literature: A new measure of the relationship between two documents. *J. Am. Soc. Inf. Sci.*, 24, 265–269. <https://doi.org/10.1002/asi.4630240406>
- [45] Sokatch, A. (2017). Toward a Research Agenda: Building Character Strengths in School Settings. *Undefined*, 46(6), 1238–1239. <https://doi.org/10.1007/S10964-017-0657-9>
- [46] Taylor, S. E., & Brown, J. D. (1988). Illusion and well-being: A social psychological perspective on mental health. *Psychological Bulletin*, 103 2, 193–210. <https://doi.org/10.1037/0033-2909.103.2.193>
- [47] Widiastuti, K., & Perbowosari, H. (2018). Character Education Value in the Ngendar Tradition in Piodalan at Penataran Agung Temple. *Vidyottama Sanatana: International Journal of Hindu Science and Religious Studies*. <https://doi.org/10.25078/IJHSRS.V2I2.624>
- [48] Yuliana, H. (2018). Counting of Z-generation with the development of work-based characters in practices learning. *TAMAN VOKASI*. <https://doi.org/10.30738/JTV.V6I2.4149>



# Ultraviolet Exposure to Energy Intake Synthesis of Vitamin D

Emillia Devi Dwi Rianti

## Introduction

In early 2020, the novel coronavirus was identified, and the World Health Organization (WHO) officially stated that the disease that causes pneumonia is the SARS-CoV-2 (Severe acute respiratory syndrome coronavirus). (Corona Virus Disease 2019), due to the coronavirus that emerged at the end of December 2019 [1]. The spread of the Covid-19 virus is increasing until all countries in the world and WHO announce that Covid-19 is a pandemic disease. Indonesia is one of the countries that has been confirmed to have spread Covid-19 virus, the virus belongs to the betacoronavirus genus and has similarities to SARS. The immune response can determine the severity of Covid-19 infection, the severity factor of viral infection is the cytopathic effect of the virus and the ability to defeat the immune response. The spread of coronavirus starts from transmission animal to human and spread from human to human man. The spread that occurs in humans can be seen from the tests carried out with changes in the lungs, and the average number of lymphocytes and platelets shows lower results and is accompanied by hypoxemia.[2]

Infections caused by Covid-19 can result in death, according to the Centers for Disease Control and Prevention (CDC) which recommends that vitamin D can reduce infections from Covid-19. Respiratory tract infections, diabetes, cardiovascular and autoimmune diseases are diseases of vitamin D3 deficiency [3]. Increased synthesis of vitamin D through fortification, vitamin D supplementation and through sun exposure can increase serum 25(OH)D. The relationship with the condition of sun exposure in summer, there is an increase in serum 25(OH)D compared to winter. Serum 25(OH)D above 30 ng/ml.6 is found in areas near the equator that are exposed to sunlight. Decreased efficiency of calcium and phosphorus distribution which can increase parathyroid hormone (PTH) is caused by vitamin D deficiency. Vitamin D deficiency can increase the risk of insulin resistance [4].

The most important preventive measure for Covid-19 can be seen with macro and micronutrient status, this is related to two directions, namely between diet, nutrition, infection and the immune system. Vitamin D is a micronutrient that is very important for the

body's defense against pathogens. Effects against respiratory infections can be achieved with vitamin D protection, because serum vitamin D can provide very adequate supplementation against respiratory infections. The recognized antiviral, immunomodulatory and cardiometabolic effects of Vitamin D help fight Covid-19. Vitamin D in research can reduce the apoptosis of type II alveolar epithelial cells (pneumocytes), stimulate surfactant synthesis in cells preventing severe lung injury such as ARDS [5]. Vitamin D may also have endothelial cell function, induction effects, autophagy (targeting intracellular pathogens), regulation of innate cytokines (eg, IL-1 $\beta$ ), as well as inhibition of pro-inflammatory cytokine production. Vitamin D supplementation based on clinical trials is reported to reduce the incidence of acute respiratory infections, the severity of the respiratory tract [6].

The benefits of vitamin D are useful for the body, this vitamin is obtained in the body and outside the body. Vitamin D is also known as sunshine, and starts from 7-dehydroxylase located in the epidermis and dermis which is transformed into active vitamin D caused by UV radiation B rays from the body. Vitamin D which is synthesized with the help of the sun becomes the main supply for the body, in the form of vitamin D will last longer than food sources [7]. The form of vitamin D has 2 forms, namely D2 (ergocalciferol) and vitamin D3 (cholecalciferol), for vitamin D3 produced by the body can also be obtained from supplements. Both vitamin D is synthesized from ultraviolet (UV) radiation, UV B light which is radiation can convert 7-dehydrocholesterol in the skin into active vitamin D. Vitamin D can be converted by the liver to 25-hydroxyvitamin D3 (25(OH)D3) and in the kidney to calcitriol (1,25(OH)2D3). Vitamin D in its activation is assisted by magnesium, then vitamin D together with minerals regulates phosphate and calcium for bone growth [8].

The wavelength range of ultraviolet (UV) light has a range of 400 nano meters to 100 nano meters, and in the X-ray and visible light ranges. Ultraviolet based on the wavelength is divided into three, namely; ultraviolet A or what is called black light which has a wavelength of about 380 nano meters to 315 nano meters, for ultraviolet B it is called a medium wave with a wavelength between 315 nano meters to 280 nano meters, and ultraviolet C or light waves. short wave which has a wavelength between 280 nano meters to 100 nano meters. Ultraviolet or UV light is an electromagnetic wave, and is solar radiation that reaches the earth's surface at a wavelength of 100 nm to 1 mn. Sunlight that has UV consists of UV A rays with a

wavelength (320-400nm) which reaches the earth's surface more than 90% and penetrates into the skin in the dermis (deep) layer of the skin, UV B with a wavelength (290-320) and 5% Among all UV, some are absorbed by the stratum corneum or the outermost layer of the skin and some are absorbed by the stratum corneum, some of which penetrate the dermis of the skin. The wavelength of ultraviolet C is 200 to 290 nm, but the radiation cannot reach the earth's surface [9].

The synthesis of vitamin D is influenced by the area of the body exposed to sunlight, the lower the solar energy, the lower the sun's exposure to the skin area, so the lower the risk of sun exposure. Vitamin D production of 10 g(400 IU) time required to reach based on MED is appropriate for Fitzpatrick type III, total area of exposure for skin is 600 cm<sup>2</sup> worth 1/3 of that. Minimal Erythema Dose (MED) has the understanding that it is used as a reference to find out how long it takes to sunbathe with a dose of UVB with the aim of obtaining the most optimal results in producing vitamin D, and reducing side effects that can be detrimental. If the alignment is doubled, then the area of the alignment is one thousand two hundred cm<sup>2</sup>, and the time required is half of the time required by the skin area. The length of time required under short conditions is defined as the reduced risk of overexposure and maximum benefit [10].

## **Discussion**

Currently, developing countries with one of them Indonesia is the fourth most populous country in the world. The condition of the high population in conditions when the coronavirus hit other countries, and quick steps were taken to escape and get out of the condition of the increasing number of Covid-19 sufferers by issuing travel restrictions from Hubei province, which is the center of the overall spread of Covid-19. A new disease that has not yet been identified spreading in humans is Coronavirus Disease 2019 (COVID-19). The beginning of transmission through animals to humans, with the corona virus being zoonotic and the condition based on transmission between animals and humans is unclear and uncertain.

Transmission that occurs between humans and humans, this virus is transmitted through coughing or sneezing (droplets), people who are close and in close contact with sufferers are at risk of contracting this disease. Based on the Indonesian Ministry of Health in 2020, people who treat Covid-19 patients can be infected. Infection with the Covid-19 virus has an impact on death, and based on

observations it can occur in patients who are elderly, have a history of diabetes, heart disease, and other chronic diseases. So there is an assumption based on differences in the strength of the body's immune system, so that in adulthood there will be a stronger immune system than the elderly. Death from the virus is generally a 'self-limiting disease' by relying on the patient's body's defense strength. The occurrence of a cytokine storm condition triggers a pathogenic immune response that results in multiple organ failure and death in Covid-19 cases.

Foreign substances that can enter the body can be restrained by the body's immune system or immune system. This form of attack can come from within the body or from outside the body. The cells of the host body that are attacked by the virus so that the body is infected by the virus that survives by multiplying or replicating in the host cell [11]. Then the immune system can be increased or suppressed, by giving immunomodulators which are compounds that are able to interact with the immune system so that they can increase or decrease the immune response. Dosage or timing of certain compounds can decrease or increase the immune response. The condition of the Covid-19 pandemic requires immunostimulants to increase the body's ability to ward off viral infections. One of them is by increasing immunity by using vitamin D, it is explained that there is a positive relationship between vitamin D and Covid-19 infection. Epidemiological studies explain that low plasma vitamin D levels can lead to the occurrence or severity of viral infections in the human respiratory system, and demonstrate the important role of vitamin D in the prevention or treatment of respiratory tract infections.

Research has shown that 7-dehydroxylase is the origin of vitamin D, which is located in the epidermis and dermis layer which becomes vitamin D from the transformation process. It also explains that active vitamin D is caused by UVB radiation from the body. Ultraviolet (UV) radiation comes from the sun or the sun, by emitting various kinds of light, both visible and invisible. Visible sunlight is the light emitted with a wavelength of more than 400 nm, while the invisible sunlight has a wavelength ranging from 10 - 400 nm). Most of the rays that reach the earth's surface are infrared (56%), followed by visible light (39%), ultraviolet (UV): UVA (almost 5%) and UVB (0.1%). Ultraviolet (UV) light has a wavelength between 400 nm-100 nm and is located in the spectrum of X-rays and visible light. The use of ultraviolet light is based on the explanation that vitamins D2 and D3 are synthesized from UV light, with the process of changing 7-

dehydrocholesterol in the skin from exposure to UV B radiation, resulting in active vitamin D. Then vitamin D is converted by the liver to 25-hydroxyvitamin D<sub>3</sub> (25(OH)D<sub>3</sub>) and in the kidney it is converted to calcitriol (1,25(OH)<sub>2</sub>D<sub>3</sub>) [9].

Control comes from the occurrence of processes and functions of lymphocyte cells derived from vitamin D, with this role it can regulate the occurrence of T cells so that vitamin D supports the activity of antibacterial and antiviral immunity. The levels of pro-inflammatory cytokines and the effectiveness of the immune response to infection are significantly reduced, which is due to vitamin D deficiency [12]. The occurrence of vitamin D<sub>3</sub> produced by 7-dehydrocholesterol in the skin, with the help of ultraviolet light or sunlight will be converted into pre vitamin D.

Then pre vitamin D undergoes thermal isomerization or further ultraviolet light irradiation to become vitamin D<sub>3</sub>. So the use of ultraviolet in immune enhancement is needed to suppress the virus. With a wavelength of 290-320 nm from the use or utilization of sunlight by 5% obtained from UV B. The study looked at the effect of exposure to ultraviolet blight sourced from sunlight on the concentration of vitamin D (25(OH)D). The sun or the sun at UV B occurs at a time range from 07.00 am to 11.00 am, after 11.00 to 14.00 the intensity is relatively stable and high, then at 14.00 to 16.00 it decreases again like at 07.00. The time used at 09.00 is right for heating and it is done three times a week. 0.9.00 was used, because the intensity achieved was 0.6 MED/hour so that the exposure time was 25 minutes ( $1/4 \times 1 \text{ MED} / 0.6 \text{ MED} \times 60 \text{ minutes}$ ) [13].

## Conclusion

Ultraviolet (UVB) with a wavelength of 290-320 nm from 5% sunlight with an exposure time of 07.00 to 11.00 ( $1/4 \times 1 \text{ MED} / 0.6 \text{ MED} \times 60 \text{ minutes}$ ) can produce vitamin D<sub>3</sub> which is obtained from 7-dehydrocholesterol in skin.

## References

- [1] I. Thevarajan *et al.*, "Breadth of concomitant immune responses prior to patient recovery: a case report of non-severe COVID-19," *Nat. Med.*, vol. 26, no. 4, p. 1, Apr. 2020, doi: 10.1038/S41591-020-0819-2.
- [2] J. F. W. Chan *et al.*, "A familial cluster of pneumonia associated with the 2019 novel coronavirus indicating person-to-person transmission: a study of a family cluster," *Lancet (London)*,

- England*), vol. 395, no. 10223, p. 514, Feb. 2020, doi: 10.1016/S0140-6736(20)30154-9.
- [3] M. Fiannisa, "WAKTU BERJEMUR TERBAIK GUNA MENINGKATKAN VITAMIN D DALAM PENCEGAHAN CORONAVIRUS DISEASE 2019 (COVID-19)," *J. MEDIA Kesehat.*, vol. 14, no. 1, pp. 66–74, Jun. 2021, doi: 10.33088/jmk.v14i1.622.
  - [4] B. Yosephin, A. Khomsan, D. Briawan, and R. Rimbawan, "Peranan Ultraviolet B Sinar Matahari terhadap Status Vitamin D dan Tekanan Darah pada Wanita Usia Subur," *Kesmas J. Kesehat. Masy. Nas. (National Public Heal. Journal)*, vol. 0, no. 0, pp. 256–260, Jan. 2014, doi: 10.21109/KESMAS.V0I0.377.G376.
  - [5] S. X. Zheng *et al.*, "Vitamin D attenuates lung injury via stimulating epithelial repair, reducing epithelial cell apoptosis and inhibits TGF- $\beta$  induced epithelial to mesenchymal transition," *Biochem. Pharmacol.*, vol. 177, Jul. 2020, doi: 10.1016/J.BCP.2020.113955.
  - [6] Y. Y. T. Seran, B. Pasangka, and H. I. Sutaji, "Karakteristik paparan radiasi sinar ultraviolet A (UV-A) dan cahaya tampak di Kota Kupang," *J. Biotropikal Sains*, vol. 15, no. 3, pp. 49–56, 2018.
  - [7] Riskita Fiannisa, "Vitamin D sebagai Pencegahan Penyakit Degeneratif hingga Keganasan: Tinjauan Pustaka," *Medula | Volume 9 | Nomor 3/Oktober 2019*, Oct. 04, 2019. <https://juke.kedokteran.unila.ac.id/index.php/medula/article/viewFile/2509/pdf> (accessed Dec. 12, 2021).
  - [8] A. A. Ginde *et al.*, "High-Dose Monthly Vitamin D for Prevention of Acute Respiratory Infection in Older Long-Term Care Residents: A Randomized Clinical Trial," *J. Am. Geriatr. Soc.*, vol. 65, no. 3, pp. 496–503, Mar. 2017, doi: 10.1111/jgs.14679.
  - [9] M. Turtoi, U. Dunarea, and D. J. Galati, "Ultraviolet light potential for wastewater disinfection," no. July, 2014.
  - [10] W. B. Grant *et al.*, "Evidence that Vitamin D Supplementation Could Reduce Risk of Influenza and COVID-19 Infections and Deaths," *Nutr. 2020, Vol. 12, Page 988*, vol. 12, no. 4, p. 988, Apr. 2020, doi: 10.3390/NU12040988.
  - [11] G. Manukyan *et al.*, "Host immune Response to influenza A virus infection," vol. 9, 2018, doi: 10.3389/fimmu.2018.00320.
  - [12] S. Quezada *et al.*, "Immune response modulation by vitamin D: role in systemic lupus erythematosus," p. 12, 2015, doi: 10.3389/fimmu.2015.00513.
  - [13] S. Setiati, "Pengaruh Paparan Sinar Ultraviolet B Bersumber dari Sinar Matahari terhadap Konsentrasi Vitamin D (25(OH)D) dan

Hormon Paratiroid pada Perempuan Usia Lanjut Indonesia,”  
*Kesmas J. Kesehat. Masy. Nas. (National Public Heal. Journal)*, vol.  
2, no. 4, pp. 147–153, Feb. 2008, doi:  
10.21109/KESMAS.V2I4.257.

## **Description of Maternal-Fetal Attachment in Public Health Community Center Yogyakarta**

Endang Koni Suryaningsih, Sri Subiyatun

### **Introduction**

Pregnancy is a normal phenomenon that occurs due to the meeting of sperm cells with egg cells in the fallopian tube, then it binds to the endometrial layer which will develop into a fetus, for 280 days or 40 weeks. Pregnancy is a time when the body of a pregnant woman undergoes physical and psychological changes. In this period women will feel a certain joy, but some women experience shock, denial and uncertainty arises, especially in women who are not ready to face the crisis period of pregnancy.[1]. Psychological changes in the third trimester of a pregnant woman begin to feel afraid of the pain and danger that will arise during childbirth and feel worried for the safety of her fetus. The discomfort reappears in the third trimester and many mothers feel they are strange, messy, awkward and ugly, so they need more attention from their families, especially husbands.

Maternal-fetal attachment plays an important role in the health of pregnant women and fetuses and has an influence on the mother's decision to behave in a healthy life during pregnancy. Maternal - fetal attachment is the relationship between mother and fetus during pregnancy. This can be seen as the mother's involvement in showing love, care and commitment to maintaining the health of the fetus. According to Condon and Corkindale[2] There are five components of the attachment of mother and fetus during pregnancy, namely wanting information about the health of the fetus, pleasure to interact with the fetus, wanting to care for the fetus and serving its needs during pregnancy.

States that Maternal-fetal attachment is carried out during pregnancy because it plays an important role in the health of the mother and fetus and has a positive impact on the mother and fetus in the future social, emotional and child development, and as gestational age increases, the maternal rate increases. -fetal attachment felt in pregnant women. If maternal-fetal attachment is not carried out during pregnancy, it will have a negative impact on the future of the mother and the development of the fetus[3]. State that when a fetus does not have someone who loves it, then in the future, it will grow into an emotional child [4]. Therefore, the theory of inner bonding has implications for fetuses who have the natural ability to transmit roles



when they experience stress or pain and parents will also have the sensitivity to be able to communicate with the fetus. States that children are the backbone of the next generation of a nation to produce a brilliant generation, which will be determined by women as mothers or prospective mothers who will care for and educate their children. This is a very important role, when the inner bond between mother and child has begun to form since the pregnancy process[4].

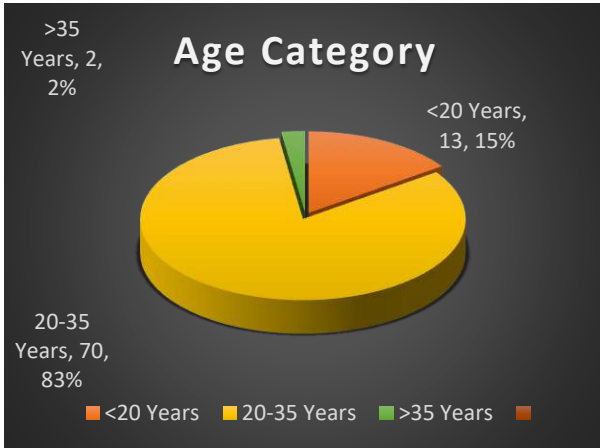
In Indonesia, research on maternal-fetal attachment is still very limited [5][4][6] and not much exposure to pregnant women about the importance of growing the inner bond between mother and fetus or in other terms maternal-fetal attachment as part of health promotion efforts. With regard to the importance of the role of health promotion in health services, a National Health Promotion policy has been established in accordance with the Decree of the Minister of Health Number 1193/Menkes/SK/X/2004. This policy is also supported by the Decree of the Minister of Health Number 1114/Menkes/SK/VII /2005 concerning Guidelines for the Implementation of Health Promotion in the Regions. To carry out these mandatory health efforts at puskesmas, it is necessary to have health workers, especially midwives, to manage health promotion regarding maternal-fetal attachment in puskesmas in a professional manner and be able to manage and provide promotive and preventive services. Based on this background description, the research is interested in conducting research on the description of maternal-fetal attachment in third trimester pregnant women.

## **Results and Discussion**

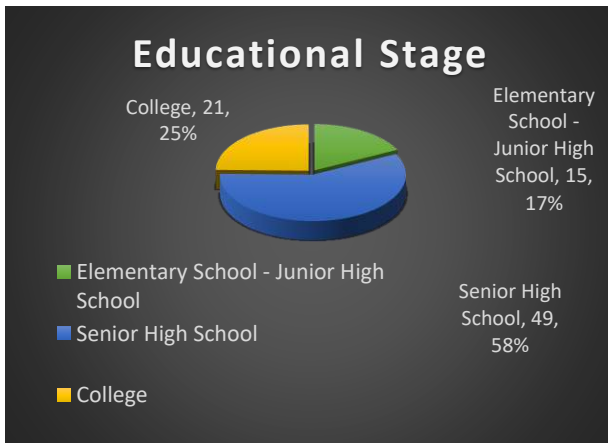
### **Characteristics of Respondents by Age Category**

Eighty-five primigravida mothers who have met the inclusion criteria participated in the survey in this study. The majority of respondents are in the age range of 20-35 years, ie as many as 83% or 70 people, while respondents who are more than 35 years old are only 2% or as many as 2 people. While the rest are groups of respondents aged less than 20 years, namely 15% or 13 people (Figure 1). The education level of the respondents in this study was dominated by high school graduates as much as more than 50%, while 25% of respondents who completed their education at the tertiary level. A total of 17% of respondents attended junior secondary education (Figure 2). 65% or 55 mothers work outside the home, while the remaining 35% or 30 are housewives (Figure 3). The results of this study describe the distribution of the respondent's character based on

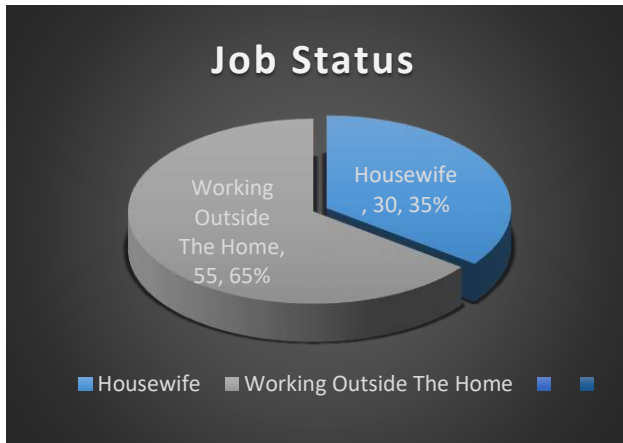
the mother's age range, education level, and employment status. Some of these variables are not related to maternal-fetal attachment scores. This is supported by several studies which state that there is no significant relationship between the variables of maternal age and education level on maternal-fetal attachment scores.



**Figure 1. Characteristics of respondent's age**



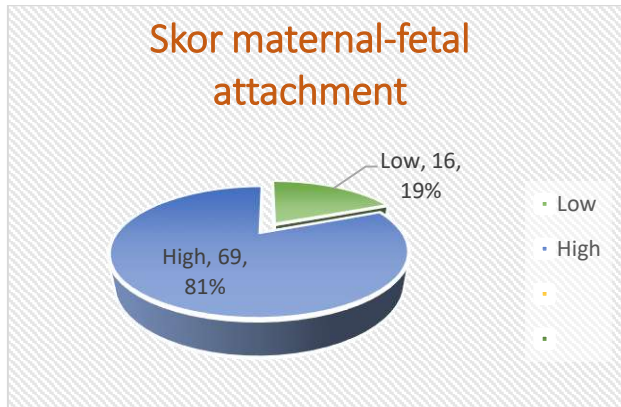
**Figure 2. Characteristics of education level**



**Figure3. Characteristics of employment status**

**Maternal-fetal attachment picture**

The results of the univariate analysis provided information that the majority of respondents had a high maternal-fetal attachment score, as many as 81% (69 people). Meanwhile, the respondents who had a low maternal-fetal attachment score were 19% (16 people). (Figure 4). There are various factors that support maternal-fetal attachment, including effective and efficient communication, information and education from health workers or midwives to patients. The midwife conveying the results of a careful and thorough head to toe physical examination is also suspected to be a factor that affects the maternal-fetal attachment score of the mother. Based on the researcher's observations, the midwife gave a comprehensive explanation, especially when examining the Leopold maneuver on pregnant women and involving her husband during the examination process.



**Figure 4: Overview of maternal-fetal attachment score**

This is also supported by previous studies which reported that the Leopold maneuver can help increase the bond between mother and fetus during pregnancy. [8]. In addition to communicating effectively and efficiently about the Leopold maneuver, IEC affects the bond between the mother and fetus during pregnancy. This is supported by Guney and Ucar (2019), who reported that the maternal-fetal attachment score in 55 pregnant women included in the IEC intervention group was higher than the number of pregnant women in the control group. Education on fetal movement during pregnancy visits or in classes for pregnant women to increase maternal-fetal attachment[9]. Another factor is antenatal care (ANC) will greatly affect the high maternal-fetal attachment score[10]. This is corroborated by the results of other studies that report that social support, in this case the husband, has a significant role in maternal-fetal attachment.

Another factor that may have contributed to the majority of the high maternal-fetal attachment scores at the Mlati II Public Health Center, Sleman, is the existence of classes for pregnant women which are routinely held and facilitated by midwives at the Mlati II Public Health Center. Maternal-fetal attachment is a new term in Indonesia, but the meaning of the concept has been integrated into the material for midwifery care. This is in accordance with the standard of midwifery service (SPK) which consists of normal pregnancy care which includes KIE [11]. Midwives at Puskesmas Mlati II hold classes for pregnant women once a week for one month, with the following materials: physiological changes of pregnant women, preparation for

childbirth, care for newborns, postpartum care, selection of contraceptives, and child birth certificates. This is stated in the regulation of the Minister of Health regarding standard material in the class of pregnant women [12]. Attributes regarding maternal-fetal attachment include talking or communicating with the fetus, stroking the mother's stomach as often as possible, preparing goods or needs for the prospective baby, preparing the name of the prospective baby. In addition, inviting the husband to communicate with the fetus in the mother's stomach is another attribute of the concept of maternal-fetal attachment that has been taught by the midwife at the Mlati II Public Health Center. Like research in general, this study has research limitations related to the limitation of the number of respondents so that it can affect the generalization of research results elsewhere in general.

### **Conclusion**

The majority of maternal-fetal attachment scores in pregnant women at the Mlati II Public Health Center are in the high category. Midwives directly and indirectly have integrated attributes that can support the high score of maternal-fetal attachment. Leopold examination, comprehensive KIE, partner involvement is known to increase maternal-fetal attachment. However, further research is needed on this relationship in future studies.

### **References**

- [1] Y. Sun *et al.*, "Effects of a prenatal yoga programme on the discomforts of pregnancy and maternal childbirth self-efficacy in Taiwan," *Midwifery*, vol. 26, no. 6, pp. e31–e36, 2010, doi: 10.1016/j.midw.2009.01.005.
- [2] Condon and Corkindale, "The correlates of antenatal attachment in pregnant women," *Br. J. Med. Psychol.*, vol. 70, no. 4, pp. 359–372., 1997, doi: 10.1111/j.2044-8341.1997.tb01912.x.
- [3] E. Abasi, H. Tahmasebi, M. Zafari, Gholamreza, and N. Takami, "Assessment on effective factors of maternal-fetal attachment in pregnant women," *Life Sci. J.*, vol. 9, no. 1 Supplemen., pp. 68–75, 2012, doi: 10.7537/marslsj0901s12.12.
- [4] E. K. Suryaningsih, "Indonesian Version of Prenatal Attachment Inventory (PAI): A Preliminary Study," National Taipei University of Nursing and Health Sciences, 2015.
- [5] W. Sukriani and E. K. Suryaningsih, "Factor contributed to The Maternal-Fetal Attachment," *J. Kesehat.*, vol. 9, pp. 185–191,

- 2018.
- [6] E. K. Suryaningsih, "Harmonisasi hubungan ibu dan anak," *kr.jogja.com*, Sep. 2016. .
  - [7] E. K. Suryaningsih, "The Association of Maternal-Fetal Attachment and Mother ' s Education Level Among Pregnant Women In Indonesia," in *International Conference on Health Science and Technology (ICHST)*, 2016, no. 63, pp. 435–439.
  - [8] M. Nishikawa and H. Sakakibara, "Effect of nursing intervention program using abdominal palpation of Leopold's maneuvers on maternal-fetal attachment," *Reprod. Health*, vol. 10, no. 1, p. 1, 2013, doi: 10.1186/1742-4755-10-12.
  - [9] E. Güney and T. Uçar, "Effect of the fetal movement count on maternal – fetal attachment," *Japan J. Nurs. Sci.*, vol. 16, pp. 71–79, 2019, doi: 10.1111/jjns.12214.
  - [10] F. Alvianty and E. . Suryaningsih, "Hubungan dukungan keluarga dengan matrenal-fetal attachment pada ibu hamil trimester III di Puskesmas Jetis kota Yogyakarta," Universitas 'Aisyiyah Yogyakarta, Yogyakarta, 2016.
  - [11] Permenkes, "standar asuhan kebidanan.pdf." Depeartemen Kesehatan, Jakarta, 2007.
  - [12] Misnity of Health, "Pedoman Umum Manajemen Kelas Ibu," 2009.

# MSMEs Empowerment Strategy in Rural Areas Facing The Society ERA 5.0

Endang Sungkawati<sup>26</sup>

## Introduction

Since March 2020 until now, the COVID-19 pandemic is still happening in Indonesia and has not shown a decline. The prolonged state of the COVID-19 pandemic has caused problems in various sectors, especially in the economic sector. Conditions that tend to be unstable have created turmoil, especially in the economic sector[1]. The high number of confirmed cases of Covid-19 has prompted the Indonesian government to issue a policy to impose restrictions on community activities. The confusion that occurred in the Indonesian economic sector was caused by a decrease in real national income caused by the minimal level of public consumption during the pandemic. The benchmark in economic development can be viewed through the quality and quantity of a country in managing the production of goods and services that affect the level of community welfare[2][3].

Based on the current situation that is being faced by the Indonesian people, it has a significant impact on the economy and has a direct impact on the sustainability of MSMEs[4]. In the face of a pandemic like today, the community and MSME actors are required to innovate more and be creative in selling their wares. Many MSME actors in the community have completely stopped their activities due to the absence of consumers, so people are looking for other activities that allow them to still be able to finance their lives in the midst of a pandemic like today[5]. Based on data from the Ministry of Cooperatives and Small and Medium Enterprises in March 2021, the number of MSMEs reached 64.2 million with a contribution to Gross Domestic Product of 61.07 percent or Rp. 8,573.89 trillion. MSMEs are able to absorb 97 percent of the total workforce, and can collect up to 60.42 percent of the total investment in Indonesia[6].

The presence of the industrial revolution 4.0 for MSMEs has provided challenges and opportunities for MSMEs in rural areas. The

---

<sup>26</sup> Wisnuwardhana University, [endang\\_sung@yahoo.co.id](mailto:endang_sung@yahoo.co.id)

view so far is that the existence of MSMEs is a small business that is unquestionable and able to withstand the shocks of the economic crisis and contribute to national development[7]. The presence of the industrial revolution has not been socialized and has not been adapted by MSMEs properly, now the existence of Society 5.0 has emerged[6]. The presence of the industrial revolution 4.0 and society 5.0 is expected to provide positive values for MSMEs to develop independently. The convenience of digital technology in the industrial revolution can be utilized by the community to develop MSME activities in rural areas that are far from urban areas and are not touched by communication technology infrastructure. The government through the Ministry of Communication and Information has launched a 2015-2019 Strategic Plan in the form of National Broadband connectivity, one of which is the Implementation of the Village and Regional Information System Application (SIDEKA) to 1000 villages. It is hoped that rural areas can be reached by communication technology so that the 4.0 industrial revolution provides opportunities for developing MSMEs and developing potential in villages, especially local wisdom[7]; [8].

Advances in information also cause rapid changes in various fields of life, especially science and technology. The description above has explained that globalization involves all countries, both developed and developing countries[2]. In fact, it has created an increasingly open world and interdependence between countries and between nations. In empowering MSMEs, a strategy for preparing economic empowerment for MSMEs is needed in facing the era of revolution society 5.0. The presence of the era of society 5.0 has the impact of intense competition, MSMEs must be able to overcome these challenges creatively, product innovation, marketing, product packaging, human resource development and technology[7].

The change in the era of the industrial revolution 4.0 to the era of society 5.0 cannot be done alone and immediately. Changing the situation must be done together with many parties. Through collaboration that allows a society to be able to continue to progress and develop[9]. There are certainly various models of cooperation between many parties, one of which is Penta-Helix. Collaboration in the Penta-Helix concept is a collaborative activity between fields and parties from Academic, Business, Community, Government, and Media or known as ABCGM. Likewise with the introduction of the era of society 5.0 to MSME actors, it is necessary to have ABCGM collaboration, especially MSMEs in rural areas which are still not



touched by information technology[10]. The Penta-Helix collaboration model aims to optimize the role of elements of Academics, Business, Community, Government, and Media as drivers of social change that can provide benefits to the community and the surrounding environment.

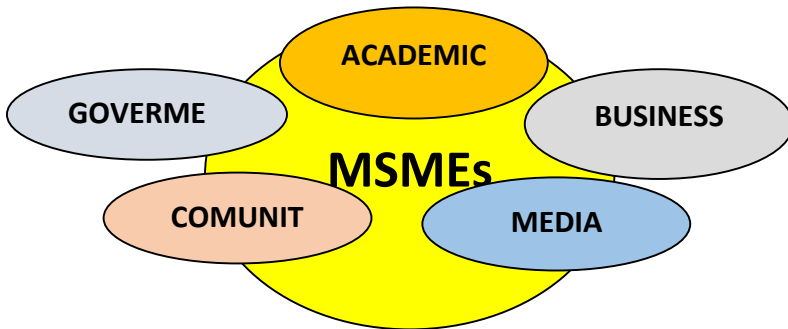
## **Discussion**

Strategy as a planning process by determining how the company or organization can achieve the desired goals[11]. The planning process includes the goal-setting process and the strategy-making process. Meanwhile, the notion of strategic management is the art and knowledge of formulating, implementing, and evaluating cross-functional decisions that enable an organization to achieve its goals[12]. According to this definition, strategic management focuses on efforts to integrate management, marketing, finance/accounting, production/organization, research and development, as well as manual and computerized information systems to achieve organizational success. Meanwhile, strategic management is a series of managerial decisions and actions that determine the company's performance in the long term[13]. Strategic management includes environmental monitoring, strategy formulation (strategic planning and long-term planning), strategy implementation, and evaluation and control. Strategic management emphasizes observing and evaluating environmental opportunities and threats by looking at the company's strengths and weaknesses [14].

Community empowerment comes from the term empowerment in the context of society, namely the ability of someone who is in the community and builds the empowerment of the community concerned [15]. Community empowerment is the elements that make it possible to survive and develop themselves and achieve progress. Empowering the community is an effort to increase the dignity of the layers of society who are in a condition unable to escape from backwardness and poverty [16]. Community Empowerment Community Empowerment according to RI Law no. 6 of 2014 concerning villages is empowerment, namely efforts to improve the standard of living and welfare of the village community through the establishment of policies, programs, and activities that are in accordance with the essence of the problem and priority needs of the village community. Community empowerment is basically a process of developing the potential and abilities of individuals/communities so that they strengthen their capacity, to

solve the problems they face so that they are able to fulfill their needs [17].

Industrial Revolution 4.0 Cyber Physical Systems is the connectivity of humans, data, and machines in virtual form. The rapid development of technology and information, including the presence of human jobs being replaced by the presence of intelligent robots, is considered to be able to degrade the role of humans [18]. This is the background of the birth of Society 5.0 [7]. The following is a description of the collaboration of various pentahelix components in community empowerment to prepare MSMEs in villages to face the Society 5.0 era [10].



**Image: Pentahelix MSMEs**

### **Academics**

The role of Academics (Universities) in Empowerment is to function to develop science and technology that better understand the changes in the industrial revolution era. In the tri dharma of higher education, namely education, research and carrying out community service, for example, empowering MSMEs to be competitive in the era of society 5.0. Academics in the context of social change can act as drafters[19]. For example, conducting research with the aim of assisting tourism village managers in identifying potential tourist attractions and business development opportunities in their area. Academics can also assist in increasing the knowledge and skills capacity of tourism village managers. Academics are a source of knowledge from the development of tourist villages that include the latest concepts, theories, and development models that are relevant to

the conditions of potential tourist attractions and business opportunities that exist in the village[17]. Higher Education with Education is able to educate the public in mastering science and technology and prepare students to be able to blend in with the community. Through research, universities can carry out studies on community problems that can improve the welfare of rural communities. Community service by universities contains elements: 1. Developing science and technology and art, 2. Disseminating science and technology and art 3. Applying science and technology and arts 4. Providing expertise assistance to the community 5. Providing counseling to the community 6. Providing services to the community [16].

### **Government**

The government in the context of social change must act as a regulator as well as a controller who has regulations and responsibilities in social change. In this case, the government's role involves all types of activities such as planning, implementation, monitoring, control, promotion, financial allocation, licensing, development and knowledge, public innovation policy, support for innovation networks, and partnerships between the public and private sectors[10]. The government also has a role as a coordinator for stakeholders who contribute to the social changes that the community wants to achieve. Through this concept, it is hoped that artificial intelligence will transform big data collected through the internet in all areas of life, with the hope of improving human abilities[7]. Through the Ministry of Communication and Information Technology launched the 2015-2019 Strategic Plan, namely in the form of National Broadband connectivity, one of which is the Implementation of the Village and Regional Information System Application (SIDEKA) to 1000 villages. The role of the government is expected to be able to drive the digital economy and present a digitalization system that is connected between MSME business actors. In addition to infrastructure, the main obstacles for MSMEs are the lack of access to capital, high credit interest and access to marketing[20]. Meanwhile, according to the common obstacles are limited working capital and investment, difficulties in marketing distribution and procurement of raw materials, limited access to information regarding market opportunities, low quality of human resources, technological capabilities, transportation costs, communication limitations, administrative procedures and complex

bureaucracy and uncertainty due to unclear economic regulations and policies [9].

### **Business**

Business or can also be referred to as the private sector in the context of developing MSMEs can act as an enabler. The private sector is an entity that carries out business processes in creating added value and maintaining sustainable growth. In this case, the private sector can act as an enabler in providing technology infrastructure, capital, and various other functions related to product development and marketing of goods and services produced by the community as the subject of social change itself[10]. The role of business in building institutions for the development of MSMEs is very important in encouraging MSMEs towards a productive economy. The involvement of Binsis is very much needed to meet the needs of community empowerment for MSMEs. The problems faced by MSMEs in the era of the Industrial Revolution 4.0 have brought changes in competitiveness with similar products, which can expand market share, increase income, and open up new jobs. Training is needed to gain additional knowledge about good products and production, commercial product packaging, new digital marketing networks in the era of Society 5.0. The need for empowerment carried out by businesses must be adapted to the challenges in the era of society 5.0. The role of business in building a productive economic business can be made a strategy to facilitate dialogue forums in order to synergize stakeholders[7].

### **Community**

In the context of social change, the community can act as an accelerator. In this case, the community is people who have the same interests and are relevant to the development of the potential to be developed[2]. Act as an intermediary or a liaison between stakeholders to assist the community in the overall process of social change and streamline the business process. In addition, the community also has a role to promote products or services produced by the community[21]; [2]. The community as an accelerator helps MSMEs in preparing for the era of Society 5.0 through socialization and also involving MSME actors in the introduction and marketing of their products[10].

## **Media**

Media in the context of developing a tourist village is also important because of its role as an expander. Media plays a role in supporting publications in the promotion of products and services produced by people who want to make social change[10]. Not only that, the media also serves to build a brand image from these social changes. So that other people can more easily access information about social changes that are being carried out by the community[9]. The ease of access to information then becomes one of the supporting factors for the arrival of new collaborators who can support the social changes that are being carried out by the community.

The use of the Penta-Helix collaboration model as a basis for collaborating in social development and change is very possible to create the sustainability of the social change desired by the community. Not only that, this social change can also provide benefits to the public at large, the surrounding environment, and the parties involved in the Penta-Helix scheme itself (ABCGM). So it can be concluded here that the synergy between the elements of Penta-Helix can be the key to the sustainability and sustainability of community development and positive social change desired by various parties.

## **Conclusion**

The following describes the MSME Empowerment Strategy in Rural Facing the Era of Society 5.0 which can be described in an interactive way the relationship between the roles of each component in the pentahelix which is expected to be able to contribute to the progress of MSMEs. As the main actors who are very important in the context of their own empowerment, it is hoped that the empowerment of MSMEs will provide motivation and benefits to face the era of Society 5.0. The MSME community is expected to strengthen its group in obtaining raw materials, production processes, and product sales. And the various facilities available to cooperative institutions will be felt by its members. The government's role in developing MSMEs and other institutions related to the empowerment of SMEs, such as cooperatives, associations, universities, and financial institutions, can be realized through policies that favor MSME business development. Universities have a role as business development consultants in various aspects, namely, management, production, market and marketing. And in the end, the synergy between academics, government, business, community and media is able to increase the

competitiveness of MSMEs and is expected to be able to become modern MSMEs and can compete in the era of Society 5.0.

## Reference

- [1] D. Gandasari and D. Dwidienawati, "Content Analysis of Social and Economic issues in Indonesian during the COVID-19 Pandemic," *Heliyon*, vol. 6, pp. 2–9, 2020.
- [2] E. Sungkawati, "Strategi Bertahan Pedagang Pasar di Masa Pandemi Covid 19," in *New Normal Kajian Multidisiplin*, Malang: Penerbit Psychology Forum, 2020, p. 529.
- [3] W. L. Hardilawati, "Strategi Bertahan UMKM di Tengah Pandemi Covid-19," *J. Akunt. dan Ekon.*, vol. 10, no. 1, pp. 89–98, 2020.
- [4] L. Kemenag, "Mendag: Omzet Pedagang Pasar Turun 39% akibat Covid-19." p. <https://economy.okezone.com/read/2020/06/01/320/22>, 2020.
- [5] M. N. A. Siddik, "Economic Stimulus for COVID-19 Pandemic and its Determinants Evidence from Cross - Country Analysis," *Heliyon*, vol. 6, pp. 1–10, 2020.
- [6] Kemenkeu, "Pemerintah Terus Perkuat UMKM Melalui Berbagai Bentuk Bantuan." 2021.
- [7] R. Hidayat and S. Andarini, "Strategi Pemberdayaan UMKM di Pedesaan Berbasis Kearifan Lokal di Era Industri 4.0 menuju Era Society 5.0," *J. Bisnis Indones.*, no. Edisi Khusus Pengabdian Masyarakat, pp. 93–109, 2019.
- [8] N. A. Setiawan and F. H. U., "Strategi Promosi dalam Pengembangan Pariwisata Lokal di Desa Wisata Jelekong," *Trikonomika*, vol. 13, no. 2, p. 184, 2014.
- [9] herwan A. Muhyi, A. Chan, I. Sukoco, and T. Herawaty, "The Penta Helix collaboration model in developing centers of flagship industry in Bandung city," *Rev. Integr. Bus. Econ. Res.*, vol. 6, no. 1, pp. 412–417, 2017.
- [10] N. S. Yunas, "Implementasi Konsep Penta Helix dalam Pengembangan Potensi Desa melalui Model Lumbung Ekonomi Desa di Provinsi Jawa Timur," *Matra Pembaruan*, vol. 3, no. 1, pp. 37–46, 2019.
- [11] Wahyuningsih, Husnah, R. Dg, Rahmatu, and Asngadi, "Strategic Management, Competitive Advantage and Community Empowerment," *Proc. 6th Int. Conf. Community Dev.*, vol. 349, pp. 599–602, 2019.
- [12] T. F. C. Satari and N. As'ad, "Strategy of Entrepreneurship &

- Creative Economy Development through District Mapping in Bandung City," *J. Vis. Art Des.*, vol. 10, no. 2, pp. 93–100, 2018.
- [13] D. Cravens, W. *Strategi Marketing*, Edisi 7. New York: The McGraw-Hill Companies, Inc., 2003.
- [14] I. Purwanto, *Manajemen Strategi*. Jakarta: Trama Widya, 2007.
- [15] Nurlela Kataren, "Faktor-faktor yang Mempengaruhi Keberhasilan Koperasi Credit Union dalam Pemberdayaan Masyarakat," *J. Harmon. Sos.*, vol. 1, no. 3, pp. 14–29, 2006.
- [16] E. Sungkawati., N. W. Suarniati, and Ratnawati, "Pemberdayaan Ekonomi Kreatif Masyarakat Melalui Kerajinan Batik Dan Pengemasan Produk Makanan Anggota Kopwan Intani Desa Bululawang Kecamatan Bakung Kabupaten Blitar," *Conf. Innov. Appl. Sci. Technol.*, vol. 2, no. 1, 2019.
- [17] Damayanti, M. S. S., and H. R., "Strategi Capacity Building Pemerintah Desa dalam Pengembangan Potensi Kampong Ekowisata Berbasis Masyarakat Lokal," *J. Adm. Publik*, vol. 2, no. 3, pp. 464–470, 2014.
- [18] E. D. Kuswadani and D. J. Damiri, "TRansformasi Sumber Daya Manusia Menghadapi Pasar Tenaga Kerja Era Revolusi Industri 4.0," *Kreatif*, vol. Kreatif, V, no. 1, pp. 91–103, 2020.
- [19] W. Sugeng, D. Indi, K. Amie, and S. Sri, "CREATIVE ECONOMIC DEVELOPMENT," vol. 01016, 2020.
- [20] J. Joehastanti, "Strategi Pemasaran Wisata Alam Untuk Meningkatkan Kunjungan Wisatawan Di Kawasan Wisata Kabupaten Kediri," *J. Revital.*, vol. 1, no. 2, pp. 61–73, 2012.
- [21] N. Setiyawan, S. Leksono, and E. Sungkawati., "Modal Sosial Pedagang Kaki Lima Dalam Memanfaatkan Ruang Publik Untuk Berjualan di Pasar Besar Malang," *J. Penelit. Pengkaj. Ilm. Mhs.*, vol. 1, no. 1, p. Universitas Wisnuwardhana Malang, 2020.

# Learning Assessment System in Islamic Higher Education

Enung Nugraha<sup>27</sup>

## Introduction

Equitable opportunities to continue education for the community are now increasingly open and expansive in universities, including Islamic universities. They are students of various backgrounds, one of which is the level of education or learning experience obtained previously, namely *madrasah aliyah* or Islamic boarding schools [1]. It has education characteristics in Indonesia that build an academic climate and the power of religion. In the student learning assessment system in higher education, there are differences from the previous level where active participation and independence of students are required in this case, while teaching lecturers to become guides and directors in achieving the learning objectives set [2]. Every student must understand the learning assessment system that the university has set to get learning outcomes that follow the seriousness and the learning process they take. The need for students to adapt to the higher education system makes it an obedient character academic and moral culture, which is an inseparable part of the soul of Muslim students.

In higher education, a learning assessment system is needed that aims to obtain, analyze and interpret data results about the process and learning outcomes of students systematically and continuously. It can be meaningful in decision through measurement and information on student competencies obtained from offline learning activities, structured assignments and unstructured independent activities [3]. As learning assessment system, the following steps are needed: developing and revising learning outcomes, designing outcome measures, collecting data, analyzing and evaluating data, writing assessment reports, and planning the next assessment cycle [4]. The assessment system applied will provide information and certainty to students about what and how to follow the assessment system to achieve good learning outcomes; this will provide feedback in good student perceptions. For this reason, proper assessment increases students' energy, ability, and confidence.

---

<sup>27</sup> Islamic State University of Banten



It can be objective, both in questions and comprehensive assessments, assessing all aspects of the student's personality; effectively and efficiently by providing feedback, ensuring timeliness and supervision in evaluating students' abilities [5].

Students' perceptions on an ongoing basis will be considered a significant factor in evaluating lecturers. The evaluations perceived by students towards lecturers' learning will have great potential for higher education as expected by students and provide sufficient information to improve lecturer quality learning [6]. Students' perceptions of the assessment system will provide positive support for their learning outcomes; of course, a better assessment system based on their perceptions will provide more significant opportunities to achieve better learning outcomes.

The lecturers who teach at universities that just grow and developed. So that it can lead to student prejudice, that lecturers are favorites. Interviews with individuals support the student's condition that giving a nominal value is inappropriate for the lecturer's assessment. Some students understand the material's content, but the value given is unsatisfactory. Some students rarely go to college and do not understand the teaching materials. However, also, students are not given enough motivation. Thus, the learning outcomes received by students can be said to be less objective and are considered unsatisfactory for students and are even said to get low grades to the detriment of the students themselves.

The important thing in the learning process is activities with the meaning of learning for students so that the learning outcomes they get can be helpful in their lives now and in the future [7]. One of the determining factors is the teaching and learning process to run as expected. Learning means a teaching and learning process that is expected for students to be directly involved in the learning process and get the results of their knowledge. Every student wants to get good or even excellent learning outcomes, regardless of their respective learning strategies. One crucial part of determining learning outcomes is the assessment system, which each lecturer, faculty, and university policies related to the applicable assessment system procedures [8]. For this reason, students as subjects in receiving learning outcomes need to know the applied assessment system.

## **Discussion**

### **Learning Assessment Level**

Assessing learning outcomes is the primary focus of assessment. Analyzing results can help determine what skills and knowledge students should demonstrate, in turn, guide what type or method of assessment, including academic abilities are communication, digital technology skills, information, ethics, and practicum to integrate these abilities with other learning outcomes [9].

In analyzing the learning system, students need to adjust to their level to become an assessment in higher education. Assessment in higher education is critical in measuring an institution's offering's educational effectiveness and quality. The learning assessment system helps students, lecturers, and employees respond to student development. It is necessary to have five levels of assessment achieved in higher education by exploring the importance of each level in achieving quality education [10].

### **Student Learning Assessment with Courses**

The first level looks at the assessment of learning with courses to measure student progress in learning with courses so that lecturers use formative and summative assessments that minimize assignments. In this case, an assessment using a pre-test or post-test to see changes for students taking courses.[10]. Thus, the skills and abilities of students with the course will provide a positive stimulus in the learning process and learning outcomes. It is natural to gain more comprehensive knowledge and experience, which provides a better quality of education.

### **Student Learning Assessment Without Course,**

The second level is to assess student learning during the course to measure student progress during lectures with the practical or program taken so that during the course, students achieve the following goals:

- Provide information on student progress during the course
- Provide actionable feedback
- Provide insight into the improvement of student learning on the program taken
- Delivering information on improving learning to improve the quality of education

To collect meaningful data, suggest that formative and summative assessments at this level answer the following three questions:

- Has student performance improved and met standards during the program or since entering college?
- How well do students achieve the disciplinary outcomes of the main program?
- How well do students achieve the institution's general learning outcomes over the four years?

### **Course Assessment**

The third-level assessment asks the program to evaluate the course effectiveness to help students achieve learning objectives. Preparing for the next course to acquire the expected skill level can help with formative and summative assessments. The assessments can identify curriculum improvements to increase educational relevance. Courses that match a cohesive pathway will improve teaching and course design [10]. Although assessing the course for students by increasing free time and costs, this is a sacrifice value in achieving the expected learning objectives. Thus, assessments sourced from courses have the advantage of showing the ability to answer summative or formative questions.

### **Program Assessment**

At the fourth level, an assessment involves a program that measures the alignment between curriculum design and learning objectives. Showing data collection that students have ready to achieve learning objective and explaining educational gap in curriculum with summative assessment by answering the following questions:

- Can that course program contributing to the outcomes set?
- How well is the lean program taken in achieving the curriculum objectives?
- How well do the sub-programs contribute to course objectives and learning?
- Is the program design in line with the expected results?
- Is the course organized coherently to achieve learning?
- Does the program advance learning objectives as plan?

The assessment practical program requires data collection at the start, middle program, and last program. Endpoint data is

invaluable as a summative indicator to knowing overall, is achieving its the objectives[11].

### **Institution Assessment**

The fifth assessment in higher education involves measuring the institution's effectiveness in educating students and preparing after graduation. The results are collected from institutional-level assessments to improve curriculum design and meet educational internal and external requirements. The lecturers and faculty were responsible for this program support as a systematic improvement in continuing education [12]. This process also allows stakeholders to close the loop between data assessment, analysis, and remediation efforts.

The implementation of improvements to the assessment system has increased the workload of lecturers, with a variety of activities to determine student progress and involvement in the assessment itself, both for lecturers and students [13]. In the case of students, the assimilation program plays an active role. They also feel stress and an extended workload, as well as the many tasks that must complete on a predetermined schedule [14].

### **Types of Learning in Higher Education**

Learning or learning has many dimensions including being easier to measure, on the other hand educational institutions are more pursuing vision and music in achieving teaching and learning [15]. There are some programs that are best at transmitting specific knowledge while others teach very general knowledge. There is no single comprehensive assessment of learning outcomes in higher education. In the assessment of learning outcomes all students are involved and can choose according to their goals [14]. Some ideas convey the typology of learning outcomes in higher education which aims to provide understanding, describe and classify learning outcomes so that different learning outcomes explain the disadvantages and advantages of using different outcomes as learning indicators.

Typology of Learning in tertiary institutions has become a classic for cognitive and non-cognitive approaches. The concept underlies the competencies that constitute most of the assessment activities. Universities as educational institutions must provide accountable and informative data about the quality of learning and teaching. However, higher education rankings can ignore information

on student learning outcomes so that they focus on research and learning outcomes, learning activities, published articles and the resources used. On the other hand, other indicators do not indicate the extent to which universities can develop their knowledge indicators [16].

### **Cognitive Outcome Approach**

Most of the assessments of learning outcomes have become necessary research in education, especially the assessment of cognitive learning outcomes [17]. Cognitive assessment broadly represents problem-solving skills, specific knowledge and general reasoning [18]. It becomes common knowledge in programs and courses and educational institutions by promoting general learning for all students [19]. Unfortunately, very little general content knowledge in tertiary institutions, so it is not sufficient to produce general education as an indicator of the quality of education. Cognitive skills assessment is a complex thinking process such as verbal and quantitative approach, information, understanding, operating analysis, problem-solving and evaluation [20]. There is some disagreement about whether such thought processing is generic and not field-specific.

### **Non-Cognitive Outcome Approach**

Non-cognitive development is about changing beliefs or developing specific values [21]. It has built a theoretical taxonomy and empirical results from non-cognitive higher education. Show that cognitive learning outcomes focus or not stage identity development theory [22]. These things explain that non-cognitive learning outcomes in higher education is more complicated than cognitive assessment. The measurement is indirectly essential on individual perceptions of facts, so the results may indicate student learning that is less objective than a measure of knowledge and skills. In addition, cognitive assessments serve as the basis for proactive outreach and interventions. However, non-cognitive assessments require students to self-report their responses to distort the results [23]. Thus, it is essential to determine whether non-cognitive assessment tools serve for social action reference

### **Conclusions,**

The learning assessment system in Islamic higher education is essential in realizing the applicable learning process and quality to

create competent human resources. In realizing this, it is necessary to build an integrated and multilevel assessment system to explain in making the best decisions for universities and students.

A level needs to determine how and how effective the system is in learning assessment by using student assessments with courses, student assessments without courses, course assessments, program assessments, and educational institution assessments. While learning in higher education uses a lot of cognitive and cognitive learning approaches, both of which aim to know the parameters of the learning they follow.

## References

- [1] M. F. Ashaari *et al.*, "An Assessment of Teaching and Learning Methodology in Islamic Studies," *Procedia - Soc. Behav. Sci.*, vol. 59, no. April 2014, pp. 618–626, 2012, doi: 10.1016/j.sbspro.2012.09.322.
- [2] P. E. Rawlusyk, "Assessment in Higher Education and Student Learning," *J. Instr. Pedagog.*, vol. 21, pp. 1–34, 2018, [Online]. Available: <http://www.aabri.com/copyright.html>.
- [3] M. Afif Amrulloh, "Sistem Penilaian Dalam Pembelajaran," *Al Bayan*, vol. 7, no. 2, pp. 125–138, 2015, doi: <https://doi.org/10.24042/albayan.v7i2.350>.
- [4] L. F. Gardiner, "Assessment Essentials: Planning, Implementing, and Improving Assessment in Higher Education (review)," *J. Higher Educ.*, vol. 73, no. 2, pp. 302–305, 2002, doi: 10.1353/jhe.2002.0019.
- [5] E. Nugraha, M. Akbar, and S. Supriyati, "Improving Learning Outcomes of Educational Research Methodology: Perceptions of the Assessment System, Learning Motivation and Emotional Intelligence among Indonesian Undergraduates," in *Proceedings of the First International Conference on Technology and Educational Science, ICSTES 2018, November 21-22 2018, Bali, Indonesia*, 2019, pp. 1–6, doi: 10.4108/eai.21-11-2018.2282021.
- [6] David Greatbatch and Jane Holland, "Teaching Quality Higher Education: Literature Review and Qualitative Research," Lndon, 2016. [Online]. Available: [https://www.researchgate.net/publication/312024245\\_Teaching\\_Quality\\_in\\_Higher\\_Education\\_Literature\\_Review\\_and\\_Qualitative\\_Research](https://www.researchgate.net/publication/312024245_Teaching_Quality_in_Higher_Education_Literature_Review_and_Qualitative_Research).
- [7] M. Peterson, D. Vaughan, and T. Perorazio, "Student assessment in higher education: A comparative study of seven institutions,"

- Ann Arbor, MI Univ. Michigan*, \ldots, 2001, [Online]. Available: <http://scholar.google.com/scholar?hl=en&btnG=Search&q=intitle:Student+Assessment+in+Higher+Education+:+A+Comparativ e+Study+of+Seven+Institutions#0>.
- [8] K. Tremblay, "Oecd assessment of higher education learning outcomes (ahelo): Rationale, challenges and initial insights from the feasibility study," *Model. Meas. Competencies High. Educ. Tasks Challenges*, vol. 1, pp. 113–126, 2013, doi: 10.1007/978-94-6091-867-4.
- [9] P. Ewell, "Applying Learning Outcomes Concepts to Higher Education: An Overview," in *National Center for Higher Education Management Systems (NCHEMS) This*, 2014, vol. 5, no. 2, pp. 40–51, [Online]. Available: [https://www.cetl.hku.hk/wp-content/uploads/2016/08/OBA\\_1st\\_report.pdf](https://www.cetl.hku.hk/wp-content/uploads/2016/08/OBA_1st_report.pdf).
- [10] A. Leskes and R. Miller, *Levels of assessment: From the students to the institution*. Washington, DC: AACU, 2005.
- [11] M. Wilson and K. Scalise, "Assessment to improve learning in higher education: The BEAR Assessment System," *High. Educ.*, vol. 52, no. 4, pp. 635–663, 2006, doi: 10.1007/s10734-004-7263-y.
- [12] K. M. Cauley *et al.*, "Assessment in Higher Education Assessment in Higher Education," *Pract. Assessment, Res. Eval.*, vol. 17, no. 4, pp. 1–11, 2015, [Online]. Available: [http://scholar.google.com/scholar?hl=en&btnG=Search&q=intitle:Structural+Decomposition+Techniques:+Sense+and+Sensitiv ity#0%5Cnhttp://www.who.int/hrh/resources/framework\\_action/en/%5Cnhttp://murraylib601.org/AuthenticAssessment.pdf%5Cnhttp://search.ebscoho](http://scholar.google.com/scholar?hl=en&btnG=Search&q=intitle:Structural+Decomposition+Techniques:+Sense+and+Sensitiv ity#0%5Cnhttp://www.who.int/hrh/resources/framework_action/en/%5Cnhttp://murraylib601.org/AuthenticAssessment.pdf%5Cnhttp://search.ebscoho).
- [13] D. Ribeiro Pereira and M. A. Flores, "Conceptions and Practices of Assessment in Higher Education: A Study of Portuguese University Teachers," *Rev. Iberoam. Evaluación Educ.*, vol. 9.1, no. 2016, pp. 9–29, 2016, doi: 10.15366/rie2016.9.1.001.
- [14] A. P. Check, *Student Learning Outcomes Assessment Handbook*. Youngstown State University, 2017.
- [15] F. Burrack and D. J. M. Thompson, "Assessment across an Institution of Higher Education," vol. 2, no. 1, pp. 1–19, 2021.
- [16] D. Nusche, "Assessment of learning outcomes in higher education: a comparative review of selected practices," *Innovación Educ.*, vol. 8, no. 45, pp. 36–77, 2008, doi: 10.1787/244257272573.
- [17] H. Nurani, F. P. Artharina, and . K., "Analisis Pelaksanaan

- Penilaian Kognitif Berbasis Kurikulum 2013 Sabiul Ulum Mayonglor Kabupaten Jepara," *Indones. J. Educ. Res. Rev.*, vol. 2, no. 2, p. 172, 2019, doi: 10.23887/ijerr.v2i2.17625.
- [18] R. J. Shavelson, "The Collegiate Learning Assessment," in *Forum for the Future of Higher Education*, 2008, no. March, pp. 44–69, doi: 10.1515/9780804773515-007.
- [19] K. Estrada-Orozco *et al.*, "Cognitive Assessment Test: Validation of a Short Cognitive Test for the Detection of Mild Cognitive Disorder," *Int. J. Alzheimers. Dis.*, vol. 2018, 2018, doi: 10.1155/2018/3280621.
- [20] X. Wei, N. Saab, and W. Admiraal, "Assessment of cognitive, behavioral, and affective learning outcomes in massive open online courses: A systematic literature review," *Comput. Educ.*, vol. 163, no. December, p. 104097, 2021, doi: 10.1016/j.compedu.2020.104097.
- [21] A. J. Metz, Q. Hu, A. R. Kelly, A. R. Fox, D. Shirley, and L. Shirley, "Non-Cognitive Assessment in Higher Education," *J. Coll. Orientation, Transition, Retent.*, vol. 22, no. 2, 2019, doi: 10.24926/jcotr.v22i2.2888.
- [22] L. M. Gutman and I. Schoon, "The impact of non-cognitive skills on outcomes for young people," *Inst. Educ.*, no. November, p. 57, 2013.
- [23] C. G. Davis, J. Thake, and N. Vilhena, "Social desirability biases in self-reported alcohol consumption and harms," *Addict. Behav.*, vol. 35, no. 4, pp. 302–311, 2010, doi: 10.1016/j.addbeh.2009.11.001.



# Midwifery Student Perception of Online Learning

Farida Kartini<sup>28</sup>

## Introduction

The COVID-19 pandemic has changed the order of life in various aspects, including in the field of education. The prohibition of crowds and the existence of a lockdown have resulted in limited activities and minimized travel unless absolutely necessary. The lockdown applies to all, including educational institutions. This causes schools and universities to not carry out their activities. This situation will have a very bad impact on the learning and teaching process. Therefore, breakthroughs are made so that the process can still run well. With the development of information technology as it is today, it is very easy to keep learning even though they have to lock down. The existence of the internet and applications that support and can be used as learning media are very helpful, especially in pandemic conditions like today. With the help of the internet and these applications, the learning process can still be carried out online. Thus, students still get learning by accessing learning from their respective homes.

The introduction of humans on the internet coincided with the introduction of computers to humans, namely in the era of society 4.0. On January 21, 2019, society 5.0 was inaugurated as an industrial resolution for industry 4.0 resolution. society 5.0 focuses on humans as its main component. Trying to recall the stages of society, namely stage I: society 1.0, stage II: society 2.0, stage III: society 3.0, stage IV: society 4.0, stage V: society 0.5. Society 1.0 is where at that time human life was in the era of hunting and recognizing writing. Society 2.0 is also referred to as the agricultural era where humans are familiar with farming. Society 3.0 where humans have entered the industrial era. At this time being have used machines to help with their daily activities. Society 4.0 where humans are familiar with computers to the internet. Society 5.0 is a refinement of society 4.0. Society 5.0 emphasizes that all technology is part of humans themselves. The internet is used not only as a means to share information, but more than that the internet is used to live life [1].

Currently the world is experiencing a COVID-19 pandemic and fortunately we are in the era of society 5.0. Thus, even if you stay at home, you can still connect with the outside world. This learning

---

<sup>28</sup> Universitas 'Aisyiyah Yogyakarta

model is also known as mobile learning (M learning). M learning is a learning model that utilizes wireless information technology [2]. Mobile learning is learning that utilizes wireless technology. Thus it is very possible that everyone can access information from anywhere and anytime [3]. Judging from the nature and function, learning using this technology is very profitable and promising. The learning method solutions offered during this pandemic are very good at first glance. The objectives of the learning process will be achieved properly. However, can learning using technology (online) always give results in accordance with what is expected?

Indonesia is an archipelagic country and geographically the condition of the plains is very varied. There are still a lot of remote and hard to reach areas. There are still many areas that have not been touched by electricity, let alone the internet. Let alone remote areas, there are still many areas that do not have these facilities. This condition becomes a very major problem in the implementation of online learning. It is stated that students who live in areas that do not have internet access cannot participate in online learning [4]. The uneven prosperity of people's lives also greatly affects the online learning process. Economic factors are also related to the number of children participating in online learning which greatly affects online learning itself. Limitations in having a gadget or computer, laptop plus the number of children who will use these facilities for online learning causes the learning process to fail. The most time for face-to-face online learning is during working hours. This causes many students who cannot participate in online learning. Parents of students generally work in the morning, while learning is done at the same time. This causes students to be unable to borrow their parents' gadgets for online learning [4].

Another problem in online learning is that the material delivered online cannot be understood by all students. The long duration of online learning causes students to be bored and lazy [4]. Midwifery education is education that is loaded with competencies that must be mastered by midwives. To achieve these competencies, it is done through learning in laboratory skills and in health service facilities. During the COVID-19 pandemic, learning in laboratory skills is carried out online, while learning in health care facilities is abolished. Based on this phenomenon, it is necessary to explore the experiences of midwifery students during online learning. This is very important considering that midwifery education is full of skills that

they must master. Therefore, it is necessary to know the experiences of midwifery students during online learning.

## **Discussion**

This article is the result of interviews with three midwives. One person is a midwife who has just graduated from midwifery diploma four and the other two are currently pursuing a master's degree in midwifery. The two midwives who are currently pursuing a master's degree are one of them a lecturer and the other is not yet working. The focus of selecting informants to be interviewed is those who have attended offline and online lectures so that they can distinguish the advantages and disadvantages of each of these learning methods. This topic really needs to be raised considering that midwifery education is an education that is full of practicum in laboratory skills as well as clinical practice. This interview was conducted to explore how they experienced online learning during this pandemic. Interviews were conducted in November 2021.

Interviews were stopped after getting data saturation. From the interviews, information was obtained about the advantages and disadvantages of online learning which were formulated in themes. The themes are economic aspects, focus on learning, social emotional aspects, learning styles, self-confidence.

### **1. Economic aspects.**

Online learning has both advantages and disadvantages. Online learning has considerable advantages both in terms of time as well as economic and resource aspects. Online learning can be done anytime and anywhere. This makes it very easy for those who live far from educational institutions. Economically, students do not need to pay fees, rent a place to live and also other costs needed if they have to take offline learning. Aspects of time, online learning provides breadth and flexibility of time for learners. Considering that sometimes there are events that coincide with online learning activities, so it is not possible to take online learning at that time, but they can still study the material at another time. Online learning when done with a focus will be effective in achieving learning materials. Distance learning or online until now is only effective in doing the tasks given by the teacher [5].

### **2. Focusing.**

Following online learning in a state of lack of focus or

unfocused will not get anything. If you don't focus on online learning, you can be sure that no material is absorbed at all. In contrast to offline learning, if you are not focused / not focused even though there is very little, there is still material that can be absorbed. However, online learning provides an opportunity to learn as widely as possible. With the tasks given trigger students to search for material or information as widely as possible on the internet. It is different when learning offline, looking for sources from the internet is not as active as when learning online. Students are responsible for themselves to explore new things and experiences that have not been previously obtained [6]. The informant also stated that online learning theory is still acceptable, even though the absorption is only about 50% when compared to offline learning. But for practical learning it is very difficult to understand. The assignments given to online learning make it difficult for parents and students, especially for parents who have never been familiar with gadgets. This is a burden for them [5].

### 3. Social emotional aspects.

The purpose of education is to make students become human beings who believe and fear God Almighty, have noble character, are healthy, knowledgeable, capable, creative, independent and become democratic and responsible citizens [7]. To achieve this goal, it is necessary to have a learning system that supports this direction. Direct face-to-face learning (conventional) that has been carried out so far has an impact not only on the cognitive aspect but also on the affective and psychomotor aspects. These three aspects are interrelated with each other. From the data obtained, that in online learning, these three aspects are less or not all of them can appear. The aspects that did not appear were related to the affective and psychomotor aspects. This aspect will develop when there is social contact when learning takes place. It was further stated that in online learning there was no interaction between fellow students and with teachers. Therefore, they cannot understand each other's characters. This will be very difficult in the association. This ignorance has an impact on how the relationship will be established. In other words, the social emotional aspect of a person cannot be honed well.

In socializing, one's social and emotional intelligence is needed. Good social and emotional intelligence will have an

impact on harmonious relationships. This emotional social intelligence will be well formed and can be learned when a person interacts/socializes with other people in direct contact. In online learning, there is socialization/interaction with one another, however, it does not happen directly. This situation is a gap. Online learning activities carried out by children during the COVID-19 pandemic greatly affect children's social and emotional development. Children's social emotional development is reduced due to lack of interaction with their peers. Children contact with their peers through online only so that children's lack of social sense with friends and their environment. Another impact is that children become bored, sad because they do not meet other people [8].

#### 4. Learning styles.

The learning style of one person with another is not the same. This learning style is closely related to the absorption of the material received. Online theory learning for some midwifery students if done in a focused manner can increase knowledge as well as offline learning. However, some students cannot even absorb lecture material. For practicum learning, the data obtained all show that online learning is not very effective for improving student skills. Learning style is a major capital so that individuals can absorb, organize and process the information they receive. In other words, the appropriate learning style is the key to individual success in learning. Visual learning style is a learning style through seeing, gazing or observing the object of learning. Auditory learning style is a learning style by prioritizing the senses of the listener. Kinesthetic is a learning style through physical activity and direct involvement such as handling, moving, touching and so on. The application of the combination of these learning styles or the application of these learning styles individually can improve learning achievement [9].

Studying at the Midwifery Study Program which has many learning skills makes it difficult for students to accept online learning. Learning skills acquired offline are much more mastered by students than online learning skills. Learning skills lab using videos is more effective than using modules [7]. Students who are given modules without seeing directly the skills that must be mastered are indeed very difficult. They will be very difficult to imagine, very different when the lessons are given by video. A well-prepared design of non-traditional laboratory

learning (online) is as effective as non-traditional laboratory learning [10]. In online learning, not all aspects to support learning styles can be met. This is very likely to have an impact on decreasing learning achievement, especially learning that requires skills.

5. Confidence.

Confidence in taking action is needed. Likewise, the self-confidence of midwifery students in applying their skills in providing care to patients. From the data, it was found that online laboratory skills learning could not provide good skills for midwifery students. This makes them feel less confident about their skills in providing midwifery care to patients. Previous research on pharmacy laboratory skills learning found that online practicum learning showed encouraging results. However, interaction between practitioners is lacking [11]. Other studies have found that online practicum learning is quite effective in increasing students' abilities in improving their practical abilities [12]. The difference in the data produced between this study and previous research is very likely due to different learning styles or due to other factors such as the readiness of students to participate in online practicum learning or other causes.

6. Internet signal

The problem that students often face in online learning is an inadequate signal. This greatly affects the absorption of learning materials and greatly reduces student interest in participating in learning. Not a few students in their area have signal difficulties or there is no internet signal, so to attend lectures they have to go to an area that has a signal with a fairly far distance, even then the signal is not necessarily adequate. Areas with minimal internet access experience obstacles in the teaching and learning process [6]. The availability of internet signal is closely related to the geographical situation in Indonesia. Indonesia is an archipelagic country with an unequal distribution of population which has an impact on the provision of internet services. Not all areas are covered by internet signals, especially in suburban and remote areas. This makes it very difficult for the people who live in the area if learning has to be given online.

## **Conclusion**

The perception of midwifery students towards online learning found that there were six themes, namely economic aspects,

concentration of attention, social emotional aspects, learning styles, self-confidence and internet signals. These themes are factors related to success in online learning. Economical aspect, providing convenience in terms of time and cost. However, online learning requires more attention so that to get good learning outcomes, a focused attitude is needed in learning. Online learning is less or unable to hone the social emotional aspects of students. So that online learning can improve learning achievement and skills, it is necessary to consider the learning styles of students. In learning laboratory skills for midwifery students, it is considered less effective. Online learning requires a good internet signal, the problem in Indonesia is that an unsupported internet signal is a big obstacle in this online learning.

## References

- [1] ----, "Mengenal Lebih Jauh Tentang Society 5.0," *Binus University*, 2021.
- [2] T. N. Aziz, *Strategi Pembelajaran Era Digital*, vol. 1, no. 2. 2019.
- [3] M. Ally, *Mobile Learning; Transforming the Delivery of Education and Training*. Canada: Athabasca University, 2009.
- [4] L. Efriana, "Problems of Online Learning during Covid-19 Pandemic in EFL Classroom and the Solution," *JELITA J. English Lang. Teach. Lit.*, vol. 2, no. 1, pp. 2721–1916, 2021.
- [5] R. Yunitasari and U. Hanifah, "Pengaruh Pembelajaran Daring terhadap Minat Belajar Siswa pada Masa COVID 19," *Edukatif J. Ilmu Pendidik.*, vol. 2, no. 3, pp. 232–243, 2020, doi: 10.31004/edukatif.v2i3.142.
- [6] N. Pakaya, F. A. Kida, and W. Atas, "Dampak Media Pembelajaran Online Pada Pendidikan Islam MTs Al Muhajirin Manado dalam Perspektif Psikologi Anak di Era Covid-19," *JIVA J. Behav. ...*, vol. 1, no. 2, pp. 71–75, 2020, [Online]. Available: <http://journal.iain-manado.ac.id/index.php/JIVA/article/view/1393>.
- [7] K. RI, *Kemenristekdikti*. Jakarta, 2003.
- [8] I. Abdiana and F. Mayar, "Analisis Pembelajaran Daring Terhadap Perkembangan Sosial Emosional Anak Usia Dini," vol. 5, pp. 7747–7750, 2021.
- [9] A. L. Bire, U. Geradus, and J. Bire, "Pengaruh Gaya Belajar Visual, Auditorial, Dan Kenestetik Terhadap Prestasi Belajar Siswa," *J. Kependidikan*, vol. 44, no. 168–174, 2014, [Online]. Available: <https://journal.uny.ac.id/index.php/jk/article/view/5307/4603>.

- [10] E. K. Faulconer and A. B. Gruss, "A Review to Weigh the Pros and Cons of Online, Remote, and Distance Science Laboratory Experiences," *Int. Rev. Res. Open Distrib. Learn.*, vol. 19, no. 2, pp. 155–168, 2018.
- [11] A. Nugroho, "Efektifitas Laboratorium Virtual Dalam Pembelajaran Praktikum Analisis Farmasi Pada Mahasiswa Farmasi Saat Pandemic Covid-19," *Refleks. Pembelajaran Inov.*, vol. 3, no. 1, pp. 317–324, 2021.
- [12] Nurhalimah, D. Fitriyuningsih, O. Haryati, and D. K. Rahayuningtyas, "Faktor-Faktor yang Mempengaruhi Efektifitas Praktik Laboratorium Daring Pada Masa Pandemi Covid-19," *JKEP*, vol. 6, no. 1, 2021.



# **Implications of Constitutional Court Decision No. 91/PUU-XVIII/2020 on Working Relationship with PKWT Reviewed from Legal Certainty**

Fithriatus Shalihah<sup>29</sup>

## **Introduction**

Law No. 11 of 2020 on Copyright Work is a Law that has accommodated several laws into one regulation [1]. Law No. 11 of 2020, which carries the concept of Omnibus Law, first appeared when Joko Widodo delivered his state of the nation address [2]. This Law has been passed and signed by President Joko Widodo on November 2, 2020. In its implementation, Law No. 11 of 2020 received many rejections from most Indonesian people [3]. The rejection is based on the argument that Work Copyright Law only regulates certain groups or groups [4]. In addition, the process of formulating Work Copyright Law is also considered to deviate from the rules of the establishment of legislation. So many people, especially academics, file a lawsuit or judicial review to the Constitutional Court.

The issuance of Constitutional Court Decision No. 91/PUU-VIII/2020 caused many polemics in the community, especially among academics. The Constitutional Court stated that the establishment of Law No. 11 of 2020 on Copyright Work is contrary to the Constitution of 1945. In addition, the Constitutional Court also considered that the Law is unconstitutional and requires revision. So that the Constitutional Court ordered the House of Representatives and the Government to improve Work Copyright Law within the next two years. In the 2-year grace period, the Constitutional Court declared Law No. 11 of 2020 on Copyright Work, and its derivative rules still apply. However, if no improvement is made within two years, Work Copyright Law becomes permanently unconstitutional. The Constitutional Court also stated that the government is prohibited from issuing new implementing regulations related to Work Copyright Law within the grace period of improvements that have been given.

The constitutional court's decision on Law No. 11 of 2020 certainly impacts Indonesia's legal certainty and climate efforts. The revision of this Law will significantly impact the certainty of the

---

<sup>29</sup> University of New Normal Abrugadabra

business world. Some disrupt industrial relations between employers and workers and related wage standards. The unconstitutional ruling declared by the Constitutional Court makes employers faced with the choice of using Government Regulation No. 35 of 2021 on Certain Working Time Agreements, Outsourcing, Working Time and Rest Periods, and Termination of Employment, and Government Regulation No. 36 of 2021 on Wages as a derivative rule of Work Copyright Law or not. One of the rulings states to suspend all actions/policies that are strategic and have a broad impact. It is not permissible to issue new implementing regulations relating to the Act. The constitutional court decision No. 91/PUU-VIII/2020 stated that the government and parliament were ordered to revise Law No. 11 of 2020 on Copyright Work.

If the legal basis alone must be revised, then the derivative rules must also be revised. This certainly causes legal uncertainty because it has been a year since November 2, 2020, Law No. 11 of 2020 was enacted. Some practices have changed as stipulated in the Act in the past year, one of which is employment relations. Previously. Regulations related to employment relations are regulated in Law No. 13 of 2003 on Employment. A working relationship is a legal relationship between an employer and a worker under an employment agreement [5]. The employment relationship begins after an employment agreement, which contains rights and obligations between workers and employers.

Employment agreements become the basis of employment relations. In addition to being regulated in Chapter 7 of Book III of the Civil Code, employment agreements are also regulated in Law No. 13 of 2003 on Employment. However, Law No. 11 of 2020 on Copyright Arrangements related to employment agreements refers to Work Copyright Law. Employment Agreements are distinguished in employment law are distinguished from Certain Time Work Agreements (PKWT) and Non-Specific Time Work Agreements (PKWTT) [6]. Law No. 13 of 2003 regulates the working period of workers with a specific time work agreement of a maximum of 3 years. Then, after the enactment of Work Copyright Law, the working period of workers with a Certain Time Work Agreement changed to a maximum of 5 years. Although this Law and the down rule are still valid for the next two years. However, implementing the employment relationship with workers in the Certain Time Work Agreement and the determination of the wage system confuses the use of legal bases related to specific time and wage agreements. This is because the

constitutional court's ruling is considered multi-interpretation, causing legal uncertainty in the community. From the above issues, the author tries to examine the issue of "The Implications of constitutional court decision No. 91/PUU-XVIII/2020 on employment relations with PKWT reviewed from legal certainty".

## **Discussion**

The Constitutional Court's decision No. 91/PUU-XVIII/2020 states that the establishment of Law No. 11 of 2020 on Copyright Work is contrary to the Constitution of 1945 and has no conditional binding legal force as long as it does not mean no improvements made within two years of this ruling is pronounced. To determine the product of a state institution is a binding legal product not solely determined by the political logic of representation [7]. Article 24C paragraph (1) of the Constitution of 1945 states that the constitutional court's decision is final, meaning that the constitutional court's decision has had permanent legal force since it was read out in the court's trial. Rulings that have the power of Law still have the binding legal power to be implemented.

Unlike ordinary court rulings that only bind each individual, the constitutional court's ruling in judicial review cases binds all state components, government, parliament, and citizens. In the case of law testing, what is tested is the norm of a comprehensive law. Although the basis for the application for the testing of the Act is the constitutional right of the aggrieved applicant, the purpose of this Act is to represent the legal interests of the entire society for the sake of upholding the constitution. It must be recognized that the constitutional court's decision above is a breakthrough. In addition, the ruling is likely to have a not simple impact in the future the application of the Principle of Legal Certainty in the Constitutional.

### **Court Decision No. 91/PUU-VIII/2020 Legal certainty can mean that a person will be able to achieve anything in the course of his life.**

Certainty is interpreted as the clarity of norms to make guidelines to the community subject to this regulation [8]. This understanding of certainty can be interpreted as clarity and firmness to the enactment of the Law in society. This is done to avoid any misinterpretation of the community. Legal certainty refers to the enactment of a law that is clear, fixed, and consistent in its implementation so that it cannot be influenced by subjective

circumstances [9]. Some elements support the realization of legal certainty, namely, legal substance, legal apparatus, and legal culture [10].

A rule must be made and promulgated definitively because it governs clearly and logically, clearly in the sense of not causing doubt (multi-interpretation) and logical. It becomes a system of norms with other norms that do not clash or cause a conflict of norms. The conflict of norms arising from the uncertainty of rules can take the form of norm contention, norm reduction, or norm distortion.

The Constitutional Court carved out a new history in the testing of the Law on November 25, 2021, by granting the testing of Law No. of 2020 on Copyright Work through 11Decision No. 91/PUU-VIII/2020. The Constitutional Court granted part of the petitioner's application in the ruling. In general, formal testing focuses on testing the procedure's suitability to establish an Act. However, in its development, there is an extension to the meaning of formal testing, which includes testing the conformity of the procedure for the establishment of the Act and relating to everything that is not material testing.

This procedural aspect is to realize three main functions: law enforcement functions, the implementation and application of Law, and the creation or formation of Law, including maintaining community participation [11]. So that this formal function is no less important than the material function of an Act. Therefore, its existence must be obeyed by the establishment of the Act or, in this case, the government and the House of Representatives.

In the decision No. 91/PUU-XVII/2020, the Constitutional Court emphasized the importance of the fullness of the formality of all stages of the formation of the Law and the meaningful participation of the community. The Constitutional Court then firmly stated that Law No. 11 of 2020 is flawed because its formation is not based on definite, standard, and standard methods and is not by the systematic formation of legislation.

In addition, there was a change in the writing of some substance after the joint agreement of the DPR and the President and conflicts with the principles of the establishment of laws and regulations. Against the ruling a quo, the Constitutional Court handed down the verdict unconstitutional conditional. The Constitutional Court does not directly cancel the enactment of Work Copyright Law. However, it delays its implementation by providing an opportunity for the Law to improve Work Copyright Law based on the procedures

for establishing laws that meet specific ways and methods, standards and standards, and the principles of establishing predetermined legislation.

The method of forming this Law must also be in line with the concept of the formation of the Act using the omnibus law method. So then, Work Copyright Law can be improved after establishing the legal foundation. However, in another ruling, the Constitutional Court gave a dilemma position. This is because the Constitutional Court still opens the scope for the implementation of Work Copyright Law as long as it is not related to matters of a strategic nature and broad impact, including the establishment of new implementing regulations, and does not become the basis for state organizers in carrying out strategic policies and broad impacts.

In addition, there is a gap in ambiguity to the meaning of "things that are strategic and have a broad impact," thus obscuring the meaning of what implementation actions can still be done under Law No. 11 of and what should not be done. Thus, the 2020 formal ruling against Work Copyright Law shows the anomaly of the verdict, on the one hand delaying the implementation of Law No. 11 of 2020. However, on the other hand, it still opens the scope for implementation and implementation of Law No. 11 of 2020. In my opinion, this further distances the spirit of realizing legal certainty brought by the Constitutional Court in deciding the testing of formal against Work Copyright Law and creates potential new legal problems at the level of its implementation.

### **Working Relationship with PKWT Based on Law No. 11 of 2020**

The Employment Agreement is an agreement in which the first party binds themselves to do a job for the other party by receiving wages [12]. Employment agreements are the foundation of the birth of legal relationships between workers and employers. In the Certain Time Work Agreement (PKWT), employers can create harmonious and dynamic working relationships as mandated by the Constitution of the Republic of Indonesia of 1945.

A specific time work agreement comes to fill a job with a time limit in its work and So that there is no arbitrariness of employers in the appointment of labor done through agreements in the form of a specific time work agreement to do work that is continuous or is a permanent worker in a business. In addition, certain time work agreements are also part of legal changes in the field of employment [13].

Changes to some provisions regarding employment in the Indonesian Omnibus Law contained in Law No. 11 of 2020 on Copyright Work drew much resistance from Workers. One of them is eliminating the maximum deadline of the PKWT, which has previously been expressly regulated in Law No. 13 of 2003 on Employment 2003

Under the old rules of the Employment Act, companies can only perform employment contracts of a specific time work agreement for a maximum of 3 years. After that, the company must appoint permanent workers to hire them after the past three years. While in Law No. 11 of 2020, the maximum deadline for certain time work agreements is submitted to the parties' agreement. In order to meet the demands of protection of legal certainty, then the derivative rules of Law No. 11 of 2020, namely Government Regulation No. 35 of 2021 on Certain Time Work Agreements, Outsourcing, Working Time and Rest Time, and Termination of Employment. They are stipulated in Article 6, which regulates the maximum time limit of a specific time work agreement to 5 years. As well Articles 8 and 9 governing the term of certain employment agreements also regulate the maximum limit of certain time work agreements for five years with the agreement of the parties, as well as the extension of certain time work agreements submitted to the parties with a maximum of five years calculated since the occurrence of the employment relationship. This will give space to be unfair to workers. Because after five years of being a contract worker there is no guarantee to be appointed as a permanent worker.

Furthermore, the provisions regarding compensation money provided to workers with certain time work agreements stipulated in the third section, articles 15, 16, and 17 of Government Regulation No. 35 of 2021 on Certain Time Work Agreements, Outsourcing, Work Time and Rest Time, and Termination of Employment. Article 15 states that the compensation money is entitled to be received by workers who work at least one month and are given after the expiration of a specific time work agreement. Article 16 regulates the proportional calculation of the compensation money received by workers. While article 17 regulates the obligation of employers to provide compensation money.

Government regulations serve as implementing regulations. Implementing regulations govern matters of a more particular nature in line with the Delegating Act. The need for harmonization and synchronization of implementing regulations with the above

regulations aims to provide conformity of substance of the content material in Law [14]. The decision of the Constitutional Court No. 91 / PUU-XVIII / 2020 states that the establishment of Law No. 11 of 2020 is contrary to the Constitution of the Republic of Indonesia year 1945 and does not have conditional binding legal force as long as it is not interpreted to be improved within two years, of course, causing many interpretations in which the author tries to interpret that the word does not have a conditional binding law in this regard. Although Law No. 11 of 2020 still applies, this Law and its rules do not have binding legal force. Before the establishment made any improvements to the Law. So there are many doubts about the decision issued by the Constitutional Court.

Suppose the employer has a working relationship with the worker in a specific working time agreement. Although Law No. 11 of 2020 applies or is no longer enforced, employers and workers can rule outlaws or regulations in conducting working relationships with certain time work agreements by using agreements made between 2 parties as a legal basis in employment relations, and it can be legal certainty for employers and workers. The legal principle of sideways action against the laws and regulations is commonly called *ius contra legem*.

### **Conclusion**

The issuance of Constitutional Court Decision No. 91/PUU-XVIII/2020 impacts Indonesia's legal certainty and climate efforts. The order to improve Law No. 11 of 2020 for the next two years will undoubtedly have a significant impact on the certainty of the business world. Some disrupt industrial relations between employers and workers with certain work agreements and related wage standards. However, in the working relationship between employers and workers with the PKWT, of course, it can be avoided by applying the principle of *ius contra legem*, where when the laws and regulations do not cause legal certainty, employers and workers, in this case, can rule out the laws and regulations with the agreements made by both parties to become the legal basis.

### **References**

- [1] M. Sjaiful, "Problematika Normatif Jaminan Hak-Hak Pekerja Dalam Undang-Undang Nomor 11 Tahun 2020 Tentang Cipta Kerja," *Media Iuris*, 2021, [Online]. Available: <https://www.e-journal.unair.ac.id/MI/article/view/22572>.

- [2] A. S. Prabowo, A. N. Triputra, Y. Junaidi, and ..., "Politik Hukum Omnibus Law di Indonesia," *Pamator ...*, 2020, [Online]. Available: <https://journal.trunojoyo.ac.id/pamator/article/view/6923>.
- [3] A. C. Nugroho and S. Syarifuddin, "Penolakan UU Cipta Kerja 2020 (Analisis Schoemacher & Reese Pemberitaan Cnnindonesia. Com)," *J. Komun. Korporasi ...*, 2021, [Online]. Available: <https://jasima.fisip-unmul.ac.id/site/index.php/jasima/article/view/24>.
- [4] N. Aprianti, M. A. Safa'at, and I. D. Qurbani, "Dualisme Model Pengujian Peraturan Daerah Pasca Undang-Undang Nomor 11 Tahun 2020 Tentang Cipta Kerja," *J. IUS Kaji. Huk. dan ...*, 2021, [Online]. Available: <https://www.jurnalius.ac.id/ojs/index.php/jurnaliUS/article/view/919>.
- [5] A. Sutedi, "Hukum Perburuhan." Sinar Grafika, 2009.
- [6] F. X. Djumaldji and M. SH, "Perjanjian kerja." Sinar Grafika, 2019.
- [7] M. A. Safa'at, "Kekuatan Mengikat dan Pelaksanaan Putusan MK," *Makalah, Malang Universitas Brawijaya*. [safaat.lecture.ub.ac.id](http://safaat.lecture.ub.ac.id), 2019, [Online]. Available: <http://safaat.lecture.ub.ac.id/files/2014/03/Kekuatan-Mengikat-dan-Pelaksanaan-Putusan-MK.pdf>.
- [8] T. Wijayanta, "Asas kepastian hukum, keadilan dan kemanfaatan dalam kaitannya dengan putusan kepailitan pengadilan niaga," *J. Din. Huk.*, 2014, [Online]. Available: <http://dinamikahukum.fh.unsoed.ac.id/index.php/JDH/article/view/291>.
- [9] F. K. Ismail, "Kepastian Hukum Atas Akta notaris Yang Berkaitan Dengan Pertanahan." Tesis Magister Hukum Fakultas ..., 2011.
- [10] L. M. Friedman, *A history of American Law*. [books.google.com](https://books.google.com), 2005.
- [11] J. Asshiddiqie, "Konstitusi dan konstitusionalisme Indonesia." Sinar Grafika, 2019.
- [12] F. Tampongangoy, "Penerapan Sistem Perjanjian Kerja Waktu Tertentu Di Indonesia," *Lex Adm.*, vol. 1, no. 1, pp. 146–158, 2013.
- [13] R. A. Azis, "Penerapan Perjanjian Kerja Waktu Tertentu (PKWT) Terhadap Pekerja Outsourcing Pasca Putusan MK No. 27/PUU-IX/2011," *Lex Jurnalica*, vol. 13, no. 3, p. 146534, 2016.
- [14] I. P. E. Cakra and A. Y. Sulistyawan, "Kompabilitas Penerapan Konsep Omnibus Law Dalam Sistem Hukum Indonesia," *CREPIDO*, vol. 2, no. 2, pp. 59–69, 2020.





# Dynamics of the Digitalization Era for Women Umkm Activitiest

Hamida Syari H Ari Sulistyanto<sup>30</sup>, Wichitra Yasa<sup>a</sup>, Nita Komala Dewi

## Introduction

Technological developments and the COVID-19 situation have brought changes to marketing strategies at the local level. The acceleration of digital alteration responds to the COVID-19 situation that is currently engulfing the world [1]. Improvement of the economy is a shared responsibility. Empowerment of women is expected to bring about changes in various aspects such as social, economic and political aspects [2], [3]. The number of heads of families affected by layoffs presents and improves women entrepreneurs in the context of food security and family health [4]. Therefore, women need to continue to innovate and understand market trends and are required to continue to innovate and understand market trends and master technology [5]. Digital marketing is a combination of interactive and integrated marketing so as to facilitate interaction between producers, market intermediaries, and candidates [1].

Micro Business is a productive business owned by individuals and/or individual business entities that meet the criteria for Micro Business as stipulated in this Law. Small Business is a productive economic business that stands alone, which is carried out by individuals or business entities that are not subsidiaries. or not a branch of a company that is owned, controlled, or becomes a part either directly or indirectly of a Medium or Large Business that meets the criteria of a Small Business as referred to in this Law. Medium Enterprises are productive economic businesses that stand alone, which are carried out by individuals or business entities that are not subsidiaries or branches of companies that are owned, controlled, or become a part either directly or indirectly with Small Businesses or Large Businesses with total net assets or annual sales proceeds as regulated in this Law [6].

Facing era 5.0 requires the readiness of UMKM activists to continue to adapt and adopt. Although the adaptation of UMKM in

---

<sup>30</sup> Fikom Universitas Bhayangkara Jakarta Raya,  
[Hamida.syari@dsn.ubharajaya.ac.id](mailto:Hamida.syari@dsn.ubharajaya.ac.id)

receiving, interpreting and translating internal disturbances that lead to their sustainability is quite good [7]. The results of the study indicate that the adoption of technological developments for women in using digital media is still low [8]. This is also confirmed that female UMKM actors who already have knowledge about e-commerce but have not been used as a way to face competition [9]. E-commerce and digital marketing are methods used by sellers in accelerating technology-based sales chains [10], [11]. Facing era 5.0 requires the readiness of UMKM activists to continue to adapt and adopt. Although the adaptation of UMKM in receiving, interpreting and translating internal disturbances that lead to their sustainability is quite good [7]. The results of the study indicate that the adoption of technological developments for women in using digital media is still low [8]. This is also confirmed that female UMKM actors who already have knowledge about e-commerce but have not been used as a way to face competition [9]. E-commerce and digital marketing are methods used by sellers in accelerating technology-based sales chains [10], [11]. Marketing using digital has changed marketing from one person to another, making it easier to reach potential customers and get better profits and investments [12]. Therefore, the selection of platforms on social media as well as content management is important in increasing sales [13].

Digital marketing or digital marketing is known as electronic marketing or internet marketing. Digital marketing is also a series of efforts in the form of strategies and tactics in achieving company goals [14]. Likewise, UMKM must be open to new breakthroughs. Business activities can take advantage of existing social media, but it is necessary to pay attention to the suitability of the character of consumers, products and the goals of the MSMEs themselves. Digital marketing makes it easy for business people to monitor and provide all the needs and desires of potential buyers. In addition, consumers can also search for and get products through cyberspace [15].

Empowerment of women in supporting development programs is urgently needed at this time. This effort is aimed at achieving equality in roles, access and control for both men and women. Empowerment programs are carried out in order to create and equalize the benefits of development itself. For this reason, various steps need to be taken to achieve gender equality. The results of the analysis show that the comparison of entrepreneurial competencies in terms of gender shows that men are more competitive in facing competition and are more forward-thinking in

business development, more situational in dealing with the dynamics that occur, while women are more willing to take risks and like to face challenges [16]. Technology and information become very important, especially in the context of gender equality. Women in their empowerment must gain access in obtaining information and the ability to apply information media for the achievement of sustainable development [2], [17]. This is the basis for this discussion, considering that there are still many acknowledgments or subordination to women's abilities and women's willingness to actualize their abilities.

The Community Association Communication Forum (FKRW) in Teluk Pucung Village, Bekasi is a forum and forum for friendship, communication that brings together the RW Management and Community Leaders in Teluk Pucung Village. The purpose of FKRW is to develop the quality of its members and the wider community in order to take an active role in national development, and to always maintain and preserve the unity and integrity of the nation through partnerships with the government, other social organizations and the entire community. FKRW Teluk pucung was established with the intention of uniting, accommodating and accommodating all community aspirations through community association entrepreneurs and community leaders and assisting the government in empowering and prospering the community. Although FKRW has become a forum for entrepreneurs, based on initial observations, business activities carried out so far are still very conventional, namely only participating in events or bazaars organized by the government or private companies (interview: Rachmad Adiiwibowo (Field of Cooperative and UMKM Development FKRW on 22 November 2021).

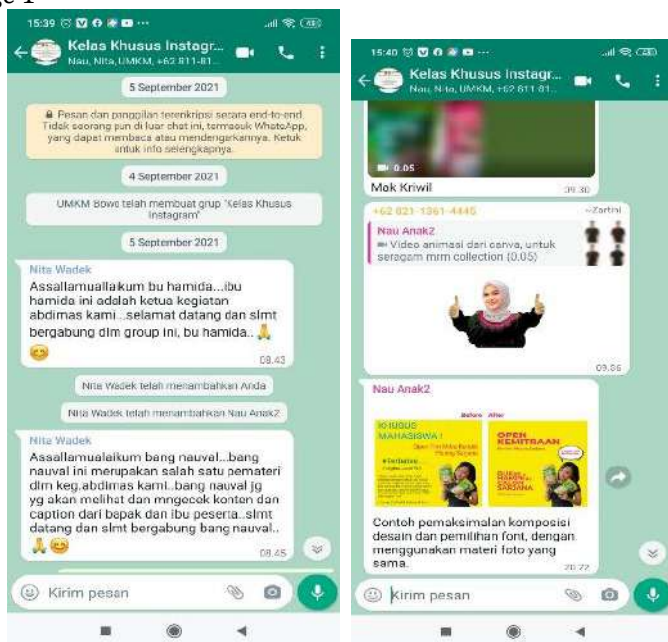
## **Discussion**

Empowerment is an activity to strengthen the power and empowerment of weak groups in society. As a goal, empowerment refers to the conditions or results to be achieved by social change, namely the community becomes empowered. Thus women's empowerment is to empower women who have been considered weak to be efficient and play an active role in development programs without eliminating their reproductive role [18], [19].

Digital marketing dissemination is a way to empower women to be efficient through knowledge and skills in the use of communication technology. Dissemination is also one of the FKRW programs in improving the quality of women UMKM in Pucung Bay.

The process of delivering information by FKRW is to provide knowledge, change attitudes and behavior of female UMKM actors. Dissemination of information delivered interactively about digital marketing is carried out in four stages over 3 days. The number of participants is 20 UMKM business actors in Pucung Bay. The first stage is providing knowledge related to innovation, namely digital marketing through Instagram Groups, the second stage is direct communication interaction in the form of material exposure and discussion. the third stage is the individual's decision is faced with a choice whether to accept or reject the innovation and the fourth stage is the confirmation stage where the individual will look for other sources of information that can strengthen the acceptance of the innovation [20]. The following captures the stages of dissemination activities carried out:

Stage 1



**Figure 1. Measuring informants' knowledge about digital marketing**

## Stage 2



**Figure 2. Dissemination of digital marketing**

Initial data shows that 75% of female UMKM actors do not understand digital marketing. Knowledge is obtained after direct communication between female UMKM actors and material providers. This means that there has been a communication interaction between the communicator and the communicant. As a result, as many as 85% of female UMKM participants increased their knowledge and understanding of digital marketing. The attitude of female UMKM actors towards the innovations submitted was 85% agree with the information submitted. This is indicated by the participants' interest in the information presented. At the decision-making stage, the informants were interested in changing the conventional way of trading to digital as much as 85% and asked how to change conventional trading to digital technology. The results of previous studies indicate that the use of the internet has an impact on increasing sales. Therefore, access, skills and motivation play an important role for women entrepreneurs in improving their businesses [21]. Other factors that motivate women to increase their businesses are family support, personal interests, job opportunities, technical knowledge, entrepreneurial experience, family background, and potential market [22].

Based on the results above, it shows that the motivation of female UMKM actors in Teluk Pucung UMKM is high in accepting innovation. The female UMKM actors agreed to obtain information related to digital marketing. Increasing the ability and self-concept of women by providing awareness and education through digital marketing dissemination also has an impact on increasing family welfare, especially during the COVID-19 period [23]. FKRW Teluk

Pucung Bekasi in this case is a forum that can motivate UMKM actors to continue to improve product knowledge and innovation. Digital marketing is one of the most effective ways to reach the target market on a person-to-person basis. Therefore, it is necessary to support various parties in increasing women's knowledge and skills in increasing their business. This support is embodied in the concept of gender equality where there is a division of roles and division of labor in both the domestic and public spheres [24], [25]

### **Conclusion**

Empowerment of women is one of the programs that support development. One of the supports for women in development programs is maintaining health and food security in the family, especially in the COVID-19 situation. The participation of the government and various stakeholders is needed in improving the quality and independence of Indonesian women. Gender equality will be achieved if all parties participate in providing justice in the implementation of roles and division of labor.

Dissemination is one of the gaps in empowering women so that they are more efficient in dealing with all situations. Women are efficient if they have the knowledge and skills to do entrepreneurship. Dissemination of digital technology to women, especially UMKM actors, needs to be increased in various regions in order to achieve a healthy and prosperous economy and also the realization of gender equality. Becoming an economically independent woman improves family welfare. For this reason, women need to always increase their knowledge and be sensitive to technological developments.

### **References**

- [1] N. M. Widnyani, N. L. P. S. Astitiani, and B. C. L. Putri, "Penerapan Transformasi Digital Pada Ukm Selama Pandemi Covid-19 Di Kota Denpasar," *J. Ilm. Manaj. dan Bisnis*, vol. 6, no. 1, pp. 79–87, 2021, doi: 10.38043/jimb.v6i1.3093.
- [2] R. Naneetha and M. Srihari, "A Case Study on Information and Communication Technology in Empowering the Visually Challenged Women in Inclusive Education," *Shanlax Int. J. Educ.*, vol. 9, no. 4, pp. 374–381, 2021, doi: 10.34293/education.v9i4.4208.
- [3] M. A. Aliansyah, "Memperkuat kewirausahaan melalui UMKM sebagai penopang laju pembangunan perekonomian," *HARKAT;Media Kmunikasi Islam Tentang Gend. dan Anak*, vol. 12,

- no. 2, pp. 171–179, 2016.
- [4] S. Y. R. Sanie and B. E. Prabawati, “Peran Pengusaha Perempuan UMKM dan Pola Pengeluaran Rumah Tangga pada Situasi Bencana Covid-19,” *J. Bisnis dan Manaj.*, vol. 8, no. 1, pp. 121–131, 2021, doi: 10.4103/jgid.jgid.
  - [5] A. Nurcahyani and M. F. Isbah, “Perempuan dan Ekonomi Digital: Peluang Kewirausahaan Baru dan Negosiasi Peran berbasis Gender,” *PALASTRENJ. Stud. Gend.*, vol. 13, no. 1, p. 27, 2020, doi: 10.21043/palastren.v13i1.6382.
  - [6] D. Rahmat, T. Yang, and M. Esa, “Undang-Undang Republik Indonesia Nomor 20 Tahun 2008,” no. 1, 2008.
  - [7] H. Respatiningsih, A. Arini, and B. Kurniawan, “MSME Adaptability In the Industrial Revolution Era 4.0 the Ability To Adapt Sme S in the Era of the Industrial,” vol. 16, no. 2, pp. 99–113, 2020, [Online]. Available: <http://akuntansiperpajakan.unw.ac.id/assets/images/penelitian/Bayu.pdf>.
  - [8] D. A. R. Widyastuti, R. Nuswantoro, and T. A. P. Sidhi, “Literasi Digital pada Perempuan Pelaku Usaha Produktif di Daerah Istimewa Yogyakarta,” *J. ASPIKOM*, vol. 3, no. 1, p. 1, 2016, doi: 10.24329/aspikom.v3i1.95.
  - [9] E. Kurniawati, J. Sosiologi, F. Ilmu, S. Universitas, and N. Malang, “Keputusan Perempuan Pemilik Umkm Jawa Timur Untuk Mengadopsi E-Commerce the Effect of Social Conditions on Decision Making of Women As Owners of East Java Msme To Adopt E-Commerce,” *J. Pendidik. Sociol. dan Humanis*, pp. 94–102, 2019.
  - [10] Mohammed T. Nuseir, “The Influence Of Digital Marketing Channels On The Consumer Buying Behavior: Moderating Role Of Marketing Strategies,” *Acad. Strateg. Manag. J.*, vol. 20, no. 8, 2021.
  - [11] Priyanka; Sadaf Siraj, “UNLOCKING THE PERSONALIZED-PRIVACY PARADOX: AN EMPIRICAL STUDY OF CUSTOMER INTENTION TO USE DIGITAL PERSONALIZED SERVICES,” vol. 20, no. 6, p. 6104, 2021.
  - [12] A. A. Alalwan, N. P. Rana, Y. K. Dwivedi, and R. Algharabat, “Social media in marketing: A review and analysis of the existing literature,” *Telemat. Informatics*, vol. 34, no. 7, pp. 1177–1190, 2017, doi: 10.1016/j.tele.2017.05.008.
  - [13] I. F. Maharani, D. Hidayat, and I. A. Dianita, “Penerapan Digital Marketing Pada Konteks Usaha Mikro Kecil Dan Menengah



- Womenpreneur," *J. Komun. Univ. Garut*, vol. 7, no. 2, pp. 699–709, 2021.
- [14] G. Minculete and P. Olar, "Approaches to the Modern Concept of Digital Marketing," *Int. Conf. KNOWLEDGE-BASED Organ.*, vol. 24, no. 2, pp. 63–69, 2018, doi: 10.1515/kbo-2018-0067.
- [15] D. Purwana, R. Rahmi, and S. Aditya, "Pemanfaatan Digital Marketing Bagi Usaha Mikro, Kecil, Dan Menengah (UMKM) Di Kelurahan Malaka Sari, Duren Sawit," *J. Pemberdaya. Masy. Madani*, vol. 1, no. 1, pp. 1–17, 2017, doi: 10.21009/jpmm.001.1.01.
- [16] [L. Studi, P. Umkm, and D. I. Kota, "Analisis Perbandingan Kemampuan Kewirausahaan Pengusaha Perempuan Dan Laki-," vol. 16, 2017.
- [17] H. Kerras, J. L. Sánchez-Navarro, E. I. López-Becerra, and M. D. de-Miguel Gómez, "The impact of the gender digital divide on sustainable development: Comparative analysis between the european union and the maghreb," *Sustain.*, vol. 12, no. 8, pp. 1–30, 2020, doi: 10.3390/SU12083347.
- [18] H. S. Harahap, "Pemberdayaan lurah perempuan dalam komunikasi pembangunan," *J. Makna*, vol. 1, no. September 2016, pp. 27–39, 2018.
- [19] A. V. S. Hubeis, *Pemberdayaan perempuan dari masa ke masa*. Bogor: IPB Press, 2010.
- [20] E. M. Rogers, *Diffusion of Innovations: Fifth Edition*, Fifth Edit. New York: Free Press, 2003.
- [21] F. I. Omar, S. A. Rahim, and N. A. Othman, "Internet use among women in business: Access, skill and motivations," *J. Komun. Malaysian J. Commun.*, vol. 33, no. 3, pp. 21–36, 2017, doi: 10.17576/jkmjc-2017-3303-02.
- [22] S. A. Irawati and B. Sudarsono, "Analisa Faktor-Faktor Yang Memotivasi Perempuan," *J. Ilmu Manaj. dan Bisnis*, vol. 6, no. 2, pp. 1–14, 2018.
- [23] I. Latipah, "Pemberdayaan Perempuan Melalui Pemanfaatan Media Youtube Dalam Meningkatkan Keterampilan Wirausaha," *Comm-Edu (Community Educ. Journal)*, vol. 3, no. 2, p. 83, 2020, doi: 10.22460/comm-edu.v3i2.4150.
- [24] H. S. Harahap, "Karakteristik Dan Pembagian Peran Produktif Dan Reproduksi Perempuan Lurah Di Wilayah Bekasi," " *J. Penyul. IPB*, vol. 16, no. 01, pp. 159–173, 2020, [Online]. Available: <https://jurnal.ipb.ac.id/index.php/jupe/article/view/3036>.

- [25] A. Rahmawaty, "Harmoni dalam Keluarga Perempuan karir :," *Palastren*, vol. 8, no. 1, pp. 1-34, 2015.

# Digital Marketing for Industrial Farming

Haris Hermawan

## Introduction

Quadruple Helix with Academic, Business, Citizens, Government (ABCG) involvement with using smartphones as a medium of communication and information, digitalization is spreading to various areas of the economy. This global trend has also affected the agricultural sector, which is the most conservative in relation to progressive technological developments, it is necessary to transform the way to market traditional industrial farming products to digital [1], for efficient farming [2], relationship quality for business [3], the characteristics of business to consumer relationship quality are customer centric, utilizing digital technology to manage information and communication, interactive, customer managed relationships, two-way customer relationships, consumer generated marketing, creating customer loyalty and retention, growing share of customers, building customer equity [4].

Maintaining customer satisfaction and retention of customer loyalty, depth of relationship by activating the use of the integrated concept of marketing communication in the customer ecosystem, so that customers are exposed to follow it [5], actions to meet individual needs- Acting to meet personal needs [6], positive perception-A psychological state confirming the intention to accept vulnerability based upon positive expectations of the intentions or behavior of another. This idea is the design and implementation of information-communication technology in society 5.0-based business management to empower smallholders to form industrial farming which is defined as a form of modern farming that refers to the industrialized production of livestock, poultry, fish, and crops. The methods of industrial agriculture are technoscientific, economic, and political. They include innovation in agricultural machinery and farming methods, genetic technology, techniques for achieving economies of scale in production, the creation of new markets for consumption, the application of patent protection to genetic information, and global trade [7].

Network marketing by utilizing digital technology platforms for human life to facilitate modern ways of communicating. The Telkom Agree application is a collaboration platform between actors, buyers, investors, and entities that support agricultural ecosystems.

Marketing Communication is part of business life in conducting transactions, marketing communication is needed as a means by which companies try to inform, persuade, and remind consumers directly or indirectly about the products and brands being sold. Marketing communications represent the "voice" of the company and its brand and are a means by which companies can establish dialogue and build relationships with consumers. The proposition that forms a new concept in this thinking is built from the basic theoretical model and previous empirical research to solve the marketing communication gap in business to customer relationship quality transform for industrial farming 5.0. The synthesis of this new concept of thought is rooted in the grand theory, namely consumer behavior theory [8], the commitment-trust theory of relationship marketing [9],

Howard and Sheth (1969) are researchers who first developed a theory of consumer behavior using a consumer behavior model, this model focuses on repeat purchases and describes the dynamics of buying behavior over a period, a person has motives, views, and can make decisions through a learning process, by making repeat purchases, the decision-making process becomes behavior (behavior) in the decision-making process into behavior customers need information and communication through media so that customers have an understanding of the brand from the incoming information. Howard and Sheth's model shows that the input (stimulus) is a stimulus that exists in the consumer environment consisting of commercial incentives from marketers and social incentives. Commercial incentives are significant incentives in the form of brands and symbolic stimuli related to the company's advertising activities. Social drive is word of mouth communication and occurs within families, social classes, and reference groups, is a very effective input for a purchasing decision.

Marketing communications for consumers, can tell or show consumers about how and why a product is used, by what kind of people, and where and when. Marketing communications contribute to brand equity by embedding the brand in memory and creating a brand image as well as driving sales and even influencing shareholder value, marketing communication aims to find, attract, retain, and grow target customers by creating, delivering, and communicating value advantages with customers while being tasked with maintaining loyal customers, maintaining customer loyalty means the company's ability to position its products in the minds of

customers and strive consider customers as partners by strengthening customer confidence, always interacting, if necessary developing for mutual progress. [10] states the characteristics of marketing communication: 1) influencing behavior, 2) starting with customers and prospective customers, 3) using one or all means to make "contacts", 4) trying to create synergies, 5) establishing relationships Internet, which stands for interconnection- networking, is an entire computer network that is interconnected using the standard Global Transmission Control Protocol/Internet Protocol Suite (TCP/IP) as a packet switching communication protocol to serve billions of users worldwide, currently has become a part of modern human life to communicate with each other, this is where the beginning of society 5.0.

Reviewing from this thought development scheme that the output to be produced is information and marketing communications, lies in the focus on the quality of the use of digital technology platforms where users have a shopping experience, including the experience of ease of transaction, then this thought is expected to be a thought that produces an outcome in the form of design. and implementation of information communication technology in business management. The proposition of thought that becomes the reference. Business-to-consumer relationship quality is the ability to act-skilled (skilled handling) owned by the company in quality, interactive relational relationships with actions to meet individual needs that contribute to creating positive customer perceptions so as to create a mutually beneficial relationship depth between the company and the company. customers for long-term customer loyalty [11].

Based on this background, it can be argued that the phenomenon of the existence of digital communication media that changes people's lives deserves to be studied, this is related to human life that cannot be separated from lifestyle and considering the rapid development and technological advances that bring the way of transacting to the point of finding new media. The existence of a digital technology platform as a modern technology in the form of a modern way of transacting in a customer environment that creates dynamics from social and digital cultural aspects, understands the basic meaning of lifestyle using modern methods, understands the intention of changing the way of transacting from traditional (offline) to become modern (online) that is integrated, has economic value, and is influenced by business activities, the problems obtained from the management information of smallholders.

1. Information is limited and has not touched smallholders;
2. Poor data collection;
3. Access to technology is still weak;
4. Insufficient availability of information sources;
5. The application of technological innovation requires a large investment capital.

**Discussion**

The purpose of this thought is constructed as a problem solver gap marketing communication in digital marketing for industrial farming 5.0.

1. Describe the limited information and sources of information that are lacking and have not touched smallholders;
2. Describe poor data collection and weak access to technology in interpreting digital technology platforms;
3. Formulate a marketing communication strategy model for the application of technological innovation for smallholder.

**Table 1 CRM Value Chain Table**

<b>Technology</b>	<b>Customer Portofolio Analysis</b>	<b>Customer Profile</b>	<b>Network Development</b>	<b>Value Proposition Development</b>	<b>Managing the Customer Lifecycle</b>
<b>Customers and Products</b>	Customer structure	Customer Profile	Customer management	Definition of pricing and product, customer rewards	Disability tracking
<b>Marketing</b>	Segmentation	Predictive modeling	Partner marketing development fund	Customization, promotion, competitive positioning	Promotion management, event management, email marketing
<b>Selling</b>	Forecasting	Historical data, earning analysis	Partner sales analysis	Sales methodology	Order, entry, order configurator, sales, company, web
<b>Service</b>	Cost to serve	Historical data, customer	Partner self service	Service level approval	shopping Service request management,

		satisfaction analysis			service ordering, self-services, field service
PRM	Partner recruitment	Partner portal	Partner management	Marketing development fund	Sales partner team
Other stakeholders			ERM, SRM, portal investor		Performance review
Analysis	Customer lifetime value, customer retention costs	Needs, customers, customer preferences, customer satisfaction	Partner performance	Pricing, profitability and incentives	Sales performance, service performance, balanced score card
Data Mining	Customer profitability analysis	Customer insight	Partner analysis		Customer displacement scoring, propensity to buy scoring
Activity-based costing	Cast modeling				The real cost

The marketing communication gap can be solved using customer relationship management with a value chain table for smallholder. The main steps to identify a CRM Value Chain are: Customer portfolio analysis is a customer interaction that is analyzed for potential and actual. Customer profile, is intimacy to recognize customers through: identity, history, expectations, and choices. Network development as a way to define, explain and manage relationships with network members within the company and stakeholders. Value proposition development is the creation of value sources for customers and a proposition and experience that meets their needs, expectations and preferences. Manage the customer life cycle from attention, interest, desire, action.

### Conclusion

The essence of digital marketing for smallholders is the traditional to digital transformation for industrial farming that involves netizens, while operational activities in business utilize digital applications for management in the form of multi-user and

multi-location management, transaction suspension, table management, product and price synchronization, customer loyalty management, product return management, promo management, inventory management, staff management, customer management,

## References

- [1] P. Kotler, H. Kartajaya, and I. Setiawan, *Marketing 4.0: Moving from Traditional to Digital*. John Wiley & Sons, Inc., Hoboken, New Jersey, 2017.
- [2] A. Mironkina, S. Kharitonov, A. Kuchumov, and A. Belokopytov, "Digital technologies for efficient farming," *IOP Conf. Ser. Earth Environ. Sci.*, vol. 578, no. 1, 2020, doi: 10.1088/1755-1315/578/1/012017.
- [3] Z. Lemma, K. Sripruetkiat, and ..., "Factors affecting sustainability of business relationships in ethiopia banana value chain," *J. Austrian Soc. Agric ...*, vol. 16, no. 05, pp. 83–95, 2020, [Online]. Available: <http://www.sagepublisher.com/volume/JASAE/16/5/factors-affecting-sustainability-of-business-relationships-in-ethiopia-banana-value-chain-5f1e8f7f9a30f.pdf>.
- [4] P. Kotler and G. Armstrong, "Principles of Marketing (14th ed.)," *Pearson Education, Inc., publishing as Prentice Hall, One Lake Street, Upper Saddle River, New Jersey*, 2012. .
- [5] Å. Finne and C. Grönroos, "Communication-in-use: customer-integrated marketing communication," *Eur. J. Mark.*, vol. 51, no. 3, pp. 445–463, 2017, doi: 10.1108/EJM-08-2015-0553.
- [6] M. Hollyoake, "The four pillars: Developing a 'bonded' business-to-business customer experience," *J. Database Mark. Cust. Strateg. Manag.*, vol. 16, no. 2, pp. 132–158, 2009, doi: 10.1057/dbm.2009.14. new world Encyclopedia, "Industrial agriculture," *new world encyclopedia*. 2021.
- [7] J. N. Sheth, "The Theory of Buyer Behavior," no. May, 2014, doi: 10.2307/2284311. [9] R. M. Morgan and S. D. Hunt, "The Commitment-Trust Theory of Relationship Marketing," *J. Mark.*, 1994, doi: 10.2307/1252308.
- [8] A. S. Terence, *Periklanan Promosi*. Jakarta: Penerbit Erlangga, 2003.
- [9] Haris Hermawan, Raden Andi Sularso, Diah Yulisetiari, "The Influence of Marketing Communication, Relationship Commitment, Business to Consumer Relationship Quality On Customer Loyalty in The Bread Industry," *Archaeol*.



*Egypt/Egyptology*, vol. 18, no.7, pp. 883–898, 2021, [Online].  
Available:  
<https://archives.palarch.nl/index.php/jae/article/view/7821>.  
*Concept and Tools*. Indonesia

# Work Experience and Work Achievement Effect on Lecturer's Career

Hary Murcahyanto<sup>31</sup>, Mohzana<sup>32</sup>, Adri Efferi<sup>33</sup>, Emilda Sulasmi<sup>34</sup>,  
Koidah<sup>35</sup>

## Introduction

Universities as institutions that serve the community need to improve themselves in all aspects of activities, so that later they can serve the community optimally. Universities from time to time are required to provide the best service to the community, both the community in the university such as lecturers, students, and management staff, as well as the general public who use universities.[1],[2][3].

Education at universities has the same function as companies, because education also produces something. produced by educational institutions are not goods, namely students.[4], [5], [6]. The educational process with its focus on learning activities is not the same as the process of processing raw materials into finished goods, or public services such as hospitals and transportation services. Education is a process to develop the potential, talents, interests, and intelligence of students.[3],[7],[8]. In the process of education and learning, students are not passive subjects, but customers who are actively undergoing learning.[9], [10],[11].

Learning is the activity of educators creating situations so that students can learn, students are not only passive target objects, only receive material from teaching staff, but should actively process, analyze, apply, and even develop innovative things.[12][13].Students as students and lecturers as educators both develop themselves, increase knowledge, skills, improve thinking skills, appreciate values, and others. Lecturers do not only act as providers of knowledge, but should function as drivers, supervisors, assessors and mentors in the learning process.[3], [6], [14], [15]In this case, the lecturer is a figure that can be imitated and imitated.

---

<sup>31</sup> Universitas Hamzanwadi, [harymurcahyanto@gmail.com](mailto:harymurcahyanto@gmail.com)

<sup>32</sup> Universitas Hamzanwadi, [mohzana@hamzanwadi.ac.id](mailto:mohzana@hamzanwadi.ac.id)

<sup>33</sup> IAIN Kudus<sup>3</sup> [adri.efferi@iainkudus.ac.id](mailto:adri.efferi@iainkudus.ac.id)

<sup>34</sup> Universitas Muhammadiyah Sumatra Utara. [emilda@umsu.ac.id](mailto:emilda@umsu.ac.id)

<sup>35</sup> IAIBBC Cirebon, [koidahk@gmail.com](mailto:koidahk@gmail.com)

Lecturers as said with inside the regulation on better training are professional: educators and scientists: with the primary task: of transforming, growing, and disseminating science, technology, and artwork via training, research, and network service.[16],[17],[18]. The improvement of academics is a middle a part of institutional improvement and consists of components of private improvement, expert improvement organizational improvement, and network improvement. The most important part of professional development is instructional development. Lecturer development requires the development of facilities and career development as part of organizational development, and welfare development as an important part of personal development.[19],[20],[21].

In educational institutions, a quality management system is needed, because in education, quality management is needed to regulate all educational activities and resources that are directed at satisfying customers.[22]–[24].The application of the concept of quality management in higher education requires various changes. But keep in mind that changes should stick to the right principles and rules. One form of change efforts made by universities is to conduct accreditation. Accreditation of higher education institutions is a comprehensive evaluation and assessment process of higher education commitments to the quality and capacity of the Tridharma program of higher education, as well as to determine the feasibility of educational units as a form of accountability to the community. At the higher education level, the implementation of accreditation is more intensive. Since the socialization of university accreditation, Hamzanwadi University is one of the accredited private Islamic universities. This institution is accredited. Based on the visitation and assessment carried out by the assessor team from the National Accreditation Board for Higher Education, Hamzanwadi University was declared accredited with a B grade.

One of the factors that caused this was the quality and quantity of human resources, both lecturers and education staff, which still needed to be improved. Judging from the ability of lecturers in carrying out teaching tasks in class, it cannot be categorized according to standards. One of the problems related to the service of lecturers to the community is the professionalism of the lecturers, when viewed from the work experience of lecturers, the age of permanent lecturers at Hamzanwadi University ranges from 27 to 63 years. Seventy lecturers are under 40 years old, seven people are 40 to 63 years old. If viewed from the experience gain, it can be stated

that work experience as a lecturer is only obtained at Hamzanwadi University. If on average they start their careers at the age of 25 years, then 70 lecturers only have a working period of 15 years, while 7 lecturers are over 15 years old. This data indicates that the experience of lecturers needs to be improved. In addition to having main duties in learning, a lecturer is expected to hold an important position in the management of the study program. Without sufficient experience a healthy study program is certainly difficult to realize, so it will take up a lot of time to complete the administration in preparation for accreditation. Procurement of instant data does not solve problems, but creates problems in the management of a university.

The management of ranks, related to materials and requirements for promotion, is managed professionally, lecturers should have experience in making credit score determinations and others, because this will make an important contribution to the smoothness of obtaining functional positions. Commitment, motivation, and a positive perception should begin to be grown by the lecturers. The teaching profession demands high commitment, motivation and a positive perception of their duties and responsibilities. This has a positive effect on career development and organizational success. Regarding work experience, the achievements of Hamzanwadi University lecturers have not met the desired expectations.

There are not many forms of work achievement to be proud of. So that in determining the position/position of the lecturer, the lecturer's achievements have not been considered. Lecturers still have difficulty in advancing to certain functional ranks, because some requirements, such as writing articles in accredited journals are still difficult, only a few lecturers obtain forms of research grants. There are no books written by lecturers printed by well-known publishers, moreover, innovative works related to technology and art are still very rare. The potentials of the lecturers above should be developed so that they can contribute more to the University, and so that they can be a motivation for other lecturers to have careers and achieve. The institution has also carried out a program to improve the competence of lecturers, such as coaching in the form of guidance by direct superiors, training, and workshops. Although some of these programs have been implemented, the quality and quantity of some programs need to be considered. Responding to problems regarding lecturers at the university, it appears that several aspects influence each other.

Lecturer career development, for example, can affect other aspects. Unsatisfactory achievements of lecturers, or undirected career development of lecturers can influence each other. The average experience of lecturers is still minimal, which can lead to sub-optimal performance. To answer some of these phenomena, serious and integrated attention is needed. Stating whether several variables or components synergize in realizing the quality and quantity of lecturers should be based on research activities so that the priority scale in lecturer development can be formulated properly in the institution's strategic plan, then this research is an effort for all of that. Based on the background and identification of problems, lecturer career development is limited to the implementation of academic supervision, experience, and work performance of permanent lecturers at Hamzanwadi University, East Lombok, West Nusa Tenggara.

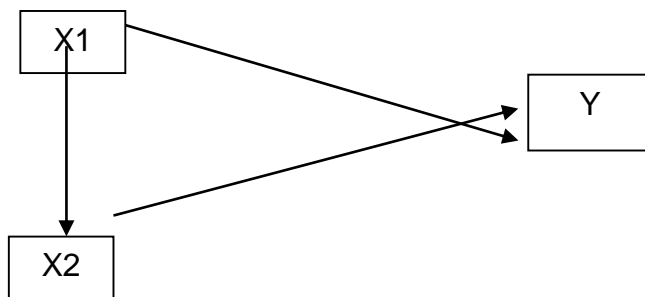
The lecturers in question are permanent lecturers, both those who already have an Lecturer Base Number and those who don't, both those who have been certified and those who have not. This research only focuses on the scope of influence, work experience, and work performance on the career development of lecturers at Hamzanwadi Pancor University, Selong District, East Lombok Regency, West Nusa Tenggara, for the 2020/2021 Academic Year.

### **Research Methods**

This observation targets to reap an outline of the impact of the implementation of labor level in and work overall performance at the careers of lecturers at Hamzanwadi University lecturers, (c) direct influence of work experience, on lecturers' work performance. This research was conducted at the Hamzanwadi University campus which is located on TGKH.M. Zainuddin Abdul Madjid street No. 132nd Pancor, Selong, Lombok Timur, Nusa Tenggara Barat Province. This research was carried out in 2 stages of distributing the instrument. Stage 1 was carried out in order to test the research instrument. Stage 2 was the actual research, the subjects of this research were permanent and non-permanent lecturers at Hamzanwadi University. This research is classified into the type of quantitative research with a path analysis approach, and the research method used is the field method through survey activities [25].

Based on the data obtained, the use of this method is expected to explain the effect of implementation, work experience, work performance on the professional development of lecturers. The

research design can be described as follows: Based on the above hypothesis, the hypothetical model is as follows:



Information :

X1 (Free Variable) = Work Experience

X2(Free Variable) = Work Achievement

Y (BondVariable) = Lecturer Career

The population of this study were all permanent and temporary employees and lecturers for the 2020/2021 academic year, totaling 160 people. This number consisted of 47 employees, and 112 permanent and non-permanent lecturers. The sample is part of the total population to be studied. From the 87 samples, 60 permanent lecturers were determined from the foundation that had NIDN, with the aim that the permanent lecturers had data related to this research. So the sample of this study was 60 lecturers. For the instrument trial, 30 lecturers were selected from a population that was not a sample.

The data analysis technique used in this research is descriptive and inferential analysis techniques. The use of path analysis was developed to study the direct and indirect effects of a number of hypothesized variables. Based on the theoretical framework that has been developed, there are 3 (three) variables studied in this study, namely work experience, work performance and career. There are 3 traits or necessities, namely: The facts for every variable is c language facts, the connection among variables is linear and additive, the connection among each variable is recursive (one way) residual variables aren't correlated with every: different and neither with variables withinside the system. Thus, the necessities taken a look at done earlier than checking out the speculation is the normality take a look at, linearity take a look at, direction analysis, and statistical hypotheses.

## **Results and Discussion**

### **Description of Research Data**

The first step in analyzing research data is to describe the data. The description of the data is done to obtain an overview of the condition of each research variable which includes the variables of work experience, work performance and lecturer's career. The endogenous variable in this study is the lecturer's career while the exogenous variables in this study are the Lecturer's Work Experience, Lecturer's Work Achievement. Lecturer careers are measured using 43 statement items, so the range of theoretical scores between 43 to 172 is 129. Based on the results of data collection, the lowest score is 69 and the highest is 166. This means that the empirical range of scores between 69 and 166 is 97.

The average career score is 111.20. With a median of 106.77 and a mode of 100.7. Based on the theoretical maximum score, it can be stated that the average score of the lecturer's career is 64.65% of the maximum theoretical score of 172. The standard deviation or standard deviation of the lecturer's career score is 24.92 and the variance is 62.10. The relatively large standard deviation value indicates that the diversity of lecturers' careers is relatively not uniform. Furthermore, if the lecturer's career score is grouped into a low category of 69-96, namely a medium score of 97-138, and a high score of 139-154, it can be stated that the lecturer's career conditions are as follows: the average score of a lecturer's career is 111.20, indicating that the lecturer's career Medium careers: 10 lecturers showed careers in the high category. This shows that most of the lecturers do careers in the medium category.

The work experience variable was measured using 41 statement items, so the range of theoretical scores between 41 and 164 was 123. Based on the results of data collection, it was known that the lowest score was 75 and the highest was 154. This means that the empirical range of scores between 75 and 54 is 79. The average value The average work experience score is 113.10 with a median of 109.87, and the mode is 106.21. based on the theoretical maximum score, it can be stated that the average work experience score is 70% of the theoretical maximum score of 164. The standard deviation or standard deviation of the work experience score is 17.83, and the variance is 317.73.

Furthermore, if the lecturers' work experience scores are grouped into the low category of 78-98, i.e. the average score is between 99-134, and the high score is 135-158, then the condition of

the work experience of the Hamzanwadi University lecturers can be stated as follows: the average score of the lecturer's work experience is 113,10, indicating that the work experience of the lecturers is in the medium category: as many as 11 the lecturers show the work experience in the high category. This shows that most of the lecturers have work experience that is categorized as moderate.

The work performance variable is measured using 45 statement items, so the theoretical score range between 45 and 180 is 135. Based on the results of data collection, it is known that the lowest score is 43 and the highest is 145. This means that the empirical range of scores between 43 and 145 is 102. The average value The average work performance score is 91.50 with a median of 86.43, and the mode is 77.5. based on the theoretical maximum score, it can be stated that the average work experience score is 51.03% of the theoretical maximum score of 180. The standard deviation or standard deviation of the work experience score is 27.39, and the variance is 750.26. Furthermore, if the lecturers' work performance scores are grouped into the low category of 43-87, that is, the average score is between 88-132, and the high score is 133-147, the condition of the lecturer's work performance can be stated as follows: the average score of the lecturer's work performance is 91, 50. This shows that most of the lecturers have moderate work performance.

### **Testing Requirements Analysis**

Path analysis requires that the analyzed data must meet certain statistical tests. Therefore, before conducting data analysis using a particular path analysis, first, several statistical tests are required in the path analysis.

### **Normality test**

Statistical test conducted to test normality in this study is the test formula. The hypotheses proposed in: the normality test are; H0: Data: comes from a population that is normally distributed, H1: Data comes from a population that is not normally distributed. The criteria in this test is if at the significant level = 0,05, then the data is normally distributed. Conversely, if  $L0 >$  at a significant level = 0,05, then the data is not normally distributed.

### **Test for normality of distribution Work experience**

After the normality test was carried out, the calculated  $X^2$  was 10.746. Then look for the  $X^2$  table at the 95% significance level



(confidence level) or = 0.05 and  $df = 7-1=6$ . Then  $X^2$  table = 12,592. So  $X^2$  count <  $X^2$  table or  $10,746 < 12,596$  so that the distribution of work experience data is normal.

**Distribution Normality Test Work Performance**

After the normality test, with the formula, the calculated  $X^2$  is 7.122. Then look for the  $X^2$  table at the 95% significance level (confidence level) or = 0.05 and  $df = 7-1=6$ . Then  $X^2$  table = 12,592. So  $X^2$  count <  $X^2$  table or  $7,122 < 12,596$ , so that the distribution of work performance data is declared normal.

**Normality Test of Career Variable Distribution**

After the normality test was carried out based on the  $X^2$  distribution table, with the formula, the calculated  $X^2$  was 7,578. Then look for the  $X^2$  table at the 95% significance level (confidence level) or = 0,05 and  $df = 7-1=6$ . Then  $X^2$  table = 12,592. So  $X^2$  count <  $X^2$  table or  $7.578 < 12,596$  so that the distribution of lecturer career data is declared normal.

**Linearity Test**

**Linearity test Career Work experience**

Calculation of estimates of simple linear regression models career variables and work experience. The results of the analysis of variance (ANAVA) on this model are presented in the following table:

**Table 1: Results of ANAVA for Significance and Linearity Tests**

Variant source	JK	RJK	Fcount	Ftable
Total	3786,68	3786,68		$\alpha=0,05$ $\epsilon=0,01$
Regresion (a)	724900,42	724900,42	1,618	2,025
Regresion (b)	23877,5	23877,5		1,825
(residual)	16361,08	282,09		
Match	12574,4	322,42		

Based on the calculation of the career linearity test on work experience, Fcount 1.618 is smaller than Ftable 2.025 at a significant level = 0.05, this indicates that the relationship between career and work experience is linear.

**Career linearity test on work performance**

The results of the analysis of variance (ANOVA) on this model are presented in the following table:

**Table 2: ANOVA Results for Significance and Linearity Tests**

Varia <span>nt</span> source			F <sub>count</sub>	F <sub>table</sub>	
Totally	4575,17	381,26		$\alpha=0,05$	$\alpha=0,01$
Regresion (a)	724900,42	724900,42	0,783	2,408	3,598
Regresion (b)	21933,86	21933,86			
residual	18304,72	315,59			
Match	13729,55	298,47			

Based on the calculation of the career linearity test on work performance, Fcount is 0.783 which is smaller than Ftable 2.408 at a significant level = 0.05, this indicates that the relationship between career and work performance is linear.

**Linearity test of work performance on work experience**

The results of the analysis of variance (ANOVA) on this model are presented in the following table:

**Table 2: ANOVA Results for Significance and Linearity Tests**

Variant source	JK	RJK	F <sub>count</sub>	F <sub>table</sub>	
Totally	5418,75	270,94		$\alpha=0,05$	$\alpha=0,01$
Regresion (a)	496132,27	496132,27	0,665	2,000	2,73
Regresion (b)	3525,31	35255,31			
(residual)	12268,42	211,53			
Match	9,67	,26			

Based on the calculation of the linearity test of work performance on work experience, Fcount of 0.665 is smaller than Ftable 2,000 at a significant level of = 0.05, this indicates that the relationship between work performance and work experience is linear.

## Hypothesis test

### Hypothesis 1.

Work experience has a direct positive effect on work performance. The tested hypotheses are as follows:

$$H_0 P_{21} \leq 0$$

$$H_1 P_{21} > 0$$

Based on the calculation results, the path coefficient value is  $P_{21} = 0,963$  with  $t_{ht} = 27,163$  and  $t_{tb} = 1,671$  at  $\alpha = 0,05$  or  $2,390$  at  $\alpha = 0,01$  because  $t_{ht} > t_{tb}$ , then  $H_0 : P_{21} \leq 0$  is rejected, and  $H_1 : P_{21} > 0$  is accepted, that the path coefficient  $P_{21} = 0.913$  is significant at the significance level  $\alpha = 0,05$  and  $\alpha = 0,05$ . By testing the acceptance of  $H_1$ , that work experience has a direct effect on work performance.

### Hypothesis 2.

Work experience has a direct positive effect on careers.

The tested hypotheses are as follows:

$$H_0 P_{31} \leq 0$$

$$H_1 P_{31} > 0$$

Based on the calculation results, the path coefficient value is  $P_{31} = 0,899$  with  $t_{ht} = 35,661$  and  $t_{tb} = 1,684$  at  $\alpha = 0,05$  or  $2,423$  at  $\alpha = 0,01$ , because  $t_{ht} > t_{tb}$ , then  $H_0 : P_{31} = 0$  is rejected, and  $H_1 : P_{31} > 0$  is accepted, that the path coefficient  $P_{31} = 0,899$  is significant at the significance level  $\alpha = 0,01$  and  $\alpha = 0,05$ , for that work experience has a direct positive effect on careers.

### Hypothesis 3.

Work performance has a direct positive effect on careers.

The tested hypotheses are as follows:

$$H_0 P_{32} \leq 0$$

$$H_1 P_{32} > 0$$

Based on the calculation results, the path coefficient value is  $P_{32} = 0,708$  with  $t_{ht} = 10,806$  and  $t_{tb} = 1,684$  at  $\alpha = 0,05$  or  $2,423$  at  $\alpha = 0,01$ , because  $t_{ht} > t_{tb}$ , then the path coefficient  $P_{32} = 0,708$  is significant at the significance level  $\alpha = 0,01$  and  $\alpha = 0,05$ . By testing the acceptance of  $H_1$ , that work performance has a direct effect on careers.

## Discussion

Based on the final model of the positive direct influence, work experience, and work performance on lecturer careers, the results of the study prove the three hypotheses proposed in discussing the effect

of work experience and work performance on the careers of lecturers at Hamzanwadi University. lecturers are closely related to leadership, work experience, work performance, organizational climate, competition, social relations, finance, education, promotion, even luck..

### **Work experience has a direct positive effect on Career**

Work experience has a direct positive effect on careers, the coefficient of influence is 0,899 or equivalent to the determinant coefficient of direct influence of 0,867. This shows that variations in work experience have a direct influence on careers by 8,67%. This illustrates that 8,67% of the career diversity of lecturers is influenced by variations in work experience such as meeting community needs, making meaningful contributions, being able to solve problems, and carrying out tasks well.

### **Work performance has a direct positive effect on Career**

Work performance has a direct positive effect on careers, the coefficient of influence is 0,708 or equivalent to the determinant coefficient of direct influence is 0,738. This shows that variations in work performance have a direct influence on careers of 7,38%. This illustrates that 7,38% of the career diversity of lecturers is influenced by variations in academic achievement, student development, creating innovative works, writing books, writing articles, research, community service and receiving awards for achievements from the government.

### **Work experience has a direct positive effect on work performance**

Work experience has a direct positive effect on work performance, the coefficient of influence is 0,963 or equivalent to the determinant coefficient of direct influence is 0,859. This shows that variations in work experience have a direct effect on work performance of 8,59%. This illustrates that 8,59% of the diversity of lecturers' work performance is influenced by variations in work experience such as meeting community needs, making meaningful contributions, being able to solve problems, carrying out tasks well.

### **Conclusion**

Based on the results of data analysis as described above, the findings and conclusions in this study can be stated as follows:

1. Has a direct effect on the career, this means that changes in the increase in work experience will lead to an increase in the career of lecturers.
2. Has a direct positive effect on a career, this means that changes in the increase in work performance will lead to an increase in the career of the lecturer.
3. Experience has a direct positive direct effect on work performance meaning that change in increasing work experience will have a direct effect on improving work performance.

Thus, in general, it can be concluded that variations that occur in the careers of lecturers at Hamzanwadi University are directly influenced positively by variations in supervision, work experience and work performance. This means that the career improvement of lecturers at Hamzanwadi University is caused by increased implementation, work experience and work performance.

## References

- [1] M. Mukhtar, S. Sudarmi, M. Wahyudi, and B. Burmansah, "The Information System Development Based on Knowledge Management in Higher Education Institution.," *Int. J. High. Educ.*, vol. 9, no. 3, pp. 98–108, 2020.
- [2] J. Simarmata *et al.*, *Pengantar Manajemen Sistem Informasi*. Yayasan Kita Menulis, 2020.
- [3] A. S. Ruky, *Sistem manajemen kinerja*. Gramedia Pustaka Utama, 2002.
- [4] B. Syukron, "Implementasi Manajemen Mutu Terpadu (Studi Transformasi Pada Perguruan Tinggi)," *J. Pendidik. Ekon. Dan Bisnis*, vol. 5, no. 1, pp. 51–62, 2017.
- [5] M. Arifin, "Strategi Manajemen perubahan dalam meningkatkan disiplin di perguruan tinggi," *EduTech J. Ilmu Pendidik. dan Ilmu Sos.*, vol. 3, no. 1, 2017.
- [6] R. N. Sudiyono *et al.*, "Meningkatkan Komitmen dan Kinerja Dosen: Apa Peran Manajemen Perguruan Tinggi?," *EduPsyCouns J. Educ. Psychol. Couns.*, vol. 2, no. 1, pp. 337–352, 2020.
- [7] J. Julyanthry *et al.*, *Manajemen Produksi dan Operasi*. Yayasan Kita Menulis, 2020.
- [8] S. Purba *et al.*, *Teori Manajemen Pendidikan*. Yayasan Kita Menulis, 2021.
- [9] P. Widiatmaka, "Kendala Pendidikan Kewarganegaraan dalam membangun karakter peserta didik di dalam proses

- pembelajaran," *J. Civ.*, vol. 13, no. 2, pp. 188–198, 2016.
- [10] M. S. Jailani and A. Hamid, "Pengembangan sumber belajar berbasis karakter peserta didik (ikhtiar optimalisasi proses pembelajaran pendidikan agama islam (PAI))," *J. Pendidik. Islam*, vol. 10, no. 2, pp. 176–192, 2016.
- [11] A. Kirom, "Peran guru dan peserta didik dalam proses pembelajaran berbasis multikultural," *J. Al-Murabbi*, vol. 3, no. 1, pp. 69–80, 2017.
- [12] S. Suryati, "Strategi Pembelajaran Seni Musik bagi Siswa Kelas XII SMA Muhammadiyah 2 Yogyakarta dengan Media Audio Visual," *PROMUSIKA J. Pengkajian, Penyajian, dan Pencipta. Musik*, vol. 4, no. 2, pp. 75–83, 2016.
- [13] D. J. Priansa, "Pengembangan Strategi & Model Pembelajaran: Inovatif, Kreatif, Dan Prestatif Dalam Memahami Peserta Didik," 2017.
- [14] N. N. Dewi, *Kiat-kiat Merangsang Kinerja Dosen PTS. MEDIA SAHABAT CENDEKIA*, 2019.
- [15] S. Nento, "Analisis Kompetensi Profesional dan Kinerja Dosen," *J. Ilm. Iqra'*, vol. 6, no. 1, 2018.
- [16] F. Mulyani, "Konsep Kompetensi Guru Dalam Undang-Undang Nomor 14 Tahun 2005 Tentang Guru Dan Dosen (Kajian Ilmu Pendidikan Islam)," *J. Pendidik. UNIGA*, vol. 3, no. 1, pp. 1–8, 2017.
- [17] H. Murcahyanto, M. Asmawi, and R. Madhakomala, "THE EFFECT OF DEMOCRATIC LEADERSHIP STYLE, ORGANIZATIONAL CULTURE COMMITMENT ON ORGANIZATION AND SELF-CONFIDENCE ON LECTURERS' PERFORMANCE OF STKIP HAMZANWADI SELONG LOMBOK TIMUR REGENCY," *J. Educ. Res. Adm. Manag.*, vol. 2, no. 1, pp. 176–184, 2018.
- [18] K. P. N. RI, "Undang-Undang RI No. 14 Tahun 2005 Tentang Guru dan Dosen," 2019.
- [19] J. T. Purba, "Strategi pengembangan dosen untuk menghadapi masyarakat ekonomi Asia tenggara: Studi kasus," in *Prosiding Seminar Nasional Ekonomi & Bisnis (SNEB) 2014*, 2014.
- [20] S. Sujarwo, "Pengembangan Dosen Berkelanjutan," *Makal. Perkuliahan Univ. Negeri Yogyakarta*, pp. 1–20, 2005.
- [21] M. Fahrurrozi, H. Murcahyanto, and M. Mohzana, "Produktivitas Kerja Dosen Dipengaruhi Kompetensi, Motivasi dan Pengalaman Kerja," *Alignment J. Adm. Educ. Manag.*, vol. 4, no. 1, pp. 31–42, 2021.
- [22] E. Firdaus *et al.*, *Manajemen Mutu Pendidikan*. Yayasan Kita Menulis, 2021.

- [23] A. T. Kuntoro, "Manajemen Mutu Pendidikan Islam," *J. Kependidikan*, vol. 7, no. 1, pp. 84–97, 2019.
- [24] M. K. Umam, "Dinamisasi Manajemen Mutu Perspektif Pendidikan Islam," *Al-Hikmah J. Kependidikan Dan Syariah*, vol. 8, no. 1, pp. 61–74, 2020.
- [25] S. Sugiyono, "Metode penelitian kuantitatif dan kualitatif dan R&D." Alfabeta Bandung, 2019.

## **Development of Traditional Music Learning Media Using Macromedia Flash 8**

Hary Murcahyanto<sup>36</sup>, Mohzana<sup>37</sup>, Farida Sani<sup>38</sup>

### **Introduction**

The development of information technology and the world of entertainment is growing rapidly, so that our students prefer to watch soap operas, movies, play games, the internet that will become their teacher rather than listen to the teacher's lessons in class. Therefore, today's teachers are required to create interesting and entertaining learning so as not to lose to information technology and the increasingly sophisticated world of entertainment.[1],[2],[3]. In accordance with the advancement of Educational Technology and Learning Technology, it demands the use of various learning media and increasingly sophisticated equipment.[4],[5].

In today's modern learning system, students not only act as recipients of messages, but students also act as communicators or messengers. In such conditions, what is called two-way communication and even multi-way communication occurs. The development of communication learning media is needed to increase the effectiveness of achieving learning objectives. [6],[7],[8],[3],[9]. That is, the learning process will occur if there is communication between the recipient of the message and the source or distributor of the message through the media.

The world of education is entering the era of the media world, in addition to learning activities, it demands the reduction of the lecture method and replaced by the use of many media. Especially in today's art learning activities which emphasize process skills and active learning, the role of learning media becomes increasingly important. [9],[2].

The use of media in the learning process is considered very important, namely in addition to supporting the teaching and learning process, it can also provide valuable and meaningful experiences for students.[8], [10]-[12]. To realize this, of course, creative and innovative teachers are needed in developing learning media, but they are still often found in schools that have not used learning media

---

<sup>36</sup> Universitas Hamzanwadi

<sup>37</sup> Universitas Hamzanwadi

<sup>38</sup> Universitas Hamzanwadi



optimally. Some teachers use more conventional methods in delivering subject matter.[7],[13],[4]. This is often found and occurs in schools that are far from urban areas, so that the learning process carried out is teacher centered learning, everything is only centered on the teacher, not from both parties, in this case a teacher and student, so that the content of learning that is accepted by students to be impressed passive. It would be better if in learning activities teachers and students could be more active, so that two-way communication took place and the learning content received by students could be more meaningful. The lack of use of media and the use of facilities available in schools causes the learning process to be one-way communication, only teacher-centered.[14],[12]. This is what happened at SMKN 1 Pringgasela, namely the lack of learning media for the teaching process in music extracurricular activities and limited space, as well as the lack of utilization of the facilities available at the school. Especially during the Covid-19 pandemic like what is happening right now.

The learning process in the midst of the Covid-19 pandemic, all learning is carried out online, of course as a teacher in carrying out this agreement it is required to be creative in providing learning to learning media carried out in schools.[9], [15]. Online learning is learning that is carried out using a variety of application media, including the Google Meet and Zoom applications. All of this was done, of course, as a way to prevent the spread of Covid-19. With this situation, of course, being a teacher or extracurricular coach is also required to be creative in making a learning media so that the learning or training process runs smoothly as usual.

With regard to the explanation above, the researcher is interested in researching more deeply about how to develop the Traditional Music Learning Media "Gendang Beleq" with Macromedia flash 8 at the Music Extracurricular at SMKN 1 Pringgasela, with the aim of facilitating the learning process or the exercises carried out. The benefits provide an understanding of the ease of using Macromedia Flash 8 in implementing the learning system.[1], [2], [16], [17].

Macromedia flash8 is a software program that functions to create two-dimensional animations that are very reliable compared to other programs. Its reliability is the small size of the animation file. Macromedia flash is not only used to create animations but is also used to create interactive menus, and as a learning medium.[16], [18]-[20].

Macromedia Flash is not easy to use, especially for beginners. In Macromedia Flash we have to memorize some commands to be able to make an attractive presentation. One of the drawbacks of the Flash application program is that a computer that wants to play flash animations must have a flash player, which must be installed online. Adobe Flash program does not use freeware.

## **Result and Discussion**

### **Product Development Results**

Based on the development procedure described earlier, in the process of developing audio-visual media using macro media flash 8 on Traditional Music "Gendang Beleg, there are several stages of development including the stage of needs analysis and product design analysis. Before carrying out the design of learning media development, the first step that must be done in this case is a field study (observation) and then a literature study. In needs analysis, it is necessary to identify problem analysis and media content analysis.

At the problem analysis stage, an investigation of the problems that arise in learning activities in the field is carried out and then identify possible solutions that can be used to overcome these problems. Based on the observations, it is known the following problems:

In the subjects of arts and culture (SBK) there are lessons that talk about the art of traditional dance. Then the traditional dance that is taught is the lady-in-waiting dance. In the learning process, this subject is more practical, it is necessary to develop learning media that are more creative and innovative but interactive

Students are less enthusiastic or less attentive when taking lessons, it is necessary to develop media that is attractive and interactive and has an attractive appearance so that students have the motivation and interest in learning to learn.

Lack of creativity of teachers in using learning media, causing students to feel bored.

The learning media still looks monotonous (lecture method)

The designed learning media is expected to improve student achievement and learning outcomes in traditional music extracurricular Gendang Beleg.

In the analysis of media content, the preparation of learning media requires an analysis of the learning objectives to be achieved and an analysis of the content of the media. The content of this learning media is referring to traditional music learning "Gendang

Beleq as traditional music in Lombok" At the Product Design Stage In the design process of learning media design using macromedia flash 8, in this case the display design needs a design sketch that is used to describe the manufacture of media. The sketch is formed in a storyboard. The sketch consists of:

1. Opening page view

On this page the screen will display photos of researchers who are used directly as models in this media. there is a loading icon which is used as the process of opening this media with the backsound directly using traditional Gendang Beleq music.

2. Menu Choice *Gendang Beleq*

On this page there is an animated image display of icons to make it interesting and there is a button between the icons is an icon that describes learning indicators, learning objectives, materials and finally an icon that describes quizzes. Here's a sketch of the menu options

3. Basic competency menu and indicators

This section will explain what the basic competencies and indicators for learning in traditional dance are taught. The following is an example of a sketch in this section. Menu of learning objectives This section contains the description of the learning objectives that are adjusted to the learning indicators and the basic competencies of the learning. The following is an example of a sketch in this section illustrate

4. Material Menu

This section contains material related to the traditional music playing technique of Gendang Beleq. In the explanation process related to the movement technique, it will be explained one by one which is practiced directly and then directly explain part of the game. The following is an example of a sketch in this section which can be illustrated as follows:

Menu "quiz" to evaluate the learning outcomes of traditional drumming beleq music which contains items related to the material that has been presented previously.

To start the quiz, participants must first fill in the identity column then in the password column write their name and then click the "start" menu to start the evaluation. To answer the quiz questions, participants just need to choose one answer that is considered correct, by clicking the ok button in the upper right corner and at the end of the quiz, the participant's score will appear automatically.

Profile section This section will explain the profile of the researcher clearly consisting of:

a) Implementation

The implementation process is the stage to realize the designs that have been previously made, where previously sketches or rough outlines are mapped into designs that are more real and suitable for use as learning media. In the implementation process, macromedia flash software is used because the tools panel in the software is very supportive for making animations, making buttons. The following are several pages of implementing traditional dance learning, for more details, please see the attachment page.

Implementation of the opening page display On the implementation of this page, the screen will display an animation of the title of the learning media, then a photo of the researcher who is used as a direct model in this study, then before starting on the main menu there is a loading icon which is given back sound using original music. The next menu starts when the moving icon on the loading icon on the video finishes playing.

Implementation on the Gendang Beleg menu section In this section is the initial menu before the start of learning begins. In this section there is a menu of choices including the learning indicators menu, learning objectives menu, material menu, quiz menu and finally the profile menu.

Implementation in the basic competence menu section This section is the initial menu for the learning process to begin, because the menu displayed in it contains the basic competencies of learning in traditional music learning, especially Gendang Beleg, there are two learning indicators in this section which can be seen directly in the original image displayed.

Implementation in the Learning Objectives Section. In this section there is a section on learning objectives. The learning objectives described are in accordance with what are the basic competencies in the learning. The following is the original image displayed on this learning media

Implementation in the material section In this section there are two parts, the first is a section that explains the main material, then in the second there is an explanation video related to the movement techniques in the dance. In this

section, the model used is a direct researcher, the goal is to organize the learning media created.

Implementation in the quiz section In this section, the evaluation and evaluation results are automatically filled in with the number of values obtained from the answers given to the questions presented.

From the original picture that was conveyed, first students were asked to fill in the name in the name column, then fill in the name as a password in the password section, then to start the quiz, just click the word "start". After the image appears, students just click on which answer is the most correct, after clicking it, then to start the next question, just click the "ok" button in the upper right corner. After answering all the questions provided in the quiz section, the last image appears. This section will display the results of the score after answering the questions provided. If a student gets a score above the standard passing grade, the column in the description section of the value result will automatically write the word "PASS"

b) Coding

Coding is a programming language used to execute commands to coded objects. In this system the programming language used is also called action script.

c) Test.

This stage is the stage where the learning media is examined. This stage is more about checking the navigation buttons for errors in giving orders, inaccessible navigation, checking for errors in the material, writing errors. This stage is checked by the maker and then checked by three media experts, and three material experts to ensure that the display design, programming, and learning materials are appropriate and suitable for use as learning media.

d) *Publishing*

This stage is the stage where the media design that has been created is exported from \*.fla files to \*.swf, and \*.exe files, to make it easier without having to install macromedia flash 8 software to open it. However, because to run the \*.swf file you need a flash player, the file used is the \*.exe file, but these two files will be included in the package in the form of a learning CD.

e) Packaging

At the packaging stage, the required files in the form of \*.swf or \*.exe are inserted into a folder. Then the folder is inserted into the CD.

### **The Effectiveness of Audio Visual Media Development Based on Macro Media Flash in Traditional Music Gendang Beleg**

Audio-visual development media using macro media flash 8 is a media that contains a tutorial on Gendang Beleg and its explanation. The development of audio-visual media using macro flash media is carried out as an effort to produce media products that are suitable for use in learning the art of music. This development research is a step used to produce media that can attract students' interest in learning to make students more enthusiastic in learning so as to improve students' abilities and understanding of multiplication and division material. In this development research using the Bord and Gall development model which has 10 stages which are simplified into 7 stages, namely: 1) Research and data collection stage, 2) Design planning, 3) Product development, 4) Expert validation test, 5) Product revision, 6) Field trials, 7) Final product revisions. Before the trial was conducted, the media was validated by 2 experts, namely 1 media expert and 1 material expert.

#### **Media Expert Validation**

The results of the media expert validation show validation from the media side of the "good" category and suitable for research with a total score of 56 with an average of 4. The assessment obtained can be detailed as follows: 1) The text can be read well and gets a score of 4 because each text on the slides are legible, 2) The media layer display gets a score of 4 because each layer doesn't watch, 3) The selection of background graphics gets a score of 4 because the colors used are in accordance with the theme, 4) Text size and typeface get a score of 4 because the typeface used matches the character. product titles and fonts used, 5) Illustrations, colors, supporting images get a score of 4 because they are in accordance with the product and material raised, 6) Animated presentations get a score of 4 because the animated characters used are in accordance with the developed product, 7) Video presentations get a score 4 due to the clarity of the display, the suitability of the video content with the product g is developed, 8) The sound is heard clearly and gets a score of 4 because each explanation of the type of motion in the delivery of the description sounds clear, 9) The carrying capacity of accompaniment

music gets a score of 4 because the music used is in accordance with the dance accompaniment, 10) The order of media presentation gets a score of 4 due to the delivery of the material explained in accordance with the order of the discussion, 11) Clarity of the description of the material gets a score of 4 due to the suitability of the content conveyed with the discussion, 12) Navigation gets a score of 4 because there is a match between the intended section, 13) Placement and use get a score of 4 because each part of the content of the material corresponds to the part of the content in the material, 14) Button gets a score of 4 due to the use of symbols in the suitability of linear material.

### **Material Expert Validation**

The validation results from the media show the validity of the material in the "Very good" category and is suitable for research with a total score of 60 with an average of 4. The assessment obtained can be detailed as follows: 1) the relevance of the material with the syllabus gets a score of 4 because it is in accordance with the material what is taught is traditional local dances, 2) the accuracy of the material with competency standards with a score of 4 due to the adjustment of the material with competency standards in the learning plan, 3) the sequence of presentation of the material gets a score of 4 because the learning process is carried out in accordance with what is shown in the order on the developed media, 4) the clarity of the structure presented gets a score of 4 because the explanation process carried out on the media developed is structured so that it is quickly understood by students and students, 5) The accuracy of the use of language gets a score of 4 because the explanation process carried out is in English. sa used which is easy to understand, 6) the support power of the learning program gets a score of 4 because the media developed is a media that everyone can learn, meaning that the level of difficulty can even be said to be non-existent, 7) the material in accordance with the formulated objectives gets a score of 4 because in the explanation process carried out between the existing material and the appropriate learning objectives, 8) the material in accordance with the student's ability to get a score of 4 due to the learning process carried out between the syllabus, basic competencies to the material being taught is a learning unit that has been adapted to students' abilities, 9) the material can be studied to get a score of 4, this is because the material being taught talks about regional dances, 10) The accuracy of the examples of images given for the clarity of the material gets a score of 4 due to visualization in the development of media

developed according to the examples of movement dance ladies-in-waiting, 11) Coverage of material related to the sub-themes discussed gets a score of 4 because the learning process is carried out with structured media developed, 12) Media according to the truth of the material gets a score of 4 because the media is developed based on the syllabus and plan learning that is made, 13) The material is easy to understand and gets a score of 4 because the grammar used can be understood by students, 14) The depth of the material presented gets a score of 4 because the material taught is adapted to the material about traditional dances of the local area, 15 ) The order of presentation of material from general to specific patterns gets a score of 4 because in the explanation given to the developed media, starting from understanding music in general, it is new to understanding music in its area.

After the validation results are obtained, further trials can be carried out. In this study, it was conducted at SMKN 1 Pringgasela during the field trial research, getting a score of 26.11 consisting of 17 students. In general, the use of macromedia flash 8-based audio-visual media is very effective because it can motivate students to enjoy learning dance. The motivation of students in learning regional dances is because the media developed besides explaining the name of the movement of each dance is directly exemplified or practiced by students and students, so that is what gives them the speed in learning the art of Gendang Beleq.

## **Conclusion**

Based on the results of research and discussion, it can be concluded as follows:

1. The process of developing traditional music based on Macromedia Flash 8 gendang beleq as a learning medium through four stages of development, namely analysis, design, development, implementation, and testing of learning media. At the problem analysis stage it was found that the score of the drum beleq music extracurricular students at SMKN 1 Pringgasela in learning gendang beleq music reached the KKM, the initial design stage used storyboards to facilitate the implementation of the design design, at the implementation stage of translating the design to the actual design using the Macromedia Flash 8 program. namely testing carried out by experts to check the validity and content of the material.



2. The feasibility of the traditional music learning media drum beleq as follows: a) The assessment of the feasibility of media experts is on average 92% in the very feasible category, b) Assessment of the feasibility of material experts on an average of 79.41% in the appropriate category. Thus, this learning media is appropriate to be used as a medium in the learning process.
3. Namely in the good category and very interesting to use as a learning media.

## References

- [1] I. Rizkiansyah and T. Sukardiyono, "Pengembangan Aplikasi Pembelajaran Interaktif Teknik Bermain Piano Berbasis Multimedia Di Lembaga Kursus Musik 'Ethnictro' Yogyakarta," *Univ. Negeri Yogyakarta*, 2013.
- [2] R. H. Wirasasmita and Y. K. Putra, "Pengembangan media pembelajaran video tutorial interaktif menggunakan aplikasi camtasia studio dan macromedia flash," *EDUMATIC J. Pendidik. Inform.*, vol. 1, no. 2, pp. 35–43, 2017.
- [3] H. Murcahyanto, M. Mohzana, and M. Fahrurrozi, "Dampak Media Sosial terhadap Kegiatan Kesenian Mahasiswa," *JOEAI J. Educ. Instr.*, vol. 4, no. 1, pp. 223–232, 2021.
- [4] D. P. Ikhwanudin, "Pengaruh Penggunaan Media Pembelajaran Trainer Elektronika Terhadap Hasil Belajar Mahasiswa pada Mata Kuliah Rangkaian Elektronika," *JUPITER (JURNAL Pendidik. Tek. ELEKTRO)*, vol. 3, no. 2, pp. 19–22, 2018.
- [5] D. J. Priansa, "Pengembangan Strategi & Model Pembelajaran: Inovatif, Kreatif, Dan Prestatif Dalam Memahami Peserta Didik," 2017.
- [6] G. Wahyu Wijaya, "Audiovisual Sebagai Media Pembelajaran Musik Daerah Di Kelas VIII D SMP N 3 Sewon Bantul Yogyakarta." Institut Seni Indonesia Yogyakarta, 2019.
- [7] D. Ridhayani, "Pengaruh Pemanfaatan Media Audio Visual Dalam Pembelajaran Seni Tari Terhadap Hasil Belajar Pada Siswa Kelas XI SMA Darussalam Medan." UNIMED, 2016.
- [8] D. A. Putri and Y. Sudarman, "PENGARUH PENGGUNAAN MEDIA AUDIOVISUAL TERHADAP HASIL BELAJAR SISWA PADA PEMBELAJARAN SENI BUDAYA (MUSIK) DI KELAS XI SMA N 1 2X11 ENAM LINGKUNG," *J. Sendratasik*, vol. 8, no. 3, pp. 52–62, 2020.

- [9] M. Mohzana, M. Fahrurrozi, and H. Murcahyanto, "Pengaruh Penggunaan E-Learning pada Mahasiswa," *JOEAI J. Educ. Instr.*, vol. 4, no. 1, pp. 233–242, 2021.
- [10] T. Hidayat, H. Rahmatan, and K. Khairil, "Pemanfaatan Media Pembelajaran Berbasis Internet pada Konsep Sistem Peredaran Darah Terhadap Hasil Belajar Kognitif Siswa pada SMA Negeri 1 Woyla," *Biot. J. Ilm. Biol. Teknol. dan Kependidikan*, vol. 4, no. 1, pp. 1–7, 2017.
- [11] G. Suryansyah, S. Jailani, and S. Y. Sari, "penerapan media pembelajaran berbasis internet dalam meningkatkan hasil belajar siswa Kelas V di madrasah ibtidaiyah nurul hidayah kota jambi." UIN Sulthan Thaha Saifuddin, 2019.
- [12] M. Abi Hamid *et al.*, *Media pembelajaran*. Yayasan Kita Menulis, 2020.
- [13] H. Murcahyanto, M. Fahrurrozi, and M. Mohzana, "Pengaruh Program Seniman Masuk Sekolah terhadap Motivasi Siswa," *JOEAI J. Educ. Instr.*, vol. 4, no. 1, pp. 215–222, 2021.
- [14] A. Arindah, "Pengaruh Penerapan Model Discovery Learning Terhadap Hasil Belajar Siswa Pada Mata Pelajaran IPS Kelas IV SD," *J. Penelit. Pendidik. Guru Sekol. Dasar*, vol. 3, no. 2, 2016.
- [15] F. Nadziroh, "The Analisa Efektifitas Sistem Pembelajaran Berbasis E-Learning," *J. Comput. Sci. Vis. Commun. Des.*, vol. 2, no. 1, pp. 1–14, 2017.
- [16] A. Malikhah, "Pengembangan media berbasis Macromedia Flash 8 untuk meningkatkan hasil belajar siswa pada mata pelajaran Bahasa Arab kelas IV di MI Mambaul Huda Banjarsari Ngajum Malang." Universitas Islam Negeri Maulana Malik Ibrahim, 2014.
- [17] D. B. Maritasari, *macro media flas 8*. selong: Universitas Hamzanwadi, 2016.
- [18] M. Mardhatillah and E. Trisdania, "Pengembangan Media Pembelajaran Berbasis Macromedia Flash Untuk Meningkatkan Kemampuan Membaca Siswa di SD Kelas II Negeri Paya Peunaga Kecamatan Meureubo," *Bina Gogik J. Ilm. Pendidik. Guru Sekol. Dasar*, vol. 5, no. 1, 2018.
- [19] M. S. M. Rahmi, M. A. Budiman, and A. Widyaningrum, "Pengembangan media pembelajaran interaktif macromedia flash 8 pada pembelajaran tematik tema pengalamanku," *Int. J. Elem. Educ.*, vol. 3, no. 2, pp. 178–185, 2019.
- [20] R. Alyusfitri, A. Ambiyar, I. Aziz, and D. Amdia, "Pengembangan Media Pembelajaran Berbasis Macromedia Flash 8 Dengan Pendekatan Contextual Teaching And Learning Pada Materi

Bangun Ruang Kelas V SD," *J. Cendekia J. Pendidik. Mat.*, vol. 4, no. 2, pp. 1281–1296, 2020.

## Spices Removal Heavy Metal Pollutants, Increase Ca and Protein in Foods

Hening Widowati<sup>39</sup>, Agus Sutanto<sup>40</sup>, Widya Sartika Sulistiani<sup>41</sup>,  
Evita Anggereini<sup>42</sup>, Maria Ulfah<sup>43</sup>, Merri Sri Hartati<sup>44</sup>, Asih  
Fitriana Dewi<sup>45</sup>

### Introduction

Public interest in *seafood* is increasing. This is supported because of the high nutrient content, especially protein and Ca. Crab and Shrimp are the most favorite products for seafood's fans. Beside the tasted that is delicious, crab and shrimp have a relatively affordable price compared to other marine products. As highly nutritious food, the lives of these two animals are important to pay attention to. Behind the deliciousness of this preparation, these two animals can survive in a polluted environment. As we known, the absorption of heavy metals before processing can be found in the meat. Research Widowati, et al [1] in ponds and around the Pasir Sakti mangrove environment, East Lampung, found that mangrove crabs absorb more metals than shrimp; on Cd absorption crab 576.42; Pb 497.51 ppb was much higher in absorption than shrimp, with Cd absorption 384.52; Pb 286.19 ppb. Likewise in research Anggraini, et al [2] and Susilawati, et al [3]. Although it is still far from the threshold, according to BPOM Indonesia Number 5 of 2018 [4] "the maximum limit of Cd in fish meat and fishery products such as crustaceans is 0.1 mg/kg, and Pb 0.2 mg/kg. kg".

The entry of Cd Pb into food can occur if the food grows and exists in a polluted environment. Together with other pollutants, heavy metals are discharged into the environment through industrial activity, automobile exhaust, heavy-duty electric power generators, municipal wastes, refuse burning, and pesticides used in agriculture [5]. Heavy metals Cd, Pb can be found in pond because in preparation

---

<sup>39</sup> UM Metro, [hwummetro@gmail.com](mailto:hwummetro@gmail.com)

<sup>40</sup> UM Metro, [sutanto11@gmail.com](mailto:sutanto11@gmail.com)

<sup>41</sup> UM Metro, [widya.sulistiyani@gmail.com](mailto:widya.sulistiyani@gmail.com)

<sup>42</sup> Jambi University, [Evita\\_pklh@yahoo.com](mailto:Evita_pklh@yahoo.com)

<sup>43</sup> Univ. PGRI Semarang, [mariaulfah@upgris.ac.id](mailto:mariaulfah@upgris.ac.id)

<sup>44</sup> UM Bengkulu, [merrisrihartati@umb.ac.id](mailto:merrisrihartati@umb.ac.id)

<sup>45</sup> IAIN Metro, [fitriana3003@gmail.com](mailto:fitriana3003@gmail.com)

for pond cultivation, fertilizer is applied to fertilize the soil and can grow microbes as natural shrimp foods. Anthropogenic environmental impacts (industry, agriculture, mining) significantly increase the naturally occurring amounts of heavy metals in the environment, including the marine ecosystem [6]. [5] The emergence of health problems in humans due to consuming agricultural products containing heavy metal ions such as cadmium (Cd) which is sourced from various types of agrochemical uses (fertilizers and pesticides) [7]. Furthermore, Kusumaningrum et al., [8], that urea fertilizer (TPS) contains 40-46% phosphate, NPK contains 15% phosphate, and the average Cd content in phosphate fertilizer is 138 mg Cd/kg". Other than being contaminated by Cd from the process of sowing urea fertilizer in ponds, urea can also be obtained from agricultural activities around ponds. Therefore, intensive shrimp ponds have the potential to be contaminated with cadmium metal (Cd) from the fertilization process in ponds and agriculture around the pond. Heavy metal contamination of lead (Pb) in traditional Pasir Sakti ponds mostly comes from pipes installed around ponds to replace water in ponds once a month and comes from exhaust gas from fisherman's small boats that use diesel or gasoline fuel. Sources of Pb contamination in traditional ponds far from mangroves can come from pipes installed as a substitute for pond water, from pesticides, insecticides, and molluscicides used in rice fields located near traditional ponds far from mangroves and plowing of fields using tractors with fuel. diesel also has the potential to pollute Pb in waters.

The discovery of heavy metals such as Cd, Pb, gives an indication, to be wary of. The nature of the bioaccumulation of Cd, Pb metals allows it to experience a continuous increase in the course of time. Crabs and shrimps have *non-selective filter feeder* properties, absorb everything in their environment, and live less active lives in an environment, which are the causes of massive discovery [9]. This situation allows accumulation in the body, so that it has the potential to be dangerous for consumers, if there is no strategy to anticipate and deal with it.

Various studies have shown that if you eat too many foods containing heavy metals, either in small or large amounts, it will have an effect on your health, considering that metals are accumulated in the body and are very difficult to break down. Cd entering the human body through food will settle in the kidneys and interfere with kidney function and can attack and damage the liver, testes, heart, brain, and human circulatory system, so it will interfere with health

[10]. Considering the dangers of consuming shrimp contaminated with Cd, therefore, the method of processing shrimp and crab must be considered, both when the shrimp and crab are still fresh, ready to be processed, or processed. Food processing by steaming, boiling, or sautéing, from several studies also significantly reduces heavy metals Cd, Pb. In a study by Widowati, et al [11] on clams, it can reduce to around 44.4% when boiled. By the same researcher [12], when compared between plant and animal food ingredients, there is a slight difference. Vegetable foodstuffs contaminated with heavy metals Cd, Pb will be easily reduced by frying processing, while animal foodstuffs are more easily reduced by boiling.

The effects of Pb poisoning will cause symptoms of a metallic taste in the mouth, black lines on the gums, GI disturbances, anorexia, vomiting, clicks, *encephalitis*, *wrist drop*, *irritability*, personality changes, paralysis, and blindness [13]. *Basophilic stippling* of red blood cells is a pathognomonic symptom for Pb poisoning. Other symptoms of this poisoning are anemia and *albuminuria*. Organic lead tends to cause *encephalopathy*. In acute poisoning, *meninges and cerebral* will occur, followed by stupor, coma, and death. High *cerebrospinal* (CSF) *liquor* pressure, insomnia, and *somnolence*.

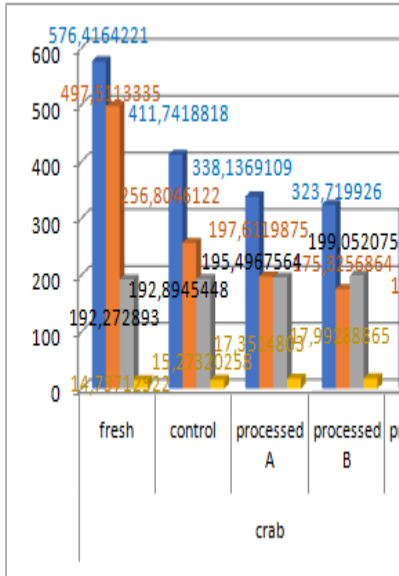
The problem of easy absorption of heavy metals in foodstuffs, including marine and pond products, which can harm consumers, it is absolutely necessary to carry out management including proper processing from preparation to processing/cooking so that it is expected to be safe and healthy when consumed. The community culture to get rid of fishy/rancid, used natural fruit acids, either in the form of lime, tamarind, lemon, pineapple, starfruit. The ingredients that have been given acid are then washed, and processed with spices to produce delicious foods.

Based on these problems, a study was conducted with the aim of: 1) Knowing whether or not the use of processed spices had an effect on reducing Cd Pb levels, while maintaining Ca and protein levels in mud crabs and shrimps; 2) Knowing the use of the best processed food spices that can reduce Cd, Pb, while maintaining their nutritional levels; 3) Knowing the contribution of types of seafood/pond that have a great opportunity to absorb heavy metals; 4) Knowing the contribution of spices to reduce Cd, Pb metals in food processing; 5) Knowing other positive effects, namely on nutritional levels, the use of spices in processed foods.

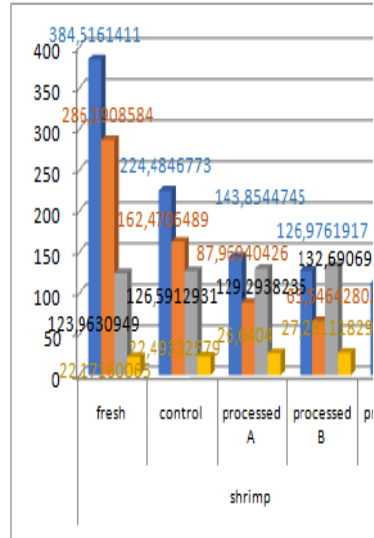
## Results and Discussion

### Research result

The illustration of the research results can be shown in Figure 1. below.



**Figure 1a. Reduction of Heavy Metals Cd, Pb and Their Effects on Ca and Protein Levels of Various Crab Processed**



**Figure 1b. Reduction of Heavy Metals Cd, Pb and Their Effects on Ca and Protein Levels in Various Processed Shrimp**

Figure 1. shows that crabs absorb much more Cd (576.4ppb), Pb (497.5ppb) than shrimp in absorbing Cd (384.5ppb), Pb (286.1ppb). In the preparation of processing, as is the culture of the community to remove the rancid/fishy smell by giving lime. So it decreased to 411.7ppb Cd, 256.8ppb Pb for crabs, while in shrimp it decreased to 224.4ppb Cd, 162.4ppb Pb. After being processed using Indonesian natural spices for crab preparations and decreased Cd, Pb decreased successively higher, namely processed A, B, and C. On the other hand, Ca and protein levels actually increased.

In the study, before being processed, in the preparation stage of processing, crabs and shrimps were soaked in lime juice. It is known that according to the description of Figure 1., in the Control section after being given lime, each sample experienced a decrease of 28.57%

Cd, and 48.38% of Pb in Crab. Shrimp after soaking in lime juice decreased 41.63% of Cd, 43.39% of Pb in shrimp.

After processing with preparations A, B, C, Cd in crabs decreased by 41.34% in processed A, decreased by 43.84% in processed B, decreased Cd to 45.44% in processed C. While in shrimp, after processing with preparations A, B, C, then Cd in shrimp decreased 62.65% in processed A, decreased 67% in processed B, decreased Cd 70.79% in processed C.

After processing with preparations A, B, C, the Pb in crab decreased by 52.69% in preparation A, decreased by 60.28% in preparation B, decreased by 70.23% in Pb in preparation C. While in shrimp, after processing with preparations A, B, C, then Pb in shrimp decreased by 54.81% in processed A, decreased by 77.09% in processed B, decreased Pb by 86.23% in processed C.

In terms of nutritional levels, both crab and shrimp, after being processed with spices, it tends to increase. From fresh crab, after being given lime, then processed A, B, C, the Ca increased by: 192.27; 192.89; 195.50; 199.05; 203.07mg/100g. Whereas in protein after being processed with processed spices A, B, C, the protein content becomes: 14.737; 15.27; 17.35; 17.99; 19.09g/100g.

For fresh shrimp, after being given lime, then processed A, B, C, The Ca increased by: 123.96; 126.59; 129.29; 132.69; 136.85mg/100g. Whereas in protein after being processed with processed spices A, B, C, the protein content increased: 22.17; 22.49; 26.64; 27.28; 28.36g/100g.

### Research Data Analysis

The data on the results of the study were then analyzed by analysis of variance, followed by a further test of LSD, and regression using SPSS 16. The recapitulation of the results of the analysis can be seen in Table 1. below.

**Table 1. Recapitulation of the Significance of the Effects of X1 (Types of Crab, Shrimp) and X2 (Processed Kinds A, B, C) and their Interactions (X1 and X2) as well as the Contribution of X1, X2, and Their Interactions in Influencing Cd, Pb, Ca, and Protein**

I	Significance of Influence (Anava)		% Contribution (Regression)		
	Partial	X1*X	X1	X2	X1*X2
n		2 . B S N			
fl		Inter et i o			
u		actio w g t			
e		n e n			
n					



c e o n Y	X1 (produ ct type: mud crab and shrimp )	X2 (proce ssed type)	F	s	n	e	e	F	s	%	F	s	%	F	s	%
C	1	.6	. .	. .	K	. *	2	. 2	5	. 5	5	. 7				
d	.0	.0	2 9	0 3	-	0	n ,	0 1	5 4	0 0	8 7	, 0	0 0			
l	6 0	3 0	0 0	5 5	K	0	s	1 0	5	0	2	5	0			
e	0 *	7 *			n	o	.	* 8 *	7 *	9 *		8 *				
v	E *	E *			s	+	0 *	7 *								
e					A	7	n									
l	3	3			=	2	s									
					B		*									
					A	.	*									
					≠	0	*									
					C	0	*									
						2	*									
					B		*									
					=		*									
					C	.	*									
						1	*									
					K	1	*									
					o	6	*									
					-											
					A											
					K	.										
					o	0										
					-	0										
					B	0										
					K											
					o											
					-	.										
					C	0										
						0										
					K	0										
					+											
					A											

K .  
+ 0  
B 0  
K 0  
+  
C  
  
. 0  
0  
0  
  
. 0  
0  
0  
  
. 0  
0  
0  
  
K . \* 4 . 3 2 . 4 5 . 7  
o 0 \* 2 0 5. 7 0 1. 9 0 0.  
- 0 \* , 0 1 , 0 8 , 0 0  
K 0 \* 2 0 \* 6 0 \* 7 \*  
o . \* 7 \* 8 \* 7 \*  
+ 0 \* 7 \* 5 \*  
A 0 \*  
≠ 0 \*  
B . \*  
o 0 \*  
A 0 \*  
≠ 0 \*  
C . \*  
o 0 \*  
B 0 \*  
≠ 0 \*  
C . \*  
o 0 \*  
K 0 \*  
o 0 \*  
- .  
A 0  
K 0  
o 0

P  
b  
. ,  
l  
e  
v  
e  
l  
2  
5  
.  
0  
0  
3  
2  
4  
\*  
5  
.  
0  
0  
4  
\*  
3  
1  
.  
0  
0  
4  
\*  
8  
3  
0  
.  
0  
0  
0  
\*  
K  
o  
-  
K  
o  
+  
A  
≠  
B  
A  
≠  
C  
o  
B  
≠  
C  
o  
K  
o  
-  
A  
K  
o

- .  
 B 0  
 K 0  
 o 0  
 - .  
 C 0  
 0  
 K 0  
 + .  
 A 0  
 K 0  
 + 0  
 B .  
 K 0  
 + 0  
 C 0  
 K . n 1 . 1 2 . 9 2 . 9  
 o 0 s 3 0 4. . 0 8. . 0 9.  
 - 8 \* , 0 9 8 0 7 6 0 1  
 = 9 \* 6 0 7 \* 2 \* 4 0  
 K . \* 7 \* 2 \* 8 \*  
 o 0 \* 4 \* E \* E \*  
 + 0 \* 3 3  
 A 2 \*  
 ≠ . \*  
 B 0 \*  
 0 \*  
 A 0 \*  
 ≠ . \*  
 C 0 \*  
 0 \*  
 B 0 \*  
 ≠ . \*  
 C 0 \*  
 0 \*  
 K 0  
 o .  
 - 0  
 A 0  
 K 0  
 o .  
 - 0  
 B 0  
 K 0  
 o .  
 - 0

C 1 . 3 . . .  
 a 4 0 . 0 2 9  
 l 6 0 5 0 6 0  
 e , 0 7 0 2 1  
 v 6 \* 5 \* s  
 e 9 \* E \*  
 ls 3 4

							C	2	
							K	4	
							+	0	
							A	0	
							K	0	
							+	.	
							B	0	
							K	0	
							+		
							C		
P	2	.	4	.	1	.	K	.	*
r	8	0	9	0	0	0	o	0	3
o	,	0	6	0	,	0	-	1	4
t	2	3	.	0	4	0	K	8	,
e	4	*	1	*	3	*	o	.	3
i	5		6	*	5	*	+	0	8
n			8				A	0	*
L							≠	3	*
e							B	.	*
v							0	0	*
e							A	0	*
l							≠	0	*
							C	.	*
							0	0	*
							B	0	*
							≠	0	*
							C	.	*
							0	0	*
							K	0	*
							o	0	
							-	.	
							A	0	
							K	0	
							o	0	
							-	.	
							B	0	
							K	0	
							o	0	
							-	.	
							C	0	
							0	0	
							K	0	
							+	.	
							A	0	

---

K	0
+	0
B	.
K	0
+	0
C	0

Information:

X1: Variation of product types: k ( mangrove crab ), u (shrimp)

X2: Variation of processed types: Ko- (before processing, without lime), K+ (before processing, lime was given 15 minutes), A (dabu-dabu), B (rica-rica), C (woku)

Y1: Heavy Metal Content Cd

Y2: Heavy Metal Content Pb

Y3: Ca levels

Y4: Protein Content

ns : non significant

\*: significant \*\*: very significant

Based on data analysis, it was shown that the types of pond/sea products (X1), namely crabs and shrimps, had very different effects on the uptake of heavy metals Cd, Pb, as well as levels of Ca and protein. Likewise, the types of preparations made by spices A, B, C (X2) showed different effects on the levels of Cd, Pb, Ca, and protein. Although between treatments X1, X2 does not necessarily indicate an interaction, for example toward Cd and Ca.

Fresh crabs and shrimp before being processed, significantly different levels of Cd, Pb and after processing. Processing the different treatment has the effect to lowering Cd, Pb, and vice versa, increasing the nutritional content of Ca and protein.

Further analysis of LSD also showed that the types of pond/sea products and processed with spices were significantly different between treatments, which showed very different uptakes of Cd, Pb, Ca and protein. Except that the Cd levels between the A preparations were the same as those of the B preparations; processed B is the same as C; as well as pond/sea products on Ca levels, between fresh and those that have been given lime. But after going through processing A, B, or C all showed significant differences, and it was appropriate to decrease Cd, Pb, and increase Ca, protein.

Contribution in influencing Cd, Pb, Ca, protein can be shown from the regression test. It is known that X1 contributes to the decrease in Cd by 25.1%; to the decrease in Pb by 27.69%; to the

increase in Ca by 14.9%; to the increase in protein by 30.6%. While the contribution of X2 in influencing Cd was 58.7%, Pb was 41.8%, Ca was 98.7%, and to protein was 87.3%. Between variables shows all interactions with a contribution to Cd of 76.0%; Pb by 70%; Ca of 99.1; and 96% protein. The results of this analysis are very interesting to note, because the contribution of X1 is less than 50% (14.9%-30.6%), much different from the contribution of X2 which is generally more than 50% (high contribution), which is around 41.8 %-98.7%. Likewise, if one considers the contribution of X1 and X2 interactions at the same time, it becomes very high, which is around 70%-99.1%.

## **Discussion**

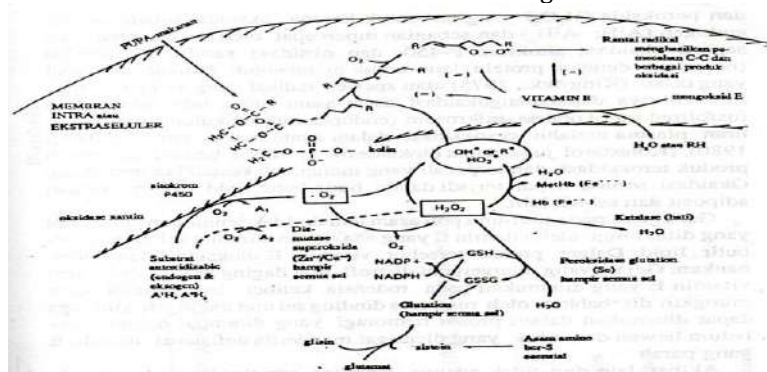
### **The Effect of Variations in Types of Foodstuffs (Crab with Shrimp) on Heavy Metal Uptake Cd, Pb, and Levels of Ca, Protein**

The analysis of variance test showed that crabs were significantly different from shrimps in absorbing Cd ( $F = 1.660E3$   $p = 0.000^{**}$ ). Likewise for Pb uptake ( $F = 25.225$   $p = 0.004^{**}$ ). As is known, the sea and the pond environment are downstream which become reservoirs of pollutants from the upstream and surrounding areas. Crabs and shrimps are among the less active, sedentary macroinvertebrates than fish. With its *filter feeder* character, absorb/eat everything in its environment, including the surrounding pollutants, so that it is more likely to accumulate heavy metals at high levels [9]. From previous studies, it is known that crabs and shrimp can accumulate heavy metals in their bodies, which can be harmful to consumers. However, because mangrove crabs and shrimp have different characteristics of life, it is appropriate in the study to show that the uptake of heavy metals is higher in mangrove crabs than shrimp. Crabs are less active, so they generally settle in certain locations, and inhabit on a muddy bottom, so that it is more likely that heavy metal accumulation is high, in addition, heavy metals have a higher specific gravity, so that in the environment they are more commonly found at the bottom.

Paying attention to the area used as the research location, Pasir Sakti Lampung Timur, is one of the metropolitan areas, a fishery-based business area with marine products and ponds mainly vaname shrimp (*Litopenaeus vannamei*), and a priority for the livelihoods of the surrounding residents. The most abundant non-cultivated product is mud crab (*Scylla serrata*). Kariada and Irsadi [18], stated that naturally, the sea is the last place for waste, which should later be

absorbed by mangroves. But if you pay attention, this pond area is downstream which has the potential to become a waste container, including heavy metals Cd, Pb from various industrial activities, agriculture, transportation, households, from upstream and surrounding areas. Therefore, marine and aquaculture products can be contaminated with Cd, Pb, which accumulate in the body tissues, which will give an opportunity to affect the nutritional content of the fishpond products, and potentially interfere with the health of consumers.

The higher metal accumulation gives an indication of the increase in free radicals, so that it will have an effect on the opportunity to decrease the nutritional content of Ca and protein. An illustration of this mechanism can be seen in Figure 2. below.



**Figure 2. Mechanism of Free Radical Pollutants in Cell Damage and Protein Degradation [19]**

The entry of heavy metals will block the work of enzymes and reduce Ca and protein nutrients. As Saygideger [20] in his research on chlorophyll states, that the mechanism of inhibition of the chlorophyll biosynthesis process due to Pb metal is by blocking the work of enzymes needed in the chlorophyll biosynthesis process. One of the important enzymes that play a role in chlorophyll biosynthesis is aminolevulinic acid (ALAD) which catalyzes the formation of porphobilinogen. It is explained that the heavy metal Pb can inhibit ALAD activity by binding to the SH enzyme group and inhibiting the overall chlorophyll biosynthesis through Mg<sup>2+</sup>. In line with this, heavy metals can remove Ca ions from their compounds, in this case the bodies of crabs and shrimps, thereby replacing the Ca leaching position which is then replaced by pollutant metal ions/free radicals

that pollute them. Meanwhile, the decrease in protein is due to the role of heavy metals as free radicals, which have a damaging effect on cell membranes and ultimately damage DNA which in the end the protein synthesis process will be disrupted, so that a decrease in protein levels was detected, with different levels in crabs and shrimp, due to the high absorption levels. it is different. In the study, the uptake of 576.4ppb Cd, 497.5ppb Pb crab was almost double that of 384.5ppb Cd, 286.1ppb Pb shrimp, in line with these data levels of Ca (192.27 mg/100g) and protein (14,737 g/100g) contained in the mud crab body is about half that found in shrimp (123.96 mg/100g Ca; 22.17 g/100g protein).

Paying attention to the results of the regression analysis, it shows that the contribution of the X1 variable in influencing the metal content is 25.1% for Cd, and 35.1% for Pb. These data indicate that although the levels of Pb metal were found to be lower than Cd, it had a greater effect on the bodies of crabs and shrimps. So that Pb contamination at the research site under certain conditions should be handled more priority. It could be because the source is more abundant, the type of Pb is active in the form of dissolved or precipitated ions that affect biota in absorbing, or other factors that have not been studied.

### **Effect of Variations in Processed Spices (A, B, C) on Heavy Metal Uptake of Cd, Pb, and Ca, Protein Content**

From the analysis of variance test, it was shown that the variation of processed with different spices had a very significant effect on the absorption of Cd, Pb, Ca, crab and shrimp protein. Of *treatment* carried out, due to differences in processing can affect the levels of Cd ( $F = 6,367E3 \geq p = 0.000 **$ ). Likewise for Pb levels ( $F= 35,301 p = 0.004**$ ), and for Ca levels ( $F= 3,575E4 p= 0.000**$ ), also for protein levels ( $F= 496,168 p= 0.000**$ ). Processes A, B, C use different spices, successively the more kinds and the number of spices used, the decrease in Cd, Pb, and preferably an increase in Ca, protein. The contribution of the variety of processed spices to the decrease in Cd was 58.7%; Pb 41.8%; increase in Ca 98.7%; 87.3% protein.

The technique of processing mud crab and shrimp in gravy, stir-fried spices, and fresh spices requires several important steps, such as adding core spices and adding natural fruit juices, including lime in crab and shrimp meat. The herbs or spices contain antioxidants that are useful for the human body. Consuming foods that



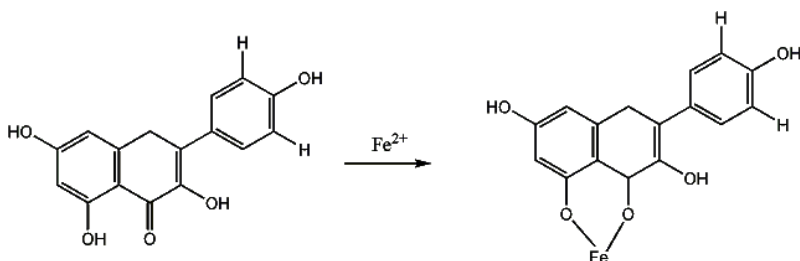
contain antioxidants can ward off free radicals, including heavy metal pollutants Cd, Pb. In this study, spices were used in the processing of types A, B, C. Sources of natural antioxidants can come from various types of plants such as fruits, vegetables, spices, tea, or enzymes and proteins [21].

There are many types of processed Indonesian spices, which are often used, namely ginger, turmeric, chili, shallots, garlic, basil leaves. Turmeric is a type of spice that has the highest antioxidant activity. Turmeric has the most important compounds, namely curcuminoid components such as curcumin, demethoxycurcumin, and bis-demethoxycurcumin. This curcuminoid compound has potential as a natural antioxidant which has been studied as an anti-inflammatory, antioxidant, antibacterial, and cardioprotective. Ginger has antioxidant activity because it contains oleoresin phenolic compounds such as gingerol and shogaol. Ginger has the main substance gingerol which can lower blood glucose levels and increase the production of the hormone insulin. Ginger contains zingiberene and zingiberol compounds that make ginger taste spicy when consumed [21].

Basil leaves (*Ocimum tenuiflorum* L.) are herbaceous plants that are used as medicine due to the presence of active compounds such as eugenol, urosolic acid, *carvacrol*, linalool, *methyl carvicol*, sitosterol including saponins, flavonoids, triterpenoids and tannins. All of them have varied biological activities, besides that many phenolics have been identified which exhibit antioxidant [22]. In onions can be found flavonoid compounds. Flavonoids are substances that contain polyphenolic compounds derived from plants. Flavonoids are antioxidants that have the potential to ward off free radicals, so they are often used as a prevention or treatment of cancer [23].

Garlic contains organosulfur and phenolic compounds as antioxidants which play a very important role in preventing cell and organ damage from the oxidation process. Phenolic compounds from garlic have one or more groups, namely as hydrogen proton donors and neutralizing free radicals [24]. Chili contains several vitamins. One of the vitamins in chili is vitamin C (ascorbic acid). Vitamin C acts as a strong antioxidant that can protect cells from cancer-causing agents, and is specifically able to increase the body's absorption of calcium (a mineral for the growth of teeth and bones) and iron from other foodstuffs [25].

Flavonoid compounds, phenolics and tannins are compounds that are responsible for antioxidant activity. The antioxidant activity of flavonoid, phenolic and tannin compounds is due to the fact that the three compounds are phenolic compounds, namely compounds with -OH groups attached to the carbon of the aromatic ring. These phenolic compounds have the ability to donate hydrogen atoms so that radicals can be reduced to a more stable form [24]. Flavonoid compounds are flavonols (kemferol) which are compounds that have phenol in their molecules, while phenols are compounds with a benzene nucleus having an -OH group. The antioxidant mechanism of this compound is through the severance of the peroxy radical chain and scavenger. Kemferol which belongs to the flavonoid group is an organic compound of natural ingredients and is a polyphenol compound (phenolic compound that has more than one hydroxyl group) [26]. The mechanism of metal binding by flavonoid compounds, namely kemferol compounds of the flavonol group is as follows.



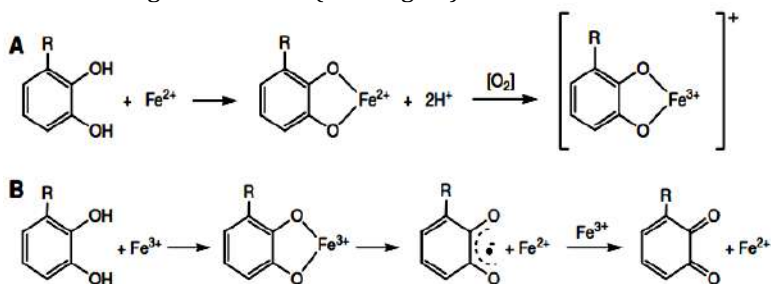
**Figure 3. Mechanism of Metal Binding by Flavonoids / Antioxidants Source: Fauziah, et al. (2017)**

Against other metals, including heavy metal Cd, Pb can be analogous to the reaction in Figure 3.

Antioxidants can capture radical compounds that are formed before these compounds damage proteins further. Due to the presence of phenolic compounds, free radicals formed will react with these phenolic compounds to form stable products and unreactive phenolic radicals because they are stabilized by resonance. OH• radicals are very strong oxidants and can react with almost all biological substrates so that they can cause various cell damage. The hydroxyl radical (OH •) in the body is produced by the reaction of the Fenton reaction between iron (II) with H<sub>2</sub>O<sub>2</sub>. The reaction is: Fe<sup>2+</sup> + H<sub>2</sub>O<sub>2</sub> → Fe<sup>3+</sup> + OH• + OH<sup>-</sup>. The formation of this OH radical can be

limited by reducing the oxidation reaction catalyst, namely the metal ion  $\text{Fe}^{2+}$ . Antioxidant *chelators* are antioxidants that work by binding to metals that act as oxidation reaction catalysts to reduce the number of metal ions  $\text{Fe}^{2+}$  so as to limit the formation of hydroxyl radicals from metal reactions with hydrogen peroxide [26].

Spices contain flavonoid compounds that function as antioxidants, including the class of phenolic compounds that are polar and can dissolve in water. Flavonoids is one of the phenolic compound that have properties as antioxidant and free radical scavengers [27]. Based on their structure, flavonoids have more than one phenol group (-OH and aromatic groups) and have conjugated double bonds, so they are able to ward off free radicals [28]. Flavonoids are able to donate one hydrogen atom from the phenolic hydroxyl (OH) group when reacting with free radicals. The flavonoids in longan honey play a role in capturing and counteracting free radicals (scavengers).



**Figure 4. Reaction of metal binding by flavonoid compounds** Chelators play an important role in binding heavy metals in an organism. Besides being a free radical, Fe is also a source of reactive oxygen radicals or *reactive oxygen species (ROS)*. Flavonoid compounds are able to bind heavy metals and produce complex compounds such as Fe (II) and Fe (III) which are more stable.

By applying the right processing techniques in processing crabs and shrimps, it is known that processed techniques have a great opportunity to reduce pollutant levels of Cd, Pb, even because spices also contain certain nutritional compositions, they not only reduce Cd, Pb, but even increase Ca, protein in processed foods. *seafood*.

Several studies have proven that antioxidants in lemongrass are indicated by the presence of high phenolic compounds [29]. Better results will be shown by lemongrass when

combined with other spices such as basil leaves [30]. Red galangal rhizome (*Alpinia galanga*) is one of the plants that is efficacious in medicine and contains phenolic and flavonoid compounds. The results of phytochemical screening showed that the ethanol extract of galangal rhizome contained flavonoids, triterpenoids/steroids, phenolic compounds, and saponins. The rhizome of galangal contains about 1% greenish-yellow volatile oil which mainly consists of 48% methyl cinnamate, 20% cineol, 30% eugenol, 1% camphor, sesquiterpenes, -pinene, galangin, resin called galangol, yellow crystals which called kaempferida, kadinen, hexabidrocadalene hydrate, quercetin, kaemferol, starch, and several other flavonoid compounds. The antioxidant activity of galangal comes from quercetin, kaemferol, and galangin [31].

The information provided by [30], that the combination of spices gives better results strengthens the assumption that processed spices which are generally always combined will also have a greater chance of reducing free radicals including pollutants Cd, Pb. As a culture of Indonesian society, always combine various spices to create the taste and delicacy of cuisine. Among them are using garlic seasoning which makes the preparations savory and rich in antioxidants [32]. Furthermore, it is combined with shallots, which add deliciousness and are rich in active substances for treatment and antioxidants, as well as additional green onions and onion bulbs which add to the delicacy of cooking. The presence of important nutrients in spices will also provide opportunities for increasing nutrients in processed food, including in the study shown a slight increase in Ca and protein levels, after being processed with antioxidant spices, where processed C with the most spices in type and amount, was able to reduce metal Cd, Pb; and increase the nutritional levels of Ca and protein.

### **Interaction Effect of Variations in Types of Foodstuffs (Crab with Shrimp) and Types of Processed Seasonings (A, B, C) on Heavy Metal Uptake of Cd, Pb, and Ca, Protein Content**

From the recapitulation of data analysis, the interaction between X1 and X2 showed that the levels of Cd ( $F= 0.205$  0.935) and Ca ( $F= 0.262$  0.901), were not significantly different. Meanwhile, the Pb ( $F= 40,830$  0.000) and protein ( $F= 11.435$  0.000) were very significant. Although X1 and X2 have a major contribution in influencing the levels of Cd (76.0%), Pb (70.0%), Ca (99.1%), and protein (96.0%). The results of this analysis indicate that between X1

and X2 do not always synergize in carrying out antioxidant mechanisms and neutralizing free radicals uptake of Cd, Pb, and increasing Ca and protein. Crab and shrimp food ingredients as well as variations of processed spices A, B, C do not necessarily affect Cd, Ca together. But together they affect Pb and protein levels.

## **Conclusion**

Based on the data and analysis carried out, it can be concluded that: 1) Variations in processed materials, namely crab and shrimp, affect the presence of heavy metals Cd, Pb, Ca, and protein; 2) Variations of spices in crab and shrimp preparations have an effect on decreasing Cd, Pb, and increasing Ca, protein. Processed type C has the best effect in reducing Cd, Pb and increasing Ca, processed protein. On Cd, treatment A has the same effect as B, B is the same as C, but A is not the same as C; while for Pb, Ca, the protein between the processed variations was very significantly different, the most appropriate was processed C with the most and varied spices, then B, and finally A, each of which was different from the negative control, ie the fresh ones were not given anything; positive control who was given only lime; 3) Each *treatment* has a different contribution in influencing the uptake of Cd, Pb, Ca, protein; where compared to crab and shrimp food types, processed types with lots of spices contributed more in reducing heavy metals Cd, Pb, and increasing Ca, protein.

## **Suggestions and Recommendations**

In order to obtain the main benefits related to its implementation in the community, it is necessary to: 1) Further research by cultivating and exploring local wisdom and potential in managing the downstream environment which is assumed to be a reservoir for waste from upstream and surrounding areas, as an alternative to food management and alternative management of ponds from a polluted environment; 2) Conducting innovation through various competitions and competitions based on sustainable environmental management.

## **Reference**

- [1] H. Widowati, A. Sutanto, W. S. Sulistyani, and A. F. Dewi, "Bookchapter. The Pandemic a Leap of Faith. Heavy Metal Polutant Foodstuff Management on the Downstream Area bu Utilizing Local Wisdom and Culture as Teaching Material of Bioremediation and Chemical Environment Course," in

- Bookchapter. The Pandemic a Leap of Faith. Heavy Metal Pollutant Foodstuff Management on the Downstream Area bu Utilizing Local Wisdom and Culture as Teaching Material of Bioremediation and Chemical Environment Course*, 1st ed., D. Karmiyati, Ed. Malang: UMM Press, 2021, pp. 239–247.
- [2] B. Anggraini, H. Widowati, and W. S. Sulistyani, “PENGARUH PERENDAMAN JENIS BUAH TERHADAP PENURUNAN KADAR KADMIUM (Cd) PADA UDANG VANNAME (Litopenaeus vannamei) TAMBAK INTENSIF DEKAT DAN JAUH MANGROVE,” *Biolova*, vol. 2, no. 2, pp. 151–163, 2021, doi: 10.24127/biolova.v2i2.1110.
- [3] D. Susilawati, H. Widowati, W. S. Sulistiani, and U. M. Metro, “PENGARUH VARIASI PERENDAMAN UDANG VANAME (Litopenaeus vannamei) DALAM ASAM BUAH ALAMI TERHADAP PENURUNAN KADAR TIMBAL (Pb) DI TAMBAK TRADISIONAL PASIR SAKTI LAMPUNG TIMUR.” [Online]. Available: <http://scholar.ummetro.ac.id/index.php/biolova/>.
- [4] (BPOM), *Badan Pengawas Obat dan Makanan Indonesia*, no. 88. Indonesia, 2018, pp. 1–155.
- [5] O. D. Adeyolanu, O. J. Kadiri, K. S. Are, and G. A. Oluwatosin, “Lead and cadmium contents in a medicinal plant/spice grown in an urban city of Nigeria,” *Cogent Food Agric.*, vol. 2, no. 1, 2016, doi: 10.1080/23311932.2015.1136016.
- [6] J. Djedjibegovic *et al.*, “Heavy metals in commercial fish and seafood products and risk assessment in adult population in Bosnia and Herzegovina,” *Sci. Rep.*, vol. 10, no. 1, pp. 1–8, 2020, doi: 10.1038/s41598-020-70205-9.
- [7] R. Rosnani and R. Rasman, “ANALISA KANDUNGAN KADMIUM (CD) PADA BAWANG MERAH (ALLIUM CEPA) DI KELURAHAN MATARAN KECAMATAN ANGGERAJA KABUPATEN ENREKANG,” vol. 19, no. 2, pp. 239–245, 2019.
- [8] H. P. Kusumaningrum, Herusugondo., M. Zainuri, and B. Raharjo, “Analisis Kandungan Kadmium (Cd) dalam Tanaman Bawang Merah dari Tegal,” *J. Sains dan Mat.*, vol. 20, no. 4, pp. 98–102, 2012, [Online]. Available: <https://ejournal.undip.ac.id/index.php/sm/article/view/8021/6574>.
- [9] W. Sa’adah and K. Milah, “PERMINTAAN UDANG VANNAMEI (Litopenaeus vannamei ) DI KELOMPOK PEMBUDIDAYA UDANG AT-TAQWA PACIRAN LAMONGAN VANNAMEI SHRIMP (Litopenaeus vannamei) DEMAND IN AT-TAQWA SHRIMP

- CULTIVATION GROUP PACIRAN LAMONGAN," 2019.
- [10] S. M. Indirawati, "Pencemaran Pb dan Cd dan Keluhan Kesehatan pada Masyarakat di Kawasan Pesisir Belawan," *J. Jumantik*, vol. 2, no. 2, pp. 54–60, 2017.
- [11] H. Widowati, A. Sutanto, and W. S. Sulistiani, "Keefektifan Pencucian dan Pengolahan untuk Mempertahankan Gizi Pangan Hewani Kawasan Pertanian Tercemar Logam Berat Pb," in *Prosiding Seminar Publikasi Hasil Penelitian dan Pengabdian*, 2018, vol. 917.
- [12] H. Widowati, A. Sutanto, M. Cholvistaria, W. S. Sulistiani, and F. A. Dewi, "Comparing the effects of washing and processing on nutrient levels of plant and Animal Foods Contaminated by Heavy Metals Cd, Pb," *Int. J. Innov. Creat. Chang.*, vol. 13, no. 2, pp. 435–450, 2020.
- [13] N. I. Said, "METODA PENGHILANGAN LOGAM BERAT (As, Cd, Cr, Ag, Cu, Pb, Ni dan Zn) DI DALAM AIR LIMBAH INDUSTRI," *J. Air Indones.*, vol. 6, no. 2, pp. 136–148, 2018, doi: 10.29122/jai.v6i2.2464.
- [14] Melda, "ILMU PANGAN DASAR : BUMBU DAN REMPAH," 2014. <http://meldafakhriana.blogspot.com/2014/01/ilmu-pangan-dasar-bumbu-dan-rempah.html>.
- [15] I. Ama *et al.*, "Perancangan Video Dokumenter Tentang Wisata Kuliner Ikan Bakar Di Kota Makassar."
- [16] A. Siwi and P. Tyas, "Identifikasi Kuliner Lokal Indonesia dalam Pembelajaran Bahasa Inggris," 2017.
- [17] F. Indriaty, "Peningkatan Cita Rasa Bumbu Woku Pada Ikan Tuna," *J. Penelit. Teknol. Ind.*, vol. 8, no. 2, p. 151, 2018, doi: 10.33749/jpti.v8i2.2222.
- [18] N. Kariada and A. Irsadi, "PERANAN MANGROVE SEBAGAI BIOFILTER PENCEMARAN AIR WILAYAH TAMBAK BANDENG TAPAK, SEMARANG (Role of Mangrove as Water Pollution Biofilter in Milkfish Pond, Tapak, Semarang)," *J. People Environ.*, vol. 21, no. 2, pp. 188–194, 2014, doi: 10.22146/jml.18543.
- [19] M. C. Linder, *Biokimia; Nutrisi dan Metabolisme*. Fullerton: Department of Chemistry, California State University, 1992.
- [20] S. Saygideger, M. Dogan, and G. Keser, "Effect of Lead and pH on Lead Uptake, Chlorophyll and Nitrogen Content of Typha latifolia L. and Ceratophyllum demersum L." [Online]. Available: <http://www.ijab.org>.
- [21] A. W. Helmalia, P. Putrid, and A. Dirpan, "Potensi Rempah-Rempah Tradisional Sebagai Sumber Antioksidan Alami Untuk

- Bahan Baku Pangan Fungsional),” *Canrea J. Food Technol. Nutr. Culin. J.*, vol. 2, no. 1, pp. 26–31, 2019, doi: 10.20956/canrea.v2i1.113.
- [22] B. Chandra *et al.*, “PHYTOCHEMICAL SCREENING AND ANTIOXIDANT ACTIVITIES OF KEMANGI LEAF (*Ocimum tenuiflorum* L.) METHANOL EXTRACT USING DPPH (1,1-diphenyl-2-picrylhydrazine) METHOD SKRINING FITOKIMIA DAN AKTIVITAS ANTIOKSIDAN EKSTRAK METANOL DAUN KEMANGI (*Ocimum tenuiflorum* L.,” *J. Pharm. Sci. /Volume*, vol. 2.
- [23] S. Rohmawati *et al.*, “PERBEDAAN JUMLAH BILANGAN PEROKSIDA MINYAK GORENG DENGAN PENAMBAHAN BAWANG MERAH DAN BAWANG PUTIH SEBAGAI ANTIOKSIDAN ALAMI (Pada Pedagang Gorengan di Wilayah Kecamatan Tembalang Kota Semarang Tahun 2016),” 2017. [Online]. Available: <http://ejournal-s1.undip.ac.id/index.php/jkm>.
- [24] D. Prasonto, E. Riyanti, and M. Gartika, “UJI AKTIVITAS ANTIOKSIDAN EKSTRAK BAWANG PUTIH (*Allium sativum*),” 2017.
- [25] R. Rachmawati, R. Defiani, and L. Suriani, “PENGARUH SUHU DAN LAMA PENYIMPANAN TERHADAP KANDUNGAN VITAMIN C PADA CABAI RAWIT PUTIH (*Capsicum frutescens*) EFFECT OF TEMPERATURE AND LENGTH OF STORAGE ON VITAMIN C CONCENTRATION OF CHILLI (*Capsicum frutescens*).”
- [26] S. Fauziah and S. Syahmani, “POTENSI ANTIOKSIDAN KULIT BATANG TUMBUHAN KETAPANG (*Terminalia catappa* Linn.),” *Quantum J. Inov. Pendidik. Sains*, vol. 2, no. 1.
- [27] Z. A. Zakaria, “Free radical scavenging activity of some Mangroves available in Bangladesh,” *Orient. Pharm. Exp. Med.*, vol. 6, no. 1, pp. 58–64, 2006, doi: 10.3742/opem.2006.6.1.058.
- [28] B. Arifin and S. Ibrahim, “Struktur, Bioaktivitas Dan Antioksidan Flavonoid,” *J. Zarah*, vol. 6, no. 1, pp. 21–29, 2018, doi: 10.31629/zarah.v6i1.313.
- [29] J. Cheel, C. Theoduloz, J. Rodríguez, and G. Schmeda-Hirschmann, “Free Radical Scavengers and Antioxidants from Lemongrass (*Cymbopogon citratus* (DC.) Stapf.),” *J. Agric. Food Chem.*, vol. 53, pp. 2511–2517, May 2005, doi: 10.1021/jf0479766.
- [30] M. S. Sangi, “Aktivitas Antioksidan Pada Beberapa Rempah-Rempah Masakan Khas Minahasa,” *Chem. Prog.*, vol. 4, no. 2, 2012, doi: 10.35799/cp.4.2.2011.4976.
- [31] A. N. Sari, “Berbagai Tanaman Rempah Sebagai Sumber Antioksidan Alami,” *Elkawanie*, vol. 2, no. 2, p. 203, 2016, doi:



10.22373/ekw.v2i2.2695.

- [32] U. Hernawan and A. Setyawan, "Senyawa Organosulfur Bawang Putih (*Allium sativum* L.) dan Aktivitas Biologinya," *Biofarmasi*, vol. 1, p. 65, Aug. 2003.

# Teaching the Capita Selecta of Zoology Era 5.0 Based on the Surrounding Approach

Hening Widowati<sup>46</sup>, Agus Sutanto<sup>47</sup>, Widya Sartika Sulistiani<sup>48</sup>,  
Evita Anggereini<sup>49</sup>, Maria Ulfah<sup>50</sup>, Merri Sri Hartati<sup>51</sup>, Asih  
Fitriana Dewi<sup>52</sup>

## Introduction

It is a necessity, a change in human civilization. Such is the case today. Globalization has penetrated all aspects of life. Obvious objective facts can be seen now, there is a revolution of expansion mainly in the world of industry and information, which has an impact on other fields, including education. Coupled with the COVID-19 pandemic, forcing the world of education to revitalize the learning process. Learning which was initially carried out face-to-face, was forced to carry out learning activities in internet-assisted networks (online). What started out as an emergency, in the end, after almost two years, has become a culture that provides enough experience and educators have indirectly succeeded in carrying out and practicing innovations in learning with a number of advantages and disadvantages.

Such is the case in the world, the Industrial Revolution 4.0 with the sophistication of information technology, is able to accelerate industrial development. According to Anggraheni and Astuti [1], the acceleration of industrial development in fact has implications for demoralization, a shift in values and traditions, resulting in social and economic inequality. According to him, the industrial world continues to emphasize production efficiency without looking further at the side where many human jobs will be replaced. Humans have to compete with robots and production machines. On the other hand, according to BPS 2021 data [2], Indonesia is still in the demographic bonus period. The percentage of the productive age population (15–64

---

<sup>46</sup> UM Metro, [hwummetro@gmail.com](mailto:hwummetro@gmail.com)

<sup>47</sup> UM Metro, [sutanto11@gmail.com](mailto:sutanto11@gmail.com)

<sup>48</sup> UM Metro, [widya.sulistyani@gmail.com](mailto:widya.sulistyani@gmail.com)

<sup>49</sup> Jambi University, [Evita\\_pklh@yahoo.com](mailto:Evita_pklh@yahoo.com)

<sup>50</sup> Univ. PGRI Semarang, [mariaulfah@upgris.ac.id](mailto:mariaulfah@upgris.ac.id)

<sup>51</sup> UM Bengkulu, [merrisrihartati@umb.ac.id](mailto:merrisrihartati@umb.ac.id)

<sup>52</sup> IAIN Metro, [fitriana3003@gmail.com](mailto:fitriana3003@gmail.com)

years) has continued to increase since 1971. In 1971 the proportion of the productive age population was 53.39 percent of the total population and increased to 70.72% from 270.20 million people in 2020. The difference between the percentages The productive and non-productive age population (0–14 years and 65 years and over) looks sharper in 2020. The percentage of the productive age population is larger than the non-productive age population. So more and more human labor is no longer used because its role is replaced by technology.

In the world of education, this creates an important gap to find a solution, efforts to build students' personal skills and are able to innovate, creating employment opportunities for the productive age population that dominates Indonesia. Society 1.0 humans are still in the era of hunting and recognizing writing. In society 2.0, the era of knowing agriculture, humans have started to know farming. In society 3.0, it has entered the industrial era, when humans have started using machines to support their daily activities. After that came society 4.0, namely humans who are familiar with accessing and sharing information on the internet. Society 5.0 is an era where all technology is part of humans themselves. Internet is not only for information but for living life. So that technological developments can minimize the gap in humans and economic problems in the future. The education sector has an important role in this regard. The revolution of society 5.0 is more focused on humans who have a more critical paradigm of thinking. Fukuyama [3] stated that Society 5.0 was introduced by Japan as a continuation of Society 4.0, where rapid technological advances were seen as having the potential to degrade human roles.

The concept of Society 5.0 is expected to shape people's lives that are *technology-based* and *human-centered*. Humans should play an active role in controlling the direction of technological development, creating a balance between technology as a trigger for economic development and as a means to overcome social problems. Therefore, in the world of education, to prepare the generation to face the era of Society 5.0, improving the quality and quality of Human Resources (HR) is very necessary. To produce human resources to not only excel in academics and skills, but also to excel in ethics, morals, and personality. Starting from developing a strategy, in order to be able to be at the forefront. As a Muslim, an education system based on Islamic values, education that is not only worldly oriented, but also ukhrawi, how important learning based on Islamic values is in forming a generation that is smart in social,

spiritual, and intelligence. A generation that excels in science and technology, based on faith, to be ready to face the era of society 5.0.

Society 5.0 era emphasizes industrial revolution 5.0 education with a way of thinking that must always be accustomed to adapting in the future, namely analytical, critical, and creative. These three main abilities according to Puspita, et al. [4] needed to solve complex problems. This way of thinking is called higher order thinking (HOTS: *Higher Order Thinking Skills*). HOTS thinking is not mediocre thinking, but complex, tiered, and systematic thinking. HOTS abilities can be trained in the learning process in the classroom. Namely, by providing space for students to find the concept of activity-based knowledge. This can encourage students to build creativity and critical thinking. Teachers may choose various learning models, such as discovery learning, project based learning, problem based learning, and inquiry learning. All of these models teach and develop students' critical reasoning. HOTS habituation is also obtained with students always being introduced to and experiencing real-world situations firsthand. By recognizing the real world, students will recognize the complexity of the existing problems. Such as environmental issues, health, earth and space, as well as the use of science and technology in various aspects of life. Students are expected to be able to apply learning concepts to solve these problems. In this case the teacher acts as a facilitator for students to offer directions in finding solutions.

In line with this 5.0 era way of thinking, which is analytical, critical, and creative, the JAS (*Jelajah Alam Around*) approach, which is a comprehensive learning approach, combines a fun exploration and evaluation approach [5]. In line with this, Samitra [6] stated that the Surrounding Nature Exploration Approach (JAS) is a learning approach that in its activities utilizes objects, especially the surrounding environment directly through observation, discussion and report activities. Therefore, this JAS approach is suitable to be applied to learning *Capita Selecta Zoology*. This is because the Natural Surroundings approach (JAS) has 6 important principles, including 1) exploration, 2) constructivism, 3) science processes, 4) learning community, 5) bioedutainment, and 6) authentic assessment [7]. These six main principles, when applied consistently, are in line with the 5.0 era way of thinking, namely analytical, critical, and creative.

Based on the problem, the importance of students think the era of 5.0, the study aims 1) to describe the implementation of the

lecture topic *Capita Selecta Zoology* who use the approach JAS; 2) Analyze the suitability of the 6 principles JAS approach to think analytically, critically, and creatively 5.0 era. This is because of his knowledge can be replaced by technology (age 4.0), while the application of soft skills and hard skills which each learner can not be replaced by technology, which in the Revolution industry 5.0 in the world of education emphasizes the educational character, moral and exemplary, So expect, a danya the new system in this era of the role of teachers / lecturers will not be replaced by technology. Because here there is the role of teachers / lecturers who can never be replaced by technology, including direct interaction in the classroom, the emotional bond between teacher / lecturer and student / student, and also cultivation of character and the example of a teacher / lecturer. Results of lectures presented by preparation, enforceability, and reporting, both *Lesan* in discussions / seminars and written about the topic *Capita Selecta Zoology* at the Field Practicum Course Learning Resources conducted Biology student, then analyzed descriptively.

## **Discussion**

### **Biology Learning Resources Practicum Lecture Planning Concept (PLSBB)**

Description of the Biology Learning Resources Practicum Course (PLSBB) The topic of Zoology is to become a bridge to develop professional prophetic in students so that the characteristics of *siddiq*, *amanah*, *fathonah*, *tablegh* can grow after exploring the environment as a source of learning biology (zoology), to always be *istiqomah*, uphold commitment, work ethic that is increasingly qualified, care and concern for others and the environment.

The purpose of the Zoology Topic Biology Learning Resources Practicum Course is for students to get factual and contextual experiences that can make a meaningful lecture process for student life, so that students can design local wisdom and potential in Lampung Province to be an applied biology learning resource for students. learning in universities and schools.

Approach and Lecture Process for Biology Learning Resources Practicum (PLSBB) The topic of Zoology is Exploring the Surrounding Nature (JAS). The main activities in the 6 main component characteristics of JAS, include: 1) Exploration; 2) Constructivist; 3) Process science; 4)); *Learning communities*; 5) Bioedutainment; 6. Authentic assessment.

At the beginning of the lecture, a lecture contract discussion was held, to mutually agree on the material and the division of groups and assignments. The group is based on 5 material topics that support the material topics in the Postgraduate Biology Education curriculum at the University of Muhammadiyah Metro, including: 1) Botany; 2) Zoology; 3) Environmental Biology; 4) Bioremediation; 5) Biotechnology, each of which is under the umbrella of Local Wisdom and Potential as Biology Learning Resources. Although student assignments are divided into groups, all students are required to understand the five kinds of material topic areas, with the hope that students gain empirical experience in all lecture material comprehensively.

Planning lectures by utilizing this environment is in accordance with Ministerial Regulation [8], that in the Regulation of the Minister of Education and Culture of 2014 article 11 point 3 states that holistic means the learning process encourages the formation of a comprehensive and broad mindset by integrating excellence and local and national wisdom. The irony, as stated by Susilo [9] is the fact that in most schools, they have not utilized the natural environment as a source of learning in their learning, especially the potential of learning resources in their respective regions. The use of local-based learning materials and media is still limited to the school environment and has not utilized local potential. In line with the opinion of Jayanti, et al [10], that most students consider it necessary to integrate local potential and wisdom in biology learning.

These opinions give meaning, the importance of learning to take advantage of local advantages and wisdom, with the hope that a comprehensive and broad mindset will be formed. Students learn contextual objective according to reality and close to the nature where they live, so that it will be more possible to love their homeland as well as provide insight to be responsible for developing it wisely.

### **Implementation of PLSBB Lectures in Class**

The learning activities took place 16 meetings, with 1 credit per meeting, which was divided into 2 sessions, namely 8 meetings in the classroom, and 8 meetings to carry out practice in the field. The activity of the first session, begins with a case study-based discussion reviewing various updated journals for the next project activity (group) as well as providing the concept of material for Local Wisdom and Potential as a Biology Learning Resource by the lecturer. In the next five meetings, each group of students designed a JAS-based field

activity instrument according to their field of work. So that a draft of the field instrument was produced to be presented in class, discussed, and received input from fellow students and lecturers. The format of the field instrument is as follows.

a. Formulating Goals:

Doing scientific work by exploring the physical, social, technological, and cultural environment to find the concept of "X" comprehensively.

b. Determining the Study Location:

Choose one of the designated study objects to carry out scientific work by exploring the physical, social, technological, and cultural environment to find the concept of "X" thoroughly.

c. Ways of working:

1. Determine the object of study "X" to be explored to find the concept comprehensively;
2. Carry out main activities in the 6 main component characteristics of JAS, including:
  - a) Exploration
  - b) Constructivist
  - c) Science process
  - d) *Learning community*
  - e) Bioedutainment
  - f) Authentic assessment
3. Activity 1. "Exploration": make observations that involve integrated activities of the five senses, on the physical, social, cultural, and technological environment around the selected location, then:
  - a) Export one/some of the study objects "X",
  - b) relate the object "X" to the socio-cultural (disease, pollution, certain effects)
  - c) connect object "X" by technology (certain benefits for the welfare and development) To obtain data on "exploration" activities, the activities that you can do include:
    - 1) Observe habitat, distribution/distribution (influenced by climate & abiotic factors) and environmental characteristics "X".
    - 2) Observe the body profile, morphological & anatomical structure: body shape, body symmetry, division of body region, body wall, body organ components, digestive system, respiration, transportation, excretion,

regulation, skeletal, movement, reproduction and development, life cycle.

- 3) Pay attention to possible additional characteristics/characteristics, for example: uniqueness, body defense equipment, response and adaptation to the environment and other populations.
  - 4) The effect on humans: a. Manfaat positive, b. Negative effect, c. Possible opportunities/further development related to its characteristics
4. Activity 2. "Constructivist": the objectives of this activity are: a) construct concepts to gain knowledge about "X" being explored; b) Construct their own knowledge so that the knowledge they acquire is factual. The factual knowledge they get is formulated from their experiences when interacting with nature. So that students: know, understand, apply, analyze, evaluate, and create. To be able to construct the concept, among the activities that can be done are:
- a) Tracing the origin of the object "X" explored
  - b) Tracing the explored "X" position by kinship and in its classification system
  - c) Connecting the habitat characteristics and survival needs of "X" explored
  - d) Analyzing the relationship between the structure and function of the body of the object "X" being explored
5. Activity 3. "Science Process": The scientific process or process of scientific activity begins when students observe facts in their surroundings. The facts found in the environment by students are able to bring up problems to find solutions or solutions. Problem solving is done through a process called the scientific method, namely: Observing, formulating problems, formulating hypotheses, conducting experiments, and drawing conclusions. Basic process skills consist of observing, classifying, predicting, measuring, inferring, and communicating skills. Integrated skills in scientific process activities start from skills to identify variables to conduct experiments. The integration of science process skills is able to develop students' critical and creative thinking skills. The scientific process activities that can be carried out are:
- a) Formulate the problems found related to the results of observations and searches of the object "X" being explored



- b) Formulate hypotheses based on the critical theoretical induction process
  - c) Choosing alternative tools, materials, and treatments for hypothesis testing
  - d) Designing a mini research to test the hypothesis
  - e) Analyzing data from mini research
  - f) Formulating conclusions
  - g) Communicating in writing and orally regarding the results of the mini research
6. Activity 4. "*Learning Community*": The results obtained learners learning is done through collaboration with others; Mutual sharing between friends, between groups, and between learners who knows the uninitiated; The learning community/group is heterogeneous. Learning community activities that can be done:
- a) Conducting group discussions when carrying out each stage of the science process
  - b) Conduct discussions with small groups and classes when communicating/reporting the results of mini research
  - c) Creating a network for sharing information and discussions related to mini research and the object being studied
7. Activity 5. "*Bioeducationment*": learning package strategy becomes more enjoyable biology: biology, education, and entertainment; science and science discoveries, work skills, cooperation, educational games, competitions, challenges and sportsmanship can be one solution in addressing the biological development of current and future; Multimetode integrated lectures, discussions, educational games, experiments, and simulations (role playing), so that the effective and efficient learning. Bioeducationment activities that can be done:
- a) Creating mini research product creations can be in the form of images, articles, sketches, or others
  - b) Creating creations teaches concepts found in exploration and mini research results
  - c) Conduct community service according to the target regarding the application of exploration results and mini research.
8. Activity 6. "*Authentic Assessment*": the process of collecting various data that can provide an overview of the learning development of students, carried out before, during, and after

the learning process in an integrated and integrated manner in learning activities so that students who have learning difficulties can be detected as early as possible; emphasize the learning process; Authentic assessment is carried out on assessments to measure the skills and performance of students, carried out continuously, integrated, and can be used as feedback for them.; Examples of authentic assessment include assessment of project activities, homework, student work, student presentations or performances, demonstrations, reports, reflection journals, written works. Authentic assessment activities that can be done:

- a) Keep a self-reflection journal at every step of the science process
  - b) Prepare a written report on the results of activities (mini research)
  - c) Compile the final portfolio of activities
  - d) Making articles or the like (sketches, audiovisuals) as other mini research products.
9. Attach Indonesian & foreign articles that are used as references for understanding the concepts and instruments of field activities according to the topics determined according to the group of fields of study.

Student work within the framework of carrying out lectures in the classroom by compiling field instruments has certainly encouraged students to think analytically, critically, and creatively. Moreover, in each item A, B, C number 1-9, students are required to be able to formulate alternative activities and products produced in each of their JAS activities. Analytical thinking is characterized by the ability to solve problems vertically (convergence). As stated by [11], namely the stage of thinking of students in solving problems where, students have three aspects of thinking, namely, aspects of sorting (distinguishing), aspects of organizing (connecting), and aspects of attributing; which is generally followed by the ability to think synthetically, namely the ability to think of students in solving problems where, students have three aspects of thinking, namely, creating unique communication in solving problems, creating unique solutions, and being able to apply problems in other forms.

Critical thinking, according to Robert Ennis in Alec Fisher [12] is thought sensible and focused reflection to decide what should be believed or done. In essence when thinking human being learning

to use the capacity to think intellectually and at the moment comes along thinking of alternatives and solutions to problems faced. When thinking, humans are learning to use their thinking abilities intellectually and at the same time thinking about alternatives and solutions to problems faced so that when thinking humans can decide what to do because decision making is part of critical thinking. Confirmed by the Chaldeans [13] critical thinking is considered an active, continuous and meticulous about a belief or form of knowledge that is acceptable to include supporting reasons and rational conclusions. Therefore, to achieve a maximum learning results in learning activities teachers should be more often motivate students and provide opportunities for students to be active, creative, critical and can develop students' interaction in order to understand the material presented in the learning process in schools [14].

About creative thinking, Fidyawati [15] defines as the ability of the combination of logical thinking and divergent thinking which is based on intuition but still in consciousness. In line with this thought, Andong [16], divergent thinking is an important component of create on that generate different ideas on an issue or question that has many alternative solutions. Divergent thinking derived from the provision of a number of tasks that include problem solving to seek multiple solutions. Similarly, the opinion expressed by Munandar [17], which suggests creative thinking as the ability to see all kinds of possible solutions to a problem, then one way of thinking that is still not getting the attention in formal education. Therefore, troubleshooting can be used into the stages of creative thinking ability, which involves three components of the characteristic features of creative thinking is fluency (*fluency*), flexibility (*flexibility*) and novelty (*novelty*).

Paying attention to the steps of JAS activities number 1-9 allows students to demonstrate and realize analytical, critical and creative thinking. Especially after they planned, followed by a discussion presentation with friends and lecturers, getting the opportunity to get input and open their horizons, so that from this planning they have been led to the 5.0 era. The end of the implementation of class activities ends with UTS (Middle Semester Examination), students revise field activity instruments according to input and choice of objects to be studied in field practice activities.

### Implementation of PLSBB Field Activities

At this stage the student group had agreed on objects and locations PLSBB activities. Student has compiled relevant committee in charge of the field to reporting and seminars, so that in this case the lecturer / teacher quite as facilitators who assist field activities according to the field. Conducting scientific work by exploring physical and social environment, technology, and culture to discover the concept of animal zoology tertunjuk comprehensive review of all the objects of study civet civet coffee, which is located in the *Home Industry Kopi Luwak Radja. Jl. Raden Intan Gg. Pekonan, Liwa Confessing Way West Lampung*. Of field activities, especially related to the field of Zoology (*Capita Selecta Zoology*) results of field studies and analysis of the results obtained JAS approach, behavioral 5.0 era in the field of education, namely to think analytically, critically, and creatively is as follows.

### The Results of Observation of the Civet Weasel Object

The object of study taken is located at the Home Industry of *Kopi Luwak. Jl. Raden Intan Gg. Pekonan, Way Confesses Liwa, West Lampung*. The objective formulated in this activity is to carry out scientific work by exploring the physical, social, technological, and cultural environment to find a comprehensive zoological concept of designated animals.

**Table 1. Analysis of the Relationship between the JAS Approach and the Behavior of Era 5.0 in Zoological PLSBB Activities**

NO	JAS APPROACH				5.0 ERA MINDSET			POSITIONS
	ACTIVITY	AIM	DUTY	PRODUCT	ANALYSIS	CRITICAL THINKING	CREATIVITY	
1	Exploration	make observation that involve integrated activities of five	data collection in the field; explore the taxonomy of ferrets, explore where they live, food,	Various knowledge about ferrets' physical form, eating behavior	☑	☑		Embedded attitude of empathy, scientific, siddiq, trust, fathon

		sense s, on the physi cal, social, cultur al, and techn ologic al envir onme nt aroun d the zoolo gy field obser vation locati on	feces, unique ways of eating, feed conditions , faecal conditions	ior, restin g, fun, sniffin g, locom otion			ah, tabligh
2	Constr uctivis t	Const ructin g conce pts to gain knowl edge about somet hing, wease l, thus obtain ing factua l knowl edge to formu late	Trace the object being explored (weasel): origin, position, habitat, necessitie s of life, structure and function of body organs	Data and under standi ng of the object being explor ed	?	?	Confid ent, scienti fic, thorou gh, discipl ined, orderl y, siddiq, trustw orthy

3	Science Processes	Carry out work with the scientific method; Carry out basic and integrated science processes	Observation, formulation of the problem, hypothesis, experiment, draw conclusions;	Data and understanding of the object being explored	?	?	?	Confident, scientific, thorough, disciplined, orderly, careful, work effectively and efficiently, thrifty, positive self-character
4	Learning community	Carry out collaborative activities, form a learning community to share and exchange experiences	Conduct discussions when conducting the scientific process; communicate- give form a sharing network for those being studied	Deep and broad data and understanding of the object being explored	?	?	?	Confident, scientific, thorough, disciplined, orderly, careful, work effectively and efficiently, thrifty, positive self-character

5	Bioeducation	Strategies to make biology learning more fun	Create product creations; Develop exploration and mini research; carry out socialization and community service	Creative products	?	?	?	Confident, scientific, thorough, careful, orderly, disciplined, work effectively and efficiently, frugal, positive self-character
6	Authentic assessment	Strategies to collect data about the development of students; Learning becomes integrated, integrated; Authentic scoring	Carry out project-based activities, homework, student presentations, student performances, demonstrations	Reports, reflection journals, scientific papers, reflection journals, homework, student work	?	?	?	Confident, scientific, thorough, disciplined, orderly, careful, work effectively and efficiently, frugal, positive self-character

g  
syste  
m can  
be  
pursu  
ed

er,  
siddiq,  
trustw  
orthy

---

Pay attention to Table 1. Provide an understanding that the principles of the JAS approach have the potential to foster analytical, critical, and creative thinking. As [18] states, that as educators in the era of society 5.0, teachers must have skills in the digital field and think creatively, teachers are required to be more innovative and dynamic in teaching in the classroom. Therefore, there are 3 things that educators must use in the era of society 5.0., including: 1) *Internet of things* in the world of Education (*IoT*), 2) *Virtual/Augmented reality* in education, 3) Utilization of *Artificial Intelligence* (AI) in the world of education to find out and identify the learning needs needed by students. In line with the opinion of experts regarding the 5.0 era, [19], educators must also have 21st century life skills, namely having *leadership skills, digital literacy, communication, emotional intelligence, entrepreneurship, global citizenship, team working and problem solving.*

The priority of 21st century education expertise is currently known as the 4Cs which include *creativity, critical thinking, communication and collaboration. Educators in the society 5.0 century must be driving teachers who prioritize students over themselves, take the initiative to make changes to their students, take action without prompting, continue to innovate and take sides with students. It's something to be proud of, that some experts say that in the 5.0 era, the role of teachers that doesn't exist in technology includes direct interaction in the classroom, emotional bonding between teachers and students, character building and teacher modeling.*

The industrial revolution 5.0 in the world of education emphasizes character, moral and exemplary education. This is because the knowledge possessed can be replaced by technology while the application of soft skills and hard skills possessed by each student cannot be replaced by technology. Of course, this statement is an appreciation for educators to function optimally, because they directly get a strategic role in the 5.0 era.

Based on statements [18], [19], [20], lectures with the JAS approach show the potential for students to implement 3 important



ways of thinking in the 5.0 era. namely being led to think analytically, critically, creatively. Besides that, because the role of the teacher can never be replaced by technology, as vice versa in the era 4.0 technology and digitization are glorified, era 5.0 is important to involve the role of teachers/lecturers including direct interaction in the classroom, emotional bonds between teachers and students, and also the cultivation of the character and example of a teacher, then the potential to develop students' emotions, character, even etiquette, devotion, and sincerity which are now starting to be abandoned, optimistic that in the 5.0 era can be developed, because this cultivation will not be obtained from technology, so it is certain, educators will always be needed.

### **Conclusion**

Based on the tracing of the lecture activities of the Biology Learning Resources Field Practicum on the topic of capita selecta zoology with an in-depth study using the JAS (Jelajah Alam Around) approach to the coffee-producing civet civet object, it can be concluded that the principles of the JAS approach include 1) exploration; 2) constructivist; 3) process science; 4) learning communities; 5) bioedutainment; 6) authentic assessment, has the potential to foster analytical, critical, and creative thinking. Therefore, the selection of learning approaches can be an alternative effort to bridge students to live life in the era of *society* 5.0.

### **Reference**

- [1] R. Anggraheni and R. D. Astuti, "Revitalisasi Nilai-Nilai Islami dalam Edukasi guna Mempersiapkan Generasi Menuju Era Society 5.0 sebagai Bagian dari Strategi Rekonstruksi Kejayaan Peradaban Islam," Pros. Konf. Integr. Interkoneksi Islam Dan Sains, vol. 2, pp. 31–34, 2020, [Online]. Available: <http://sunankalijaga.org/prosiding/index.php/kiiis/article/view/368>.
- [2] Badan Pusat Statistik, "Hasil Sensus Penduduk 2020," 2021.
- [3] M. Fukuyama, "Society 5.0: Aiming for a New Human-centered Society," Japan SPOTLIGHT, no. August, pp. 8–13, 2018.
- [4] Y. Puspita, Y. Fitriani, S. Astuti, and S. Novianti, "Selamat Tinggal Revolusi Industri 4.0, Selamat Datang Revolusi Industri 5.0," Pros. Semin. Nas. Pendidik. Progr. Pascasarj. Univ. PGRI Palembang, pp. 122–130, 2020, [Online]. Available: <https://jurnal.univpgri->

- palembang.ac.id/index.php/Prosidingpps/article/view/3794/3565.
- [5] A. M. Santika, D. N. Budiningsih, and C. S. M. Yuwono, "Pendekatan Jelajah Alam Sekitar (JAS) Berbasis Pelestarian Jalak Bali terhadap Kepedulian Lingkungan dan Hasil Peta Kognitif Siswa," *J. Santiaji Pendidik.*, vol. 7, no. 1, pp. 55–66, 2017.
  - [6] D. Samitra, "Peranan Pendekatan Jelajah Alam Sekitar (JAS) Terhadap Keterampilan Proses dan Hasil Belajar Biologi Siswa Kelas X SMA Negeri 5 Lubuklinggau," *J. Bioedukatika*, vol. 4, no. 2, p. 8, 2017, doi: 10.26555/bioedukatika.v4i2.5024.
  - [7] S. Alimah and A. Marianti, *Jelajah alam sekitar: pendekatan, strategi, model, dan metode pembelajaran biologi berkarakter untuk konservasi*, no. December. 2016.
  - [8] Permendikbud, *Permendikbud RI No.49 Tahun 2014*. 2014, p. 31.
  - [9] M. J. Susilo, "Analisis potensi lingkungan sekitar sebagai sumber belajar biologi yang berdayaguna," *Procending Biol. Educ. Conf.*, vol. 15, no. 1, pp. 541–546, 2018, [Online]. Available: <https://jurnal.uns.ac.id/prosbi/article/view/32606>.
  - [10] U. Nur Afinni Dwi Jayanti, H. Susilo, and E. Suarsini, "Analisis Kebutuhan Bentuk Sumber Belajar dan Media Pembelajaran Biologi Berbasis Potensi Lokal untuk Kelas X SMA di Provinsi Lampung," *Pros. Semin. Pendidik. IPA Pascasarj. UM*, vol. 2, pp. 591–599, 2017.
  - [11] A. Assegaff and U. T. Sontani, "Upaya Meningkatkan Kemampuan Berfikir Analitis Melalui Model Problem Based Learning (Pbl)," *J. Pendidik. Manaj. Perkantoran*, vol. 1, no. 1, p. 38, 2016, doi: 10.17509/jpm.v1i1.3263.
  - [12] A. Fisher, *Berpikir Kritis "Sebuah Pengantar."* Jakarta: Erlangga, 2008.
  - [13] S. Kasdin, *Critical Thinking "Membangun Pemikiran"*. Jakarta: Pustaka Sinar Harapan, 2012.
  - [14] R. Rachmadtullah, "Kemampuan Berpikir Kritis Dan Konsep Diri Dengan Hasil Belajar Pendidikan Kewarganegaraan Siswa Kelas V Sekolah Dasar," *J. Pendidik. Dasar*, vol. 6, no. 2, p. 287, 2015, doi: 10.21009/jpd.062.10.
  - [15] V. Fidyawati, *Kemampuan Berpikir Kreatif Siswa pada Pembelajaran Matematika dengan tugas pengajuan Soal Problem Posing*. Surabaya: UNESA, 2009.
  - [16] A. Andong, "Pemecahan Masalah Matematika Divergen Menggunakan Proses Berpikir Siswa Yang Memiliki Gaya Kognitif Fd/Fi," *J. Pendidik. Mat.*, 2014.

- [17] U. Munandar, *Pengembangan Kreativitas Anak Berbakat*. Jakarta: PT Rineka, 2009.
- [18] D. Nurani, "Menyiapkan Pendidik Profesional di Era Sosial 5.0," 2021.  
<http://ditpsd.kemdikbud.go.id/artikel/detail/menyiapkan-pendidik-profesional-di-era-sosial-50>.
- [19] A. Mukhlisin, D. I. Era, and R. Industri, "Kepemimpinan Pendidikan di Era Revolusi Industri 4.0," *J. Tawadhu*, vol. 3, no. 1, pp. 674–692, 2019.

# **Improved internal quality assurance system based on iso 9001:2008 with document management control (dmc) and web-based applications**

Hermien Tridayanti· Bayu Putra Airlangga

## **Introduction**

The development of the business world is moving so fast, almost all business segments provide various opportunities and challenges, including implications for the demands for skilled workers with abilities that are in accordance with professional standards.

Universities as labor producers are required to be able to respond to this by preparing facilities and infrastructure that are supported by increasing the ability of their human resources in the field of Information Technology. Improve the quality of education and teaching by building a perfect quality assurance system in higher education and establishing a long-term mechanism to continuously improve the quality of education [1].

Learning from the existence of the Higher Education Quality Assurance System, since 2003, there has been an education reform by making many changes regarding the system, culture and management figure. Changes that occur include, quality culture has a significant influence on changes in a person's attitude. At first, the internal quality management system that had been implemented was felt to be sufficient to contribute to the changes needed. However, with the growth and development of the organization, making decisions that can be given quickly and accurately has become a demand. Quality Management System (QMS) is expressed as a systematic set of procedures, policies and operations, maintained and controlled by the company to achieve its goals and continuous improvement in the overall system [2].

The competency approach in principle can imply a guarantee system internal quality is not fully operational, in the sense that it is suitable for one particular situation but not necessarily suitable for another situation. In addition, SIPENJAMU becomes rigid from the elements of adaptability development, because it places too much emphasis on know how and pays less attention to know why. Document Management Control, in general, is to get reports on time, ease of operation, maintenance and the possibility to be improved and expanded (easily adapted to the development and needs of the College). The use of computer technology that implements proper

design, implementation and operation, both in terms of hardware, software and brainware, will easily adapt to the standards of the world's higher education needs, both nationally and internationally [3].

Therefore, the two approaches, namely the competency-based approach and the broad-based approach, are accommodated. There are four main characteristics in the internal quality assurance system, namely: (1) simple, meaning that it only contains general principles that can be developed further; (2) flexible, in the sense that it can be adapted to the demands of needs; (3) dynamic in nature, can be developed in a sustainable manner; and (4) relevance, must always be able to show good performance. In implementing the Higher Education Internal Quality Assurance System, experience has shown that although it has flexible and dynamic characteristics, because it was designed and developed with the old paradigm, it is not conducive enough to accommodate the insights and missions contained in the new paradigm which is different from the previous one. So improvements are needed. Therefore, by still referring to the foundation, program and development of an internal quality assurance system that uses the basic principles, namely: (a) competency-based; (b) basic and strong; (c) learning through direct experience, (d) independent learning, (e) applying feedback and reinforcement. All QMS processes can be verified and updated faster and more precisely. Added benefit of implementing new simulation methods - cost reduction and continuous improvement for QMS [4].

The concept of an internal quality assurance system is a systemic activity of quality assurance of higher education in higher education by universities (internally driven), to oversee the implementation of higher education by universities themselves on an ongoing basis (continuous improvement). Furthermore, the main issue is how the internal quality assurance system that has been implemented in SIPENJAMU will be further improved in its use by adding a Web-based Document Management Control application to speed up the decision-making process in both academic and non-academic circles. Facing up to the needs of work-based learning requires actions that are owned by and may create anxieties for institutions that hide their resistance to change under the cloak of work-based learning [5].

Many integrated systems are being used and are being implemented, even by various groups in relation to performance achievements in higher education. On the other hand, the

development of information technology and multimedia comes so fast, and it cannot even be denied that the use of information technology has become a necessity for every human being today. With this guide, it is hoped that the preparation and activities related to SIPENJAMU can be carried out and monitored wherever the user is, so as to optimize the performance of individuals and related units, among others: a) The existence of infrastructure in the form of Document Management Control application will be very useful in efforts to improve performance in academic and non-academic spheres. By using this method, you will also familiarize yourself with the use of the online environment which has now become a basic technical skill, where every Lecturer and Personnel will be familiar with the process of searching, receiving & sending data as well as utilizing the data available on the WEB, b) The formation of Performance Management with the integration of management practice which includes employee assessments, including setting performance standards and ensuring organizational goals can be achieved. As a service to the academic community, universities must have an assessment and evaluation of their activities to ensure the quality of services offered and user satisfaction. As a result, one of the main challenges for libraries is to define and decide on the most appropriate mechanisms to improve and ensure the quality of their services, [6].

In a quality management system that refers to ISO 9001:2008 as a general requirement, the organization must establish, document, implement and maintain a quality management system and continuously improve its effectiveness in accordance with the standard requirements, where the organization must : 1) Establish the processes required in the quality management system and implement them in all units within the organization, 2) Define the sequence and interaction of these processes, 3) Determine the criteria and methods needed to ensure the effective operation and control of the process, 4) Ensure the availability of resources and information necessary for the operation and monitoring of the process, 5) Monitor, measure and analyze the process, 6) Take the necessary actions to achieve results consistent with planning and continuous improvement. The ISO 9001 standard provides a common set of requirements for implementing quality management system (QMS) independently of the organization's activities. However, the education sector has specificities that distinguish it from other manufacturing and service sector activities, [7].

Guidelines ISO 9001:2008 Based on IWA 2:2007 in clause 4.2.3 the purpose of document control is to ensure that all documents contained in the quality management system are continuously updated and available only in the latest version. Educational institutions should establish documented procedures for: 1) Editing, reviewing in internal documents, including their identification and revision status, 2) Control of external documents, preferably those relevant to regulations, which should always be updated, 3) Ensure that documents are available to all personnel in organization, 4) Manage and control ownership documents from customers, 5) Ensure graduation tracking as one of the services provided by the organization. 6) Verify the fulfillment of the requirements in determining the stages of the process. ISO 9001 standard in higher education institutions (HEIs). There is a goal to understand: What are the main motives for implementing quality management (QM) tools analyzed in academic institutions, R. [8].

## **Discussion**

Development of SIPENJAMU based on Document Management Control requires experts in the fields of content, andragogy, technical aspects and manufacture, so a multi-disciplinary team based approach is needed. This research is based on a development research design with implementation procedures grouped into two stages. The research design is as follows: 1) The first stage is to develop a survey design and a development plan through brainstorming and focus group discussions, and 2) The second stage, research development and experimental research with the design of Document Management Control, is a web-based application.

Meanwhile, for the preparation of synchronization of Document Management Control materials that are relevant to the needs of Higher Education, selection of documentation flows, and integration with the ISO 9001:2008 quality management system based on IWA 2:2007, as well as the preparation of SOPs Based on Interactive Computer Simulations and Web Applications, which orientation of relevant competency skills is carried out by referring to the 4 D model, which includes define, design, develop, and disseminate. Electronic Document Access Control and Management has become a challenge as large-scale organizations and governments are transitioning towards electronic media platforms. Electronic media includes most of the electronic documents used for easy sharing and storage, [9].

The define stage is basically the stage of determining the format and substance of the product to be compiled (document mapping, document distribution flow arrangement). In this case, it is carried out through three sub-stages, namely : a) Needs analysis stage, b) Development analysis stage, and c) Expert judgment stage. Current and possible practical approaches to the organization of document and order control, covering all stages and document processes: receipt, registration control, registration, distribution, delivery to consignee, consideration, approval, inspection, approval, decision making, , delivery to the document writer needs analysis conducts field surveys and conducts initial designs, [10].

By observing the flow of Narotama University's internal mailing system to synchronize relevant materials and operational needs. Second, development analysis, namely making a design of the documentation flow based on the requirements in ISO 9001:2008 based on IWA 2:2007. The results of the two methods are then combined, resulting in a document management control that can provide clarity of communication flow accompanied by supporting documents, so that it will speed up the decision-making process. To ensure compliance with the performance achievements that have been determined, they are reviewed in focus group discussions and followed by expert judgment.

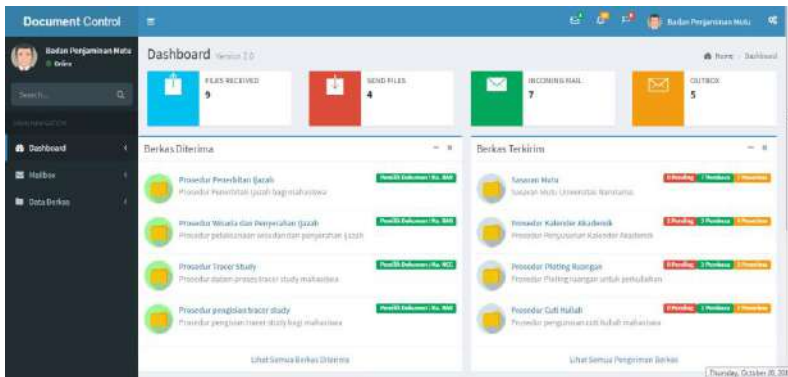
Expert judgment stage, experts involved in focus group discussions and expert judgment are experts in various fields, including higher education, internal quality assurance systems and information and communication technology. Support Based on these data, an effective way for universities to strengthen the construction of connotations and improve the quality of education and teaching is to build a perfect quality assurance system in universities and establish a long-term mechanism to continuously improve the quality of education, [1].

Thus, at the definition stage, a basic framework of research products will be produced that has gone through the discussion stage, including: formats, SOPs, and work instructions that are synchronous and relevant to the internal mailing system. Based on the basic framework, then proceed to the development stage, namely the creation of standard operation procedures (SOP) and work instructions (IK) based on Document Management Control with Web applications. Based on the basic framework, then proceed to the development stage, namely the creation of standard operation



procedures (SOP) and work instructions (WI) based on Document Management Control with Web applications.

The expert review stage is intended to obtain input on the adequacy of the design developed by the researchers based on the needs of the internal quality assurance system. In addition, this step is intended to obtain validation about : 1) Adequacy of design, 2) Document distribution flow, 3) Relevance of content contained in Document Management Control, 3) The quality of the layout is in accordance with the indicators used in the review, so the experts involved in this activity include: information technology, quality assurance, and universities.



**Figure 1. Dashboard Document Management Control**

Next, the Document Management Control that has been prepared is tested. At this stage the research product is actually nearing the final stage. However, to obtain empirical evidence that the research product is suitable for use, some of the research products are tested in a system that is in the internal mailing system in all units, both academic and non-academic (disseminated stage). The trial implementation was carried out by entering data in Document Management Control, then analyzing a process in the SOP in each Academic and Non-Academic unit. In addition to the method of preparing and making SOPs mentioned above, it is also necessary to carry out staff development at the implementation stage, to simplify and expedite the change from traditional courses to interactive computers and web applications.

## Conclusion

The Document Management Control application can be a support for the operational process, this can be seen from the DMC layout which speeds up finding out the existence of a document. This application strongly supports the quality management system, where all documents will be distributed if it has been approved by the document holder. In this study based on the Quality Management System ISO 9001:2008 based on IWA 2:2007, in the second year planning it will be updated to ISO 9001:2015. So that the DMC will be adjusted to the document distribution requirements, both academic and non-academic.

## References

- [1] W. Zhang and M. Li, "Construction and Practice of Internal Quality Assurance System in Colleges and Universities Based on Data Support," in *Advances in Intelligent Systems and Computing*, 2021, vol. 1342 AISC, doi: 10.1007/978-3-030-70042-3\_12.
- [2] M. Usman *et al.*, "Investigating the Role of QMS implementation on customers' satisfaction: A case study of SMEs," in *IFAC-PapersOnLine*, 2019, vol. 52, no. 13, doi: 10.1016/j.ifacol.2019.11.504.
- [3] H. Tridayanti, B. A. Putra, and S. Nilowardono, "Development of Internal Quality Assurance System Iso 9001: 2008 based on Iwa 2: 2007 using web-based Document Management Control (Dmc) applications," in *Proceedings of the International Conference on Industrial Engineering and Operations Management*, 2019, vol. 2019, no. MAR.
- [4] I. I. Livshitz, P. A. Lontsikh, O. M. Stefanovskay, E. Y. Golovina, and Y. V. Kibirev, "Simulation Method within Integrated Management Systems and Affects for Digital Enterprises Processes Support," 2019, doi: 10.1109/ITQMIS.2019.8928308.
- [5] P. Gibbs and P. Armsby, "Higher education quality and work-based learning: Two concepts not yet fully integrated," *Qual. High. Educ.*, vol. 16, no. 2, pp. 185–187, 2010, doi: 10.1080/13538322.2010.485729.
- [6] N. B. Mola, "The use of ISO 9001 quality standard in higher education institution libraries," *Fac. Bibliotecon. i Doc. Univ. Barcelona*, vol. 19, no. December, 2007.
- [7] L. El Abbadi, A. Bouayad, and M. Lamrini, "ISO 9001 and the Field of Higher Education: Proposal for an Update of the IWA 2 Guidelines," *Qual. Aproches High. Educ.*, vol. 4, no. 2, pp. 14–19,

- 2009.
- [8] R. Kasperaviciute, "Application Of ISO 9001 And EFQM Excellence Model Within Higher Education Institutions: Practical Experiences Analysis," *Soc. Transform. Contemp. Soc.*, vol. 2013, no. 1, pp. 81–92, 2013.
  - [9] R. Singru, P. Bhandari, K. Patel, P. Mane, and C. Gulhane, "Efficient electronic document access control management using natural language processing," 2020, doi: 10.1109/I-SMAC49090.2020.9243433.
  - [10] M. ABSATTAROV, "ABOUT THE ORGANIZATION OF CONTROL OF DOCUMENTS AND ORDERS IN THE CONDITIONS OF REMOTE WORK," *Public Adm. Civ. Serv.*, no. 2–77, 2021, doi: 10.52123/1994-2370-2021-50

## **Benefiting from Online Learning as a Shortcut to Address Society 5.0 Challenges: EFL Students' Perspective**

Hersulastuti<sup>53</sup>

### **Introduction**

In times of the COVID-19 crisis, which is still in continuation, higher education institutions all over the world have been migrating from conventional instruction to online learning programs [1]. Adoption has been inevitable to prevent the transmission of this virus and to enable students to continue their studies while they are physically isolated. Undoubtedly, it is the best solution for making learning accessible. The term "e-learning or online learning" refers to acquisition and application that is primarily facilitated and delivered through electronic means, either synchronously or asynchronously [2] [3]. Similarly, online learning is best defined as the utilization of information and communication technology to facilitate access to online educational and instructional resources [4].

Many prior studies have revealed the benefits, as well as some drawbacks, of undertaking online learning. In a positive way, online learning can serve as a panacea in the time of the coronavirus crisis [5]. Khan's study has found that because of its extensive use in higher education, online learning has given the majority of people in the community access to courses at any time and from any location. In this case, flexibility, distribution in each location, and openness are three positive characteristics of the e-learning system [6]. Another study has indicated that the majority of the respondents expressed favourable convenience with their online education. However, of all the obstacles encountered, time management was claimed to be the most difficult one [7]. Meanwhile, in Daniel's study, some obstacles of e-learning are related with connectivity, equipment, software, and training [8]. Another study discovered that both teachers and students perceive interacting online as time-consuming [9].

Certainly, the issue of online learning in higher education has compelled academic institutions to upgrade their curricula and has enhanced the implementation of innovative instructional methods and strategies. This should be done not only for handling the learning

---

<sup>53</sup> Universitas Widya Dharma Klaten

system due to the exist of the Covid-19 outbreak but for anticipating the dynamic changes in global education which might occur in the future. In developing the curriculum, higher education should be able to respond to the world's current needs. Hence, in such a transition, greater opportunities need to be provided to maximise students' potencies to become competent.

To accommodate the paradigm shift in education, the government, through the Minister of Education and Culture, has established the program with the tagline of "Freedom of Learning - Independent Campus." In this program, students are encouraged to make decisions to support them in becoming self-directed learners who take ownership of their own learning; as a result, learning autonomy is strongly promoted. Additionally, students are supported to acquire widerknowledge and transversal competencies needed to compete in the dynamic changes of the world. Through this model, they have opportunities to engage in different learning environments and societal interactions to develop their thinking skills, creativity, curiosity, self-confidence, collaboration skills, caring for others, personal values, and more importantly, problem-solving skills for life survival.

Due to the advancement of digital technology, today's world has no boundary lines. As a result, people worldwide have become more connected. On this account, new skills and technology in the framework of knowledge-based technology should be emphasized in education. Such adaptation is beneficial for welcoming the era of Society 5.0, which can be interpreted as a fundamental idea for a human- centered, technology-driven society that was initiated by Japan government to respond the global trends of Industrial Revolution 4.0. In this era, globalization and the rapid advancement of digital technologies such as the Internet of Things (IoT), artificial intelligence (AI), and industrial robots are transforming society in profound ways. [10], [11]. However, since the essence of the technology revolution in the era of society 5.0 is to humanize people, it will be essential to optimize an individual's intelligence to deal with the changes that will occur in society 5.0. Such drastic changes might invite challenges for an unprepared community. Therefore, it is still urgent to dig up more aspects of the integration of technology, specifically in education, to address those challenges.

This article was based on a qualitative mini-research using twelve EFL students' reflective journals, focusing on their experiences with online learning, and several literature sources to

shed light on the question: "how can EFL students get the benefit of using online learning to address the Society 5.0 challenges?" Though numerous articles have been published on similar topic, this current study adds a dimension that is still rarely examined by incorporating additional perspectives from EFL students into the transition to online learning, which can be used as a shortcut to address some of Society 5.0's challenges. Hence, this study can be used to fill the gaps in the data.

## **Discussion**

### **How Online Learning in Higher Education Matters**

In a simple interpretation, online learning is the process of acquiring and applying knowledge that is facilitated and transmitted primarily through electronic means either synchronously or asynchronously [12]. Similarly, online learning is a term that ascribes to the use of information and communication technologies to elevate learning in college degree. Highlighting this definition, [3] argues that it is the application ICT to facilitate access to online educational and instructional resources. Online learning, in the broadest sense, refers to any type of learning that is facilitated electronically. In a more limited sense, it is education that is facilitated by digitization.

In relation to the type of online system, [13] defines an entirely online mode as either "synchronous" or "asynchronous". The synchronous mode enables students to communicate with the instructor and other students simultaneously via the internet, utilizing tools such as video conference and live chat. The asynchronous mode consists of alternate online access between teachers or instructors and learners, or between learners and teachers. Using this mode, learners can login and download the material, or communicate with teachers or peers but instant feedback are not available at the same time [14].

In higher education institutions, much support must be facilitated for the integration of technology into learning. With technology advancement, various learning platforms are available to support learning, such as the use of learning management systems (LMS). LMS are a type of software that focuses on displaying, managing, tracking, and evaluating all online learning activities rather than on content. They can be either synchronous or asynchronous [13]. Due to its development, there are many types of LMS that can be accessed freely, ranging from: (1) *Moodle*- a web-

based LMS e-learning application that can be used as offline learning media in online form (web based) and offers various features that can be accessed through Android and IOS; (2) *Edmodo*-a personal microblogging media developed for instructors and students, with student privacy in mind, enabling instructors and students to share notes, links, and documents; (3) *Google Classroom*-a free web tool provides for schools to create, distribute, and grade assignments easier without the need for face-to-face meetings, and (4) *Schoology*: an innovative platform built and developed by the inspiration of social media for educational purposes to assist teachers in providing students with a broader range of communication opportunities so that they can more readily participate in discussions and collaborate in groups supplemented with a variety of media, including video, music, and graphics, which can increase students' interest.

Compared to traditional face-to-face courses and lectures, online learning offers numerous benefits. Students can choose learning resources that are appropriate for their level of expertise and interest. In certain circumstances, students can learn from anywhere as long as they have an internet connection and a computer device. They can work at their own pace with self-paced learning modules. Another advantage is that such learning offers flexibility to join discussion or conversation in live chat rooms with lecturers or friends remotely at any time they are available.

As reflected by the students' journal, all student-participants found online learning advantageously during the COVID-19 outbreak while they still had to maintain health protocol. They claimed that it was the best solution to make them continue learning. In the early years of the crisis, certainly, the shift from face-to-face instruction to entirely online modes required several adjustments for students, lecturers, and institutions. However, as there are some improvements in boosting public health, the college has been embracing blended learning as a method of delivering lectures by combining classroom face-to-face studies with online learning.

In most online learning environment, students-participants were engaged in Google Classroom and social medias, such as WhatsApp, Line, and Facebook, due to their convenience and ease of access. Others virtual modes, such as Google Meeting and Zoom Meeting, were found to be the most preferable tools for them. In such modes, they could have direct explanations from the lectures, present their group projects or assignments, employ live chats to ask or

clarify some points of the material as it was being presented by the lecturer, and most interestingly, they could communicate with their friends on screen as they had not seen each other for a long time.

Aside from various obstacles that occurred in the online learning, such as low connectivity, technical matters, the dismissal from the screen, time-consuming, and limited mastery of the material, nine student-participants could get a lot of experience in technology integration, promote their independence in learning, and increase their problem-solving skills. In the meantime, three of them claimed to have advantages in that they could interact virtually with their friends and exchange work. Such a finding strengthens previous studies that the proper usage of the learning platform opens up a whole new world of possibilities for both classroom and distant learning, fosters independent learning, makes course contents more accessible, encourages interaction among the course's various agents, minimizes abandonment, encourages dialogue, and increases interactive activities [15].

### **Society 5.0: Challenges and opportunities for EFL Students**

In interpreting the concept of Society 5.0, Rojas, Peñafiel, Buitrago, and Romero argue that it is a society focusing on people who can solve social problems through technologies built through the merging of cyberspace and physical space as a result of economic advancement [16]. In addition, referring to the goal of Society 5.0, Fukuyama reported that its objective is to create a human-centered society in which individuals can enjoy a high standard of living that is both active and pleasurable while also advancing economic development and resolving problems in society. [11]. If Society 4.0 enables everyone to have access to and exchange information on the internet, then Society 5.0 is a period in which all technology is integrated into humans themselves. It would be undeniable that such a shift brings many consequences and invites some challenges as well as opportunities for society. Therefore, to address the challenges and take advantage of opportunities, Indonesian society is required to develop several capabilities related to data, technology, and human literacy.

In the field of education, students should be encouraged to achieve a set of competencies to engage in the dynamic changes where soft skills and technology literacy are vital in their daily lives. These competencies, also known as 21st century competences or 21st century skills, are defined as (a) transversal: not directly linked to a



particular field but are applicable across many fields, (b) multidimensional: encompass knowledge, abilities, and beliefs, and (c) linked to higher order proficiencies: comprise the capacity to deal with complex issues and unexpected situations [17].

More specifically, in the EFL context, students must be endowed with twenty first century skills in order to refine their ability to think critically, creativity, communication, and collaboration qualities (4Cs). Based on the students' reflections, various activities were employed by lecturers to promote the development of the students' 4 Cs. To develop critical thinking skills, they were assigned to analyse and comprehend various texts, examine information from multiple sources, exchange opinions with their friends in discussion, formulate and draw conclusions. To promote creativity, they were challenged to create posters, make short videos for the final exam, or develop simple IT-based materials. To support the collaboration skills, students engaged in collaborating with others to generate works, accepting mutual responsibility or providing positive feedback to peers, and lastly, in developing communication skills, mostly when they were in face-to-face class, students were supported to perform role-play, drama, debate, write scripts or essay for advancing cohesion and coherence in oral and written input, as well as process and present information. All of the skills are still relevant to addressing the challenges of Society 5.0, where individuals will be connected with technology in all aspects of societal life. Moreover, as the activities can be delivered through an online system, students can take advantage of using their laptops or mobile phones, which offer various features.

The use of mobile phone for facilitating students in the online system has proven its merits. At the college, all student-participants use mobile phones not only to facilitate their communication but also support their daily activities. Previously, [18] claims that mobile phones offer a great possibility for integrating technology into teacher training programs because mobile phone ownership appears to be practically ubiquitous among student-teachers, and the vast majority of them have at least one internet-connected device.

In the present study, all student- participants were in favour of using their mobile phones in many contexts of learning, including when an online platform was being carried out. They claimed that engaging in online learning accelerated technology integration and invited further exploration. In a broader sense, such devices could not be separated from their daily activities. Scheduling, doing

assignments, browsing, updating materials, checking the results of assessments, making presentations, even shopping or trading online were all done through their mobile phones.

Further explored, the analysis showed that their engagement in social media, such as Facebook, Instagram, Twitter, or blogging, enabled them to join many learning communities supporting their abilities and even created some content for YouTube. All student-participants admitted that by using social media, they could extend friendships from other countries to enhance their proficiencies, especially in speaking and writing skills. They collaborated with others of their learning community to create content collaboratively. Similarly, [18] argues that blogging, photo essays, screen casting, producing films or podcasts, sketching, singing, dancing, and many other activities to support individuals' skills can be promoted.

In relation to the Society 5.0 challenges, student-participants committed to adapting to the changes by improving their competencies needed. Such commitment was important as, in the age of technology and the internet, media literacy, technology literacy, and visual literacy are skills that need to be disseminated and used. However, they believed that apart from technology literacy, strong willingness, creativity, and other positive characters should be developed to handle the challenges of the new era as the globe changed, so would the demands of society, which would shift in unanticipated ways. They believed that education in the era of Society 5.0 certainly requires EFL-competent teachers. As a consequence, they encouraged themselves to be adaptable toward the dynamic changes of society.

In a positive manner, the finding indicated that in dealing with social issues, creative competence, critical thinking, flexibility, openness, invention, agility, sensitivity to challenges, literacies, the capacity to work in cross-disciplinary teams, and the capacity to adjust to change can all be used as strengths. In an education setting, learning strategies, digital competence, and professional skills must all be explicitly integrated into twenty-first century learning. Bearing that in mind, EFL classes, in particular, should empower students with strategies and processes that foster creativity, develop critical thinking, improve teamwork skills, strengthen problem-solving abilities, encourage self-direction, and nurture cross-cultural awareness, all of which contribute to their increased competence [19].

## Conclusion

In higher education, online learning has offered a number of advantages and disadvantages. Aside from some obstacles, such as low connectivity, technical problems, time-consuming or limited mastery of the material presented, online learning was seen to be the greatest way to encourage students to continue learning while also adhering to health protocols, especially at the time of crisis. Such platforms promote autonomous learning, make course content more accessible, increase interaction, reduce course desertion, promote dialogue, and enhance problem-solving skills.

In relevance to the high demands of Society 5.0, where individuals need to have data, technology, and human literacy capabilities, the practice of online learning somehow brings strong impacts on students' awareness to keep up integrating technology into their daily lives. Moreover, engaging in online learning encourages them to upgrade transversal competencies as well as develop the 4 Cs (critical thinking, creativity, communication, and collaboration). Overall, the increased use of technology in online learning can be used as a shortcut to address some of the new era's issues.

## References

- [1] C. M. Toquero, "Challenges and Opportunities for Higher Education amid the COVID-19 Pandemic: The Philippine Context," *Pedagog. Res.*, vol. 5, no. 4, p. em0063, 2020.
- [2] P.S. Prabu, "Awareness About E-Learning Among Arts and Science College Students," *Int. J. Innovation. Educ. Res.*, vol. 3, no. 7, pp. 110–114, 2015.
- [3] M. M. Abbad, D. Morris, and C. de Nahlik, "Looking under the Bonnet: Factors affecting student adoption of E-learning system in Jordan," *Int. Rev. Res. Open Distance Learn.*, vol. 10, no. 2, pp. 1–25, 2009.
- [4] V. Arkorful and N. Abaidoo, "The role of e-learning, advantages and disadvantages of its adoption in higher education," *Int. J. Instr. Technol. Distance Learning.*, vol. 12, no. 1, pp. 29–42, 2015.
- [5] D. Shivangi. "Online Learning: A Panacea in the Time of COVID-19 Crisis." *Journal of Educational Technology Systems*.vol. 49, no.1, pp. 5-22. 2020
- [6] M. S Sarvestani, M. Mohammadi, J. Afshin, L. Raeisy, "Experiences of E-Learning Challenges; a Phenomenological

Study". *Interdisciplinary Journal of Virtual Learning in Medical Science*. vol.10, no.3, 2019.

- [7] M F. Beaudoin, G. Kurt, S. Eden. "Experiences and Opinions of E-learners: What Works, What are the Challenges, and What Competencies Ensure Successful Online Learning", *Interdisciplinary Journal of E-Learning and Learning Object.* vol.5, 2009.
- [8] O. S. Aboderin, "The Challenges and Prospects of E-learning in National Open University of Nigeria," *Journal of Education and Learning (EduLearn).*, vol. 9, no. 3, p. 207, 2015.
- [9] S. Appana. "A Review of Benefits and Limitations of Online Learning in the Context of the Student, the Instructor, and the Tenured Faculty." *International Journal on E-learning.* vol. 7. no. 1. Pp. 5-22. 2008
- [10] Y. Zengin, S. Naktiyok, E. Kaygın, O. Kavak, and E. Topçuoğlu, "An investigation upon industry 4.0 and society 5.0 within the context of sustainable development goals," *Sustain.*, vol. 13, no. 5, pp. 1–16, 2021.
- [11] M. Fukuyama, "Society 5.0: Aiming for a New Human-centered Society," *Japan SPOTLIGHT*, no. August, pp. 8–13, 2018.
- [12] T. L. Wentling, C. Waight, J. Gallagher J, J. La Fleur, C. Wang, Kanfer A." E-learning – A review of literature Knowledge and Learning Systems" *Group NCSA.* 9.1–73.2000.
- [13] A. Algahtani, "Evaluating the effectiveness of the E-learning Experience in Some Universities in Saudi Arabia from Male Students ' Perceptions," *Durham Univ. E-Theses Degree Dr. Philos.*, vol. 27, pp. 1–328, 2011.
- [14] A. Perveen, "Synchronous and Asynchronous E-Language Learning: A Case Study of Virtual University of Pakistan." *Open Praxis.*, vol. 8, no.1, pp. 21–39, 2018
- [15] M. L. Cacheiro-Gonzalez, A. Medina-Rivilla, M. C. Dominguez-Garrido, and M. Medina- Dominguez, "The learning platform in distance higher education: Student's perceptions," *Turkish Online J. Distance Educ.*, vol. 20, no. 1, pp. 71–95, 2019
- [16] C. Narvaez Rojas, G. A. Alomia Peñafiel, D. F. Loaiza Buitrago, and C. A. Tavera Romero, "Society 5.0: A Japanese concept for a super intelligent society," *Sustainability.*, vol. 13, no. 12, 2021.
- [17] J. Voogt, N.P. Roblin J., 'A comparative analysis of international frameworks for 21<sup>st</sup> century competences: Implications for national curriculum policies.' *Journal of Curriculum Studies.* vol. 44, no. 3, pp. 299–321.2012

- [18] A. Chimpololo, "An analysis of heutagogical practices through mobile device usage in a teacher training programme in Malawi," *J. Learn. Dev.*, vol. 7, no. 2, pp. 190–203, 2020.
- [19] Y. J. Fandiño, "21st century skills and the English foreign language classroom: A call for more awareness in Colombia," *Gist Education and Learning Research Journal*, vol. 7, no. November, pp. 190–208, 2013.

# **Bumdes Services Can Improve the Community's Economy in Sharia Perspective**

Heru Cahyono<sup>54</sup>, Muh. Fahrurrozi<sup>55</sup>, Nursaid<sup>56</sup>

## **Introduction**

Village-Owned Enterprises or abbreviated as BUMDes are village business institutions that are managed by the community and village government in an effort to strengthen the village economy and are formed based on the needs and potential of the village. The establishment of BUMDes is based on Law no. 32 of 2004 jo. UU no. 23 of 2014 concerning Regional Government, Law no. 6 of 2014 concerning Villages and PP no. 72 of 2005 concerning Villages. Village-Owned Enterprises, hereinafter referred to as BUMDes, are village economic institutions/bodies with legal entities established and owned by the Village Government, managed economically independently and professionally with all or most of the capital being separated village assets. In the end, BUMDes was formed with the aim of gaining profits to strengthen Village Original Income (PADes), promote the village economy, and improve the welfare of rural communities. (Study Program) In the end, BUMDes functions as a driving force for the village economy and the welfare of rural communities. The hope with the existence of BUMDes is the formation of new businesses rooted in existing resources as well as optimizing the economic activities of existing rural communities.[1], [2].

BUMDes is a business entity whose entire or most of the capital is owned by the village through direct capital participation from village assets. This institution is predicted as a force that will be able to encourage the creation of an increase in welfare by creating economic productivity for the village based on the various potentials of the village.[3]

BUMDes must be born at the will of all villagers, which is decided through the Village Deliberation (Musdes). Musdes is the highest forum that gives birth to various main decisions in BUMDes starting from the name of the institution, the selection of management to the type of business to be run, born as a village institution that functions to create community welfare by utilizing the assets and

---

<sup>54</sup> Institut Agama Islam Bunga Bangsa Cirebon

<sup>55</sup> Universitas Hamzanwadi Lombok Timur

<sup>56</sup> Universitas Muhammadiyah Jember

potentials of the village and armed with equity participation from the village. [4]

BUMDes is a business institution that is engaged in the management of village economic assets and resources within the framework of empowering rural communities. The regulation of BUMDes is regulated in Article 213 paragraph (1) of Law no. 32 of 2004, that Villages can establish Village-Owned Enterprises in accordance with the needs and potential of the village. In addition, it is also regulated in Government Regulation Number 72 of 2005 concerning Villages, which regulates BUMDes, namely in Articles 78 – 81, Fifth Part concerning Village-Owned Enterprises, and the last is Minister of Home Affairs Regulation Number 39 of 2010 concerning Business Entities. Village Owned. The purpose of BUMDes is to optimize the management of existing village assets, promote the village economy, and improve the welfare of rural communities. The nature of BUMDes' business is profit-oriented. The nature of business management is openness, honesty, participatory and fair. And the functions of BUMDes are: as a driving force for the village economy, as a business institution that generates Village Original Income (PADes), as well as a means to encourage the acceleration of improving the welfare of rural communities. With the presence of BUMDes, it is hoped that the village will become more independent and the community will become more prosperous There are various problems that have prevented thousands of BUMDes from growing as expected.

First, because the BUMDes discourse for many new villages is still in its infancy, especially since the enactment of the Village Law no. 6 of 2014 concerning Villages. Since then, the government has stepped up the issue of establishing BUMDes in all villages across the archipelago.[5]

The establishment and management of Village Owned Enterprises (BUMDes) is a manifestation of the productive economic management of the village which is carried out in a cooperative, participatory, emancipatory, transparent, accountable and sustainable manner. To achieve the objectives of BUMDes, it is carried out by meeting the needs (productive and consumptive) of the community through the distribution of goods and services managed by the community and the Village Government. Fulfilling this need is sought not to burden the community, considering that BUMDes will be the most dominant village business in driving the village economy. BUMDes are also required to be able to provide services to non-members (outside the village) by placing prices and services that



apply market standards, meaning that there is an institutional mechanism/rules that are mutually agreed upon, so as not to cause businesses to be run by BUMDes. [6]

The involvement of the Village Government as the largest BUMDes capital participant or as a co-founder of the community is expected to be able to meet minimum service standards. This minimal service is realized in the form of protection against harmful interventions from third parties, whether they come from within or from outside. The Village Government also plays a role in the formation of BUMDes as a legal entity that is based on the applicable laws and regulations, and in accordance with the agreements developed in the village community.

BUMDes according to the Elucidation of Article 107 paragraph (1) letter (a) Law Number 22 of 1999 concerning Regional Government is the empowerment of village potentials in increasing village income, among others, by establishing Village-Owned Enterprises, collaborating with third parties, and authority to make loans. Furthermore, BUMDes according to Article 213 paragraph (3) of Law Number 32 of 2004 concerning Regional Government is an economic institution whose business capital is built on the initiative of the community and adheres to the principle of independence. This means that the fulfillment of BUMDes business capital must come from the community and it is possible that BUMDes can apply for capital loans to outside parties, such as from the Village Government or other parties, even through third parties. The provisions of Article 1 paragraph (6) of the Minister of Home Affairs Regulation Number 39 of 2010 concerning Village-Owned Enterprises, states that BUMDes is a village business formed/established by the village government whose capital ownership and management is carried out by the village government and the community. Likewise, BUMDes in Article 78 of Government Regulation Number 72 of 2005 concerning Villages, that in order to increase community and village income, the Village Government establishes a Village-Owned Business Entity (paragraph 1) The establishment of a Village-Owned Business Entity is stipulated in a Village Regulation guided by the laws and regulations. -invitation (paragraph 2). The form of Village-Owned Enterprises must be a legal entity (paragraph 3). The Regional Regulation of Kuningan Regency which regulates BUMDes is Perda Number 19 of 2003 concerning Village-Owned Enterprises. Article 2 of the Regional Regulation concerning Procedures for the Establishment of Village Owned

Enterprises, Article 3 Conditions for Establishing BUMDes and Article 4 concerning Management of BUMDes. [6], [7]

### **Research methods**

The research used is qualitative research, namely research that is descriptive and tends to use analysis. Process and meaning (subject perspective) are more highlighted in qualitative research. The theoretical basis is used as a guide so that the research focus is in accordance with the facts in the field. In addition, this theoretical basis is also useful for providing an overview of the research background and as a material for discussing research results. In qualitative research, the researcher starts from the data, uses existing theories as explanatory material, and ends with a "theory".[8]

Objects in qualitative research are generally limited in number. In this study, the researcher participates in the event/condition being studied. For this reason, the results of this study require a depth of analysis from the researcher. In addition, the results of this study are subjective so they cannot be generalized. In general, qualitative research is conducted using interviews and observation methods. Through this method, researchers will analyze the data obtained from the field in detail. Researchers cannot research the observed social conditions, because the whole reality that occurs is a unity that occurs naturally. The results of qualitative research can also lead to new theories or concepts, if the results of the research contradict the theories and concepts that were previously used as studies in research[9].

### **Results and Discussion**

#### **The role of BUMDes in improving the village community's economy**

BUMDes is a business entity that manages village potential so that it can improve the economy of rural communities, BUMDes in the village have been running for approximately 3 years and already have several types of business units. BUMDes provides an economic role by running several business units and creating jobs to improve the welfare of rural communities. The roles of BUMDes include:

a. Community business development

The role of BUMDes in helping develop village community businesses is in the savings and loan business unit, which is one of the business activity units in BUMDes. This business unit provides opportunities for the community to save or provide loans to the

community. Loans that are channeled to people who want to develop their business

From the results of an interview with one of the capital borrowers named Linda Lisdiyani explained that the results of the capital loan have been able to help develop her business and also increase her income, as explained as follows:

"I have a food processing business since before the existence of BUMDes, and I want to develop my business, and I applied for a loan for my business, and I applied for a loan for my business to BUMDes and after that I also with the capital I got from BUMDes managed to increase The shortcomings for my business are in the form of additional capital and procurement of additional raw materials."

With the savings and loan business at BUMDes, it has helped the community to develop their business, and the community does not need to borrow from the bank with a long and complicated process, and avoids people borrowing money from moneylenders who have now entered the Village Area and whose existence is quite disturbing to the community. because people who borrow money from the bank daily the interest expense that must be paid is quite high. In addition, in the letter Al-Maidah verse 2 which means:

"...and please help you in (doing) righteousness and piety, and do not help in committing sins and transgressions, and fear Allah, verily Allah is severe in punishment." (Surat al-Maidah: 2). The verse above explains that BUMDes is a business entity that provides assistance to people who need it.

b. Open Jobs

BUMDes also plays a role in opening up employment opportunities, especially in terms of managing the Talaga Biru Cicerem tourism object, all of its employees are village communities with almost 70 people every day, so BUMDes has helped reduce unemployment in the village by providing employment opportunities, as explained by one employee. in BUMDes and is the deputy chairman of the Village Youth Organization:

"I am a village community and I happen to be active in Karang Taruna and serve as vice chairman of the Janggala Manik Youth Organization, I have worked with BUMDes for almost 1 year and I feel helped by BUMDes, because I can work and I don't have to go to the city. to find work and leave my family here".

c. Increasing Village Original Income

In addition to the community, BUMDes plays a role in increasing Village PAD. The percentage of BUMDes profit sharing based on AD/ART is 30% for villages, 30% for capital reserves, 10% for education funds, 10% for social funds, 5% for advisory services, 5% for supervisory services, 10% for managers, and 10% for community empowerment. Profit sharing can still be increased if all business units can generate profits.

**Village Owned Enterprises (BUMDES) services in improving the village community's economy**

Village-Owned Enterprises (BUMDes) can use Sharia-compliant transactions in running their business. This is because in rural areas the values of mutual cooperation are still strong. This value indicates that the village community is very concerned with the conditions that occur in other people so that they will not do something that is detrimental to only one party.

Islam teaches that in the economic system of its people, it is based on the values of justice that must be upheld, and is the main principle for carrying out economic activities. Every economic activity must contain an element of benefit and not mistreat himself and others, so that economic activity can create an equitable community welfare. Likewise, what is done by BUMDes in terms of services in each business unit that is carried out is not allowed by committing fraud, coercion or taking other people's property. In providing BUMDes tourism services, especially the Tourism Division, the services are adjusted to sharia principles by having a tourist guide that can prevent the occurrence of shirk, superstition, immorality, adultery, pornography, porno-action, liquor, drugs and gambling.

Tour guides in welcoming tourists who come to Talaga Biru Cicerem they give greetings, greetings are friendly, polite and courteous. Their appearance was hooded and accentuated the Islamic concept.

In several places in the village area, trash cans have been provided, this is in accordance with the sharia concept that "Cleanliness is part of faith", to maintain sustainability, beauty and cleanliness in tourist attractions. Provision of a place of worship in the form of a prayer room complete with facilities with the concept of separation between men and women, as well as notification of the time before prayer (Adhaan).

Everything that BUMDes does in its services, in addition to adding to the comfort of tourists themselves, but also making them enjoy comfort by sticking to sharia principles.

### **Things that become obstacles in the management of BUMDes**

The indicator of the success of BUMDes in developing the community's economy is the participation of the community itself. Therefore, community participation through BUMDes includes: a) Planning. Community participation in planning starts from the stage of community participation in forming BUMDes as an autonomous village body that has the authority to mobilize community business activities. The next community participation in planning is the presence of the community in the socialization and planning of BUMDes activities. b) Implementation. Community participation in implementation is carried out after planning, a form of community participation in the management of business units carried out by BUMDes, such as the community participating in maintaining the cleanliness of the village tourism environment managed by the BUMDes tourism unit. c) Monitoring and Evaluation. Monitoring and evaluation are needed in BUMDES activities so that all business units formed by BUMDES can run according to what has been planned, supervision is the duty and obligation of BUMDES administrators, village governments, and the community. The role of the community in monitoring and evaluation activities is very important. At this stage, the community is involved in overseeing the operation of every business unit carried out by BUMDES so that it is in accordance with the needs of the community, "The Concept of Assets and Management in the Qur'an"

The design of Sharia BUMDES begins by analyzing internally the strengths and weaknesses of BUMDES as well as externally the opportunities and challenges (threats) that will be faced by BUMDES if it applies Islamic values in its operational activities. This step is commonly referred to as a SWOT (Strengths, Weaknesses, Opportunities, and Treats) analysis. The following is a SWOT analysis in designing the Sharia BUMDES business model:

#### **Strength**

- 1) The strength of working capital of sufficient size and certainty of its source, namely from the village government's capital participation.

- 2) The obedience of the villagers in carrying out religious values is still maintained to this day
- 3) The majority of the Indonesian population and more specifically in the villages are adherents of the Islamic religion
- 4) The diversity of village natural resources is a potential for BUMDES product development
- 5) Great motivation and enthusiasm from BUMDES managers to develop BUMDES

### **Weakness**

- 1) Very limited understanding of Muamalah Fiqh. Most of the Muslim community, including in villages, only focus on strengthening aqidah, morals, and fiqh of worship. Not many preachers have used the pulpits to campaign for the Islamic economic system
- 2) The ability of entrepreneurs is still very limited so that some BUMDES managers are still confused about what business model they will develop
- 3) The managerial and accounting capabilities of each BUMDES manager are minimal, so it is difficult to maximize the profitability of BUMDES
- 4) The infrastructure facilities in the village are still very limited, especially in developing technology-based BUMDES.

BUMDES carries out two roles, namely as a business entity as well as a social entity. These two roles are not mutually exclusive as some business people think that social goals and business goals are two different things and cannot be presented simultaneously in one entity. This view is based on the assumption that the company's social activities will cause costs that do not have an impact on revenue and ultimately prevent the company from obtaining optimum profit. BUMDES Syariah is here to provide a rebuttal to this view. The author's view, social goals and business goals are two things that are interconnected in the development of BUMDES. Even the sustainability of BUMDES in the future is determined to what extent Sharia BUMDES is able to provide benefits to the community in the village. Therefore, the product innovation offered by BUMDES Syariah does not only emphasize profit-oriented products but also benefit-oriented products. as contained in the letter An-Nahl verse 71:

وَاللَّهُ فَضَّلَ بَعْضَكُمْ عَلَى بَعْضٍ فِي الرِّزْقِ ۗ فَمَا الَّذِينَ فُضِّلُوا بِرَأْدِ رِزْقِهِمْ عَلَىٰ مَا مَلَكَتْ أَيْمَانُهُمْ فَهُمْ

فِيهِ سَوَاءٌ أَفْبِنِعْمَةِ اللَّهِ يَجْحَدُونَ

*It means:*

*"And Allah has favored some of you over others in terms of sustenance, but those who are extra (their sustenance) do not want to give their sustenance to the slaves they have, so that they will be the same (feel) the sustenance. So why do they deny the favor of Allah?"*

The above verse states that human ownership is not absolute ownership, but relative ownership. In the Islamic economic system, we can capture the instrumental values that must be enforced and implemented and are very influential on the economic behavior of humans and society as well as economic development in general.

Islam is very encouraging with cooperation, including in the economic field, especially the Tourism Unit which is run by BUMDes. This can be seen from the many verses of the Qur'an that command and encourage mankind to help each other in goodness and piety and not to help each other in matters of sin and enmity. In this case, BUMDES is in accordance with Islamic economics regarding Economic Cooperation. BUMDES provides equal opportunities for people who want to participate in managing tourism.

Economic transactions carried out by BUMDes n are in accordance with sharia aspects including the Profit Sharing Principle which has been running for 3 years by involving third parties in terms of procuring spot photo rides at tourist attractions. This activity involves two or more people and there is a clear bond in the form of (a contract) between them. The contract itself is an agreement, engagement or agreement between the parties who make an agreement on a certain object and in shigoh (lafadz) right in the ijab-qobul. The contract/agreement regulates the binding relationship between the parties regarding rights and obligations. There are several types of contracts in Islamic economics, namely:

1. Al-wadi'ah can be interpreted as a pure deposit from one party to another, both individuals and legal entities, which must be guarded and returned whenever the custodian wishes. The recipient of the deposit is yad al-amanah (hand of trust), meaning that he is not responsible for any damage or loss that occurs to the deposited asset. Therefore, the concept of al-wadi'ah yad al-amanah is that the party receiving it may not use and utilize something that is entrusted. However, you must really keep it as usual. The recipient of the deposit may charge a fee to the depositor as a deposit fee.

2. Al-musarakah is a contract of cooperation between two or more parties in a particular business in which each party contributes funds (charity / expertise) with the agreement that the profits and risks will be shared in accordance with the agreement. Almudharabah is a contract made between the owner of the capital (shâhib almâl) and the manager (mudharib) so as to obtain profit or income from the management. The income or profit is divided based on the nishbah (share) that has been agreed at the beginning of the contract. However, if a loss occurs, the owner of the capital is the party who bears the responsibility, as long as it is not due to the negligence of the manager. If the loss is caused by the manager, the party must be responsible for the loss. Almuzzara'ah is an agricultural processing cooperation agreement between the land owner and the cultivator, in which the land owner gives agricultural land to the cultivator to be planted and maintained in exchange for a certain share (percentage) of the harvest. Al-musaqah is a simpler form of muzara'ah in which the cultivator is only responsible for watering and maintenance. In return, the cultivator is entitled to a certain ratio of the harvest.
3. Bai' Al-murabahah is a contract made in the context of financing by the owner of capital (shâib al-mâl) in the form of a bailout to a customer to purchase goods/services with the obligation to return the bailout in full plus a profit margin between the difference between the purchase price from the supplier and the selling price to customers. In bai' Al-murabahah, the seller tells the price of the product purchased. Bai' 'Al-murabahah can also be made for purchases by order. Bai' as-salam is a financing contract in the form of a bailout of funds needed by the customer to purchase an item/service with an advance payment before the goods/services are delivered or formed. Users of goods/services (customers) are obliged and return the bailout funds plus the bank's profit margin on credit within a certain period of time or in cash according to the agreement. Bai Al-istishna contract is a contract of sale between the buyer and the manufacturer of the goods. In this contract, the manufacturer of the goods receives an order from the buyer. The manufacturer of the goods then seeks through others to manufacture or purchase goods according to agreed specifications and sell them to the final owner. Both parties agree on the price and payment system.
4. Ijârah or leasing is a financing contract in the form of a bailout from the shâhib al-mâl which is required by the customer to own



an item or service with the obligation to rent the item within a certain period of time in accordance with the agreement. It is easy, namely the usufructuary rights for goods and services, through the payment of wages and rent, without being followed by the transfer of ownership of the goods themselves.

5. Wakâlah is a contract that is carried out by giving power to a party who has the ability (shâhib al-mâl) to take action or actions on behalf of the customer in conducting transactions with third parties. Al-kafalah is a guarantee used by the insurer (kafil) to a third party to fulfill the obligations of the second or borne party. In another sense, kafalah means transferring the responsibility of someone who is guaranteed by holding on to the responsibility of another person as a guarantor. Al-hawalah is the transfer of debt from the person who owes it to another person who is obliged to bear it. In simple terms, it can be explained that A (muhal) gave a loan to B (muhil), while B had receivables from C (muhal'alaih). Once B is unable to pay his debt to A, he then transfers the burden of the debt to C. Thus, C must pay B's debt to A, while C's previous debt to B is considered completed. Arrahn is to hold one of the borrower's property as collateral he received. The seized goods have economic value. Therefore, the holding party obtains a guarantee to be able to take back all or part of the receivables. In simple terms it can be explained that rahn is a kind of guarantee of debt or pawn. Al-qardh is a financing contract in the form of loans or assistance to the poor and have the skills or a strong desire to start a small business. The customer in this case is only required to return the principal loan within a certain time (ROLE OF BUMDes).

In its work, BUMDes has a myriad of problems. BUMDes management can be said to be difficult because of problems such as limited Human Resources (HR). In the BUMDes management process, several challenges are often encountered that must be resolved by the BUMDes managers or administrators. Some of the challenges faced in the management of BUMDes are as follows:

1. Organizational setting issues. Organizational arrangements are needed for the smooth running of a business. Good organizational management will encourage business progress and development. Not a few BUMDes are ultimately unable to develop due to the lack of good organizational arrangements in BUMDes. Although the BUMDes management has been established, in its implementation, the BUMDes management has not been able to carry out their responsibilities properly.

2. Finding and developing village potential. The village is a territorial unit inhabited by a number of families that have their own government system headed by a village head. Each village has potential that can be developed, whether it is potential in the field of natural resources (natural tourism, agriculture, etc.) or potential in the field of human resources (crafts, services, etc.). The challenge to develop the potential possessed by the village can be said to be difficult, because uniting the community to develop the village is not easy. Many of them do not want to develop the potential of the village for various reasons. It is necessary to conduct socialization and training of human resources to change the way people think so that they are willing to be invited to manage the potential of the village together.
3. Promotion issues. BUMDes that are well managed and have quality outputs are often still having difficulties in terms of promotion. This of course makes BUMDes management really able to see opportunities and smart in finding ways to do promotions. Because it will be useless if the village's potential has been transformed into a product but cannot be distributed properly just because of poor promotion problems.

### **Solutions taken by BUMDes in Overcoming Problems or Obstacles in Efforts to Improve Community Economy**

According to the results of the research obtained, in solving the obstacles that become obstacles in improving the economy of the BUMDes community, BUMDes has developed a strategy to overcome these obstacles.

1. With the obstacles that occur, BUMDes has a solution to overcome the problem of organizational arrangements that are needed for the smooth running of a business. Good organizational management will encourage business progress and development in terms of organizational regulation. Because BUMDes is an organization for social interests and also for business (business) interests, it needs the right combination as follows: a) Advisor / Commissioner / Board of Commissioners. b) Director/Chairman. c) Secretary, d) Treasurer, e) Business Unit is included in the Business Unit, so that the business unit has directors and managers who drive the business in accordance with the job description.
2. To overcome obstacles in developing the potential possessed by the village, Village development so that it is potential and successful to become an independent and prosperous village is

indeed not easy, many factors will influence the effort through developing the potential that exists in the village. Currently, the village potential that is the focus of attention of the village government and district government is regional development efforts in the form of tourist villages. The world that is affected by globalization has given rise to many new opportunities. Tourism is one of them. Domestic and foreign tourists both want to explore as many new tourist attractions as possible. Not only for tourists, this new opportunity is also the target of many investors who get a new strategic market. Unfortunately, there are not a few areas in the village that are still half-baked in managing their tourist attractions because the area is a tourist area so the village cannot be arbitrary as the village manages it.

3. In overcoming the problem of promotion, the following are some effective steps to promote tourist attractions carried out by BUMDes:
  - a. Cooperation with Related Companies/Agencies. Holding promotional activities with PLN, which has provided CSR funds to villages and is managed for free by the village government, for the development of Talag Biru cicerem. With a business approach, PLN can contribute to sustainable development by providing economic, social and environmental benefits for all stakeholders.
  - b. Marketing through social media, one of which is done by visitors themselves who come to Telaga Biru Cicerem by uploading their videos or photos via social networks Facebook, Instagram or others, indirectly helps a lot in marketing Talaga Biru Cicerem tourism objects, with uploads that have a beautiful background. and the coolness of Talaga Biru makes other people who see it feel curious to come and take spot photos. Apart from marketing content, these modern marketing techniques are also used to market brands. The purpose of marketing the brand here is to introduce another advantage of the village in the form of typical food from the village that will be brought home for souvenirs. With the increase in internet users from previous years, of course it will be an indicator for business people to take a digital approach to their business, products and services.
  - c. Advertising services in various media such as radio, television, tabloids, magazines or newspapers. This step has been taken by Village BUMDes so far. Although not directly the BUMDes to

advertise, but the media themselves are interested in exposing the beauty of the Talaga Biru tourist vehicle to be published on the editorial page of the newspaper.

## Conclusion

The results obtained from BUMDes services can improve the community's economy in the perspective of Sharia in the village, the researchers draw the following conclusions: This BUMDes has helped the community to develop their business, and the community does not need to borrow from the bank with a long and complicated process, and avoids the public borrow money from moneylenders who have now entered the Village Area and whose existence is quite disturbing to the community. The existence of BUMDes in the village has been able to play a role and contribute to the community, even though BUMDes has only been operating for three years and only has a few business units, the role of BUMDes has provided an increase in economic income for the village community, by selling or providing places around tourist sites other than it can reduce the urbanization of young people who are in the Karang Taruna organization to find work in the city. BUMDes has helped reduce unemployment in the village by providing jobs.

## References

- [1] R. Firdaus, "Peran Badan Usaha Milik Desa (BUMDES) Dalam Pemberdayaan Ekonomi Masyarakat Desa Manding Laok Kec. Manding Kab. Sumenep," *J. Inov. Penelit.*, vol. 1, no. 7, pp. 1387–1394, 2020.
- [2] H. Hailudin, "Peranan Badan Usaha Milik Desa (BUMDES) Dalam Pemberdayaan Ekonomi Masyarakat Desa Labuhan Haji Lombok Timur," *Elastisitas - J. Ekon. Pembang.*, vol. 3, no. 1, pp. 1–9, 2021, doi: 10.29303/e-jep.v3i1.32.
- [3] N. Kadek, D. Candra, N. K. Sinarwati, and M. Arie, "Efektivitas pengelolaan dana pada badan usaha milik desa kerta danu mandara di desa songan a," *e-Journal S1 Ak Univ. Pendidik. Ganessa*, vol. 8, no. 2, pp. 1–10, 2017.
- [4] K. Fitriksa, "Strategi Pengembangan Badan Usaha Milik Desa Dalam Meningkatkan Kesejahteraan Masyarakat di Desa Lancang Kuning Kecamatan Bintang Utara," *J. Ilmu Adm. Negara*, vol. 5, no. 2, pp. 29–34, 2017.
- [5] F. Enggraini, N. C. Putri, Y. A. Salman, and W. Handayani, "Peran Kelembagaan Pemerintah Desa dalam Memajukan Desa

- Ponggok-Polanharjo, Klaten," *Matra Pembaruan*, vol. 4, no. 2, pp. 71–82, 2020, doi: 10.21787/mp.4.2.2020.71-82.
- [6] Bambang, "Implemetasi Badan Usaha Milik Desa Berbasis Ekonomi Islam : Suatu Kajian Elementer," *J. Iqtisaduna*, vol. 3, no. 2, 2017.
- [7] D. N. Rahmatika, S. Subroto, D. Indriasih, and D. Prihadi, "Strategi Pengembangan Kualitas Bumdes; Pendekatan Model Tetrapreneur Serta Kemitraan Dengan Perguruan Tinggi Dan Perbankan," *J. Ind. Kreat. dan Kewirausahaan*, vol. 2, no. 2, pp. 84–95, 2021, doi: 10.36441/kewirausahaan.v2i2.58.
- [8] Sugiyono, "Metode Penelitian Kuantitatif, Kualitatif dan R&D," in *Metode Penelitian Kuantitatif, Kualitatif dan R&D*, 26th ed., Bandung: Alfabeta, 2017, p. 5.
- [9] Sugiono, *Metode Penelitian Pendidikan*, 1st ed. Bandung: Alfabeta, cv, 2012.

# **Students' Critical Thinking in Solving Hots Problems: A Case Study in Gender Perspective**

Ida Riskiana Dewi, Umy Zahroh

## **Introduction**

Critical thinking is a very important thinking ability in solving mathematical problems. Critical thinking skills are needed to analyze, identify, evaluate and make decisions for drawing conclusions. Critical thinking skills are needed in solving math problems in the High Order Thinking Skill (HOTS), because HOTS math problems require more ability to translate them into mathematical form [1]. The thinking ability of each individual is certainly different, so there must be special attention to lead students to achieve success in taking education.

Teaching and learning activities are carried out to achieve certain goals that have been formulated before teaching is carried out. Teaching and learning activities are a condition that is deliberately created, the teacher creates it in order to teach students. Teachers who provide knowledge and students who receive knowledge. The combination of these two main elements creates educational interactions by utilizing learning materials as the medium. There all teaching components are played optimally in order to achieve the teaching objectives that have been set before teaching is carried out [2].

The teacher consciously plans his teaching activities systematically by utilizing all the needs for the benefit of learning activities. The hope that never disappears and the teacher always demands is how the lesson material delivered by the teacher can be understood by the students completely, this is a fairly difficult problem that is felt by the teacher. The difficulty is because students are not only individuals with all their uniqueness, but they are also social beings who have different backgrounds. One of the differences created by students in learning is the ability to think between boys and girls (gender).

According to one mathematics teacher at MTsN 2 Tulungagung, "from experience during teaching between male and female students there is always a difference, on average female students tend to be smarter than male students, although there are also a small proportion of male students. who have an intelligence level above female students. Although students' thinking abilities are different, they still have the same goal. The purpose of learning

mathematics in general is to prepare students to be able to face changes in life and an ever-evolving world, on the condition that the changes are made through practice acting on the basis of logical, rational and critical thinking [3].

Psychologists and educationalists recognize that students in schools not only passively remember new information, but that they need to do more and learn how to think critically. Therefore, education in schools must be able to build students' critical thinking awareness [4].

Mathematics learning material of course there are various forms ranging from addition, subtraction, division, multiplication and other forms. In one process of learning mathematics, of course, students are familiar with numbers and even then it is considered a normal thing in learning mathematics, but in learning mathematics it is not only about learning about all numbers but also in the form of words or type questions HOTS. HOTS questions are questions that present learning evaluations that measure the success of the implementation of learning in creating students with high-level thinking skills [5]. In solving the HOTS questions, it requires the ability to analyze, evaluate, and create what is presented in the problem so that a solution can then be found from the answer. In understanding HOTS type questions, students often find it difficult to solve them, therefore critical thinking is needed to be able to solve HOTS type problems.

According to Ennis, critical thinking is reasoned and reflective thinking with an emphasis on making decisions about what to believe or do. While the critical thinking indicators are (1) Elementary clarification, (2) Advance clarification, (3) Strategies and tactics, (4) Inference [6]. The sub-indicators of critical thinking used are analyzing questions, identifying assumptions, determining solutions, writing answers, determining conclusions, and determining other alternatives.

Based on the description, students still have difficulty in solving HOTS type questions related to the Pythagorean Theorem and also there are differences in thinking between male and female students. This makes it necessary to conduct research on the critical abilities of class VIII MTsN 2 Tulungagung students in solving HOTS questions on the Pythagorean Theorem material in terms of gender.

## **Discussion**

The results of research on students' critical thinking in solving HOTS problems on the Pythagorean Theorem material based on gender.

### **Critical Thinking Ability of Female Students in Solving HOTS Problems**

#### **1. Elementary clarification**

Ability to analyze questions, S1 students in working on questions number 1 and 2 are able to analyze questions with students being able to explain the meaning of the HOTS questions asked. Masters students in working on questions number 1 and 2 are able to analyze the questions with students being able to explain the meaning of the HOTS questions asked. Doctoral students in working on questions number 1 and 2 are able to analyze questions with students being able to explain the meaning of the HOTS questions asked. From the three female students studied, it can be concluded that female students are able to meet the indicators of ability to analyze questions well.

#### **2. Advance clarification**

Ability to identify assumptions, S1 students in working on questions number 1 and 2 are able to analyze questions with students being able to identify assumptions with students being able to explain what is known from the HOTS questions asked. Masters students in working on questions number 1 and 2 are able to analyze questions with students able to identify assumptions with students being able to explain what is known from the HOTS questions asked. Doctoral students in working on questions number 1 and 2 are able to analyze questions with students being able to identify assumptions with students being able to explain what is known from the HOTS questions asked. From the three female students studied, it can be concluded that female students are able to meet the indicators of ability to identify assumptions well.

#### **3. Strategies and tactics**

Ability to Determine Solutions, S1 students in working on questions number 1 and 2 are able to determine solutions to problems in HOTS questions with students being able to determine the formula used in the HOTS questions asked. Masters students in working on questions number 1 and 2 are able to determine solutions to problems in the HOTS questions with



students being able to determine the formula used in the HOTS questions asked. Doctoral students in working on questions number 1 and 2 are able to determine solutions to problems in HOTS questions with students being able to determine the formula used in the HOTS questions asked. From the three female students studied, it can be concluded that female students are able to meet the indicators of the ability to determine solutions to the HOTS questions correctly.

Ability to write answers, S1 students in working on questions number 1 and 2 are able to write answers in HOTS questions with students being able to calculate the formula correctly in the HOTS questions asked. Masters students in working on questions number 1 and 2 are able to write answers in the HOTS questions with students being able to calculate the formula correctly in the HOTS questions asked. Doctoral students in working on questions number 1 and 2 are able to write answers in HOTS questions with students being able to calculate the formula correctly in the HOTS questions asked. From the three female students studied, it can be concluded that female students are able to meet the indicators of the ability to determine solutions to HOTS questions correctly.

#### **4. Inference**

The ability to determine conclusions, S1 students in working on questions number 1 and 2 are able to write conclusions in HOTS questions with students being able to determine conclusions in the HOTS questions asked. S2 students in working on questions number 1 and 2 were unable to determine conclusions in the HOTS questions with students unable to determine conclusions in the HOTS questions asked. Doctoral students in working on questions number 1 and 2 are able to write conclusions on the HOTS questions with students being able to determine conclusions in the HOTS questions asked. From the three female students studied, it can be concluded that female students are able to meet the indicators of Ability to determine conclusions from solutions to HOTS questions correctly.

The ability to determine other alternative ways of solving problems, the three female students studied in working on questions number 1 and 2 were not able to determine alternative ways to solve the problem in question. Based on the research results, the critical thinking skills of undergraduate students in

solving HOTS questions meet 4 indicators, namely: (1) Elementary clarification, (2) Advance clarification, (3) Strategies and tactics, (4) Inference. Masters students in solving HOTS questions meet 3 indicators, namely: (1) Elementary clarification, (2) Advance clarification, (3) Strategies and tactics. Doctoral students in solving HOTS questions meet 4 indicators, namely: (1) Elementary clarification, (2) Advance clarification, (3) Strategies and tactics, (4) Inference.

From the description above, it can be concluded that female students in solving HOTS questions on the Pythagorean theorem are able to understand problems, are able to solve problems, are able to conclude and are able to determine conclusions from problem solving. This is in accordance with the opinion of Loviga Denny Pratama and Wahyu Lestari, namely based on the results of analysis and discussion, critical thinking skills of students who have been able to meet the indicators at the classification stage, assessment stage, inference stage, and strategy stage in solving performance task questions are included as a group. above with a value between 66.67%-100% [7]. In line with Budi Cahyono's opinion, female students are able to give simple explanations, make further explanations, strategies and tactics and conclude [8]. In accordance with Safruddin Kaliky's opinion, namely in the completion process based on the stages, it appears that female students tend to be thorough and systematic [9].

## **Critical Thinking Ability of Male Students in Solving HOTS Problems**

### **1. Elementary clarification**

Ability to analyze questions, S4 students in working on questions number 1 and 2 are able to analyze questions with students being able to explain the meaning of the HOTS questions asked. S5 students in working on questions number 1 and 2 are able to analyze the questions with students being able to explain the meaning of the HOTS questions asked. S6 students in working on questions number 1 and 2 are able to analyze questions with students being able to explain the meaning of the HOTS questions asked. From the three male students studied, it can be concluded that male students are able to meet the indicators of ability to analyze questions well.

### **2. Advance clarification**

Ability to identify assumptions, S4 students in working on

questions number 1 and 2 are able to analyze questions with students being able to identify assumptions with students being able to explain what is known from the HOTS questions asked. S5 students in working on questions number 1 and 2 are able to analyze questions with students being able to identify assumptions with students being able to explain what is known from the HOTS questions asked. S6 students in working on questions number 1 and 2 are able to analyze questions with students being able to identify assumptions with students being able to explain what is known from the HOTS questions asked. From the three male students studied, it can be concluded that male students are able to meet the indicators of the ability to identify assumptions well.

### **3. Strategies and tactics**

Ability to Determine Solutions, S4 students in working on problem number 1 are able to determine solutions to problems from HOTS questions while question number 2 is unable to determine solutions to problems in HOTS questions. S5 students in working on questions number 1 and 2 are not able to determine solutions to problems in questions HOTS with students unable to determine the formula used in the HOTS questions asked. RJRA students in working on questions number 1 and 2 were not able to determine the solution to the problem in the HOTS questions with students unable to determine the formula used in the HOTS questions asked. From the three male students studied, it can be concluded that only 1 male student is able to meet the indicators of the ability to determine the solution of the HOTS questions correctly.

Ability to write answers, S4 students in working on questions number 1 and 2 are not able to write answers in HOTS questions with students not being able to calculate the formula correctly in the HOTS questions asked. S5 students in working on questions number 1 and 2 are not able to write answers in the HOTS questions with students not being able to calculate the formula correctly in the HOTS questions asked. S6 students in working on questions number 1 and 2 are not able to write answers in the HOTS questions with students not being able to calculate the formula correctly in the HOTS questions asked. From the three male students studied, it can be concluded that the male students are not able to meet the indicators of the ability to determine the solution of the HOTS questions correctly.

### **4. Inference**

The ability to determine conclusions, S4 students in working

on questions number 1 and 2 are not able to write conclusions in the HOTS questions with students unable to determine conclusions in the HOTS questions asked. S5 students in working on questions number 1 and 2 were unable to determine conclusions in the HOTS questions with students unable to determine conclusions in the HOTS questions asked. S6 students in working on questions number 1 and 2 are not able to write conclusions in the HOTS questions with students not being able to determine conclusions in the HOTS questions asked. From the three male students studied, it can be concluded that male students are not able to meet the indicators of Ability to determine conclusions from the solution of the HOTS questions correctly.

The ability to determine alternative ways of solving the problem in question, the three male students who were studied in working on questions number 1 and 2 were not able to determine alternative ways of solving the problem in question. Based on the results of the research, the critical thinking skills of S4 students in solving HOTS questions meet 3 indicators, namely: (1) Elementary clarification, (2) Advance clarification, (3) Strategies and tactics. S5 students in solving HOTS questions meet 2 indicators, namely: (1) Elementary clarification, and (2) Advance clarification. S6 students in solving HOTS questions meet 2 indicators, namely: (1) Elementary clarification, and (2) Advance clarification.

From the explanation above, it can be concluded that male students in solving HOTS questions on the Pythagorean Theorem material, are only able to understand the problem, do not reach the stage of problem solving and determine other alternatives in solving problems. This is in line with Budi Cahyono's opinion, namely the subject is able to identify the facts given in the matter clearly, logically, concisely, effectively and efficiently, only identifying problems based on elements that are only related to the problem. So as to be able to identify problems and understand the questions in the questions, this can be seen from the ability to write down the elements that are known from the questions and those asked in the questions [8]. And in line with the opinion of Herlina Fahrunisak who said the ability to think critically with problems was not able to determine the solution to the problem in question, was unable to write down the answer to the problem in the problem correctly, the conclusions given were wrong, and were unable to determine other alternative ways, belonging to the ability level. moderate critical thinking [10].

The conclusion from the description is that male and female students have different abilities in critical thinking to solve HOTS questions on the Pythagorean Theorem material. Female students tend to be thorough, careful and precise in understanding math problems, while boys tend to reason as they are without paying attention to accuracy, precision and accuracy in understanding math problems. This is supported by Nafián that the difference between men and women in learning mathematics is that men are superior in reasoning, while women are superior in accuracy, thoroughness, accuracy, and thoroughness in learning [11].

## **Conclusion**

Based on the results of research on students' critical thinking skills in solving HOTS questions on the Pythagorean theorem material in terms of gender, it can be concluded that: first, the critical thinking skills of female students in solving HOTS questions on the Pythagorean theorem material, namely female students are able to meet 4 critical thinking indicators, namely (1 ) Elementary clarification, (2) Advance clarification, (3) Strategies and tactics, (4) Inference. Because female students in solving problems in the form of HOTS questions are able to understand the meaning of the questions and are able to solve problems properly and correctly. Second, the critical thinking ability of male students in solving HOTS questions on the Pythagorean theorem material, namely male students are able to meet 2 indicators, namely (1) Elementary clarification, and (2) Advance clarification. Because male students in solving problems in the form of HOTS questions, are only able to understand and know the meaning of the questions.

The results of this study can be used as reference material for teachers to help students in the habit of critical thinking in every teaching and learning activity that takes place, especially in solving mathematical problems. This can be done by frequently giving problems related to ongoing mathematical material in the form of story questions or those related to everyday life. So that students will gradually get used to math problems in the form of HOTS questions.

## **References**

- [1] H. N. Dinni, "HOTS ( High Order Thinking Skills ) dan Kaitannya dengan Kemampuan Literasi Matematika," *Prisma*, vol. 1, pp. 170–176, 2018.
- [2] S. B. Djamarah and A. Zain, *Strategi Belajar Mengajar*, (Jakarta:

- Jakarta: Rineka Cipta, 2010.
- [3] M. Masykur and A. H. Fathani, *Mathematical Intellegence Cara Cerdas Melatih Otak dan Menanggulangi Kesulitan Belajar*. Jogjakarta: Ar-Ruzz Media, 2008.
  - [4] Desmita, *Psikologi Perkembangan*. Bandung: Rosda Karya, 2012.
  - [5] A. Budiman and J. Jailani, "Pengembangan Instrumen Asesmen Higher Order Thinking Skill (HOTS) Pada Mata Pelajaran Matematika Smp Kelas Viii Semester 1," *J. Ris. Pendidik. Mat.*, vol. 1, no. 2, p. 139, 2014, doi: 10.21831/jrpm.v1i2.2671.
  - [6] R. . Ennis, "The Nature Of Critical Thinking:outlines Of General Critical Thinking Dispositions and Abilities, Last Revised September,," 2015.
  - [7] L. D. Pratama and W. Lestari, "Kemampuan Berpikir Kritis Siswa dalam Menyelesaikan Soal Performance Task, ( Universitas Negeri Yogyakarta, Seminar Matematika dan Pendidikan Matematika UNY)," 2017.
  - [8] B. Cahyono, "Analisis Ketrampilan Berfikir Kritis dalam Memecahkan Masalah Ditinjau Perbedaan Gender," *Aksioma*, vol. 8, no. 1, p. 60, 2017.
  - [9] S. Kaliky and F. Juhaivah, "Syafuruddin Kaliky dan Fahruh Juhaevah, Analisis Kemampuan Berfikir Kritis kelas X SMA dalam menyelesaikan masalah trigonometri," *Mat. dan pembelajaran*, vol. 6, no. 2, 2018.
  - [10] H. Fahrunisak, "Analisis Kemampuan Berpikir Kritis Siswa Kelas Vii Dalam Menyelesaikan Soal Matematika Materi Garis Dan Sudut Di MTsN Tunggangri Tulungagung,," 2014.
  - [11] M. I. Nafi'an, "Kemampuan Siswa dalam Menyelesaikan Soal Cerita Ditinjau dari Gender di Sekolah Dasar,," 2011.

# Strengthening Pedagogical Competence of 21<sup>st</sup> Century Teachers

Ifit Novita Sari<sup>57</sup>

## Introduction

The profession of teacher is a profession that looks easy by some people. The teacher delivering the material by the lecture method has been considered capable of becoming a teacher. Teachers have a strategic role and become one of the determining factors of educational success in a country. Teachers as pillars of education, teachers must continue to improve their competence in line with the latest scientific and technological developments. Teachers have a responsibility to their students and the state. Teachers play a major role in the framework of succeeding national education goals. Teachers have many roles attached to their profession, including educators, teachers, learning resources, facilitators, mentors, demonstrators, managers, advisors, innovators, motivators, coaches, and evaluators[1].

Teachers must pursue the path of higher education and professional education of teachers (PPG) to meet standards and quality by the Law. The main task of teachers as educators is to direct learners in developing their potential for the better. The characteristics of very diverse learners become the biggest challenge of teachers in carrying out their duties and carrying out the great ideals of the nation in educating the life of the nation. Teachers as educators, role models, and role models for learners and their environment. Teachers must be skilled in solving various problems experienced by learners and themselves at the time of learning in their classrooms.

The final cycle at each end of learning is an evaluation. Teachers conduct learning evaluations to learners in the form of written exams, performances, and attitude assessments. The results of the evaluation will show the ability of learning goals carried out by teachers. Teachers can measure the learning that is carried out successfully or not seen from the results of the evaluation of learners. The results of the evaluation can be measured the extent to which the teacher mastered the competencies that must be possessed[2].

---

<sup>57</sup> Universitas Islam Malang

Law No. 14 of 2005 concerning Teachers and Lecturers mentions that teacher competence includes pedagogical competence, personality competence, social competence, and professional competence obtained through professional education[3]. These four competencies become a unit that cannot be separated. Mastery of these competencies must be owned by teachers by the mandate of the Law and obtained through PPG. Teachers must master these competencies to support their process to teach well and achieve the learning goals that have been designed. The issue of four teacher competencies is currently still a hot conversation among educators. Direct interaction between teachers and learners in learning activities still experiences many obstacles.

The Covid-19 pandemic changed the fabric of human life in every way. The education sector is one of the sectors affected. When a pandemic hit most parts of the world, new obstacles emerged that was enough to create temporary panic for educators. The lack of ability of teachers in the mastery of information technology is one of the reasons for the unpreparedness of teachers in carrying out online learning[4]. To avoid the spread of the Covid-19 pandemic mainly to educators and learners, the Minister of Education, Culture, Research, and Technology issued a policy to hold online learning activities[5].

## **Discussion**

Online learning tests the competence of teachers in carrying out learning, especially pedagogical competition. Pedagogical competence is one of the competencies that must be mastered by a teacher. Teachers must develop these competencies so that learning activities can be carried out properly. Pedagogical competencies include: 1) mastering the characteristics of learners, 2) mastering learning theory and educational learning principles, 3) curriculum development, 4) educational learning activities, 5) potential development of learners, 6) communication with learners, and 7) assessment and evaluation.

### **Mastering the Characteristics of Learners**

No human being is the same as their character or potential. The human condition is uncertain from time to time. The situation and condition of the learner are very dynamic adjusting the space and time in which he is located, Characteristics derived from the word character, namely the characteristics, character, habits, or habits of a person that is inherent from the moment he is born. The



character of learners is the characteristics, characters, habits, or habits that learners have from birth and are shaped by their environment. The character of this student will determine his activities in realizing his ideals.

The characteristics of learners are very diverse, including 1) ethnic, 2) cultural, 3) social status, 4) interests, 5) cognitive development, 6) early abilities, 7) learning styles, 8) motivation, 9) emotional development, 10) social development, 11) moral and spiritual development, and 12) motor development. As a teacher, it is mandatory to understand that each student has different characteristics. Teachers are obliged to have the ability to accommodate each learner with various characteristics. Teachers must map the various characteristics of learners to determine properly, the right learning strategies and methods to use at the time of learning. Thus the teacher can make a plan of learners who need more attention and which learners can already be used as peer tutors for their friends.

### **Mastering Learning Theory and Educational Learning Principles**

The pedagogical competence of teachers is very complex, teachers must understand that each student has a different characteristic. Next is that the teacher must master the theory of learning and the principles of learning that education to create a learning atmosphere that is by the conditions of the student's learning style. The expertise of teachers in sorting out various learning approaches is a competency that must be honed to be easily sensitive in packaging learning that suits the interests of learners, effective, efficient, and optimal.

By mastering various learning theories and learning principles that educate it is expected that teachers can provide opportunities for learners to master learning materials, choose varied learning strategies, understand that the level of understanding of learners is not the same, adjust learning methods to the learning style of their learners, teachers must be able to assess their learners whether they have understood the material taught, and teachers must continue to learn to deepen. his knowledge of the right learning methods for his learners.

The principles of learning that must be mastered by teachers include the principles of attention and motivation, the principle of transfer and retention, the principle of liveliness, the principle of

direct involvement, the principle of repetition, the principle of challenge, the principle of turning and strengthening, and the principle of individual differences[6].

### **Curriculum Development**

The curriculum is a component of education. The curriculum becomes a map or instruction for teachers in organizing learning. The next ability that must be mastered by teachers is to develop a curriculum. After understanding the characteristics of learners, mastering learning theory, and educational learning principles, teachers are expected to develop a curriculum to provide a varied learning experience to learners. A good curriculum is a curriculum that harmonizes educational goals, the abilities of learners, and the resources possessed by an educational institution[7]. An educational institution certainly has a vision and mission specifically in organizing education. Sometimes in the development of the curriculum is carried out tucked into the typical curriculum of the institution or known as hidden curriculum[8].

Teachers should be able to convey what is meant in the curriculum to learners. The purposes and objectives and values in the curriculum must be conveyed by the way the teacher develops the curriculum. Activities to develop the curriculum can be done by planning, implementing, and evaluating the curriculum that has been developed.[9].

### **Educational Learning Activities**

Good learning is learner-centered learning. Learners become subjects in learning activities so that learning activities are carried out by learners instead of teachers. As science and technology develop, every learner has had an initial knowledge and it should be considered by the teacher when carrying out learning. There is a positive correlation between the initial ability of learners and their learning outcomes [10]. Teachers should not consider themselves to be the only source of learning learners. Teachers must give responsible freedom to learners in obtaining various learning resources.

The teacher's job is to direct and facilitate learners in learning activities with educational learning activities. The legacy of values and norms must still be taught to learners to become a generation of character by the identity of the nation. Teachers as

agents of change should be able to be an example for their learners in the ongoing educational process.

### **Potential Development of Learners**

Education is a process or planned activity to realize the learning atmosphere in the learning process so that learners can develop their potential[11]. One part of the pedagogical competence of teachers is the obligation of teachers to develop the potential of their learners. Teachers must be able to analyze the potential of their learners and direct that the potential develops by the abilities and interests of learners. Three activities in education are key in the success of the educational process in schools, namely extracurricular, intracurricular and co-curricular. These three are a unity that cannot be separated in the educational process but has their function and purpose[12].

Extracurricular activities are intended to develop the interests and talents of diving learners in school. This activity can be either academic or non-academic. Intracurricular is the main teaching and learning activity in schools by using a curriculum that has been established to develop the academic ability of learners. While co-curricular activities are activities that aim to understand learners to the material that has been taught in intracurricular activities[13].

### **Communication with Learners**

Communication is the process of delivering a "message" from one entity to another using a mutually agreed sign or symbol. The teaching profession is very complex. The demands of competence that have been stipulated in the Law must be mastered. As a teacher, the ability to communicate with learners is certainly an ability that must be mastered properly. Good communication is when the teacher delivers a "message" in the form of learning materials to learners, then learners can receive the "message" well without changing the true meaning.

Learners have different levels of understanding from each other. Therefore, teachers must be able to be good communicators by using language that can be understood by learners. The language used by the teacher to convey the learning material must be understood according to the level of understanding of learners. An academic language that means high is not necessarily understood by learners, so teachers must translate into languages that are easier to

understand. Teachers can use learning media as a tool to convey "messages" or learning materials.

### **Assessment and Evaluation**

After the learning activities take place the teacher will conduct assessments and evaluations to measure the ability of learners. Assessment and evaluation can be done in various ways, assessment can be done by test or non-test. Assessment can also be done directly at the time of learning, especially in learning activities in the form of practice or demonstrating[14].

Assessment has three realms, namely, affective, cognitive, and psychomotor assessment. The three realms have different assessment patterns in their form of evaluation. Affective assessment is assessed from the attitude of learners from various aspects. Cognitive assessment can be by using test problems that solve problems and find solutions, while psychomotor assessments can be practical activities or performances.

The study of pedagogical competence is widely researched by other researchers from various aspects. The results of research conducted found differences in the two classes of teachers. Senior teachers have better pedagogical competencies in terms of understanding the characteristics of learners, communication with learners, curriculum development, learning plans, and classroom management. In junior teachers, it was found that they were more proficient and mastered the use of information technology and the development of learning media[15].

Research concluded that innovation and pedagogy are two sides of the same coin. The balance of the two parameters must be designed according to the suitability and adaptability of educators and learners. Innovation tailor-made according to the needs of educators with the right training can go hand in hand in the long run[16]. Other researchers found that pedagogical competence is to understand the system of scientific knowledge, intellectual abilities, practical and skills, personal traits, and formations that provide self-realization, self-preservation, and self-perfection of a teacher's personality in the process of professional activities and consist of certain structural components[17].

### **Conclusion**

The seven criteria in pedagogical ability show that the task of the teacher is not only to be a teacher but also as a person who has

diverse abilities. The role of an educator is more appropriate for teachers because a teacher is not only a source of knowledge but also a director and facilitator in the learning process. Criteria that must be mastered in pedagogical competence cannot be obtained by teachers, but take a long time to be able to master them. Readiness and call of heart in undergoing the profession as a teacher becomes the determining factor of a teacher can quickly master the complement of pedagogy.

## References

- [1] A. Hamid, "PROFESIONALISME GURU DALAM PROSES PEMBELAJARAN," *Aktual. J. Penelit. Sos. Keagamaan*, vol. 10, no. 1, pp. 1-17, 2020.
- [2] U. Aiman, "Evaluasi pelaksanaan penilaian autentik kurikulum 2013; studi kasus di Madrasah Ibtidaiyah Negeri Tempel Sleman Yogyakarta," *J. Pendidik. Madrasah*, vol. 1, no. 1, pp. 115-122, 2016.
- [3] D. P. Nasional, "Undang-undang nomor 14 tahun 2005, tentang guru dan dosen," *Jakarta: Depdiknas*, 2005.
- [4] H.-C. Brauweiler and A. Yerimpasheva, "MOVING TO BLENDED LEARNING IN THE POST-PANDEMIC ERA."
- [5] Kemendikbud, *Surat Edaran Nomor 4 Tahun 2020 Tentang Pelaksanaan Kebijakan Pendidikan dalam Masa Darurat Penyebaran Coronavirus Disease (Covid-19)*. Indonesia, 2020.
- [6] O. Hamalik, "Dasar-dasar pengembangan kurikulum," 2019.
- [7] I. N. Sari, "Kurikulum Ideal untuk Indonesia," 2015.
- [8] I. N. Sari, "Kurikulum Peserta Didik Berkebutuhan Khusus di Pendidikan Dasar," 2015.
- [9] A. M. Nur, "Tugas Guru sebagai Pengembang Kurikulum," *J. Ilm. Didakt. Media Ilm. Pendidik. dan Pengajaran*, vol. 12, no. 1, pp. 59-67, 2011.
- [10] E. B. Goldstein, *Cognitive psychology: Connecting mind, research, and everyday experience*. Cengage Learning, 2014.
- [11] U.-U. Sisdiknas, "UU RI No. 20 Tahun 2003," *Jakarta Sinar Graf.*, 2003.
- [12] Y. Inriyani, W. Wahjoedi, and S. Sudarmiatin, "Peran Kegiatan Ekstrakurikuler untuk Meningkatkan Prestasi Belajar IPS," 2017.
- [13] B. Muslim, "Manajemen Pendidikan Karakter pada Kegiatan Intrakurikuler, Kokurikuler dan Ekstrakurikuler di MI Pembangunan UIN Jakarta," *EL Bidayah J. Islam. Elem. Educ.*, vol. 3, no. 2, pp. 131-144, 2021.

- [14] S. Arikunto, *Dasar-Dasar Evaluasi Pendidikan Edisi 3*. Bumi Aksara, 2021.
- [15] R. N. Emiliasari, "AN ANALYSIS OF TEACHERS' PEDAGOGICAL COMPETENCE IN LESSON STUDY OF MGMP SMP MAJALENGKA," *ELTIN JOURNAL, J. English Lang. Teach. Indones.*, vol. 6, no. 1, pp. 22–33, 2018.
- [16] C. Deák, B. Kumar, I. Szabó, G. Nagy, and S. Szentesi, "Evolution of new approaches in pedagogy and STEM with inquiry-based learning and post-pandemic scenarios," *Educ. Sci.*, vol. 11, no. 7, p. 319, 2021.
- [17] N. Aristova, "FORMATION OF PEDAGOGICAL COMPETENCE OF FUTURE TEACHERS OF HUMANITARIAN AND SOCIO-ECONOMIC DISCIPLINES," *Науковий журнал «Гуманітарні студії: педагогіка, психологія, філософія»*, no. 199.

# Flipped Classroom Assisted by WhatsApp: Bridging Mathematics Learning During Pandemic and Era of Society 5.0

Iis Holisin<sup>58</sup>

## Introduction

Society 5.0 is one of the results of technological developments made by humans. Society 5.0 was initiated by the Japan which was just inaugurated in 2019 [1][2]. This concept is a refinement of the previous concepts that already existed before. Starting from the hunting era (Society 1.0), the agricultural era (Society 2.0), the industrial era (society 3.0), and the information technology era (Society 4.0). Society 5.0 also known as the super smart society is human-centered and technology-based. Technology and education in society era are likely two sides of coin [3]. Especially after the Covid-19 pandemic. The learning process must be carried out from home in accordance with the circular letter of the Ministry of Education and Culture number 15 of 2020 known as Work From Home (WFH) [4]. The role of this technology certainly determinate the success of failure of the implementation of WFH.

Even though learning activities are carried out from home, as a teacher it is obligatory to keep going implement and monitor the learning process [5]. Since the Covid-19 pandemic, learning has been carried out online. The implementation of online learning resulted in most of those involved being unprepared. Teachers have difficulty in managing learning. Students also have learning difficulties. This is natural, because so far learning has been carried out offline. There is something new that is no less important in online learning, namely the participation of parents in accompanying their children to learn. Parents also have difficulty in accompanying their children. Some of the difficulties for parents are because they work outside the home, so they cannot intensively accompany their children to study. In addition, not all parents are able to understand the lesson well, mathematics is no exception. Such conditions do not only occur in Indonesia, but also abroad.

Mathematics has a special characteristic, namely objects that are abstract [6]. To minimize the level of abstraction of course, various

---

<sup>58</sup> Universitas Muhammadiyah Surabaya

techniques are needed in learning. Especially in online learning. Teachers must be able to choose the right method so that they can teach students easily understand the material. Many methods are used by teachers during online learning. One of them is the Flipped Classroom method. Flipped Classroom is different from learning in general. What is usually done in class is now done at home, while what is usually done as homework is done in class. Therefore, the Flipped Classroom is often referred to as reverse learning. The application of Flipped Classroom in learning can increase students' knowledge, attitudes towards mathematics and student become disciplined [7]. Students can understand subject matter from various sources when studying at home, not only relying on material sent by the teacher.

Students can also study over and over anywhere and anytime. Attractive material packaging will motivate students to learn it. Teachers are advised to use Flipped Classrooms to increase student participation in class [8]. The application of the Flipped Classroom can also be used to accommodate independent learning activities at home and to train low-grade students' learning independence [9]. Meanwhile, at the junior school level, there is no interaction between the use of the Flipped Classroom assisted by Schoology and the level of student learning independence on student learning. But the higher the student's learning independence, the maximal the learning outcomes obtained [10]. Students who have computer facilities and are able to use technology give a positive response to the Flipped Classroom method [11]

The use of the Flipped Classroom method in learning requires information and communication technology media. One of the information technology media owned by students and parents is WhatsApp. WhatsApp has become one of the most widely used media with various features offered. WhatsApp is one of the social media that can be used to send messages to and from individuals or groups. The information sent can be in the form of text messages, documents, images, photos, audio, or video [12]. WhatsApp media is also an application that is often used for discussion while studying during a pandemic [13]. Online learning through WhatsApp groups is one solution to bridge communication between teachers and students [14]. Apart from not requiring a lot of internet quota, WhatsApp includes a list of applications that can be accessed with learning quotas from the Ministry of Education and Culture.

Based on the background described above, the researcher is interested in examining how the application of the Flipped Classroom



with the help of WhatsApp can bridge mathematics learning during the pandemic and era Society 5.0. There are several questions that need to be answered through this research, namely: (1) How is the implementation of learning mathematics with the Flipped Classroom method with the help of WhatsApp media? (2) How is student participation during learning? (3) Is the completeness of student learning outcomes achieved? (4) How do students respond to learning using the Flipped Classroom method with the help of WhatsApp media?

### **Discussion**

This study uses a descriptive method with a quantitative approach. The research was conducted in one high school with a total of 27 subjects. The research subjects consisted of 13 men and 14 women. During the study, learning was carried out using the Flipped Classroom method with the help of WhatsApp media. Data was collected by using observation, test, and questionnaire techniques. Observation techniques are used to observe student activities and how the implementation of learning is carried out by the teacher. The test technique is used to determine student learning completeness after participating in learning using the Flipped Classroom method with the help of WhatsApp media. Meanwhile to find out student responses, a questionnaire technique was used. The instruments used consisted of student observation sheets, teacher observation sheets, a set of test questions, and a set of questionnaires.

Learning using the Flipped Classroom method through two stages. The first stage, before entering class, students study the material given by the teacher. The teacher sends the material by WhatsApp media. The material sent is in the form of learning videos or in the form of other teaching materials. Students are given the opportunity to study the material for several days. After that, it was continued with the discussion of the material by WhatsApp. The second stage is a meeting in the classroom. Through discussion students ask questions about material that has not been understood. This discussion activity is carried out so that students better understand the learning material.

### **Implementation of the Flipped Classroom Method with the help of WhatsApp Media**

The implementation of learning with the WhatsApp-assisted Flipped Classroom method begins with sending teaching materials to

students. One week before the lesson the teacher sends the material by WhatsApp. The goal is that students first learn the material to be discussed. In addition to studying the material provided by the teacher, students can also use other learning resources. Some of the things that become the focus of observing the implementation of learning by teachers start from preparation, implementation, time management, and the learning atmosphere. These activities are basic teaching skills that must be possessed by teachers. Teachers should have these skills so that students can receive knowledge, skills, attitudes, and values during the learning process [15]. The results showed that the teacher was very good at preparing lessons, the maximum score received was 5. Likewise at the implementation stage, the teacher did well. This can be seen from the high participation of students during learning. The teacher manages the time well, so that learning is carried out according to the specified time. The following figure is an example of teacher activities in preliminary activities through WhatsApp media (Figure 1) and in the classroom (Figure 2).

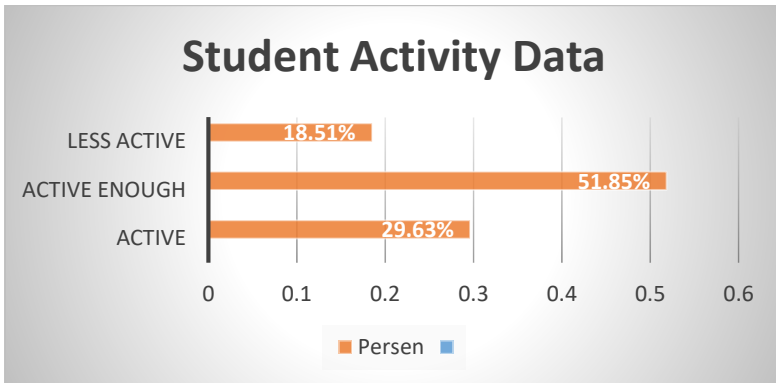


**Figure 1**



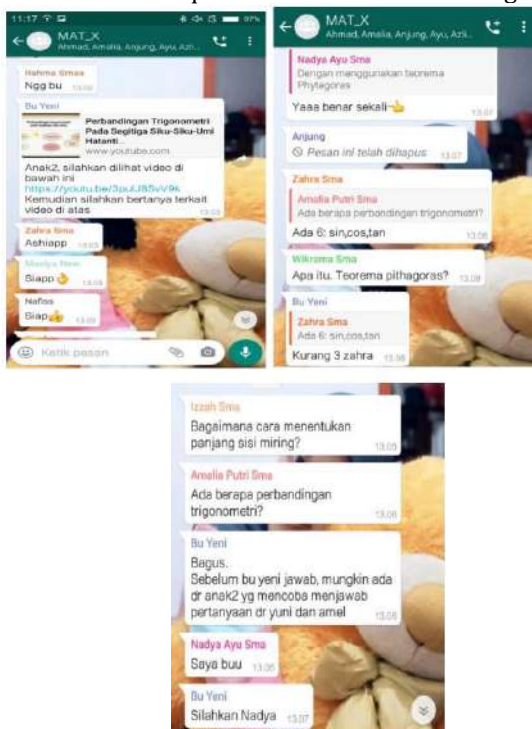
**Figure 2**

In terms of student participation during learning, the use of the Flipped Classroom method with the help of WhatsApp also makes students participate actively. Complete student participation is presented in Figure 3.



**Figure 3. Student Activity Data**

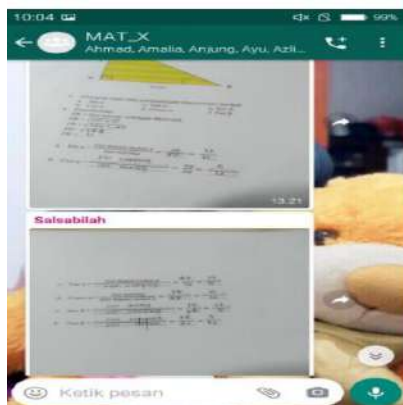
The high student participation shows high student curiosity about the material that has been studied previously. Students actively ask and answer questions as illustrated in Figure 4.



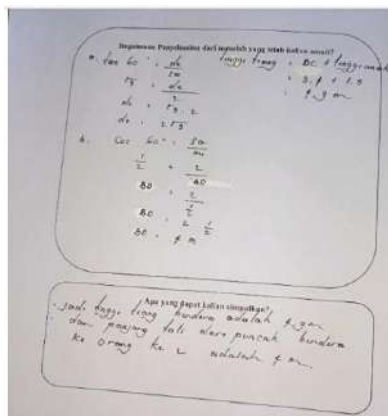
**Figure 4. Activities asking and answering questions**

The activity shown in Figure 4 illustrates the enthusiasm of students in asking questions about trigonometric ratios in right triangles. In the chat there were questions and answers between students who were guided by the teacher via WhatsApp media. Although the discussion is not face to face, the discussion is still alive. Izzah's question was answered by Nadia. Izzah asked "how to determine the length of the hypotenuse" then Nadya replied "using the Pythagorean theorem"

In addition to students being able to ask and answer questions, students are able to dig up information from various sources related to material given in the student worksheets (LKS). The task given is to observe the video given, then pour the results into the LKS (Figure 5). Students are also able to solve the given problem (Figure 6)

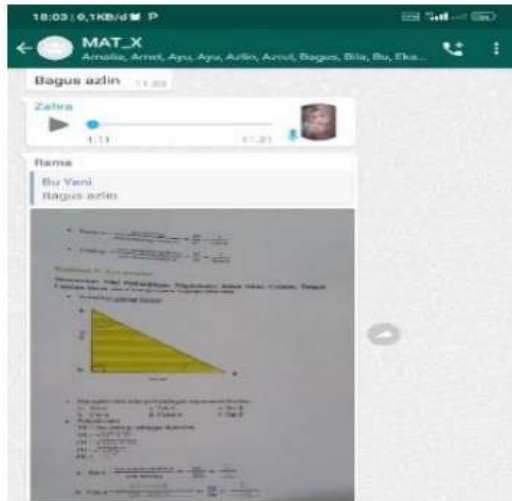


**Figure 5. Collect information**



**Figure 6. Solve the problem**

Another activity that students do is make presentations. Students make presentations using voice messages and then send the material presented in the WhatsApp group. Presentations are made by group representatives. Presentation materials are the result of collaboration in groups, because before being presented all materials are discussed in groups. The presentation process is illustrated in Figure 7.



**Figure 7. Illustration of student representatives presenting in a WhatsApp group**

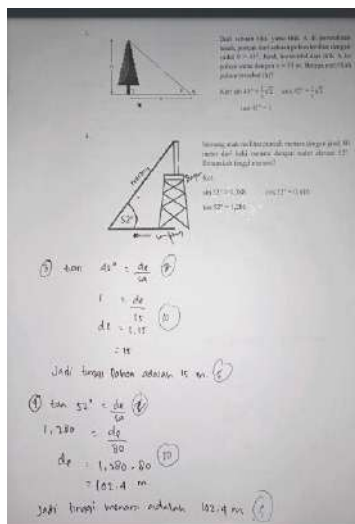
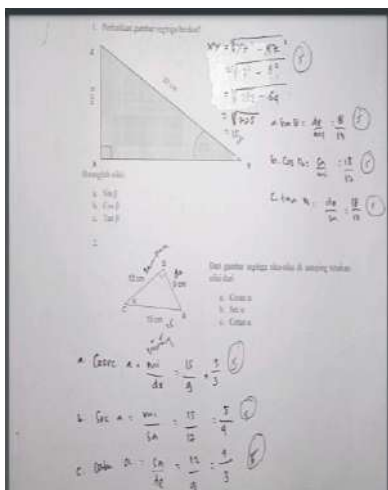
The positive thing shown from this learning process is that students are actively carrying out task. Students are able to complete and collect worksheets and participate in learning from beginning to end. During the learning process students do not experience problems with the availability of internet or network packages. Therefore, teachers are advised to use the Flipped Classroom method in learning [8]

### **Student Learning Outcomes**

Student participation in learning using the Flipped Classroom method with the help of WhatsApp is relatively high. The data also supports the achievement of student learning outcomes in the cognitive aspect. The results of data processing showed that students who achieved the Minimum Completeness Criteria were 81,48%. Although this achievement has not yet reached classical completeness, it is included in the good category. The achievement of the Minimum Completeness Criteria which is still below 85% also occurs in several uses of Flipped Classroom at the junior high school level with help of other media [16][17].

Here are some examples of students' posttest results on trigonometric comparison materials after participating in learning

using the Flipped Classroom method with the help of WhatsApp media.



In the results of student work there is an error in determining the value of the tangent  $\beta$ . As for the other students' answers are correct. Students have understood how to determine the length of one side of a right triangle through the Pythagorean theorem in both direct and story problems. Student understanding is very good. Therefore, the reverse class method is suggested to increase the pass rate of students [18]

### Student Response

Student response is defined the student's response after participating in learning with the Flipped Classroom method with the help of WhatsApp media. This method is a new thing for both teachers and students. Therefore, the researcher wanted to know how the students responded to this method. Base on the results of data analysis, it was concluded that the student's response to application of the Flipped Classroom method with the help of media in learning mathematics was in the positive category [11][7]. The indicator that obtained the highest score is that it can eliminate boredom and students find it easier to learn compared to the usual method.

Another indicator that makes a positive contribution is that students work together and collaborate with friends [7]. Students feel more active in learning and easier to understand the material. Students are serious in learning and increase learning motivation [17]

## Conclusion

The use of the Flipped Classroom learning method assisted by the WhatsApp application has succeeded in the bridging the mathematics learning process during in the pandemic and era society 5.0. The learning process carried out by the teacher done well. Student participation during learning reached 81,4%. Students actively ask and make questions. Students are able to work together. Students who achieve a minimum level of completeness of 81,48%. Positive student response. Students are more motivated to learn. Therefore, teachers are advised to use the Flipped Classroom method with the help of WhatsApp media.

## References

- [1] I. Sabri, "Peran Pendidikan Seni Di Era Society 5 . 0 untuk Revolusi Industri 4.0," *Semin. Nas. Pascasarj. 2019*, vol. 2, no. 1, pp. 342–347, 2019, [Online]. Available: <https://proceeding.unnes.ac.id/index.php/snpasca/article/view/302>.
- [2] S. Maharani, M. N. Kholid, L. NicoPradana, and T. Nusantara, "Problem Solving in the Context of," *J. Math. Educ.*, vol. 8, no. 2, pp. 109–116, 2019.
- [3] W. N. Yanuarta, A. Jaelani, and J. Purwanto, "Flipped Classroom Model : Empowering Digital Literacy for Mathematics Learning in Society 5 . 0 Model Flipped Classroom : Memberdayakan Literasi Digital Untuk Pembelajaran Matematika Pada," vol. 04, no. July, pp. 158–171, 2021, doi: 10.24042/ijsme.v4i2.9638.
- [4] K. P. dan Kebudayaan, "Surat Edaran Nomor 15 Tahun 2020," *Http://Kemdikbud.Go.Id/*, vol., no. Mei, pp. 1–20, 2020.
- [5] R. Amelia, G. Kadarisma, N. Fitriani, and Y. Ahmadi, "The effect of online mathematics learning on junior high school mathematic resilience during COVID-19 pandemic," *J. Phys. Conf. Ser.*, vol. 1657, no. 1, 2020, doi: 10.1088/1742-6596/1657/1/012011.
- [6] I. Holisin, "Pembelajaran Matematika Realistik (PMR)," *Didaktis*, vol. 3, no. 3, pp. 1–68, 2007, [Online]. Available: <http://journal.um->

- surabaya.ac.id/index.php/didaktis/article/viewFile/255/199.
- [7] F. D. Fernández-Martín, J. M. Romero-Rodríguez, G. Gómez-García, and M. R. Navas-Parejo, "Impact of the Flipped Classroom method in the mathematical area: A systematic review," *Mathematics*, vol. 8, no. 12, pp. 1–11, 2020, doi: 10.3390/math8122162.
- [8] B. Ayçiçek and T. Y. Yelken, "The effect of Flipped Classroom model on students' classroom engagement in teaching english," *Int. J. Instr.*, vol. 11, no. 2, pp. 385–398, 2018, doi: 10.12973/iji.2018.11226a.
- [9] L. R. Hidayah and A. Mustadi, "The Implementation of the Flipped Classroom for Early Grade Students in Elementary School," *J. Math. Stat.*, vol. 5, no. 1, pp. 98–106, 2021.
- [10] N. Najia, I. Holisin, and H. Mursyidah, "View of PENGARUH METODE FLIPPED CLASSROOM BERBANTUAN SCHOOLGY TERHADAP HASIL BELAJAR SISWA DITINJAU DARI KEMANDIRIAN BELAJAR.pdf." *JaMES: Journal of Mathematics Education and Science*, Bojonegoro, pp. 101–110, 2021, [Online]. Available: <http://journal.unugiri.ac.id/index.php/JaMES>.
- [11] İ. Yasar Kuzu and C. Kurtoğlu, "Research of Flipped Classroom based on Students' Perceptions," *Asian J. Educ. Train.*, vol. 6, no. 3, pp. 505–513, 2020, doi: 10.20448/journal.522.2020.63.505.513.
- [12] Y. Arifani, S. Asari, K. Anwar, and L. Budianto, "Individual or collaborative whatsapp learning? A Flipped Classroom model of efl writing instruction," *Teach. English with Technol.*, vol. 20, no. 1, pp. 122–139, 2020.
- [13] I. Holisin and H. Mursyidah, "Learning practice in mathematics education department of Universitas Muhammadiyah Surabaya during covid-19 pandemic," in *International Webinar on Education 2020: Adapting and Transforming The Activity of Teaching and Learning in South East Asian during Covid-19 Pandemic*, 2020, pp. 64–70.
- [14] T. Setiawati, "Tujuh Strategi Pembelajaran Komplementer : Solusi Cerdas di kala cemas," vol. 2021.
- [15] S. Shoffa, I. Fatin, and O. Nasio, *Keterampilan Dasar Mengajar Microteaching*, 1st ed. Surabaya: Surabaya: Mavendra Pers, 2016.
- [16] M. Kurniawati, H. Santanapurba, and E. Kusumawati, "Penerapan Blended Learning Menggunakan Model Flipped Classroom Berbantuan Google Classroom Dalam Pembelajaran Matematika Smp," *EDU-MAT J. Pendidik. Mat.*, vol. 7, no. 1, pp. 8–19, 2019, doi:



10.20527/edumat.v7i1.6827.

- [17] Farman and Chairuddin, "Pembelajaran Flipped Classroom Berbantuan Edmodo," vol. 7, no. 2, pp. 92–100, 2020, [Online]. Available: <http://jurnal.unimus.ac.id/index.php/JPMat/index>.
- [18] N. J. Shukla and E. Mcinnis, "Flipped Classroom: Success with First Year Mathematics Students," *Int. J. Soc. Educ. Sci.*, vol. 3, no. 1, pp. 32–47, 2021, doi: 10.46328/ijonses.56.

# **Women Protection Against Sexual Violence Based On Human Security in The Era of 5.0 Society**

Ika Dewi Sartika Saimima

## **Introduction**

Indonesia is currently in the concept of society 4.0 with fairly massive disruption of digital technology. The development of information technology requires the Indonesian people to get used to being integrated with the use of the internet. The development of information technology has become an inseparable part of people who want the convenience of various services digitally. Legal events that occur in society 4.0 are also the use and development of information technology that often does not pay attention to and consider aspects of human security. The use of technology today is not protected from cybercrimes which ultimately harms many parties.

Technology-facilitated sexual violence (TFSV) is an umbrella term that describes a range of sexually aggressive behaviors using digital technologies. [1]. Technology that continues to develop eventually gave birth to the concept of society 5.0. If the idea of a 5.0 society initiated by Japan is present in Indonesia, then the important principles that must be considered are ensuring physical security and information security which is the right of the community as citizens. People who are dealing with technology must make technology a tool of life. However, the development of this technology is also not free from crime so that one must be careful in its use.

The presence of the concept of society 5.0 that utilizes technology must considering human security aspects. Society 5.0 must have 6 basic literacy skills in utilizing technology, such as data literacy, namely the ability to read, analyze, and use information (big data) in the digital world. Technological literacy, namely understanding how machines work, technology applications (coding, artificial intelligence, machine learning, engineering principles, biotech). The humanities aspect becomes important when the development of information technology is carried out because often these technological developments do not pay attention to the side effects that arise. Unprepared regulations are the main obstacle in the development of information technology. Legal protection for the public when interacting with the use of information technology must be a top priority because the legal problems that occur in it are very complex.

An important issue of internet use is the occurrence of violence against women. Cases of sexual violence that occur in cyberspace are like an iceberg, will not be completed if the victim does not report what happened to him, because this is a complaint offense. Meanwhile, the current sexual regulations applied in cases of violence cannot protect women victims of sexual violence. Until now the bill on the elimination of sexual violence has not yet been passed by the government. The effort to issue the PKS Bill is because the existing rules are not specific. this results in weak protection of personal data which ultimately results in unresolved cases of sexual violence.

One of the legal problems that occur in the use of information technology, among others, is a sibling crime that occurs in women. Komnas Perempuan in its final note in 2021 reported that complaints of violence against women based on crimes reached 940 cases. [2]. Cyber-based violence was carried out by the closest people such as boyfriends, ex-girlfriends, ex-husbands, or husbands of the victims. Another widespread impact of the reach of cyberspace is that the perpetrators of violence come from unknown persons. Another crime that is often experienced by women is the occurrence of bold acts such as cyberstalking, impersonation, and the leakage of private content. This condition will certainly damage the reputation, physically and psychologically of women.

## **Discussion**

### **Human Security in the Development of Society 5.0**

UNDP in its report on human rights states that the most important thing from the aspect of human security is that a person must be able to live in his community and be respected for his human rights.[3] The main key from the aspect of human security is to be free from fear and lack.

Moreover, if the “four essential characteristics” of human security are that “It is universal, its components are interdependent, it is best ensured through prevention, and it is people-centered. [4] The human security approach is people-centered, this is due to the wide reach that threatens the survival and dignity of humans in their communities. The concept of security with an emphasis on human security must ultimately be applied to the concept of society 5.0. Advocates of human security are divided between those who are content with a narrow definition, focusing exclusively on factors that perpetuate violence and those for whom a broad definition which encompasses issues of human rights and underdevelopment is to be

preferred. [5] If the concept of society 5.0 provides comfort and convenience to humans in the use of information technology, then the state must think about and prepare legal instruments that can protect the community.

The need to protect the community can be seen in the preparation and development of the Indonesian Human Security Index in the human security approach. The Indonesian context in human security can be seen in 4 dimensions, namely security from disaster, fulfillment of social welfare, protection and utilization of diversity, and security from violence.[6]. Humans must avoid violence when using the internet. Cyber security is a top priority when people use the internet. Cyber-security is both about the insecurity created by and through this new place/space and about the practices or processes to make it (more) secure.[7] This is in line with the concept of society 5.0 where the use of the Internet of Things must be able to provide a sense of security for its users. Therefore, to avoid violence when using the internet, strict legal rules are needed.

Law is a means to regulate people's behavior. In the legal theory, it is stated that the law has an important role in society. Law has a purpose to provide well for the community in obtaining justice, legal certainty, maintaining order, and providing benefits. Roscoe Pound states that the law is the most important institution for exercising social control. Law is an important instrument to achieve social order. The main function of social control is to control "internal aspects of human nature." The relationship between individuals, society, and the state has changed from time to time, among these changes the law plays a very important role in one's life.

The law not only provides basic rights but also allows protection and maintains equality among every citizen. Every country has its laws and must be obeyed by everyone, if not followed then the punishment will be under the law. If the Indonesian legal ecosystem is not ready for the presence of the industrial 4.0 community, then it takes a hard work effort from law enforcers to overcome legal gaps when entering the era of society 5.0.

In the development of information technology, eventually, women and other vulnerable groups become more vulnerable to sexual violence, including those facilitated by information and communication technology. Women often receive bad motives when interacting on the internet. Women have also been the predominant target of image-based sexual abuse (IBSA) (colloquially referred to as 'revenge porn'), a form of cyber harassment which involves the "non-

consensual creation, distribution and threat to distribute nude or sexual images.[8] The bad motives that are received when interacting in cyberspace ultimately result in women experiencing sexual violence. The main difficulty of interacting on the internet is that there is anonymity and cross-country shows cybercrime is not an ordinary form of violence against women but is part of a transnational crime.

Law enforcement must be based on human security. Law enforcement is oriented towards justice, especially in terms of reforming law enforcement in handling cases by prioritizing the principle of justice, promoting the promotion of human rights, increasing public participation, and better monitoring mechanisms. In addition, the regulations made must be friendly to innovations that are already present in the community.

### **Legal Framework for Resolving Cyber-Based Sexual Violence**

Sexual violence is an act that demeans a person's dignity. So that the elimination of all forms of sexual violence is a necessity in the protection of the right to be free from treatment that degrades the dignity of a human being.

Indonesian law continues to strive to overcome problems regarding cyber-based violence by issuing legal regulations that continue to be refined. Positive Law that applies in Indonesia refers to laws relating to immoral offenses such as the Criminal Code and Law No. 4 of 2008 concerning Pornography, Law of the Republic of Indonesia Number 19 of 2016 concerning Amendments to Law Number 11 of 2008 concerning Information and Electronic Transactions (UU ITE). Meanwhile, to provide legal protection for victims, refer to Law no. 13 of 2006 concerning Legal Protection for Witnesses and Victims, which then includes two forms of protection rights models, namely procedural rights (the procedural rights model) covering legal processes and services (the service model) covering mental recovery

However, the problem of sexual violence is often not resolved even though it has been explicitly stated in the regulation. Many things have resulted in unresolved cases of sexual violence, including the victim's reluctance to report due to embarrassment or depression. Second, the understanding of law enforcement towards the articles in the law is still lacking and is a complaint offense. Reports of victims are an essential element. This condition certainly does not benefit the victim because many victims consider sexual violence to be a disgrace, so they choose to remain silent. Third, the mechanism of Indonesian

society is still less concerned about the problem of sexual violence. Indonesian people are used to giving bad stigma to victims of sexual violence without listening to the victim's side.

In Indonesia's positive law, cyber-based sexual violence is a complaint offense. Article 1 number (25) of Law Number 8 of 1981 concerning the Criminal Code (KUHP) states that a complaint is a notification accompanied by a request by an interested party to an authorized official to take legal action against a person who has committed a criminal offense, which harms him. Meanwhile, Article 1 of the Criminal Procedure Code, it is explained the complaint offense which can only be prosecuted because of a complaint from the aggrieved party.

The complaint offense in the phenomenon of cyber-based sexual harassment is currently subject to sanctions in Article 27 paragraph (1) of the ITE Law because the activity is carried out through electronic system media or cyberspace. Although virtual, these activities fall into the category of real legal actions. Perpetrators of cyber-based sexual harassment can also be subject to Article 281 of the Criminal Code. Article 281 of the Criminal Code states: "Threatened with a maximum imprisonment of two years and eight months or a maximum fine of five hundred rupiahs: number 1. Whoever intentionally and openly violates decency; 2nd. Whoever intentionally and in front of other people who are there against his will, violates decency.

Juridically, criminal acts in cyberspace cannot be approached with the size and qualifications of conventional law, because it will cause difficulties in proving it and many perpetrators will escape from legal bondage. The legal rules used have no juridical confirmation regarding legal sanctions that can be accepted by the perpetrators.

## **Conclusion**

Cases of sexual violence often cannot be resolved because victims are reluctant to report because of shame and depression. Law enforcement's understanding of the articles in the law that are used as the legal basis is currently still lacking, and cases of sexual violence are complaints offenses.

For cases of sexual violence, both directly and in cyberspace, it is very dependent on victim reporting. Laws related to sexual violence currently depend on provisions in the Criminal Code, the ITE Law, the Pornography Law, and Pornography. Meanwhile, regulations

that specifically deal with cases of sexual violence have not yet been passed.

Juridically criminal acts in cyberspace cannot be approached with the size and qualifications of conventional law, because it will cause difficulties in proving it and many perpetrators will escape from legal bondage. The legal rules used have no juridical confirmation regarding legal sanctions that can be accepted by the perpetrators. Therefore, the government should immediately ratify the Bill on the Elimination of Sexual Violence.

## References

- [1] A. Powell, A., Henry, N., & Flynn, "Image-based sexual abuse. In W. S. DeKeseredy & M. Dragiewicz (Eds.), *Handbook of critical criminology*," New York, 2018.
- [2] P. Komnas, "Catatan Akhir Tahun 2021," Jakarta, 2021.
- [3] R. E. Howard-Hassmann, "Human Security: Undermining Human Rights?," *Hum. Rights Quarterly*, vol. 34, pp. 88–112, 2012.
- [4] UNDP, "Human Development Report 1994," New York, 1994.
- [5] S. Tadjbakhsh and A. M. Chenoy, "Human security: Concepts and implications," *Hum. Secur. Concepts Implic.*, pp. 1–272, 2006, doi: 10.4324/9780203965955.
- [6] BAPPENAS, "Pengembangan Konsep Indeks Keamanan Manusia Indonesia 2015," *Indeks Keamanan Mns. Indones.*, vol. 1, no. 2, p. 112, 2015.
- [7] M. Dunn Caveltly, "Cyber-security The inherent insecurity of computer networks," pp. 400–416, 2015.
- [8] A. Henry, N., Powell, A., & Flynn, "ot just 'revenge pornography': Australians' experiences of image-based abuse: A summary report.," Melbourne, 2017.
- [9] Undang-Undang Nomor 8 Tahun 1981 tentang Kitab Undang-Undang Hukum Pidana
- [10] Undang-Undang Republik Indonesia Nomor 19 Tahun 2016 tentang Perubahan atas Undang-Undang Nomor 11 Tahun 2008 tentang Informasi dan Transaksi Elektronik (UU ITE)
- [11] Undang-undang No.4 Tahun 2008 tentang Pornografi,
- [12] Undang-undang No. 13 Tahun 2006 tentang Perlindungan Hukum Terhadap Saksi dan Korban
- [13] Rancangan Undang-Undang Penghapusan Kekerasan Seksual

# **A Mutualistic Talent Advantage in Teamwork Performance**

Ika Nurul Qamari

## **Introduction**

The existence of the company is always maintained, so that it competes by showing its superiority. In order for companies to excel in producing products and maintaining long-term viability, it is necessary to have a postulated conception of resources and capabilities as the basis for generating and improving performance [1]. The main basis for competitive advantage in resource-based theory is the unique combination of resources and capabilities favored by the firm. The theory of Resources Based View is an approach that is used as a resource-based strategic orientation, with the assumption that companies need managerial efforts to achieve a sustained competitive advantage [2], [3]. The increasing acceptance of internal resources as a source of competitive advantage carries the legitimacy that people are strategically important to the company's success.

There are 4 (four) empirical indicators of the potential of the company's resources to produce a sustainable competitive advantage, namely: value, rareness, imitability (ability not to be imitated), non-substitutability (ability not to be replaced). Barney points out that it is very important to highlight the strategic resources or factors in achieving the average return on assets for the company. The strategic factor market is not perfect due to the dynamics of the business environment. Under these conditions, companies cannot predict the future value generated by strategic resources. So that to gain a competitive advantage requires a more accurate estimate of the opportunities that exist, or through the profits resulting from the wrong estimation of its competitors.

Strategy theory suggests that human capital can be a source of sustainable competitive advantage [4], [5], by decoupling mechanisms that prevent workers from taking their valuable knowledge and skills to rival firms [6]. One of the most important isolation mechanisms is company-specific human capital (knowledge and skills embodied in individuals) which cannot be easily applied in other companies. In strategic planning, Javidan (1998) determined that to assist managers and strategic decision makers, it is necessary to have a clear operational definition of the important concepts of



resources, capabilities, competencies and core competencies, to identify company competencies [7].

In an effort to implement the ideas that have been set, companies are advised to consider several points, which is the process should be an integral part of the company's strategic planning process [8]. The factors that constitute the process have been summarized by linking the dimensions and sub-dimensions in the form of a hierarchy of core competencies. The main dimensions that have been created are arranged in four dimensions: resources, capacities, talents, core competencies. Each of the sub-dimensions can be described:

- 1) core competencies: building relationships and managing them,
- 2) talent: interdisciplinary work, creating jobs and service value,
- 3) capacity: branches, representative offices and units, and
- 4) resources: physical resources, income sources, human resources, shared values and field information.

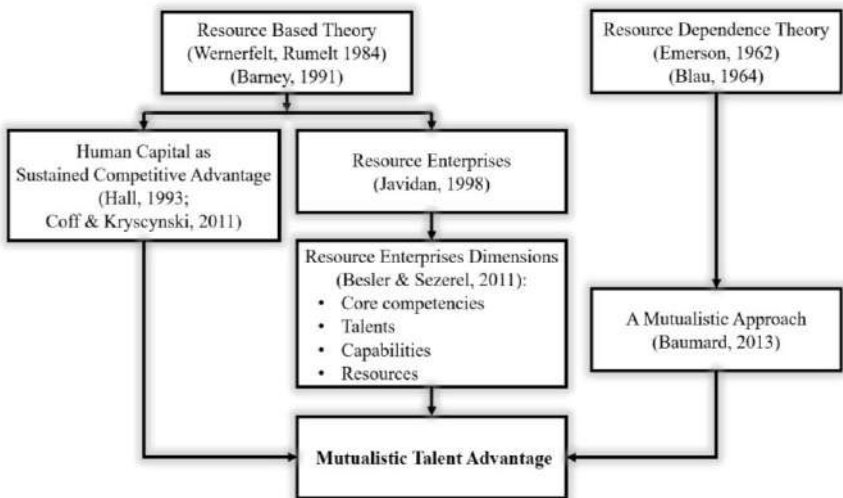
This study discusses the sub-dimension of "talent" as the main subject, which in Besler and Sezerel is interpreted as interdisciplinary work, job creation and service value. Therefore, in this study, the talent referred to is people in the organization with various competencies that are owned to complement each other in a group work. The new concept developed in this study is Mutualistic Talent Advantage (MuTA). In organizations and companies, the existence of a MuTA is always expected to create teamwork performance [15].

## **Discussion**

Resource dependency theory reveals that organizations need resources, and the tendency is to always relate well to providers of the necessary resources. This relationship will encourage the desire for easy access to resources. Emerson (1962) explains the causal relationship between the concept of power and the concept of dependence which is illustrated by the relationship between A and B. A will have an effect on B, because it is based on resource dependence. Dependence here can be understood as a major part of power. The role of power in social exchange determines their relative strength [9].

Blau (1964) contributed to the development of social exchange theory, by distinguishing between economic exchange and social exchange. Exchange is a continuum from transactional to relational. This transactional exchange places more emphasis on economic aspects, low trust levels, and short-term exchanges. While

social exchange involves a high degree of trust, emphasizing the psychological aspect, the exchange is long term. In social exchange there is no guarantee that there will be reciprocal rewards for the costs/efforts incurred because there is no agreement governing the interaction. The involvement of people in social exchanges is based on informal commitment and trust between the two parties. Whereas in economic exchange, people interact to make rational considerations, benefits, and costs. The parties to an economic exchange make an explicit agreement and the relationship between them is short term [10].



**Figure 1. The synthesis roadmap of Mutualistic Talent Advantage**

Why is an advantage needed? Advantage reflects the various goodness created by the members of the organization with all the talents that are dedicated to the betterment of the organization or company. People have their own talents, have the intention of behaving well and presenting their abilities to the best of their ability. A set of good thoughts, intentions, and behaviors will encourage good (advantage) for the organization, of course with good coordination by the leader. Therefore, the advantage in the organization occurs because of good coordination from all elements of the organization.

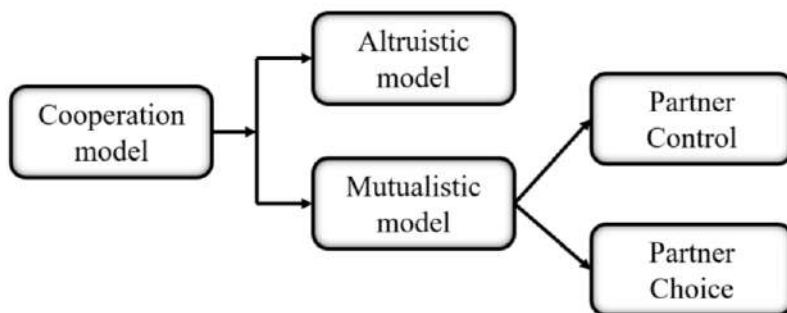
Mutualistic morality theory is based on the idea that the evolution of human cooperation is a mutually beneficial and

continuous interaction. In this theory, the mechanism of evolution (partner choice) leads to the type of behavior (fairness-based) observed in humans. Baumard describes how people adapt to their environment, competing for partners with mutually beneficial interactions, in a view of fairness that rewards individual effort and talent [11]. This explains why the same process does not result in a view of justice, which also gives a genuine appreciation of luck. The basic mechanism underlying their partner selection model is that potential partners should be rewarded with the marginal value of their contribution to mobile partner interactions. Given this mechanism, it seems that following partners should also be rewarded for contributions that reflect pure luck.

The mutualistic approach provides an explanation of the evolution of morality, which makes subtle predictions about how individuals are likely to cooperate. This predicts a very specific pattern, individuals should seek to contribute and distribution in collective action proportional to one another; so that they must effectively make their assistance proportionate to their capacity; and vice versa. This prediction fits a certain pattern described by the contractalist philosopher. Contractualist philosopher explain morality in terms of an implicit contract, but they cannot explain its existence. On a psychological level, it is justice that directs humans to behave as if they are bound by a real contract.

Furthermore, Baumard explains in detail that there is a form of social interaction relationship between "actor" and "recipient" whose consequences are accepted by both the actor and recipient with "profit" (+) or "loss" (-). Benefits and disadvantages are measured by direct suitability. If the behavior is beneficial to the actor and detrimental to the recipient (+/-) by Baumard it is called *selfishness*. Behavior that is detrimental to the actor and beneficial to the recipient (-/+) is called *altruism*. Behavior that is detrimental to the actor and detrimental to the recipient (-/-) is called *spite*. Meanwhile, behavior that is beneficial for both the actor and the recipient (+/+) is called *mutualism*. Cooperation is a social behavior that benefits the recipient, therefore, cooperation can be altruistic or mutualistic. The mutualistic model illustrates engagement in mutually beneficial cooperation for both the actor and the recipient. Mutualistic model consists of types, namely partner control and partner choice. In the partner control model, partners are given, not voted, and the central issue is preventing partners from cheating. Instead, a partner choice model is currently being developed, where

individuals can choose their partners and the emphasis is less on preventing fraud in "choosing" and being "chosen" as the right partner.



**Figure 2. Cooperation model pictography (Baumard et. al., 2013)**

The cooperation model can be illustrated in Figure 2. The cooperation model consists of two models, namely the altruistic model and the mutualistic model. While the mutualistic model includes two kinds, namely partner control and partner choice.

The explanation above shows that in working in a team, everyone leads to altruism or mutualism. Altruism will occur when there are members who voluntarily sacrifice for others and benefit others on the team. In addition, mutualism will occur when organizational members have activities that lead to individual performance and have an impact on team performance. Therefore, in this study, we chose the term "mutualistic" which indicates that in a team, each member contributes according to his or her competence and is committed to achieving organizational goals.

The concept of MuTA is a derivation of Resource Based Theory and Resource Dependence Theory which has elements of mutualistic, talent and advantage. The synthesis is explained based on the description and illustration in Figure 1. The proposition of "mutualistic talent advantage" in encouraging teamwork performance that has an impact on organizational performance is the activity or process of organizational members to contribute to each other in creating and establishing relationships that have an impact on added value to the organization, by sharing knowledge, absorbing each other's competencies, harmonizing the spirit of cooperation,

establishing mutual commitments, and the ability to create common goals.

MuTA was developed with 5 (five) characters: 1) sharing knowledge, 2) absorbing each other's competencies, 3) harmonization of work spirit, 4) ability to make commitments, and 5) ability to solve problems. The five characters are indicators of a MuTA that is expected to improve teamwork performance. These indicators reflect the concept of MuTA.

### **A Talent Architecture**

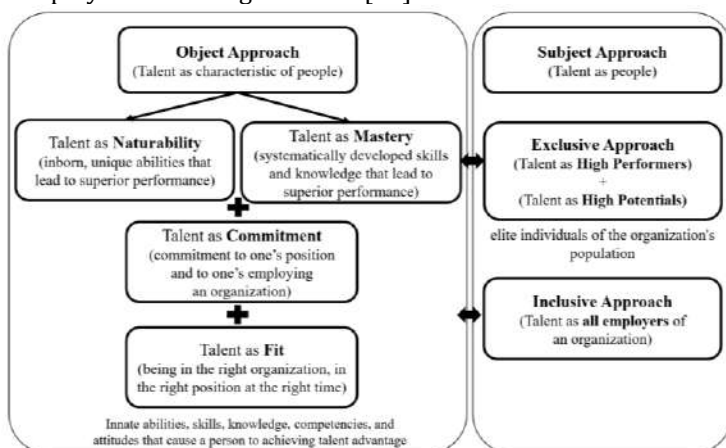
A talent management architecture, according to Sparrow (2015) is a combination of systems, processes and practices developed and implemented by organizations to ensure that talent management is implemented effectively [12]. Assuming an architecture-like operation, the talent management literature has indirectly relied on human capital thinking to make a series of value claims. This thinking explains that value lies in the unique set of knowledge, abilities, contributions, commitments, skills, competencies and abilities possessed by organizational talent. Talent that is valuable, rare, difficult to imitate and hard to replace, enables organizations to implement strategies to create value and achieve sustainable competitive advantage. Talented employees are distinguished from other employees by the capital they possess, which enables them to make a difference and add value to their organization. Talented employees are an organization's strategic asset and manipulated resource, which has the potential to contribute to value creation.

Schiemann (2014) also notes that talent architecture must be managed effectively within the corridors of the talent life cycle [13]. Company leaders need to identify existing talent and map out people who have unique talents to be placed in strategic positions that make strategic contributions to improving organizational performance.

### **Talent Management**

Gallardo-Gallardo et al. (2013) discusses talent in the world of work with two approaches, namely the object approach and the subject approach. In the object approach, talent is defined as 4 (four) personal characteristics, namely 1) talent as a natural ability, 2) talent as mastery, 3) talent as commitment, 4) talent as something that fits between individuals and their work. In the subject approach,

talents are defined as people, which are grouped with two approaches: the exclusive approach and the inclusive approach. In the exclusive approach, talent is seen as part of the organization's population that has high performance and high potential, which amounts to about 10 percent. The inclusive approach views talent as all employees of the organization [14].



**Figure 3. The Concept of Talent in Organization (Gallardo-Gallardo et. al., 2013)**

Talent management has become an interesting topic in the discussion of HR management, employee development and researchers [16]. Talent management focuses on developing talent that is strategically important to the future of the organization. Research in talent management focuses on managerial or leadership talent, but there are other important career tracks within an organization. While it is important to prepare employees for promotion to management, technical skills such as technicians are often the key to competitive advantage in the digital knowledge economy. Developing and building talent leadership supports a global expansion strategy and should be linked to the talent management function. In addition, building strengths for digital leadership positions, important in supporting growth strategies, also creates opportunities for talent development and enhances the capabilities of high-potential individuals [17].

## Conclusion

Talent is the competence, commitment, and contribution of people in the organization. While the talent of each person is different

according to the grace of God given to each person. Organizations manage the various talents that exist in each person for strategic purposes. So that everyone contributes to the achievement of organizational goals in accordance with their respective talents. It is important to identify and place people in the organization according to their talents, so that they can contribute optimally to the organization. This is a Mutualistic talent advantage which is the best collaboration of people in teamwork which is expected to provide optimal achievement on teamwork performance which will have an impact on organizational performance.

## References

- [1] Shipilov, A., & Godart, F. "Luxury's talent factories. Harvard Business Review," vol. 93, no. 6, pp. 98-104. 2015.
- [2] Barney, J. 1991. "Firm Resources and Sustained Competitive Advantage," Journal of Management. vol. 17, no. 1, pp. 99-120. 1991, doi.org/10.1177/014920639101700108.
- [3] Wernerfelt, Birger. "A resource-based view of the firm," Strategic management journal, vol. 5, no. 2, pp. 171-180, 1984, doi.org/10.1002/smj.4250050207.
- [4] Coff, Russell, and David Kryscynski. "Invited editorial: Drilling for micro-foundations of human capital-based competitive advantages," Journal of management, vol. 37, no. 5, pp. 1429-1443, 2011, doi.org/10.1177/0149206310397772.
- [5] Hall, Richard. "A framework linking intangible resources and capabilities to sustainable competitive advantage." Strategic management journal, vol. 14, no. 8, pp. 607-618, 1993, doi.org/10.1002/smj.4250140804.
- [6] Schroeder, Roger G., Kimberly A. Bates, and Mikko A. Junntila. "A resource-based view of manufacturing strategy and the relationship to manufacturing performance." Strategic management journal, vol. 23, no. 2, pp. 105-117, 2002, doi.org/10.1002/smj.213.
- [7] Javidan, Mansour. "Core competence: what does it mean in practice?." Long range planning, vol. 31, no. 1, pp. 60-71, 1998, doi.org/10.1016/S0024-6301(97)00091-5.
- [8] Besler, Senem, and Hakan Sezerel. "Core competences in non-governmental organizations: A case study." Procedia-Social and Behavioral Sciences, vol. 24, pp. 1257-1273, 2011, doi.org/10.1016/j.sbspro.2011.09.106.
- [9] Emerson RM. "Power-dependence relations," American

- sociological review, Feb 1, pp. 31-41, 1962.
- [10] Blau, P. M. "Exchange and power in social life," Transaction Publishers. 1964.
  - [11] Baumard, N., J.-B. André, and D. Sperber. "A mutualistic approach to morality: The evolution of fairness by partner choice," Behavioral and Brain Sciences, vol. 36, no. 01, pp. 59-78, 2013, doi.org/10.1017/S0140525X11002202.
  - [12] Sparrow, Paul R., and Heba Makram. "What is the value of talent management? Building value-driven processes within a talent management architecture." Human resource management review, vol. 25, no. 3, pp. 249-263, 2015, doi.org/10.1016/j.hrmr.2015.04.002.
  - [13] Schiemann, W. A. "From talent management to talent optimization," Journal of World Business, vol. 49, no. 2, pp. 281-288, 2014, doi.org/10.1016/j.jwb.2013.11.012.
  - [14] Gallardo-Gallardo, E., N. Dries, and T. F. González-Cruz. "What is the meaning of 'talent' in the world of work?," Human Resource Management Review, vol. 23, no. 4, pp. 290-300, 2013, doi.org/10.1016/j.hrmr.2013.05.002.
  - [15] Qamari IN, Ferdinand AT, Dwiatmadja C, Yuniawan A. "Transformative interaction capability: the mediating role between quality of work life and teamwork performance," International Journal of Quality and Service Sciences, vol. 12, no. 2, pp. 133-148, 2020, doi.org/10.1108/IJQSS-01-2019-0008.
  - [16] Collings, D. G. "Toward mature talent management: Beyond shareholder value," Human Resource Development Quarterly, vol. 25, no.3, pp. 301-319, 2014, doi.org/10.1002/hrdq.21198.
  - [17] Dubravská, Mariana, and Emilia Solankova. "Recent trends in human resources management in selected industry in Slovakia and the Czech Republic." Procedia Economics and Finance, vol. 26, pp. 1014-1019, 2015, doi.org/10.1016/S2212-5671(15)00924-7.



# Corpus and Data-Driven Learning: Big Data for Language Teachers

Ikmi Nur Oktavianti

## Introduction

Language teaching activity conducted in the EFL context relies significantly on the teaching materials and classroom interaction [1]. As a foreign language, the target language is not widely used daily. This condition itself is not adequate to provide rich and quality language input for the learners. In terms of the English language, learners in Indonesia might get exposure from many aspects due to the advance of Internet technology. However, not all learners are highly motivated; thus, teachers still hold the primary roles for their learning achievement. To help the teaching activity, teachers then use textbooks as the main resources. Surprisingly, some studies have shown that textbooks might not be the best teaching and learning resources in the EFL context [2]–[4].

Some previous studies show the differences in language presented in the textbooks and actual use of English in several aspects, such as modal verbs [3], [5]–[7]. For example, necessity/obligation modals are overused in an Indonesian EFL textbook for senior high school. Meanwhile, in COCA, prediction modals are the most frequent ones [8]. Another study also demonstrates that the use of adverb collocates of *good* and *great* in senior high school textbooks is restricted to *very*, which is inadequate [4]. Several studies also prove that textbook conversations are not natural and do not represent actual English conversations [9], [10]. Considering that the writers of the textbooks in the EFL context are mostly not native speakers of English, this phenomenon is inevitable. However, there must be an alternative solution to overcome these mismatches.

Related to the actual practice of English, it is important to be grammatically correct and naturally used. Considering that English is still a foreign language in Indonesia, this is such a challenging task for language teachers. Therefore, to ensure the quality of our language input, it is recommended to consult native speakers. However, it is nearly implausible to consult native speakers daily in language teaching activities in the EFL context. Thus, it is essential to consider using language-related technology. It is now possible to collect native speakers' use of English massively and digitally to consult this text

collection for the naturalness of 'our' English. This large-scale text collection is the manifestation of *big data* in the language context.

*Big data* is related to data management technology. Big data enables people to store, manage, and manipulate vast amounts of data at the right speed and time to gain the right insights [11]. There are some characteristics of big data, namely (1) a large volume of data, (2) high velocity of data, (3) a wide variety of data [11]. Since Industrial 4.0, where people start inventing the Internet and information is much easier to access, we can see the growth of big data. People in various fields, such as economics, use big data to make a comprehensive analysis of economic trends, etc. [12]. In terms of language data, it is plausible to compile various texts from various sources to a very great extent. We can have more comprehensive resources to serve language research once conducted on a smaller scale (e.g., a movie, a novel, a news article, etc.). Concerning the nature of language use as a collective practice [13], the analysis results are also more valid and representative.

More interestingly, this text collection is not only used for language research, but it is also applicable and beneficial for language teaching and learning [14], [15]. Since this collection provides many authentic examples, teachers and learners can better understand language use. This huge text collection is called *corpus*. However, the ELT practice seems to be unaffected by the emergence of corpus technology, and relatively few teachers and learners know about this valuable resource and experience the use of a corpus themselves [16]. Thus, it is crucial to introduce corpus and use it for language teaching and learning, especially in the EFL context like in Indonesia.

## **Discussion**

Corpus (*pl. corpora*) can be defined as the large collection of texts stored digitally in machine-readable formats [17], [18]. The collection of texts is collected from naturally occurring language data. They are authentic, meaning that they are compiled from the actual use of English, such as newspapers, magazines, fiction, and academic articles. Some corpora also contain spoken language data, such as TV shows, public lectures, movies, etc. Thus, we can say that it is a representative collection of language that can be used to make statements about language use. A corpus has the characteristics of being empirical since it collects and provides actual patterns of use in natural language texts, being authentic because it compiles the language data from authentic sources, and register-based because it

differentiates spoken vs. written language data [18]. A corpus usually consists of millions or billion words that require computer software or computational mechanism to do the analysis, such as frequency analysis, concordance analysis, collocation analysis, n-gram analysis, etc. [19]. Because the size of the text collection is massive, it is therefore quite valid as a resource for language teaching and learning.

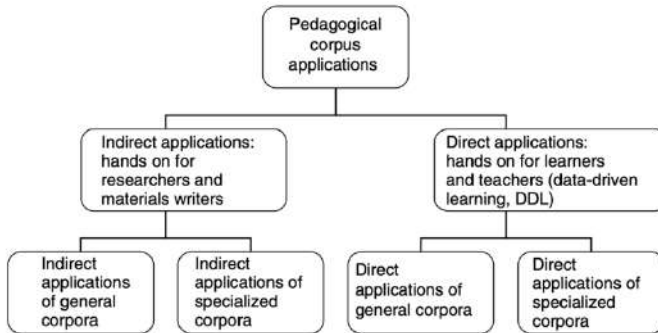
There are many English corpora available online and accessible for free. First, there are several corpora used for general purposes and needs (standard language, synchronous language), such as *Corpus of Contemporary American English* (COCA), *British National Corpus* (BNC), *Global Web-based English* (GloWbE), etc. There are also some specialized corpora, such as *Michigan Corpus of Upper-Level Student Papers* (MICUSP), *Corpus of African American Languages* (CORAAAL), *Corpus of Historical American English* (COHA), to serve specific purposes, e.g., documentation of ancient languages, documentation of vernacular languages, documentation of learners' language. However, in this chapter, I focus on the use of general reference corpora for language teaching and learning due to some reasons, such as (a) the size is gigantic (thousand million or hundred million or billion words), (b) it is updated, and (c) it prioritizes standard language which is in line with the 'type' of the language taught at schools. I highly recommend using *COCA* and *BNC* as the consultation corpus for teaching and learning activities.

### **Corpus for Language Teachers**

The use of corpus in English language teaching is not new. Corpus technology has been used as a basis for teaching and learning languages for more than 25 years. One of the earliest corpora was in the 1980s when John Sinclair (professor in the Department of English) collaborated with Collins, publishing on the *COBUILD* project in pedagogically oriented lexical computing [16]. A much earlier attempt to improve English language teaching by collecting authentic sources was the *General Service List* (GSL) compiled by Michael West [16]. This list presents the most frequently used words in the English language, which was determined based on empirical bases. It is not surprising that all major learners' dictionaries of English are now based on constantly updated multi-million-word language databases. Not only dictionaries, but some coursebooks are also now written based on the results of corpus investigation or corpus consultation [20].

There are two types of corpus applications for language teaching and learning. The first is the indirect use of corpus in the

classroom which means corpus is used as a teaching and learning media and resource. Despite being used directly, corpus can also be used indirectly, such as shown in figure 1 [16].



**Figure 1. Corpus use for language teaching and learning**

This chapter focuses on using a corpus directly in the classroom, which is known as *Data-Driven Learning*.

### **Data-Driven Learning**

An attempt to minimize the discrepancies or mismatches of languages we teach and the actual use of English can be made by using a corpus as a teaching media. Corpus can be used directly in the classroom for practicing an inductive approach. Data-Driven Learning (DDL) is the activity of using a vast language database to explore the structure, pattern, meaning, etc. [14], [21]. Tim Johns first introduced this term when working with parts of the *COBUILD* corpus [21]. There are some applications of corpus use in the DDL practice. Teachers can use a corpus, for instance, COCA, to check the most commonly used grammatical patterns and involve the students in this activity. Here is an example of investigating the prepositional collocate for *interested*.

RANK	FORM	FREQ	TOTAL	UNIQUE
1	interested in	5873	95,373	4
2	interested by	86		
3	interested at	69		
4	interested for	64		
5	interested on	52		
6	interested about	55		
7	interested to	51		
8	interested with	47		
9	interested as	29		
10	interested from	20		

**Figure 2. Results of corpus investigation (*interested + prep*)**

Figure 2 demonstrates the natural combination for *interested + prep* is *interested in* having the highest frequency of use in the COCA and leaving the rest as minor variants. By doing this activity, students can experience the investigation themselves and develop their inductive thinking. For the full contexts, COCA can also display the use of *interested in* as in figure 3.

RANK	SOURCE	CONTEXT
1	unroors.blogspot.com	where i plan to store all of our flipped classroom videos. if you're <b>interested in</b> checking out the videos that jack & i made, you can access my
2	adsci.org	points of view, and while trying to suss out why i can be so <b>interested in</b> political issues but why most people i know could not care less, it
3	adsci.org	2 i am heartens away from the Presidency. A Rollis, not only was i not <b>interested in</b> the most recent Super Bowl, i forgot what Sunday it was going to be
4	adsci.org	i am aware that it is not a football. if people who are not <b>interested in</b> sports behave a lot like people who only have a faint awareness of politics
5	adsci.org	like to pretend the entire world is as aware of, open-minded about, and <b>interested in</b> the same things they are. it is short, here are some hard
6	dailykes.com	234920 it seems clear that Mitt Romney is not at all <b>interested in</b> sharing his tax returns with the American voters. For now, he's
7	dailykes.com	555 in California trying to ban gay-marriage between adults, but is not at all <b>interested in</b> campaigning against the Mormon fundies in Utah and elbow
8	lucamacs.com	a higher level on future projects, but you'll also demonstrate that you are <b>interested in</b> them and what they do. People want to know their work matters
9	socialgeographic.com	knows that, so it propagates the ignorant monster idea into popular understanding. Anyone <b>interested in</b> how real values behave should watch the R
10	socialgeographic.com	are difficult to comprehend. Brown Goode is nearly forgotten except by those of us <b>interested in</b> Washington's cultural institutions and especially how
11	wiki.com	as they'll vacate by offering additional welding classes on Tuesdays and Thursdays for welders <b>interested in</b> upgrading their skills or getting certified, or
12	wiki.com	program to train people in operating tracks. He says the course would assist those <b>interested in</b> earning a CDL. The six-week program would consist of
13	was.thereanyof.com	major users from a diversity of businesses – not just technology – that are very <b>interested in</b> that building, and most of those discussions are for the f
14	log.burwell.com	Face it i shouldn't be surprised. i recently read that small business owners <b>interested in</b> HCR Silver could pick up the bundle at Staples for \$499. Accord
15	foelke.com	to what this means for the winter to come. The only thing i'm <b>intereste</b> d in, and probably morose in December than now is the amount of snow on
16	antioch.com	spots where the movie promoters know we'll watch any news about movies were <b>interested in</b> , so they throw us three Banks as a joke! And i sat
17	alivices.com	states on their own to face disasters. It is sad that no one is <b>interested in</b> climate change, torture, G8ms, spying on our own citizens, Bradley
18	tegs.gdsw.org	capturing when we think about measuring "the best" think tanks. i'm <b>interested in</b> your idea of an "Inventory of practice" and presence abroad. Do
19	log.ethaly.com	page results will be boosted more and more by social influencers. if you are <b>interested in</b> going deeper into the impacts of social media on SEO i sugg
20	ocean.worldevents.com	to white people. i recommend this 18-minute documentary video for those who are <b>interested in</b> hearing the Eastern Cherokee case as it is actually weaker r

**Figure 3. Examples of *interested in* from COCA**

Furthermore, students can also observe the examples provided by the corpus and identify how they are used. From these examples, students can also generate patterns. This activity strongly supports discovery learning and makes students more active in the learning process.

Another corpus application in the classroom is for meaning identification. The word *common*, for example, conveys several meanings. This word can mean differently depending on the context,

and a corpus can be the perfect tool to identify which meaning belongs to which context of use. Below are some possible meanings of *common* from the Oxford Dictionary.

com·mon | ˈkɑːmən |

adjective (commoner, commonest)

- occurring, found, or done often; prevalent: *salt and pepper are the two most common seasonings* | *it's common for children to have middle ear infections.*
  - (of an animal or plant) found or living in relatively large numbers; not rare: *you might spot less common birds such as the great spotted woodpecker* | *the swordfish is not common in European waters.*
  - denoting the most widespread or typical species of an animal or plant: *the common blue spruce.*
  - ordinary; of ordinary qualities; without special rank or position: *the dwellings of common people* | *a common soldier.*
  - (of a quality) of a sort or level to be generally expected: *common decency.*
  - of the most familiar type: *the common or vernacular name.*
- shared by, coming from, or done by more than one: *the two republics' common border* | *problems common to both communities.*
  - belonging to, open to, or affecting the whole of a community or the public: *common land.*
  - Mathematics belonging to two or more quantities.
- British showing a lack of taste and refinement; vulgar: *she's so common.*
- Grammar (in Latin and certain other languages) of or denoting a gender of nouns that are conventionally regarded as masculine or feminine, contrasting with neuter.
  - (in English) denoting a noun that refers to individuals of either sex (e.g. *teacher*).
- Prosody (of a syllable) able to be either short or long.
- Law (of a crime) of relatively minor importance: *common assault.*

Figure 4. Meanings of *common* (adj)

Teachers can direct the students to use the KWIC feature in COCA to observe the use of 'common' from authentic sources, as shown in figure 5. Teachers can assign the students to identify the meaning of *common* in the concordance lines

1	2013	MOV	Dracula: The Dark Prince	and witty theives. Heron. I see there is nothing	common	about you, either. - MEN: Oh. - I
2	2012	BLOG	pathres.com	# Michael # Probably he was just summarizing the two most	common	circulations. Though I'm sure some people have claimed both
3	2004	TV	The Closer	registered to archie leach. That's one of what's	common	places. I need to talk to him, will. If
4	2002	NEWS	CSMonitor	for that very reason. # Bobby seems are especially	common	among this group. joke sky. because most workers are paid
5	2018	MAG	Medical Xpress	operation and reserving the right to refuse to operate was more	common	among orthopedic surgeons. # * Due to external pressures and
6	2012	BLOG	niehenhayden.com	the real scientific concept of a Schenckian most	common	ancestor. I think. and a mitochondrial DNA most recent common
7	2012	WEB	...entificamerican.com	those of lungfish; more probably both are derived from a	common	ancestral condition. # Re: "Around 4.5 billion years ago
8	2007	ACAD	ThoracicCardio	Kischner wires for the fixation of fracture dislocations is a	common	and sensible practice. We report here a case of migration of
9	2006	ACAD	SchoolPsych	. However, three types of tasks appeared to be most	common	and most not supported by evidence of technical adequacy.
10	2016	SPOK	PBS, NewsHour	He blames the decline on global trade policies. Using a	common	anti-immigrant trope, it blames one group in particular.
11	2014	NEWS	Denver	falls into one about once a week. But much more	common	are the eye flutters. In medical terms, they are
12	2005	NEWS	SanFrancChron	Francisco will tell you underpricing is a marketing tactic as	common	as stapling or photocopying photographs. # * If I was on
13	2007	MAG	America	an internationally guaranteed special statute for Jerusalem.	Common	backing of the statute placed the Greek Orthodox Patriarchate
14	2004	ACAD	Adolescence	period for a broad group of adolescent girls. # The	Common	reliefs case also showed change for the intervention
15	2012	WEB	cother.uni.edu	cheerfulness. " we'll always be better friends than a	common	brother. You'll find out that pretty
16	2003	NEWS	USAToday	used in the Vietnam War. The BLU-26 is the most	common	bombied found weapon in Laos. # * Duet: A bomb that
17	2007	MAG	Environmental	. Field Notes from a Catastrophe, as its 2007 "	Common	book, * which every incoming Freshman is required to read.
18	1999	MAG	NaturalHist	genes maintain a constant level in populations: they are fairly	common	but do not affect the majority because their spread is
19	2012	BLOG	...om.blogspot.com	of the building as soon as it looked about the "	Common	between father and son-in-law. " said Eric Hughes, a spokesman
20	2012	WEB	gjonrgon.com	" Allen added that although the planned building has	common	characteristics of an Apple Store, it also has unique design
21	1992	MAG	NewsRepubl	comes close to denying that Americans of African race share a	common	citizenship. " Some people might deny that we do. Yet a
22	2012	BLOG	...ence.wordpress.com	Arabic-speaking workers will have to realize that they share a	common	class enemy: squabbles that appear religious in nature have to
23	2012	WEB	biomedcentral.com	cluster could possibly represent different " windows " of a	common	fundamental course. the way it would appear in daily practice.
24	2012	BLOG	niehenhayden.net	chronic sinusitis, head trauma from an accident or simply the	common	fold. # Research has shown that 50% of patients with e
25	2012	BLOG	niehenhayden.net	House, driving the policy debate -- that is not a	common	combination. but it's what we need to aim for.
26	2006	ACAD	EurNoiseThroat	"The most common are otitis and middle ear infections. Less	common	complications include meningitis, otitis media, and
27	1999	NEWS	Houston	and stanch his conditions with a smile and courtesy to avoid	common	courtesies to his opponents. In the political arena. # Voters

Figure 5. Some concordance lines of *common*

DDL with a corpus can also be done to deal with synonyms. The words *pretty* and *beautiful* are synonymous. However, synonyms do not mean they have the same meaning, and they are not always interchangeable. Therefore, it is essential to equip the students with sufficient knowledge. With the assistance of a corpus, teachers can provide a more useful and reliable resource to tell the difference. In COCA, for example, there is a feature to compare synonyms. Here is the result for *pretty* and *beautiful*.

WORD 1 (W1): PRETTY (1.84)					WORD 2 (W2): BEAUTIFUL (0.54)						
	WORD	W1	W2	W1/W2	SCORE		WORD	W2	W1	W2/W1	SCORE
1	MUCH	31809	0	63,618.0	34,542.0	1	FRIENDSHIP	103	0	206.0	379.4
2	SURE	8749	0	17,498.0	9,500.7	2	KIDS	101	0	202.0	372.0
3	SOON	3259	0	6,518.0	3,539.0	3	EXPERIENCE	82	0	164.0	302.0
4	GOOD	22863	6	3,810.5	2,068.9	4	HOMES	81	0	162.0	298.4
5	AMAZING	1368	0	2,736.0	1,485.5	5	MOMENTS	55	0	110.0	202.6
6	OBVIOUS	1347	0	2,694.0	1,462.7	6	SPIRIT	54	0	108.0	198.9
7	TOUGH	1153	0	2,306.0	1,252.1	7	TRIBUTE	54	0	108.0	198.9
8	DARN	1030	0	2,060.0	1,118.5	8	SOUL	106	1	106.0	195.2
9	FUNNY	979	0	1,958.0	1,063.1	9	FORM	48	0	96.0	176.8
10	EASY	1577	1	1,577.0	856.2	10	SON	95	1	95.0	175.0

**Figure 6. Collocates of *pretty* and *beautiful* in COCA**

Figure 6 presents the collocates of *pretty* and *beautiful* in COCA, and it is evident that they are used differently. The word *pretty* is more frequently used as an adverb to modify adjectives (e.g., *good*, *sure*, *amazing*, *obvious*, *funny*, etc.). In contrast, the word *beautiful* is an adjective to modify nouns (*friendship*, *kids*, *experience*, *homes*, *moments*, etc.). In other words, *pretty* is used more frequently as an adverb which makes it not interchangeable with *beautiful* to all extents. Teachers and learners can maximize the learning experience and better understand the target language by having empirical and massive data.

The teachers might also simplify DDL experience. The raw results of corpus search can be extracted and selected due to learners' proficiency and needs. Below is an example of the materials on necessity/obligation modals, *must* and *should*, taken from a corpus and adjusted into a more straightforward presentation in figure 7.

1	said, anybody who is interested in becoming a (unclear) in nineteen ninety three,	<b>must</b>	register an interest on sixteenth this year, which is really
2	He should know about them shouldn't he? (unclear). Well we	<b>must</b>	(pause) that's why, certainly have to, before (unclear)
3	A B C whenever they are put in these cardboard boxes they have to be sorted so somebody	<b>must</b>	sort them.
4	A B C're not asking (unclear) sorting, oh I see. Erm (pause) so there	<b>must</b>	be somebody responsible and I think if, if we write swimming pool and people
5	A B C collecting cost. Because the (pause) money they can get for this (pause) mixed paper	<b>must</b>	be a pittance. Mm. Almost hardly worth their while but (unclear)
6	A B C Charity shops. (An (pause) or the other item that we	<b>must</b>	mention is any extra plastic bags Yeah, I'll ask about plastic bags
7	what see says any rate on Monday. But I don't think we	<b>should</b>	give her too long, cos she's got herself into (unclear)2. Mm.
8	A B C at Kathy (-----) says, she's afraid of being left out, if there	<b>should</b>	be a, another Tory Government, so a lot of people are in the
9	A B C it and to say how, how they tackled it, so I think it	<b>should</b>	be an interesting meeting, hopefully we'll get a few, you know interesting people
10	A B C women's committee and they assure me that they, the hospital says these tests	<b>should</b>	come through in a week, at the most three week'
11	A B C if we established a, a demand, and I don't see why we	<b>shouldn't</b>	have a bash at. Well then I have the inspector. (unclear)
12	A B C S A branch, you know, I don't see why, why we	<b>shouldn't</b>	give it a try. There is one at the (unclear)

**Figure 7. Concordance lines of *must* and *should***

The examples provided in figure 7 are authentic and natural, which can support the students in understanding the actual use of *must* and *should*. The application of DDL using a corpus or some corpora might be beneficial for vocabulary teaching [22] and grammar teaching [23].

### **The Benefits and the Drawbacks of Corpus**

Corpus in language teaching and learning offers some benefits since they are based on actual language use, meaning that teachers do not invent the examples [20]. The sources of the examples are authentic, which guarantee the expressions or word combinations or patterns are naturally used in the English language. Moreover, using a corpus can distinguish between spoken and written languages because both have different characteristics and distinctive linguistic features. Thus, by accessing and using a corpus or corpora, the students don't have to live in the target language environment to experience the actual use of English [20]. Considering the size, a corpus can also offer many examples for teachers and learners, later using them as parts of teaching materials or test items. Thus, the corpus size is one of the strengths of a corpus that we hardly find in any other teaching and learning resources.

Apart from the strengths of corpus, which provide some benefits for language teachers, there are some drawbacks of using corpus. Apart from the large-scale data provided by a corpus, it informs us whether the pattern has occurred and whether it is



frequent [24], [25], but it cannot inform us about what is possible and is not related to grammaticality or ungrammaticality. Regarding the application of corpus, the findings of corpus search or corpus activity should be adjusted to the needs of the learners and the course [20]. The results of corpus investigation or corpus consultation sometimes cannot be used directly due to the learners' proficiency level. It leads to the demand for another skill, which also needs extra effort from the teachers who use the corpus.

Furthermore, it is also important to consider the technical aspects of using the corpus. Since corpus is quite technical, to use it, teachers should be familiar with it. Some terms are new for language teachers, especially if they do not have strong knowledge of linguistics. These terms, such as *concordance*, *collocation*, *KWIC*, *PoS Tag*, *collocation span*, *n-gram*, and others, are pretty much confusing for new users of a corpus. Besides, we should have a good Internet connection to smoothly access the corpus, which can be a constraint for some teachers and students in remote areas.

## Conclusion

As a tool to help teach and learn English, corpus offers many benefits. As a teaching and learning media and resource, corpus can be accessed and used directly in the classroom to assist both teachers and learners in getting quality language input. Teachers should highly consider this activity because the intuition of a non-native speaker of English is not a reliable source. In the Society 5.0 era, the Internet is tremendously faster, and big data continues to be very useful and prominent in various aspects of life, including language teaching. If there is a huge source of English language data we can use and consult, how can we just ignore it? We can make use of corpus and take some benefits. With regard to notable benefits of corpus, it can be the best companion to the existing textbooks used by teachers. However, corpus applications should be equipped with sufficient training, which means corpus-related courses should be taught in the teaching department. Good internet connection should also be provided for more comfortable teaching and learning sessions.

## References

- [1] I. McGrath, *Teaching Materials and the Roles of EFL/ESL Teachers: Practice and Theory*. London: Bloomsbury, 2013.
- [2] U. Römer, "A Corpus-Driven Approach to Modal Auxiliaries and their Didactics," in *How to Use Corpora in Language Teaching*, J.

- M. Sinclair, Ed. Amsterdam: John Benjamin Publishing Company, 2004.
- [3] J. Mukundan and L. Khojasteh, "Modal Auxiliary Verbs in Prescribed Malaysian English Textbooks," *ELT*, vol. 4, no. 1, p. 79, Feb. 2011, doi: 10.5539/elt.v4n1p79.
  - [4] I. N. Oktavianti and J. Sarage, "Collocates of 'great' and 'good' in the Corpus of Contemporary American English and Indonesian EFL Textbooks," *SiELE*, vol. 8, no. 2, pp. 457–478, May 2021, doi: 10.24815/siele.v8i2.18594.
  - [5] J. Holmes, "Doubt and Certainty in ESL Textbooks," *Applied Linguistics*, vol. 9, no. 1, pp. 21–44, Mar. 1988, doi: 10.1093/applin/9.1.21.
  - [6] D. Shin and Y. V. Chon, "A Corpus-based Analysis of Curriculum-based Elementary and Secondary English Textbooks," *Multimedia-Assisted Language Learning*, vol. 14, no. 1, pp. 145–179, Apr. 2011, doi: 10.15702/MALL.2011.14.1.145.
  - [7] A. Molavi, M. Koosha, and H. Hosseini, "A Comparative Corpus-Based Analysis of Lexical Collocations Used in EFL textbooks," *LACLIL*, vol. 7, no. 1, pp. 66–81, Apr. 2014, doi: 10.5294/lacil.2014.7.1.4.
  - [8] I. N. Oktavianti and A. Fajria, "Modal Verbs in a Curriculum-Based EFL Textbook of Senior High School in Indonesia: A Corpus-Based Study," *TESOL International Journal*, vol. 16, no. 5, pp. 171–204, 2021.
  - [9] I. N. Oktavianti, I. Prayogi, M. A. Amal B., and R. S. Pertiwi, "An Analysis of Conversations in Curriculum-based EFL Textbooks for Senior High School in Indonesia and the Comparison with Corpus-based English Textbooks," *Universal Journal of Educational Research*, vol. 8, no. 9, pp. 4151–4162, Sep. 2020, doi: 10.13189/ujer.2020.080941.
  - [10] A. Gilmore, "A Comparison of Textbook and Authentic Interactions," *ELT Journal*, vol. 58, no. 4, pp. 363–374, Oct. 2004, doi: 10.1093/elt/58.4.363.
  - [11] J. Hurwitz, A. Nugent, F. Halper, and M. Kaufman, *Big Data for Dummies*. New Jersey: John Wiley & Sons, Inc., 2013.
  - [12] M. Kitsuregawa, "Transformational Role of Big Data in Society 5.0," in *2018 IEEE International Conference on Big Data (Big Data)*, Seattle, WA, USA, Dec. 2018, pp. 3–3. doi: 10.1109/BigData.2018.8621989.
  - [13] A. Burkette and W. A. Kretzschmar Jr., *Exploring Linguistic Science: Language Use, Complexity, and Interaction*, 1st ed.

- Cambridge University Press, 2018. doi: 10.1017/9781108344326.
- [14] I. Timmis, *Corpus Linguistics for ELT*, 0 ed. London: Routledge, 2015. doi: 10.4324/9781315715537.
- [15] A. O'Keeffe, M. McCarthy, and R. Carter, *From Corpus to Classroom: Language Use and Language Teaching*. Cambridge: Cambridge University Press, 2007.
- [16] U. Römer, "Using General and Specialized Corpora in English Language Teaching: Past, Present and Future," in *Corpus-Based Approaches to English Language Teaching*, M. C. Campoy, M. L. Gea-Valor, and B. Belles-Fortuño, Eds. London: Continuum, 2010.
- [17] T. McEnery and A. Hardie, *Corpus Linguistics*. Cambridge: Cambridge University Press, 2012.
- [18] W. Crawford and E. Csomay, *Doing Corpus Linguistics*, 0 ed. Routledge, 2015. doi: 10.4324/9781315775647.
- [19] P. Szudarski, *Corpus Linguistics for Vocabulary: A Guide for Research*, 1st ed. London: Routledge, 2017. doi: 10.4324/9781315107769.
- [20] M. McCarthy, *Touchstone: From Corpus to Course Book*. New York: Cambridge University Press, 2004.
- [21] A. Boulton, "What Data for Data-Driven Learning?" *Eurocall*, vol. 20, no. 1, p. 36, Mar. 2012, doi: 10.4995/eurocall.2012.16038.
- [22] P. Liu, "Data-Driven ESP Vocabulary Learning," in *International Conference on Modern Education and Social Science*, 2016, pp. 219–225.
- [23] S. I. Nugraha, F. Miftakh, and K. Wachyudi, "Teaching Grammar through Data-Driven Learning (DDL) Approach," presented at the Ninth International Conference on Applied Linguistics (CONAPLIN 9), Bandung, Indonesia, 2017. doi: 10.2991/conaplin-16.2017.68.
- [24] S. Hunston, *Corpora in Applied Linguistics*. Cambridge: Cambridge University Press, 2002.
- [25] L. Flowerdew, *Corpora and Language Education*. London: Palgrave Macmillan UK, 2012. doi: 10.1057/9780230355569.

# **Analysis of Leadership Style and Work Environment: The effect on employee Job Satisfaction**

Irwan Idrus<sup>59</sup>, Jumriani, Mutia Mursidiq Hasan

## **Introduction**

Human Resource Management is one of the key factors to get the best performance. In addition to handling skills and expertise, Human Resources Management also obliged to build conducive behavior for employees to get the best performance. Competitive pressures in the business world require companies to think about how the company adapts to an ever-changing environment.

Employee job satisfaction is beneficial for improving employee performance, dedication, and discipline, because job satisfaction is a pleasant emotional attitude at work, this attitude can be reflected by work morale, discipline, and work performance. The attitude of job dissatisfaction will be able to result in decreased productivity, discipline of employees, which in turn disrupts the running of the company as a whole.

Every employee who works in a company certainly really wants the maximum level of job satisfaction. In order to achieve the maximum level of job satisfaction in every task implementation, you will always face factors that are expected to affect job satisfaction. Job satisfaction is measured using five indicators, namely; 1) Satisfaction with promotion, 2) Satisfaction with co-workers, 3) Satisfaction with salary, 4) Satisfaction with the work itself, 5) Satisfaction with the attitude of superiors.

Job satisfaction are determined of few factors, one of the factors is leadership style. Job satisfaction refers to how content an individual is with his or her job in an organization. It has been used as a mean to allure and retain the qualified and performance employees in the organization. An organizational can achieve of mission and goals by effective leadership style of the leaders. It can be achieved by capable of providing motivational stimulus and direction to the followers by the leaders of organization [4].

Judging from the job satisfaction indicators, the situation at PT PLN (The state electricity company) of Parepare is very supportive in terms of co-workers who look quite harmonious and make

---

<sup>59</sup> Universitas Muhammadiyah Parepare

employees feel comfortable and get satisfaction at work. Employees help each other if there are difficulties at work. In terms of rewards or salaries, employees feel enough with the salary given because it is in accordance with what they do. In terms of the work itself, job satisfaction decreases because there are too many demands in the job. Judging from the attitude of the boss, there are so many demands on the work that must be done so that employees feel pressured and feel dissatisfied with their work, especially in certain fields.

Several studies state that leader behavior is one of the important factors that can affect job satisfaction. The leadership style has four indicators, namely: carrying out tasks, providing support, prioritizing results over process, and giving instructions.

The objective of this research is to analysis the effect of leaderships style and work environment on employee job satisfaction. This research was conducted at PT PLN Parepare using quantitative descriptive analysis. The method used is quantitative method with data collection techniques used, namely observation, questionnaires and interviews. This research was conducted by giving questionnaires to all employees of PT PLN Parepare, totaling 50 employees.

## **Discussion**

### **Effect of Leadership Style on Employee Job Satisfaction**

Leadership style is the way in which a leader carries out his duties and responsibilities as a leader. Leaders have a role to direct and motivate employees to work well so that company goals can be achieved effectively and efficiently.

The application of leadership style at PT PLN of Parepare based on the results of research shows that the leadership in the company has been able to provide solutions to every problem faced by its employees.

Leaders must have the ability to find solutions to all the problems and obstacles faced in the work process, because a leader must be a person who is able to find a way out of the obstacles faced by employees and their teams.

Leaders at PT PLN of Parepare based on the results of observations and employee questionnaires indicate that leaders have good abilities in providing direction to employees.

A good leader must understand the company's goals and have a strategy to achieve these goals. The strategy that is owned must of course be passed down to all employees in a way that the leader must provide good direction to employees so that employees are able to

work on implementing the established strategy in order to achieve common goals.

In addition to providing direction to employees, the leadership at PT PLN of Parepare also has the task of supervising the performance of its employees. This is done to ensure that all employees have worked in accordance with their directions and company regulations so that the achievement of goals can be monitored.

The leadership at PT PLN of Parepare also evaluates employee performance on a regular basis to see whether the performance produced by the employee is in accordance with the company's goals. When performance is not in accordance with company goals, corrective action is taken so that in subsequent performance employees can correct their shortcomings and improve their performance.

The results of the evaluation carried out by the leadership at PT PLN of Parepare will produce directions for employees who have less performance to improve it, the directions are given clearly so that employees are able to immediately take corrective action so that performance can be improved in order to achieve company goals.

This is supported by the analysis of research data which shows that the results of SPSS Sig = 0.003 < = 0.05 so that Ho is rejected and Ha is accepted so that it is stated that there is a partially significant influence between leadership style on employee job satisfaction of PT PLN of Parepare.

This means that the better the leadership style applied to PT PLN of Parepare, the better employee satisfaction will be so that the company's goals can be achieved in accordance with the provisions that have been set.

This is in line with the results of data analysis of the partial correlation between leadership style variables and satisfaction, which obtained an r value of 0.716. This value indicates a strong positive relationship between leadership style and employee job satisfaction. The strong positive meaning here is that there is a unidirectional relationship between leadership style and employee job satisfaction.

This is in line with previous research by [7], which stated that leadership has a positive and significant effect on employee performance.

In line with research revealed by [11] that leadership style and work environment have a positive and significant influence on job satisfaction at PT. Pos (Persero) Manado.

### **Effect of Work Environment on Employee Job Satisfaction**

The work environment is one of the factors that support employee work activities, the work environment can provide comfort to employees so as to increase morale, but the work environment can also reduce employee morale.

Every company certainly expects a good work environment so that it can support employee work activities which in turn can provide benefits to improving employee performance.

The work environment at PT PLN of Parepare based on observations in research shows that all employees respect each other so as to create good relationships between fellow employees. This good relationship creates a conducive work environment and the spirit of helping to achieve better performance.

The work environment of PT PLN of Parepare which respects each other creates a habit of helping each other. The habit of helping each other among employees has an impact on the ease of carrying out work because when an employee experiences difficulties, other employees do not hesitate to provide assistance in completing work.

In addition to a work environment that respects fellow employees and a sense of mutual help, it is equally important to build an atmosphere of intimacy with fellow employees. Based on observations at PT PLN of Parepare, it was stated that an atmosphere of intimacy between employees and leaders has been created in the work environment of PT PLN of Parepare. This creates a conducive working atmosphere so as to increase employee morale which in turn can improve performance.

The work environment also important especially in terms of room layout that is able to provide a comfortable view for employees to improve their performance. The atmosphere of the layout of the room and its contents at PT PLN of Parepare can be said to be good because it is able to provide comfort to employees in their daily activities.

A cool room temperature is also one of the factors that determine whether a company's work environment can provide comfort for employees at work. Based on observations at the time of the study, it was explained that the cool room temperature at PT PLN of Parepare made all employees comfortable so that it increased enthusiasm in doing their respective tasks.

This is supported by the analysis of research data which shows that the results of SPSS are  $\text{Sig} = 0.001 < = 0.05$  so that  $H_0$  is rejected and  $H_a$  is accepted so that it is stated that there is a partially

significant effect between the work environment on the job satisfaction of PT PLN of Parepare employees.

This means that the better the work environment applied to PT PLN of Parepare, the better the employee's performance will be so that the company's goals can be achieved in accordance with the provisions that have been set.

This is in line with the results of data analysis of the partial correlation between work environment variables and job satisfaction, the  $r$  value of 0.729 is obtained. This value shows a strong positive relationship between work environment and employee job satisfaction. The strong positive meaning here is that there is a unidirectional relationship between the work environment and employee job satisfaction.

The influence given by the variables of leadership style and work environment on employee job satisfaction is 60%. This means that the variables of leadership style and work environment contribute to the influence of 60% on employee job satisfaction at PT PLN of Parepare, while the remaining 40% is influenced by other variables not included in the study.

This is in line with [8] which states that the work environment has a significant and positive effect on job satisfaction at PT. Hyup Sung Indonesia, Purbalingga.

### **Effect of Leadership Style and Work Environment on Employee Job Satisfaction**

Based on the results of data analysis shows that simultaneously the application of leadership style and work environment affect the level of job satisfaction of employees at PT PLN of Parepare. Good leadership will certainly have an impact on employee job satisfaction because employees will feel comfortable with the leader in the office.

Meanwhile, simultaneously the work environment also has an influence on the job satisfaction of PT PLN of Parepare employees because with a comfortable work environment, employees will carry out their duties and work comfortably so that it will increase job satisfaction.

This is in accordance with the results of data analysis which shows that based on the  $F$  test (simultaneous test) the  $F_{count} = 36,399$ , while using the  $F$  distribution table, the  $F_{table} = 3.20$ , which means  $F_{count} > F_{table}$ , it can be concluded that there is a simultaneous significant effect between leadership styles. and work



environment on the level of job satisfaction of PT PLN of Parepare employees, while the remaining 40% is influenced by other variables not included in the study.

Based on the model summary table, it can be explained that the simultaneous correlation between leadership style and work environment on employee job satisfaction obtained a value of 0.780. This value shows a strong positive relationship simultaneously or simultaneously between the variables of leadership style and work environment on employee performance.

The strong positive meaning here is that there is a unidirectional relationship between the variables of leadership style and work environment on employee job satisfaction. This means that if the value of the two independent variables increases together, then employee job satisfaction will also increase.

## **Conclusion**

Based on the results of the research, it can be concluded as follows:

1. Leadership style has a positive and significant effect on employee job satisfaction of PT PLN of Parepare.
2. The work environment has a positive and significant effect on employee job satisfaction of PT PLN of Parepare.
3. Leadership style and work environment have a simultaneous and positive and significant effect on employee job satisfaction of PT PLN of Parepare

## **References**

- [1] Cholid Narbuko dan Abu Achmadi, *Metodologi Penelitian*, Jakarta: PT.Bumi Aksara, 2013
- [2] DS Rafiie, N Azis, S Idris - *Jurnal Magister Manajemen*, 2018 - *e-repository.unsyiah.ac.id*
- [3] Judge.TA, & Locke. EA 1993. Effect of Dysfunctional Thouthth Process on Subjectibe well – Being and Job Satisfaction. *Journal of Applied Psychology*.
- [4] Lok, P., & Crawford, J. (2004). The effect of organisational culture and leadership style on job satisfaction and organisational commitment: A cross-national comparison. *Journal of Management Development*, 23(4), 321–338. <https://doi.org/10.1108/02621710410529785/FULL/XML>
- [5] Nawawi, Hadari. 2003. *Manajemen Sumber Daya Manusia Untuk Bisnis Yang Kompetitif*. Yogyakarta: Gajah Mada University Press.

- [6] Nasution, N. 2010. *Manajemen Mutu Terpadu*. Bogor : Ghali Indonesia
- [7] Ode, W., Muizu, Z., Kaltum, U., Sule, E. T., Kepemimpinan, P., & Karyawan, K. (2019). Pengaruh Kepemimpinan terhadap Kinerja Karyawan. *PERWIRA - Jurnal Pendidikan Kewirausahaan Indonesia*, 2(1), 70–78. <https://perwiraindonesia.com/eJournal/index.php/perwira/article/view/13>
- [8] Purnomo, A. (2014). Pengaruh Motivasi Kerja dan lingkungan kerja terhadap Kepuasan Kerja pada Karyawan PT. *Hyup Sung Indonesia Purbalingga. Proposal. Yogyakarta. Fakultas Ekonomi Universitas Negeri Yogyakarta*.
- [9] Putra, NK Sariyathi - *Jurnal Manajemen Universitas Udayana*, 2015 - [ojs.unud.ac.id](http://ojs.unud.ac.id)
- [10] D Human, [A Yuniawan](#)- *Diponegoro Journal of Management*, 2016 - [ejournal3.undip.ac.id](http://ejournal3.undip.ac.id)
- [11] Plangiten, P., Kepemimpinan, G., & Lingkungan..., D. (2013). Gaya Kepemimpinan Dan Lingkungan Kerja Pengaruhnya Terhadap Kepuasan Kerja Karyawan Pada PT. Pos Indonesia (Persero) Manado. *Jurnal EMBA : Jurnal Riset Ekonomi, Manajemen, Bisnis Dan Akuntansi*, 1(4), 2155–2166. <https://doi.org/10.35794/EMBA.1.4.2013.3426>
- [12] Robbins, S. P., & Judge, T. A. (2011). *Organizational Behavior ( 14th Edition ) 14th Edition*. 9780136124016, 1–5.

# The Architecture of *Banua tada* Buton, Southeast Sulawesi and its Challenges in the Future

Ishak Kadir, M. Husni Kotta

## Introduction

In Kakawin Negarakartagama (1365), the name Buton is mentioned, which is called hand in hand with Banggawi, who already has a social and political order. Besides Buton, Wolio's name is also attached to the same royal name. Wolio is a related name in the framework of settlement formation. The Sipanjonga group's landing on Buton Island was divided into two groups: the group led by Sipanjonga and Simaluni in Kalampa, while the group led by Sitamanajo and Sijawangkati in Walalogusi. They are considered the founding figures of the Wolio community, which is traditionally known as *mia patamiana* (literally means the four people). The first group, led by Sipanjonga and Sijawangkati, built a new settlement on the beach in Kalampa, while Simalui and Sitamanajo built a settlement in Walalogusi. The two groups later regrouped in Kalampa, but their village was often disturbed by security from pirates [1], [2].

The initial village which was the landing site was then abandoned by its inhabitants, moving to a higher and safer place. This move was made to avoid pirate attacks that often attack coastal areas in Sulawesi waters, especially Southeast Sulawesi. The new settlement that was built was known as *welia* (Wolio: cutting bushes). After carrying out various pioneering projects which took almost 30 years, the kingdom, which was named *Wolio* (from the word *welia* meaning pioneer), was proclaimed, as well as the inauguration of Ratu Wa Kaa Kaa in the field in 1332 AD on the island of Buton. The Bandar Wolio Kingdom is increasingly crowded with trading boats that are sometimes boarded by figures who spread Islam. Sheikh Abdul Wahid who came from the country of Johor anchored at Rampea beach in the Bungarasi area. After reporting himself to Raja Mulae, Raja Mulae spontaneously embraced Islam, which was followed by the royal family and high-ranking royals, and the people [1], [3].

Baubau City was formerly the center of the Buton (Wolio) Kingdom/Sultanate, founded in the early 15th century (1401–1499). The city was initially centered in the palace complex, located in the Sultanate of Buton, known as the ruler of almost the entire region of Southeast Sulawesi. All the coastal towns that developed in the area were under his dominion. The palace as the center of power lays the

foundation for a strong power structure and encourages the formation of settlements for residents who live around the court. Baubau City is one of the heritage cities in Indonesia that stores various cultural heritages based on historical and natural traces that are still preserved today. The beautiful nature of the coast, the wealth of unique cultural arts and various ancient objects, buildings, and places where historical events occurred during the Kingdom/Sultanate of Buton, including the largest fort in the world, as well as the *Banua tada* Buton stilt house which became the residence of most Butonese people at that time [4].

In its development, the existence of the Buton *banua tada* house has quite a big challenge in the future amid the development of science, technology, and human civilization today. The *banua tada* house has undergone many shifts in form, function, and space value in the buton *banu tada* space arrangement. This phenomenon does not only occur in *banua tada* Buton houses in Baubau urban area but also in rural areas in Southeast Sulawesi. This shift will gradually erode the cultural identity of Butonese in their dwellings. The culture that is formed is sometimes an accumulation of crystallized historical superimpositions.

Transformation in the context of architecture is to make changes and or adjustments to some of the physical elements of an original architectural object. Transformation of traditional architecture is the process of making changes and adjustments that include the shape or the external appearance of the architecture based on the conventional thinking process so that the final result can still be seen from the visual traces of the tradition that are used as a source of change, the process of which goes through the stages of compiling a visual statement related to the conceptual that will be used, evaluate and choose the ideas that are most relevant to the design object, carry out transformations with various methods of changing shape, convey information in the form of statements and visuals so that they can be accepted by outsiders [5], [6].

## **Discussion**

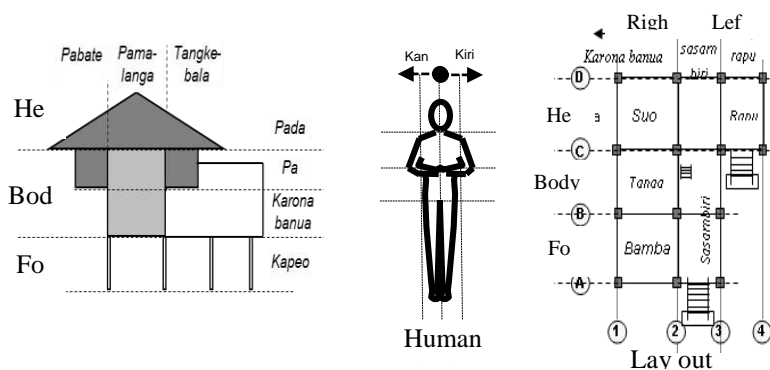
### **The architecture of *Banua tada* Buton**

Koedus explained [7], that the traditional Butonese house had existed since the time of the kings before Islam entered Buton. During the 4th Sultan of Buton, Laelangi, the traditional Buton house was adapted to the views of Islamic law. The basic concept of the traditional house of the Butonese is a legacy from the time of Sultan

Laelangi. His existence is maintained as cultural sustainability of the Butonese community from generation to generation. The architecture of the Buton house is called "*banu tada*" because there is an elbow (*tada*) on the pillar of the house which is the embodiment of the four conditions of harmony and brotherhood in the philosophy of life of the Butonese people, namely *pomaa-masiaka* (loving each other), *popia-piara* (mutual care), *pomae -maeaka* (advising each other), *poangka-angkataka* (mutual respect). There are three kinds of architectural building forms of *Banua tada* Buton based on a social level in society, namely: (1) *Banuatada* with *kambero* form for sultanate officials; (2) *Banua tada* for the *walaka* group (ordinary people), and (3) *Kamali* or *Malige*, the home for the *kaomu* (nobles) group. *Kamali* is the residence of the Sultan, and *Malige* is the residence of the nobility with a two-tiered roof, Andjo in [8], [9].

### The Basic Concept of the Buton House

The basic concept of the Buton house is a reflection of the cosmos or part of the microcosm which is expressed in the form of the building with a head, body, and feet or in other words the architecture of *Banua tada* Buton reflects humans as God's most perfect creatures of all creatures on this earth and the human elements symbolize the world and everything in it (Figure 1).



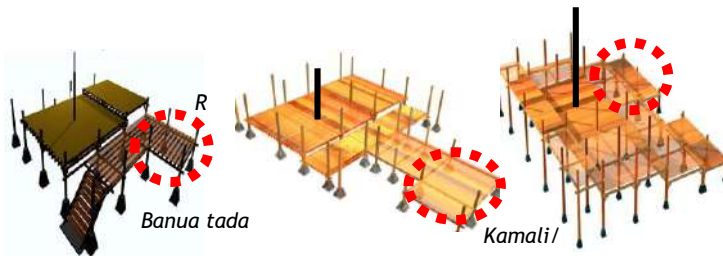
**Figure 1. Basic Concepts of architecture *banua tada***

The configuration of the *Banua tada* Buton room consists of three parts, namely: *bamba* (front room), *tanga* (middle room), and *suo* (back room). For the Butonese, a house is incomplete if it only

consists of two parts, because the house takes the example of the human body where the backroom (*suo*) is likened to the human head. Therefore, the floor structure of the *suo* room is made higher than the other rooms. Vertically the building of the house also takes the example of the human body, namely: the *kapeo* (under the house), the *corona banua* (the body of the house), and the *pada* (roof) as the legs, body, and head [9], [10], [11].

### The arrangement of Space of the *Banua tada Buton*

Symbolically the arrangement of spaces in the *Banua tada Buton* house visualizes the shape of the human body. The *bamba* space is expressed as the feet, the hand space is expressed as the body, and the *suo* space is expressed as the head. Vertically the building of the house also takes the example of the human body, namely: the paper (under the house), the *corona banua* (the body of the house), and the *pada* (roof) as the legs, body, and head (Figure 1). Based on the symbolic meaning, the arrangement of the spaces in the house, namely the *bamba* room is a male symbol, the *tanga* room is a female symbol, and the *suo* room is a symbol of husband and wife. The *pa* (attic) floor is a symbol for girls. The three rooms function in every ritual activity (*haroa*) in the house, namely the *bamba* room where men sit, the *tanga* room where women sit, and the *suo* room for religious ritual activities such as the marriage ceremony procession and the *pa* room for *posuo* activities. seclusion) for girls, namely the transition from adolescence (*kabua-bua*) to adulthood (*kalambe*) (Figure 2). All *haroa* activities related to women are carried out in the hand room. Clear boundaries between men's rooms and women's rooms are always found in the configuration of space in the house, and this separation is the meaning of practicing Islamic religious values [9], [10], [11].



**Figure 2.** The arrangement of the space at the

Furthermore, [8] stated that the *bamba*, *tanga*, and *suo* rooms are core components that tend to be continuous and difficult to change, while changes only occur on the outside the side (*sasambiri*), to the front of the terrace (*kaompu*) and the lower room of the house (*kapeo*). Cosmologically, the hierarchical value of space in the *Banua tada* Buton house recognizes the concept of Left and Right of the house, namely the right side of the house is a sacred space area where the arrangement of the *bamba*, *tanga*, and *suo* spaces is found. On the left side of the house is an unholy space area. There is an arrangement of the *sasambiri*, *rapu* (Figure 2). This right-left hierarchical concept is found in the dwellings of the Buton Wolio community, both in the *kamali/malige* building and in the dwellings of ordinary people, so that the location of the kitchen is always found on the left [9], [10], [11].

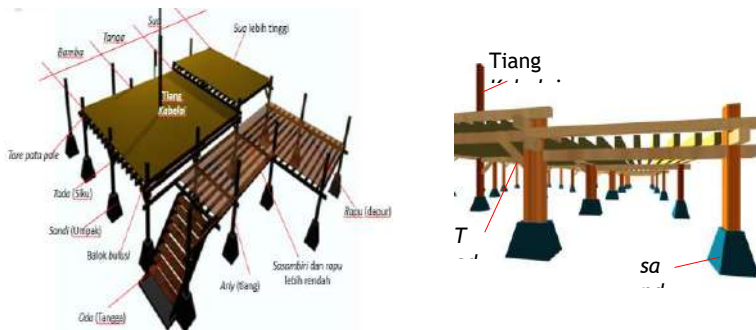
There are differences in the placement of the kitchen located in the *Banua tada* Buton house in the coastal area. The seaside community of Sulaa believes that any activity related to physical activities such as fishing must pass through the stairs or the kitchen door. The location of the stairs or kitchen door is always on the right. This difference is the uniqueness of the *Banua tada* residence for the Buton people, especially those who live in the coastal settlement area of Sulaa Baubau [10].

The shift in the value of space in *banua tada* is influenced by changes in the function and physical form of the area. Changes in the function of space occur due to the addition of the number of family members or changes in the type of activity in the house. These changes include the living room on the *bamba* that functions as a bedroom. The *bamba* room is used as a place for family economic business activities. Changes in space arrangement also occur due to a shift in the occupants' perception who assume that there is no more sacred space so that all areas have the same value. In the concept of a space hierarchy, the right-left concept in the *banua tada* house is no longer considered so that all spaces are deemed to have the same space value.

### ***Banua tada* Buton House Building Structure Buton House Mast Structure**

The poles are made of selected wood such as *biti* wood, *bayam* wood, and *jati* wood. *Banua tada* with *tada kambero* form uses 16 poles. On each pole, there is a *tada* (elbow) as a reinforcement for the pole's construction and has a symbolic meaning. It is called *tada kambero* (fan) because the center pole has two *tada* on both sides,

which resembles a fan's shape. Houses with *tada kambero* are reserved for the nobility (*kaomu*) or the walaka group who served in the Buton Sultanate with a minimum position of *siolimbona* (Sultanate Council) (Figure 3).



**Figure 3. Buton House Mast**

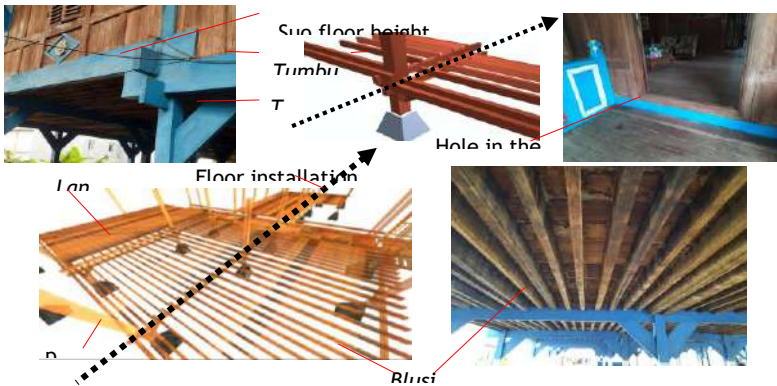
Based on the social status of the occupants, the pillar structure of the house is divided into 3, namely *Kamali*, *banua tada tare pata pale*, and *banua tada tare talu pale*. *Kamali* is the residence of the sultan and his family. *Banua tada tare pata pale* which means a four-posted elbow house is a house where officials or palace employees live. Meanwhile, *banua tada tare talu pale* which means a three-posted house is a house where ordinary people live with round pillars (Figure 3). The symbolic meaning of the round pillar in the *banua tada* house of ordinary people is that the community must accept the Sultan's decision unanimously, while the rectangular pillar in the *banua tada* house of the nobility and *Kamali* is interpreted that the sultan thinks about many sides. Between the poles, there is the main pole (*ariy belai*) which is located on the second/middle pole in the second row of poles. At the lower end of the pole, there is an foundation stone (*sandi*) [9], [10], [11].

### Floor Structure

The surface structure on the floor of the Buton house has a different level of height between one room and another. The unevenness of the surface of the floors reflects the characteristic nature of humans who have an up and down breath. So that between one space and another is stopped with the rhythm of the ups and downs of human breath. The floor made of teak wood on the *Kamali*/*Malige* symbolizes the sultan's social status as royalty and



represents the sultan's personality, who is always calm in dealing with problems. At the same time, the floor material used in other communities is bamboo which is split or uses wooden boards. The hole made in the floor is intended for bathing the corpse, which means always asking for death. The different holes on the floor also have different meanings, namely as a foot mat to purify oneself (Figure 4).



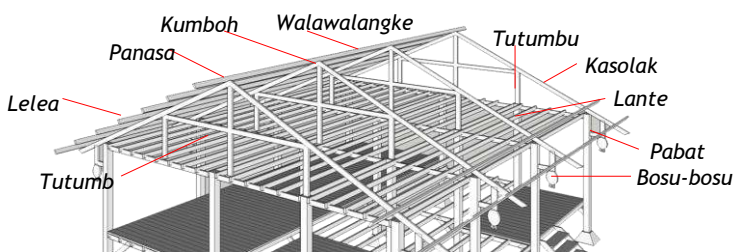
**Figure 4. Floor structure on the**

The floor structure of the house consists of (a) *tumbu tada* beams, and *konta* beams installed lengthwise backward parallel to the body of the house, which functions as a binder between the posts and mounts on top of the contact beams. While the *Konta* beam is located at the bottom which functions as a binder for a row of poles and a place for the *tada* to rest. (b) *blusi* beams are installed lengthwise backward parallel to the *tada* beams, which function as floor supports and fasteners between the posts. The distance between the *blusi* beams was taken from the distance of the human foot. (c) *Tananda* and *Kantaburi* beams, installed at the ends of the poles parallel to the row of poles that function as pole fasteners and a place for wall installation (Figure 4). The *kantaburi* beam is installed at the bottom parallel to the marking beam and functions as a *polanda kana rindi* beam (supported by a wall) [9], [10], [11]. In several cases of the *banu tada* house of the Buton people, the floor structure is made flat, and there is no longer any height difference based on the spatial hierarchy.

### House Roof Structure

The roof structure of the *banu tada* Buton house consists of (a) *tutumbu* pillars are poles that support the roof and are equal in value

to the main pole; namely, when the pole is raised, a traditional ceremony must be carried out. *Tutumbu* poles during the Buton sultanate used long beams whose ends touched the ground. (b) The *kasolaki* beam consists of two left and suitable beams resting on a *tutumbu* which supports a catfish beam and a *kumbohu* (ridge) is made at the top end (Figure 5). The roofs of *banua tada kambero* and *banua tada* are usually saddle-shaped and not stacked like the shape of a kamali or malige roof. The roofing material is thatch [9], [10], [11].



**Figure 5. Roof Structure on the *banua tada***

#### *Pabate/Tangkebala*

*Pabate/Tangkebala* is an element of the *banua tada* house in the form of a box or triangle on the upper side of the left and right walls of the house. *Pabate* functioned as a place to store goods or weave for women who have a wide *pabate*. *Pabate* on kamali becomes a symbol of the responsibility of a Sultan as a protector of society so that its size is more comprehensive than ordinary people's houses (Figure 6). The square-shaped *pabate* is used in the homes of the *kaomu* and *walaka* officials of the sultanate. In contrast, the triangular *pabate* is used in the houses of ordinary people [9], [10], [11].



Box shape pabate on Kamali

Bosu-bosu

Triangular shape

**Figure 6. *Pabate* on the *banua tada***

### Stairs (*Oda*)

Stairs are elements of a *banua tada* house that are used to go up and down from the house. The location of the stairs of the house is based on the social status of the occupants. The position of the ladder perpendicular to the stab is used in noble residences, which have a terrace (*kaompu*) and are equipped with a roof and stair railing.



Figure 7. The position of stairs on the

The number of stairs is odd 15 or 17, depending on the height of the house. The ladder's position is also used in ordinary people's homes but does not have a *kaompu* with an odd number of steps of 5 or 7. The ladder's position sideways and resting on the *kaompu* is only used in houses of the noble class (Figure 7).

### Home Decoration

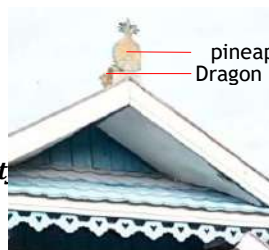
The decorative forms in the Buton house architecture are classified based on the decoration's value, motif, and location. Based on the matter, the ornament has an artistic value related to the beauty of the house and a spiritual value related to the meaning revealed behind the decorative symbol. Based on the motif, the ornamental variety consists of floral motifs in fruits such as pineapples and pomegranates. In contrast, the fauna motif is in the form of a dragon. Based on its location, the ornamental variety of pomegranate is located at the end of the *bosu-bosu* pole on the *pabate/tangkebala* which describes the personality as the pomegranate has a round shape, many seeds and colorful but still one color (Figure 8). The taste is sweet, astringent, and bitter, describing disagreements that can be overcome with awareness and a feeling of sharing the same fate [9], [10], [11].



pineappl



Dragon



pineappl  
Dragon

decoration at the end of

Pineapple is a symbol of a plant that can live anywhere, tenacious in the face of all challenges. Pineapple decorations are located at the ends of the front and rear ridge roofs. Behind the pineapple, there is a dragon decoration. This decoration is related to the belief that the dragon is placed on top of the roof because the dragon's abode is in the sky. The dragon is also associated with the origin of the ancestors of the Butonese, who came from China. In several cases of the *banu tada* Buton house, decorative ornaments are no longer found that give the characteristics of the *banu tada* Buton house.

### ***Banua tada* House Construction Process and Ceremony**

The process and traditional ceremonies in the construction of the *banua tada* Buton house are divided into three stages: the ceremony before building the house, the ceremony when building the house, and the ceremony after building the house. The stage in the ceremony before making a home is to determine the location of the house construction through family deliberation. Next, collect ingredients for building materials based on the direction of a knitting expert in determining auspicious days. *Sombuana banua* ceremony is a procession of building a house, namely the ceremony of punching the first pillar, which is the main casting (*ariy kabelai*) tied to the *yimpo*. The *sombuana banua* ceremony is led by the *pedempuu*. Next is the *banguana banua* ceremony (to build a building). The time of this ceremony is in the early hours of the morning which family, relatives, and neighbors attend. The whole process of building houses is carried out by the community based on the residents' *possasagu* (unity, alliance) values. After the construction of the *banua tada* house is complete, the next traditional ceremony is *limbasiana banua* (entering a new house) [9], [10], [11]. In general, Butonese people still carry out house construction ceremonies, but there are cases where the construction of *banua tada* houses is no longer carried out in its entirety.

### **Conclusion**

The architecture of *banua tada* Buton with symbolic meaning; all elements of the *banua tada* Buton house have a high definition and reflect the cosmos or part of the microcosm expressed in the shape of

the building with the head, body, and feet. The architecture of *banua tada* Buton reflects humans as God's most perfect creatures of all creatures on this earth, and the human elements symbolize the world and everything in it. The architecture of *banua tada* Buton embodies the four requirements of harmony and brotherhood in the philosophy of life of the Buton people. In its development, the *banua tada* Buton house has quite a tough challenge in the future and increasingly advanced science and technology development. However, the existence of a latent understanding of the Butonese community related to the *banu tada* concept will maintain the presence of the traditional *banua tada* Buton architecture as the cultural identity of the Butonese people in Southeast Sulawesi today and forever.

## References

- [1] Rabani, L., *Kota-Kota Pantai di Sulawesi Tenggara*. Ombak, Yogyakarta, 2010.
- [2] Zuhdi, S., *Sejarah Buton Yang Terabaikan Labu Rope Labu Wana*. Rajawali Pers PT. Raja Grafindo Persada, Jakarta, 2010.
- [3] Abubakar, L., *Bhinci-bhinciki Kuli*. Majalah Budaya Buton Wolio Molagi, Edisi Perdana Maret 1999, Yayasan Wolio Molagi, Kendari, pp. 33-35, 1999.
- [4] Kadir, I., Umar, M., Z., Hasan, L., O., Penerapan Konsep Arsitektur Lokal 'Banuatada' Dalam Permukiman Masyarakat Baubau. *Prosiding Seminar Nasional Jelajah Arsitektur Tradisional 2017 Menerapkan Kemanfaatan Pengetahuan Lokal dan Arsitektur Tradisional Untuk Permukiman Masa Kini dan Masa Mendatang*, Balai Litbang Perumahan Wilayah I Medan, Medan, pp.191-200, 2017.
- [5] Safitri, R. M. N., *Transformasi Arsitektur Monumen Batas Kota dalam Perancangan Mixed-Use Building sebagai Gateway Kota Yogyakarta Bagian Barat di Kawasan Gamping*. 2011. <https://dspace.uui.ac.id/handle/123456789/10349>, 2018
- [6] Susilo, G., Transformasi Bentuk Arsitektur Jawa. *Spectra*, XIII(25), pp.13-26, 2015.
- [7] Kadir, I., Ma'ruf, A., Hasan, L., O., 2016. Keberlanjutan Rumah Banuatada Buton di Sulaa Baubau. *Prosiding Seminar Nasional The Lost World* SCAN#7: 2016, Program Studi Arsitektur Fakultas Teknik, Universitas Atma Jaya, Yogyakarta, pp.II.62-II.70, 2016.
- [8] Kadir, I., *Kesinambungan dan Perubahan Pada Perkembangan Rumah Tradisional Buton di Kawasan Benteng Kraton Buton*

- Kabupaten Buton Sulawesi Tenggara*. Tesis S2, Program Studi Teknik Arsitektur, Universitas Gadjah Mada, Yogyakarta, 2000.
- [9] Kadir, I., Djunaedi, A. Sudaryono, Wibisono, B.H., Simbol pada Elemen Rumah Tradisional Buton di Permukiman Pesisir Sulaa Kota Baubau, *Prosiding Seminar Nasional Reinterpretasi Identitas Arsitektur Nusantara*, Jurusan Arsitektur Fakultas Teknik Universitas Udayana, Denpasar, pp.2.47-2.54, 2013.
- [10] Kadir, I., Djunaedi, A. Sudaryono, Wibisono, B.H., Nilai-nilai Budaya dan Bangunan Arsitektur Lokal Dalam Penciptaan dan Penggunaan Ruang di Permukiman Sulaa Baubau Sulawesi Tenggara. *Prosiding Seminar Nasional finding the fifth element after water, earth, wind, and fire*, SCAN#6: 2015, Program Studi Arsitektur Fakultas Teknik, Universitas Atma Jaya, Yogyakarta, pp.133-141, 2015.
- [11] Ramadan, S., *Kesultanan dan Aparatnya dalam Rumah Bangsawan Buton*. Tesis S2, Program studi Teknik Arsitektur, Universitas Gadjah Mada, Yogyakarta, 2003.

# **Coping Strategy for the Defense of Persons with Disabilities During the Covid-19 Pandemic**

Islamiyatur Rokhmah<sup>60</sup>

## **Introduction**

The Covid-19 pandemic has an impact on economic, social, health, etc. deteriorating for all levels of society, not least for people with disabilities, they are a group of people who have limitations that can hinder their participation and role in life and society. The number of people with disabilities in Indonesia is 6,008,661 people. The level of welfare of persons with disabilities/disabled persons during the COVID-19 pandemic has decreased drastically, this has greatly impacted the income and employment of persons with disabilities. The survey conducted by the Indonesian Disability Network Rapid Assessment of 1600 respondents with disabilities 86% experienced a decrease in income. [1] Kompas conducted an open research in the "Quick Assessment Report on the Impact of Covid-19 for Persons with Disabilities in 2020" on 1,683 respondents in 32 provinces in Indonesia, that the biggest obstacle for people with disabilities during the Covid-19 pandemic was the difficulty of mobility, even though they have skills, but still have difficulty accessing various activities. [2]

WHO states that people with disabilities are the group with the highest level of vulnerability to being infected with Covid-19. This condition is caused by the burden of implementing health protocols such as washing hands with soap which is physically inaccessible, making it difficult for them to do so. On the other hand, social services are not yet accessible for persons with disabilities during the COVID-19 pandemic. [3]

In a study conducted by Farasa DA [4] explained that the impact of the covid-19 pandemic for people with disabilities included difficulties in protecting themselves and meeting daily needs, people with disabilities were also at risk of being more susceptible to being infected with the Covid-19 virus, health conditions could deteriorate and even to death. Moreover, those who live in institutions will be more susceptible to being affected by viral infections and have higher mortality rates, more vulnerable to discrimination in accessing health services and safety procedures during the Covid-19 outbreak, and

---

<sup>60</sup> UNISA Yogyakarta

disadvantaged by the socio-economic consequences as a result of Covid-19 and countermeasures affecting work, social protection, education and other support services, and violence. As for people with visual impairments, they are vulnerable to contracting COVID-19 because they have difficulty in vision which is very vulnerable when they hold goods/objects or talk to other people who turn out to be Covid-19 sufferers and this also has an impact on the health of people with visual impairments.

Meanwhile, from an economic perspective, people with disabilities on average work in the informal sector, for example selling, massage therapy, and other informal sector jobs, which have decreased because their customers do not dare or use the services of people with disabilities and this is coupled with social restrictions in a number of areas. Meanwhile, to conduct electronic transactions also has its own obstacles for persons with disabilities. As for some jobs, with the Covid-19 pandemic, many have laid off their employees and can cause an increase in poverty. [4] Seeing the condition of people with disabilities who experience social vulnerability due to the COVID-19 pandemic, a self-defense mechanism is very much needed. So spiritual coping is very much needed by people with disabilities in dealing with pandemic situations.

## **Discussion**

Coping which comes from the word "cope" means opponent or overcome. While coping behavior according to Moser (1998) in his writings Badrun [5] is a person's ability to overcome the problems that surround his life. While Sarafino [7] and Chaplin (2006) in Badrun [5] coping is the process of individual behavior in managing stress or pressure in a certain way, for example by interacting with the environment to solve the problem, it can also be behavior in the form of conscious thoughts. used in dealing with stressful and stressful situations and demands.

Flokman and Lazarus in Sarafino [6] explained that in general the forms of coping behavior are divided into two classifications, namely: a. Problem Focused Coping (PFC) is a form of coping that is more directed at efforts to reduce the demands of stressful situations. b. Emotion Focused Coping (EFC) is a form of coping that is directed to regulate emotional responses to stressful situations. Individuals can regulate their emotional responses with behavioral and cognitive approaches. Factors that influence coping behavior according to Mutadin (2002) in Badrun [5] include:



1. Physical health. Health is important, because in an effort to cope with individual pressure, it is required to exert a large amount of energy.
2. Positive beliefs or views. Beliefs become a very important psychological resource, such as belief in fate (external locus of control) which exerts individuals on the assessment of helplessness which will reduce coping abilities.
3. Problem solving skills. These skills include the ability to seek information, analyze situations, identify problems with the aim of generating alternative courses of action, then consider these alternatives in relation to the results to be achieved, and finally implement the plan by taking an appropriate action.
4. Social skills. These skills include the ability to communicate and behave in ways that are in accordance with the social values prevailing in society.
5. Social support. This support includes support for fulfilling the information and emotional needs of the individual provided by parents, other family members, relatives, friends, and the surrounding community.
6. These Support Materials include resources in the form of money, goods or services that can normally be purchased.

Research on spiritual coping for people with disabilities has been found, in general, there are many studies on psychological coping strategies from stress during the covid-19 pandemic, including research conducted by Moh.Muslim, (2020) on stress management during the covid-10 pandemic, in The study describes how stress during a pandemic and coping strategies in dealing with stress during a pandemic for society in general. Then the research conducted by Badrun Susantyo [5] which is about mapping the coping strategies of Beneficiary Families (KPM) for the Family Hope Program (PKH) facing the Covid-19 outbreak, this qualitative research describes more quantitative data on coping with the economic survival of families who receive KPM assistance and PKH. On the other hand, research conducted by Casmini, [7] on the Meaning of the Spirituality of the Prophet's Hijrah in Problem Solving in the Covid-19 Pandemic Period, describes how to learn from the wisdom of the Prophet's hijrah who still has optimism in building a new civilization in Medina, the Covid-19 pandemic condition can implemented in the face of situations that have no clear end. Ukhrowi readiness is a worldly skill to be optimistic in facing the covid-19 pandemic.

## Conclulsion

It is important for Persons with Disabilities to have spiritual coping during this pandemic for survival, apart from being optimistic in facing the COVID-19 pandemic. In accordance with the writings of Mutadin and Casmini that in this pandemic situation apart from having strong physical health, you must have a positive view of the end of this pandemic, have skills in communication to overcome problems and most importantly social support.

## References

- [1] I. S. & J. Yulianto, Yang Bergerak dan yang Terpapar dimasa Pandemi, Suara Disabilitas Indoneisa, Jaringan DPOs Respon Covid-19 Inklusif, 2020.
- [2] Kompas, [Bebas.kompas.id/baca/riset/2020/06/ppotret-disabilitas-dimsa-pandemi](https://www.kompas.id/baca/riset/2020/06/ppotret-disabilitas-dimsa-pandemi).diakses pada 28 Sepetember 2021 pukul 11.30, Kompas, 2021.
- [3] V. S. d. Radiess, "PemenuhanKebutuhan Dasar Penyandang Disabilitas Pada Masa Pandemi Covid-19," PemenuhanKebutuhan Dasar Jurnal Pekerja Sosial, vol. Vol 3 No 1, pp. 61-69, Juli 2020, hal 61-69.
- [4] F. D. Aulia, "Peran Pemerintah Dalam Penangan Dampak Pandemi Coiv-19 bagi Penyandang Diabilitas," Fara Dhania Aulia Dkk, Peran Pemerintah Dalam Penangan Dampak Pandem Jurnal Pengabdian dan Penelitian kepada Masyarakat (JPPM), pp. 31-41, 2020.
- [5] B. Susanto, Pemetaan Strategis Coping keluarga Penerima Manfaat Program Keluarga Harapan Menghadapi Wabah Covid-19 di Kota Bogor, Depok, Bekasi dan Tangerang Selatan, P3KS, 2020.
- [6] Sarafino, Healthy Psychology: Biopsychosocial Interactions, USA: John Wiley dan Sons, 1998, edisi ke 3.
- [7] Casmini, "Casmini, Memaknai Spiritualitas Hijrah Rasulullah dalam problem Solving di Masa Pandemi Covid-19, Jurnal Bimbingan dan Konseling Islam, Vol 10, No1 Juni 2020," Jurnal Bimbingan dan Konseling Islam, vol. Vol 10 No 1, 2020.

# Prophets' Parenting Strategy Applied in the new Normal

Kana Safrina Rouzi<sup>61</sup>

## Introduction

After the emergency response period for the COVID-19 pandemic ended, the government implemented a New Normal policy that forces us to live together with the Covid-19 virus but must be able to keep ourselves from contagion. New Normal Life, which is now termed as "Adaptation of New Normal" which returns people who work from home during the emergency response to return working as usual. However, this does not apply to students who continue to study from home. This is an interesting phenomenon, namely the PJJ (Distance Learning or Learning From Home) phenomenon which will continue to be implemented indefinitely. When children are not in school and have to study online at home, this needs to be addressed so that the concentration of parents working in the office is not disturbed. This is where the challenge is because parents have to prepare physically and mentally in the face of changes in the way of working and learning that uses technology features in educating and requires its own strategy in parenting. As a psychotherapist, Nancy Colier, LCSW, says that technology not only makes life easier but also creates new problems and difficulties [1].

Family Education which is often called parenting, greatly determines the nature, character, and character of children [2]. Islam views the role of the family through parenting as very important, especially in instilling the values of Islamic teachings contained in the Qur'an and As-Sunnah. The family has an effective role in the emotional growth of children and the fulfillment of the needs for security, respect, religion, independence, attention, warmth, and passion [3]. The best strategy for Islamic education used by families, especially during the New Normal, is dialogue with family members so that all family members can control emotions, such as love, pride, anger and fear whose control comes from the Qur'an and Hadith.

The family function during this pandemic is very significant in overcoming the boredom that occurs due to quarantine/staying at

---

<sup>61</sup> Universitas Alma Ata Yogyakarta, [kanasafrina@almaata.ac.id](mailto:kanasafrina@almaata.ac.id)

home imposed by the government to break the chain of transmission of COVID-19. Quarantine could be a utterly annoying experience for parents to stability personal life, paintings and worrying for youths left at domestic with out a distinct resources. This state of affairs locations parents at a far better probability of experiencing strain and also the dearth of facilitate those kids come up of at a tough time may be the aim for the mental symptoms [4]. This quarantine period also tests the patience of parents in accompanying children in all activities including children's online learning [5]. The results of the study by S. J. Lee, et al (2021) suggest that the parent's mental health may be an important factor associated with home education and child well-being during the pandemic [6].

In this pandemic situation, it is hoped that family functions can be carried out properly to maximize harmonious relationships due to delays in communication so far and lack of satisfaction in the parent-child relationship which causes children to become addicted to drugs and addicted to gadgets [7]. So now is the time for parents to be expected to have a parenting strategy that is in accordance with Islamic teachings and this paper examines the parenting strategies of the prophets contained in the Qur'an.

## **Discussion**

### **Parenting According to the Psychology Context**

The focus of the contemporary psychological theory is the visible world, which includes parents and other family members. One of the weaknesses is the refusal to acknowledge the most important source of information about humans the revelation from Allah SWT. Psychoanalysis, which is considered the first force in psychology, originally came from Freud's psychoanalysis, which sought to understand the depths of the human psyche combined with mind awareness to produce healthy personality individuals are organisms whose behavior is determined within humans themselves (internal factors/id) [8]. Behaviorism (the second psychological force) also views that when humans are born, basically humans do not bring any talent (neutral) [9]. Humans will develop based on the stimulus they receive from the surrounding environment. A good environment will produce good people and vice versa. The behaviorists deny the internal factors of individuals who are considered like white paper (tabula rasa), even though humans are born with their talents and potential which is called fitrah.

Humanistic flow is seen as a "third force" because it developed as a reaction to the flow of Psychoanalysis and Behaviorism which has reduced humans as machines or inferior creatures. If Psychoanalysis studies humans in a sick condition, then this humanistic school studies healthy humans [10]. Humanistic psychology is very concerned about the human dimension in dealing with the environment humanely with an emphasis on individual freedom to express opinions and make choices, values, personal responsibility, autonomy, goals and meaning. This school has the view that basically human potential is unlimited and even too optimistic about efforts to develop human resources, so that humans are seen as the sole determinant that is able to play God [11].

Humanistic and transpersonal psychology theories suggest the importance of mindfulness and mental health in parenting to foster positive attitudes and emotions in children [12]. Humanistic theory guides parents to be human by nurturing children with love and realizing that children have potential. Transpersonal psychology calls this potential a spiritual power that grows according to its nature. It combines two theoretical frameworks, the competency-based humanistic approach of positive parenting and the transactional stress and coping model, and emphasizes that positive parent-child interactions are an essential part of successful parenting. [13].

### **Prophet's Parenting in the Qur'an**

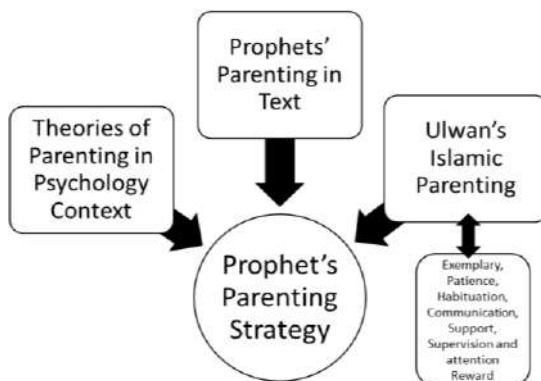
Positive parenting that involves sensitivity, responsiveness, caring, communication, and empowerment will ensure positive developmental outcomes in children and adolescents which serve as a promoter and preventive intervention for the mental health of children and adolescents, especially during this pandemic. [14]. Positive parenting that involves sensitivity, responsiveness, caring, communication, and empowerment will ensure positive developmental outcomes in children and adolescents which function as promote and preventive interventions for the mental health of children and adolescents that can cause positive emotions, especially during this pandemic. The method of communication is contained in the verses Hud: 42-43, Yusuf: 4-5, 11-14, 16-18, 63-67, 81-87, 94-98, 99-100, Maryam: 41-48, Al-Qashash: 26, Luqman: 13-19 and Ash-Shaffat: 99-111.

These verses describe the communication model between parents and children which is carried out using a persuasive approach. This persuasive approach is carried out for children to develop the

child's personality which includes faith, morals, physical, mental, spiritual and social which consists of 9 (nine) parenting materials which include: Aqidah, Morals, Worship, Social Life, Feelings, Physical, Intellectual, Health, and Sexual Ethics [15]. Parenting material for the prophets is believed to be able to restore the influence and function of parents who are starting to weaken at this time. The weakening is caused by social, cultural changes and especially technological changes and developments. This is intended to build extensive reciprocal communication accompanied by a warm attitude so as to produce positive development for children. A warm attitude in the family is believed to be able to overcome various problems in the family such as juvenile delinquency, drug addiction, gadget addiction, and so on.

### Prophets' Parenting Strategy in the New Normal Era

Through the study of children's education theory from Ulwan (1999) [16] and the *Maudhu'i* method [33] in the analysis of verses containing an interaction between parents and children carried out by Prophet Ibrahim and Prophet Ismail, Prophet Ya'kub and Prophet Yusuf, Prophet Nuh, Shaykh Madyan (Prophet Syuaib), Luqman and Maryam, then found parenting strategies in treating children, educate, guide and protect children from childhood to adulthood following values, norms, and culture with exemplary, patience, habituation, communication, support, supervision and attention, and reward [16] as seen below:



**Figure 1. Prophets' Parenting Strategy**

#### Exemplary

Exemplary is one of the most promising aspects of success in shaping a child's character (good faith and morals) with parent always

take care of the words and Everything that comes from parents is claimed as something that should be emulated. It is based on QS. Ash-Shaffat: 102, Al-Baqarah: 133, Yusuf: 5, 18, 65-68, 83-84, 94-98. These verses imply a deliberate example where the interactions that occur with their children make parents an important agent of socialization in environmental exploration. Exploration activities then bring the child into many different social objects. Through this interaction, children's competence in communication and role taking is expanded relevant to the social interactions that their children will face [17]. In this imitating behavior, children not only imitate what their parents do, but children also imitate what they think their parents have done after seeing the results of these actions. So children imitate what they see and imitate what they think others are doing based on signs of regularity or disorder [18].

Children are excellent imitators of every action and word. Children will not only follow the behavior of their parents but will also follow the mindset, views and values held by their parents. Therefore, when parents appear in front of their children, they should show affection and apply it in their daily life. Parenting by setting a good example, the child will get the main characteristics, perfect character, increase in virtue and honor [16]. Moral virtue manifested in good example is the most important factor in efforts to influence the heart and soul. This forms noble qualities, courage and might in carrying out Allah's commands.

## **Patience**

Patience is the greatest spiritual and moral virtue, which leads children to the peak of moral nobility. Patience is often referred to as the ability to delay gratification, holding back, refraining from complaining and grumbling, holding back the tongue from complaining, restraining the limbs from disturbing actions. According to the interpretation of Ash-Shaffat: 99-111 and Yusuf: 18, the essence of patience is perseverance in maintaining religious impulses in the face of lustful impulses. If religious impulses overcome lust, it has reached the level of patience [19]. Al-Ghazali [20] divides patience into four levels, First, be patient in obedience because obedience requires patience in three things; starting worship with sincerity and freeing oneself from *riya'* and satanic tricks, carrying out *fardhu* worship and its *sunnah*, and not to spread the *amaliyah*.

Second, patience from disobedience that has become a habitual character such as backbiting, lying, bickering and pride.

Third, be patient with things that are not related to the servant's efforts, and try to ward off and improve them. Fourth, be patient with events at the beginning and end, such as the death of a loved one, loss of property and various other calamities. All of that (obedience, disobedience and trials) is a picture of a life. Patience is an important concern if you want the goodness and moral improvement of children.

Patience implies steadfastness and submission to Allah SWT and the ability to control oneself (self-regulation) in the face of daily temptations and trials and try not to get angry quickly. The development of self-regulation and cognitive abilities (regulation, cognition, consciousness, biology) can also foster beliefs about self-concept positive in children [21].

### **Habituation**

Parenting through habituation makes all sorts of things easier. The role of habituation in children's growth and development will find pure monotheism. Habituation of worship and pious deeds taught by parents to train children to be responsible for the practice of amar ma'ruf nahi munkar [16]. Encouraging positive personal and social behaviors such as psychological adjustment and moral responsibility [18]. According to Ibn Kathir [17] said that the parenting of the prophets contained in the QS. Hud: 43 and QS. Luqman: 13-16 teaches parents to take care of their children through habituation to be responsible. Responsible for ensuring physical health and safety, preparing children to become independent adults in all aspects, and encouraging positive personal and social behaviors such as psychological adjustment and moral responsibility.

Children must be taught to behave well and stay away from evil bad habit otherwise the child's soul will be damaged. Ulwan further argues that parents must improve the children's customs before they pass puberty based on three main problems, namely: (a). Remind with aqidah, (b). Explain the reproach of the crime and (c). Change the social environment. The interaction between parents and children is reciprocal in supporting the growth and development of children's positive traits and habituation of positive behavior.

### **Communication**

Based on the study and analysis of the interpretation of Shihab [22] in the verses of QS. Ash-Shaffat: 102, Yusuf: 4-5, 11-14, 16-18, 63-67, 81-87, 94-98, 99-100, Al-Qashash: 26 dan 11, Luqman:



13-19 there is a communication method in the family which is a parent-child relationship to control actions and to reinforce parental authority. Parents must communicate about; (a). The basics of monotheism, (b). The basics of social life such as ukhuwwah, compassion, altruism, forgiveness, holding fast to the truth based on piety to Allah SWT, (c). The basics of ethics in various aspects of life, such as eating, drinking and speaking etiquette [16].

Consistent communication creates a collaborative family atmosphere that will strengthen children's growth and make children able to learn whatever their parents teach them. The collaborative is where parents create a culture of cooperation in the family and mutual response from the very beginning of the child's life. Sensitive parents provide care that meets the needs of the child [23]. This nurturing creates harmony in the parent-child relationship and results in a secure attachment. Safe attachment between parents and children results in children responding to gentle parenting as a logical thing, so parents in communicating rules do not need to apply coercive attitudes such as threats and spanking. Parents must be able to express warmth through words, tenderness of expression, and involvement in appreciating children's achievements [24]. So parents become a giver of love and a place to develop potential which is an element of education.

### **Support**

According to verse Yusuf: 11-13, Hamka [25] interprets that the parenting of the prophet Ya'qub involved a series of attitudes towards children to create an emotional climate in which parenting behavior was expressed. One of Baumbrind's parenting dimensions is the support that is considered to support psychosocial development, requests, or expectations that are applied to children's behavior [26]. Support is positively related to beliefs about the legitimacy of parental authority [27]. Parental support is related to the interaction between parents and their children in the context of deliberately participating in encouraging, discussing, and/or providing opportunities related to children's activities and children's independence. According to Social Learning theory, parental support relates to certain social behaviors in children (such as: smiling, praising, spending time together, entertaining, talking, etc.) [28]. Symbolic Interaction Theory explains that the relationship between parental support and socialization in children as a symbol of the child's values and competencies, such as trusted, competent, and effective [29]. Therefore, children who are

consistently nurtured and supported learn to become more confident in engaging with meaningful others in their social environment..

### **Supervision and Attention**

Al-Qur'ān verses Luqman: 17-18 and At-Tahrim: 6 ordered parents to pay attention and control their children in all aspects of life and universal education [25]. Parents as caregivers in mobilizing enthusiasm and increasing the ability to pay attention and supervise in order to prepare the Muslim generation. This aims to regulate behavior by setting demands and limits to enforce a regulatory structure, by setting rules and boundaries, and by monitoring children's behavior. This facilitates positive outcomes and acts as a safeguard against deviant behavior. Among the many attempts to operationalize the concept of supervision and attention, parents can control their children's behavior [30] [31]. Application of proportional supervision and attention in various fields, such as faith, spirituality, morals, knowledge, association with other people, mental, emotional, etc. Children will also be more solemn in fulfilling the rights of Allah SWT in muraqabah and worship [16].

### **Reward**

Good parenting needs to be rewarded. The reward can be in the form of rewards or punishments. This is stated in the letter Ash-Shafaat: 105-111, Huud: 71, Yusuf: 5, 63-65, 97-100, Al-Qashash: 24-26 in the form of rewards, but there are also in the form of punishment as described in the letter Huud: 43, Maryam: 46, Yusuf: 18, 64, 81, 84 [25].

In the context of parenting, punishment refers to the restraint of unpleasant non-physical behavior or deprivation of privilege, which is intended to suppress unwanted behavior or make the child obey the rules. These unpleasant behavioral restrictions are usually imposed to make children "think" so that they will heed the parent's message and act according to the parent's direction [12]. Children will have feelings and sensitivities that reject their lust to do things that are forbidden. Without this the child will continue to be in humiliation, evil and corruption. Therefore, if parents want goodness and happiness in their children, parents should be wise in giving rewards and punishments [32]. Giving this punishment is carried out with a gentle attitude, maintaining the right character of the child, correcting mistakes gradually by pointing out mistakes with direction, friendliness, cues, criticism and finally by breaking the relationship.

## Conclusion

The parenting strategy applied in this new normal requires parents to explore the Qur'an that contains prophets' parenting guidelines, namely: example, patience, habituation, communication, support, supervision and attention, and rewards. The prophets' Parenting as a guide in guiding and maintaining the growth of children is responsible and obliged to seek the children's development physically and spiritually healthy.

Life in this new normal era requires families to live in a world with various social media on gadgets and computers. Parenting can occur via WhatsApp, Facebook, Instagram, twitter, and so on which can be accessed via smartphones. Given the influence of using media, especially smartphones, which have become a necessity, parents need to take action to control the use of social media. Parents can make rules to reap the positive benefits of using media and reduce its negative impact on the development of social and emotional skills of children

## Reference

- [1] Juwairiyah, *Dasar-dasar Pendidikan Anak Dalam Al-Quran*. Yogyakarta: Teras, 2010.
- [2] Collier. N, *The power of off: the mindful way to stay sane in a virtual world*. Sounds True, 2016.
- [3] S. M. AL Zbon, A. M. O., & Smadi, "The role of the family in the emotional growth of the adolescent in light of the Islamic education," *Int. J. Adolesc. Youth*, vol. 22(1), pp. 78–92, 2017.
- [4] M. Spinelli, M., Lionetti, F., Pastore, M., & Fasolo, "Parents' Stress and Children's Psychological Problems in Families Facing the COVID-19 Outbreak in Italy," *Front. Psychol.*, vol. 11, p. 1713, 2020.
- [5] A. Tabi'in, "Problematika Stay At Home Pada Anak Usia Dini Di Tengah Pandemi Covid 19," *J. Golden Age, Univ. Hamzanwadi*, vol. Vol. 04, no. No. 1, pp. 190–200, 2020.
- [6] S. J. Lee, K. P. Ward, O. D. Chang, and K. M. Downing, "Parenting activities and the transition to home-based education during the COVID-19 pandemic," *Child. Youth Serv. Rev.*, vol. 122, 2021, doi: 10.1016/j.childyouth.2020.105585.
- [7] J. L. Corbett, "Parental Influence on Juvenile Delinquency," Youngstown State University, 2019.

- [8] S. Churchill and D. J. Reynolds, "Psychoanalysis and existential psychoanalysis," in *Jean-Paul Sartre*, 2020.
- [9] Hanna Djumhana Bastaman, *Integrasi Psikologi dengan Islam: Menuju Psikologi Islami*. Yogyakarta: Pustaka Pelajar, 2011.
- [10] Abdul Muhaya, *Psikologi Transpersonal Islam*. Semarang: RMP UIN Walisongo, 2015.
- [11] L. W. Fry, "Toward a theory of spiritual leadership," *Leadersh. Q.*, vol. 14, no. 6, 2003, doi: 10.1016/j.leaqua.2003.09.001.
- [12] Y. Effendi, "POLA ASUH ANAK DI TENGAH PANDEMI COVID-19: Pendekatan Humanistik dalam mendukung Tumbuh Kembang Anak," *Welf. J. Ilmu Kesejaht. Sos.*, vol. 9, no. 2, 2021, doi: 10.14421/welfare.2020.092-03.
- [13] M. Andrews, "Families Coping: Effective Strategies for You and Your Child," *Educ. Dev. Psychol.*, vol. 32, no. 1, 2015, doi: 10.1017/edp.2015.2.
- [14] U. Karki, G. Dhonju, and A. R. Kunwar, "Parenting during the COVID-19 pandemic," *J. Nepal Med. Assoc.*, vol. 58, no. 231, pp. 957–959, 2020, doi: 10.31729/jnma.5319.
- [15] Z. Drajat, "Ilmu Jiwa Agama," *Jakarta: Bulan Bintang*, 1996.
- [16] A. N. Ulwan, *Pendidikan Anak dalam Islam*. Jakarta: Pustaka Amani, 1999.
- [17] I. Kaşır, "Tafsir Ibnu Katsir." 2013.
- [18] J. Brooks, "The Process of Parenting," in *The Process of Parenting*, 2008.
- [19] S. Quṭb, *Tafsir fi Zilali al-Qur'an*. Jakarta: Gema Insani Press, 2000.
- [20] Ghazali, *Ihya Ulumuddin, juz III*. Beirut: Muassasah al-Hilby, 1967.
- [21] Subandi, "Sabar: Sebuah Konsep Psikologi," *J. Psikol.*, vol. 38, no. 2, 2015, doi: 10.22146/jpsi.7654.
- [22] M. Q. Shihab, *Tafsir Al-Misbah: pesan, kesan dan keserasian Al-Qur'an*. Ciputat: Penerbit Lentera Hati, 2011.
- [23] M. Helimäki, A. Laitila, and K. Kumpulainen, "'You helped me out of that darkness' Children as dialogical partners in the collaborative post-family therapy research interview," *J. Marital Fam. Ther.*, 2021, doi: 10.1111/jmft.12505.
- [24] E. Hulen, "What Is Natural Is Best: A Qualitative Exploration of Women's Engagement in Attachment Parenting," *J. Fam. Issues*, 2021, doi: 10.1177/0192513X21993885.
- [25] Hamka, *Tafsir Al-Azhar Juz I- XII*. Jakarta: PT. Pustaka Panjimas, 1988.
- [26] D. Baumrind, "Parenting styles and adolescent development," *Infanc. y Aprendiz.*, 1991.

- [27] C. Mellado, P. Cumsille, and M. L. Martínez, "Interactive associations of parental support, demands, and psychological control, over adolescents' beliefs about the legitimacy of parental authority," *J. Adolesc.*, vol. 64, 2018, doi: 10.1016/j.adolescence.2018.02.001.
- [28] John W. Santrock, *LIFE-SPAN Development (13th ed.)*. 2017.
- [29] N. L. Cole, "Symbolic Interaction Theory: History, Development, and Examples," *ThoughtCo*, 2020. .
- [30] M. Claes *et al.*, "Parental Control and Conflicts in Adolescence: A Cross-National Comparison of the United States, Canada, Mexico, France, and Italy," *J. Fam. Issues*, vol. 39, no. 16, 2018, doi: 10.1177/0192513X18800123.
- [31] H. H. M. Altarturi, M. Saadon, and N. B. Anuar, "Cyber parental control: A bibliometric study," *Child. Youth Serv. Rev.*, vol. 116, 2020, doi: 10.1016/j.chilyouth.2020.105134.
- [32] F. M. Suud, A. Gaffar, K. S. Rouzi, and M. T. Chaer, "The Role of Islamic Counselling in Pandemic COVID 19: A Conceptual Study for Developing Positive Emotion of Parents and Children," *KONSELING Reli. J. Bimbing. Konseling Islam*, 2020, doi: 10.21043/kr.v11i1.7705.
- [33] Y. Maladi, "Makna dan Manfaat Tafsir Maudhu'i," E. Zulaiha and M. T. Rahman, Eds. Bandung: Prodi S2 Studi Agama-Agama UIN Sunan Gunung Djati Bandung., 2021.

# **Interconnection between Students' Cognitive Obstacles and Cognitive Load Theory in the Era of Society 5.0**

Kartinah<sup>62</sup>

## **Introduction**

Problems about obstacles in the world of education will always exist and are likely to develop in line with changes that occur in society. The era that is currently taking place is what is called the era of society 5.0. The era of super smart society (society 5.0) in 2019 was introduced by the Japanese Government which was created as an anticipation of disruption due to the industrial revolution 4.0 which caused uncertainty, and it was feared that this invention would cause the erosion of human character values. In facing the era of society 5.0, the world of education plays an important role in improving the quality of Human Resources. In addition to education, several elements and stakeholders such as the government, educational institutions and the entire community must also play a role in welcoming the era of society 5.0. One of the basic ideas of the concept of society 5.0 is that it is hoped that artificial intelligence products will transform big data from internet transaction products in all areas of life into a new wisdom, namely creating hope to increase human abilities in opening new opportunities for humanity. Society 5.0 emerged as a development of the industrial revolution 4.0 which was considered to have the potential to degrade the role of humans themselves. In society 5.0, humans will be the center (human centered) by remaining technology-based. The Education Unit requires a change in the educational paradigm. Among other things, by minimizing the role of educators as learning material providers as has been going on for a long time, educators must be the inspiration that motivates students. In this case, it takes the ability to map all the obstacles experienced by students during learning inside and outside the classroom as early as possible so that solutions can be immediately found.

The obstacles have been studied by many researchers, including: [1], [2], [3], [4], [5], [6]. The term obstacle is defined as something that hinders the progress/achievement of something

---

<sup>62</sup> University of PGRI Semarang

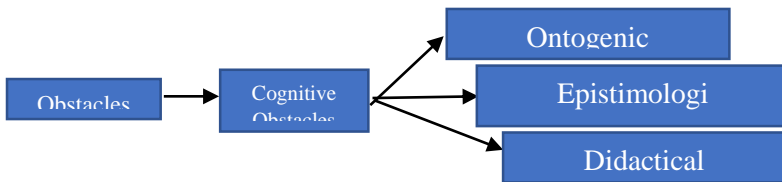
(Merriam Webster's online dictionary).[1] said that an obstacle is something that hinders student progress in learning. The idea of obstacles was first introduced in the world of science by [7] that barriers are part of students' knowledge at one time that are generally reliable in solving certain problems but this knowledge is then inadequate when faced with new problems. [7] find obstacles when students encounter limit determination is no longer a simple numerical and algebraic calculation. The student concluded implicitly that the limit process "goes on forever and the limit "can never be attained". Meanwhile [7], [2] argues that obstacles are something that arises as a result of tightly held beliefs about mathematics which are rarely easy to remove from the mind. [7] investigating the generic definition of limit that if all sequence patterns have certain properties, then it is reasonable to believe that limits also have the same properties. So the sequence 0.9, 0.99, 0.999, has a pattern that is entirely less than one, so the limit with "zero point nine repeated" must be less than one. Barriers are knowledge that a person has and is generally sufficient in solving a particular problem, stays in the mind, but then, when faced with a new problem, this knowledge is inadequate and difficult to adapt.

[8] argues for reason to believe that there are fundamental obstacles that arise from the fact that certain concepts have a level of complexity that makes it necessary to know them in a certain order. For example, fractions are more complicated than all numbers, students' experience with operations on integers leads to the implicit nature that "multiplication makes a number bigger", leading to a cognitive obstacle when individuals encounter multiplication of fractions less than one. However, some topics are taught in a particular order, perhaps not having the notion that one basic concept is more complex than another. For example, fractions are usually found in the current syllabus before negative numbers, but the reason why is not stated.

According to [3] there are four kinds of obstacles, namely epistemological barriers, cognitive barriers, genetic or ontogenic obstacles and didactic obstacles. Researchers have identified, classified and analyzed obstacles from historical, epistemological, and learning theory perspectives. History is important because mathematical concepts are the result of past developments. How knowledge is acquired is an epistemological obstacle and the main purpose of learning is to acquire knowledge [1]. Genetic barriers are also called ontogenic obstacles as a result of students' personal

development [5]. Didactic obstacles are obstacles that arise as a result of instructional choices and can therefore be avoided through the development of learning approaches [5]. Cognitive obstacles are a product of previous experiences and students' internal processes of these experiences and are manifested when students experience difficulties in the learning process, a tendency to rely on misleading intuitive experiences, and a tendency to generalize. [3], [1]. [9] states that cognitive impairment is a situation in which a student is confronted with mathematical content that contains known and unknown parts of the material content. Cognitive obstacles are ways of thinking about mathematical structures or objects that are appropriate in one situation but not in another [6].

Below is a chart of Obstacles according to Brousseau



**Chart 1. Obstacles by Brousseau**

Meanwhile, the recommended learning models for teachers as choices include Problem Based Learning (PBL), Discovery Learning and Project Based Learning (PjBL). These learning models include scientific method activities of observing, developing conjectures, taking data and drawing conclusions/generalizing and communicating what has been found. For teachers, the existence of these learning models is certainly very helpful, but for students it is necessary to pay attention to the cognitive load experienced. [10] explained that if in a lesson there are tasks that burden the student's cognitive system, it will cause a cognitive load on the student. Cognitive load is the amount of mental effort a person's memory makes to obtain information [10]. Cognitive load theory is a theory that explains the difference between a task and a person's ability to fulfill the task. Cognitive load theory is based on the principle of cognitive learning where the memory capacity of workers is limited, the capacity of long-term memory is unlimited (all material can be stored), the material stored in long-term memory is also called schema. A person or student can only process some material at a time in the worker's memory [11]. Therefore, a learning strategy that



optimizes the allocation of cognitive resources is important to determine the effectiveness of the learning. According to Cognitive Load Theory, cognitive load is caused by three interrelated sources, namely Extraneous Cognitive Load (ECL), Intrinsic Cognitive Load (ICL), and German Cognitive Load. (GCL) [12]. Extraneous Cognitive Load (ECL) is a cognitive load caused by cognitive processes relevant to being studied and the schema acquisition process. Many learning and problem solving methods force students to create cognitive load for students, namely cognitive loads that arise due to inappropriate teaching designs. Intrinsic Cognitive Load (ICL) is a cognitive load caused by the level of complexity of the information or material being studied. Extraneous Cognitive Load (ECL) is a cognitive load caused by cognitive processes relevant to being studied and the schema acquisition process. Many learning and problem solving methods force students to create cognitive load for students, namely cognitive loads that arise due to inappropriate teaching designs. Intrinsic Cognitive Load (ICL) is a cognitive load caused by the level of complexity of the information or material being studied. [13].

## **Discussion**

The challenges of the world of education are also affected by the changing era from industry 4.0 to the era of society 5.0. The industrial era 4.0 focuses more on the production process, while the era of society 5.0 places more emphasis on efforts to place humans as the center of innovation [14]. This is in line with the educational paradigm that makes students not as objects but as subjects. As the subject of education, students must be considered physically and mentally. Because in learning the emphasis is on brain activity, so this is in line with cognitive load theory which combines three elements proportionally so that learning objectives are achieved. Learning will be effective if  $ICL + ECL + GCL < \text{Worker memory capacity}$ . The cognitive load caused by the level of complexity of the material raises the intrinsic cognitive load is something that cannot be changed but can be managed by educators/teachers so as not to cause obstacles for students, one of which is by not giving assignments or materials to students simultaneously in large quantities in large quantities. one time. The cognitive load caused by the material presentation technique, namely ECL extraneous cognitive load, is the same as the ICL which involves elements of interactivity but these elements are completely under the control of teaching. This means that educators can really manage this element into something

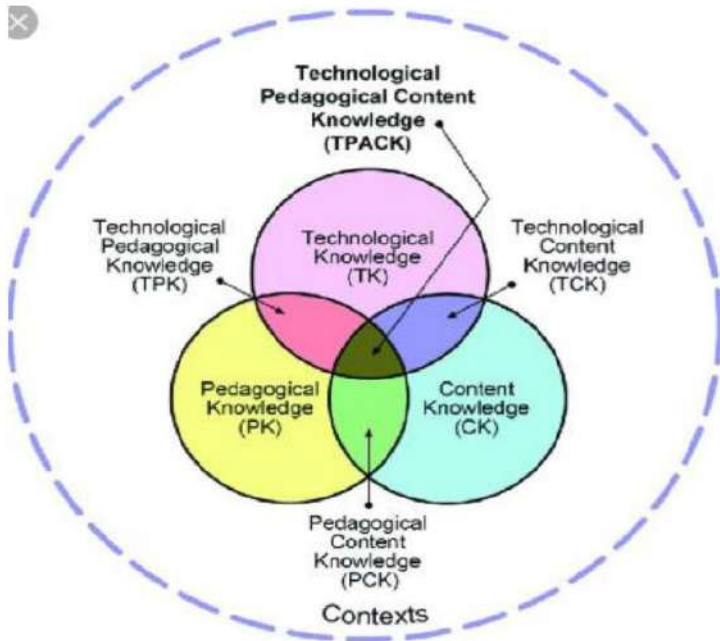
that is easier for students to live with. This can be done by utilizing technology-based learning media, both used in the classroom and outside the classroom. Many alternative technology-based media are flexible for students to learn outside the school environment, either at home or elsewhere. The last is the GCL german cognitive load where this cognitive load is caused by cognitive processes that are relevant to understanding the material being studied and the process of acquiring knowledge schemas.

### **The relationship between CLT and Cognitive Obstacles**

Cognitive obstacles experienced by students during the teaching and learning process are generally caused by three types, namely didactic obstacles (caused by learning), Epistemological obstacles (caused by difficult learning materials), and ontogenic obstacles (caused by students' cognitive abilities). Didactic barriers caused by teaching by teachers, can be minimized by efforts by teachers themselves in transforming knowledge using technology-based learning media, because as we know that teachers are required to master TPACK (Technological, Pedagogical, Content Knowledge), namely knowledge of digital technology, knowledge of learning processes and strategies, knowledge of the field of study or learning materials. If the knowledge of digital technology is explained, it is related to the teacher's ability to use available digital technology in learning. A teacher in the 21st century can or can not, is a necessity, should not stutter technology. This is in accordance with what is written in the theory of extraneous cognitive load EGL, the cognitive load caused by the technique of presenting material because there is a relationship between teaching design and knowledge acquisition. The second cognitive obstacle is epistemological obstacle, obstacles that occur about how learning material is obtained by students in relation to the level of difficulty of the material when it is associated with ICL where the cognitive load caused by the level of complexity of the information or material being studied because the higher the complexity of the task, the higher cognitive resources used. Finally, German cognitive load is a cognitive load involving elements of interactivity but these elements are completely under the control of teaching. This is where the teacher can play a role in reducing cognitive obstacles experienced by students, namely by managing the assignment of tasks not simultaneously at the same time, managing learning resources that students must learn, managing

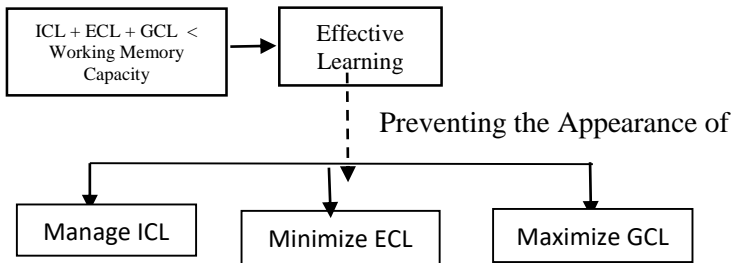
difficult material to become easier to understand with the help of learning media.

The following is the TPACK chart of the technology integration framework in learning.

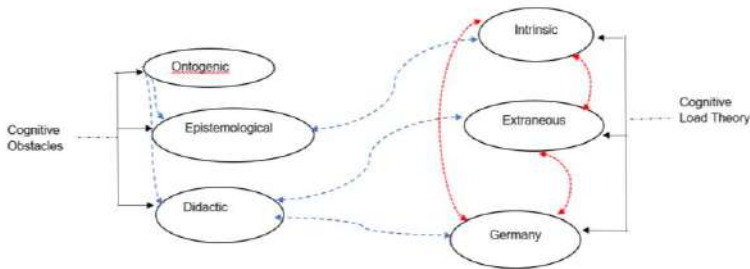


**Chart 2. TPACK framework for technology integration in learning**

In you 2 above it is seen that PCK, TPK, and TCK are generally accepted knowledge packages do not refer to the field of study or subject matter specifically so that it is a general framework. TPACK synthesizes teacher knowledge according to context, so that teachers can teach certain materials using learning technology to facilitate the learning process of learners. These three PCK, TPK, and TCK knowledge packages are one knowledge package that cannot be separated. Furthermore, chart 3 shows the steps for learning to run effectively associated with cognitive load theory.



**Chart 3. The steps for effective learning are linked to cognitive load theory.**



**Chart 4. The relationship between cognitive inhibition and cognitive load theory.**

### Conclusion

The era of society 5.0 focuses on positioning humans at the center of technological modification and innovation for the benefit of humanity. Humanize humans and humanize students. Learners as a human, have cognitive abilities at the same time can experience cognitive barriers. Cognitive abilities must be developed and maintained. While cognitive barriers must be found a way out so as not to interfere with the process of absorbing information/learning materials received by students. The ways that teachers can take are through cognitive load theory, minimizing extraneous cognitive loudness, managing intrinsic cognitive load, and maximizing german cognitive load.

### References

- [1] E. K. Moru, "Epistemological Obstacles in Coming to Understand

- the Limit Concept at Undergraduate Level : A Case of the National University of Lesotho," p. 232, 2006, [Online]. Available: <http://etd.uwc.ac.za/xmlui/handle/11394/1921>.
- [2] D. Tall, "The Psychology of Advanced Mathematical Thinking," *Adv. Math. Think.*, vol. 21, pp. 3–21, 2002, doi: 10.1007/0-306-47203-1\_1.
- [3] B. Cornu, "BCornu-Limites-Conceptions & Obstacles-Vol1," vol. 1, no. July, 2019.
- [4] A. Eraslan, "A qualitative study: Algebra honor students' cognitive obstacles as they explore concepts of quadratic functions," p. 193, 2005, [Online]. Available: <https://fsu.digital.flvc.org/islandora/object/fsu%3A168706/>.
- [5] M. R. Nyikahadzoyi, T. Mapuwei, and M. Chinyoka, "Some Cognitive Obstacles Faced By 'A' Level Mathematics Students in Understanding Inequalities: A Case Study of Bindura Urban High Schools," *Int. J. Acad. Res. Progress. Educ. Dev.*, vol. 2, no. 2, pp. 206–221, 2013.
- [6] J. Tague and G. Richard Baker, "Flipping the Classroom to Address Cognitive Obstacles Greg Baker in the mathematics department on instructional technology in a differential equations course for engineering students. Research interests include mathematical literacy for engineers and in," *121st ASEE Annu. Conf. Expo.*, 2014.
- [7] D. Tall, "New Cognitive Obstacles in a Technological Paradigm," vol. 92, pp. 87–92, 1989.
- [8] G. Brousseau, *Theory of Didactical Situations in Mathematics*. 2002.
- [9] R. Antonijević, "Cognitive activities in solving mathematical tasks: The role of a cognitive obstacle," *Eurasia J. Math. Sci. Technol. Educ.*, vol. 12, no. 9, pp. 2503–2515, 2016, doi: 10.12973/eurasia.2016.1306a.
- [10] J. Sweller and P. Chandler, "Why Some Material is Difficult to Learn," *Cogn. Instr.*, vol. 12, no. 3, pp. 185–233, 1994, doi: 10.1207/s1532690xci1203\_1.
- [11] R. Moreno, "Cognitive load theory: more food for thought," *Instr. Sci.*, vol. 38, no. 2, pp. 135–141, 2010, doi: 10.1007/s11251-009-9122-9.
- [12] S. Kalyuga, "Informing: A cognitive load perspective," *Informing Sci.*, vol. 14, no. 1, pp. 33–45, 2011, doi: 10.28945/1349.
- [13] Centre for Education Statistics and, "Cognitive load theory: Research that teachers really need to understand.," *Cent. Educ.*

*Strat. Eval.*, no. August, p. 12, 2017.

- [14] A. G. Pereira, T. M. Lima, and F. Charrua-santos, "Industry 4.0 and Society 5.0: Opportunities and Threats," *Int. J. Recent Technol. Eng.*, vol. 8, no. 5, pp. 3305–3308, 2020, doi: 10.35940/ijrte.d8764.018520.

# **From pandemics to business opportunities by young people: an opportunity and development**

Kristina Sedyastuti<sup>63</sup>

## **Introduction**

Young people in today's 5.0 society have a big role to play because they have mastered technology and are quick to adapt. Entrepreneurship for young people helps them develop new skills and experiences that drive business innovation and resilience. There is a young entrepreneur from Jakarta who has successfully overcome the challenges of COVID-19 by developing his culinary business. His business journey has inspired many young Indonesians in a recent ILO-supported event. [1], Together with their business partners, they bring together employees to discuss the situation and agree on what they should do to help young people develop new skills and experiences that drive innovation and resilience to do.

Youth entrepreneurship helps youth to develop new skills and experiences that promote innovation and resilience. Young entrepreneurs, as a result, are responsive to new opportunities and trends as well as be able to better adapt with the changing labour market, this is also the answer to the existence of a lot of competition related to the difficult economic situation during the pandemic. Research results show that 60% of young people state that online business does not have an impact on academics, in fact doing online business provides positive potential and energy for them [2]

On the other hand, Covid-19 also positively impacts Indonesian citizens in dealing with economic problems. The Covid-19 Pandemic condition has made many people do business indirectly, or "Ecommerce." According to its development from time to time, E-commerce has a definition that continues to expand. According to Bauum (1999) in Febriantoro (2018), E-commerce is a business process through electronic transactions, exchange of goods, services, and electronic information using dynamic technology and applications. Its purpose is to connect companies, consumers, and communities. Furthermore, according to Turban et al. (2000) in Febriantoro (2018), E-commerce can be through existing networks

---

<sup>63</sup> University of PGRI Kanjuruhan Malang

on computers, including the internet, to carry out the buying and selling process and exchange of products, services, and information. We are social, Hootsuite (2018) in Febriantoro (2018) records Indonesia that "... January 2018 internet users in Indonesia reached 132.7 million with a penetration rate of 50% (population 262 million)[3], Data on active social media users is 130 million while registered mobile phone users are 177.9 million or 67% of the total population. From this survey, it was also found that there are 120 million active social media users who access using mobile devices. The high level of internet usage is triggered by infrastructure development and the ease of getting a smartphone or handheld device.

Currently, the Covid-19 pandemic has had much impact on economic activity. According to Taufik & Ayuningtyas (2020), the Covid-19 pandemic has impacted conventional business activities but can increase online-based businesses. Online business is an industry that has the potential for the public to do during the Covid-19 pandemic. The trend with online shopping is currently booming in the community around the world (Situmeang 2018). In Situmeang's research (2018), online business has a positive and significant impact on increasing people's income. [7] According to Adam, this online business is an activity to create, manage and expand commercial relationships online, also stated that this pandemic period also increased the economic wheels of online business people. Based on this, technology is essential for people who want to start an online business [9].

The supporting factors and inhibitors as well as supporting strategy based on consumer behavior survey and research of the development of e-commerce adoption have been mapped into qualitative and quantitative SWOT analysis [3].

This study uses a descriptive qualitative method by conducting unstructured and informal observations and interviews, concluding as a result and discussion, that from these observations, changes in communication and social life between humans change in a fast time [5]. The results show that the creative industry digital technology in West Java has problems in determining the right innovation strategy [5]

## **Discussion**

Opportunity is a positive trend that is located in the external environment of the company, and if the opportunity is exploited by



the company, then the business opportunity has the potential to generate profit for the company on an ongoing basis. According to the great dictionary of Indonesian opportunity is an opportunity (wiggle room) both in concrete form and in abstract form. Whereas according to Hendro (2011:133) business opportunities come from an inspiration, idea, or opportunity that arises to be utilized for one's benefit either in daily life or in business. An opportunity in English is an opportunity that means one or more occasions arises from an event or moment. Source of Opportunity The source of opportunities or opportunities according to Hendro (2011: 135) comes from:

1. Self-Opportunities (hobbies, talents, knowledge, and education) are the most promising and high-risk sources of success, for the following reasons:
  - a. Because business is a protracted process that might span a lifetime, it must make those who participate happy and successful.
  - b. Because business requires a high level of consistency and devotion, the secret to success is to enjoy your work.
  - c. Business success is the accumulation of successes in overcoming failure after failure in order to achieve everything.
2. The environment can provide various chances and inspiration, for example:
  - a. Parental efforts, in daily interactions, parents must frequently mention the problems they experience in their businesses. When paired with educational background, hobbies, skills, and expertise, can provide entrepreneurial inspiration.
  - b. The home environment, which includes things like associations, neighbors, playmates, and so on.
  - c. Habits for getting to university, traveling, the campus environment, making friends on campus, and so on.
  - d. When visiting a cafe or any other location where inspiration and business chances can be found.
3. Changes that take place Changes in the environment, such as Global Changes, Environmental Changes, Changes in Government Regulations, Changes in Seasons, Changes in Lifestyle, Changes in Level of Needs, Healthier Lifestyles, Changes in level (heavy) higher work pressure, Changes in information and communication technology, such as advances in cellular phone technology and the internet, and changes in the growth rate of vehicle ow are all great opportunities that often arise in a business.

4. Consumers The voice of consumers is important because it often brings up new ideas in improving existing products and opportunities for those who will set up new businesses. Feedback from consumers that can inspire new opportunities such as: complaints from consumers, suggestions from consumers, special requests from consumers and potential customers, dreams dreamed by consumers about certain products or services, expectations from consumers for the products or services offered.
5. Other People's Ideas Usually come from consumers, ideas from other people (complaints about products or services submitted by friends), can provide ideas that open opportunities in creating business.
6. Information Obtained in meeting with other people we sometimes get new information. For those who hear it, the new information can be useful as a business opportunity because it is related to the knowledge and experience it has. However, for certain people the new information is not useful because it has nothing to do with knowledge and skills experience they have. This can distinguish why there are people who feel they have no chance compared to people who have opportunities.

### **Opportunity**

Based on the above study, a discussion material will be obtained where the link between business, pandemic, opportunities and the potential of young people is a part that needs to be criticized so that it can be more widely applied so that it will increase income levels even though at the beginning it is still of small value but with sincerity and loyalty in managing business will certainly generate greater value. According to Adam, this online business is an activity to create, manage and expand commercial relationships online, also stated that this pandemic period also increased the economic wheels of online business people. Based on this, technology is essential for people who want to start an online business [8],

Factors Business Opportunity success factors according to Hendro (2011:143) the success factors of business opportunities are as follows: (1) The opportunity meets the characteristics of good business opportunities (2) Starting from market test and trial such as: How much your product needs level in the market; How much continuity the product needs; Find out why people are reluctant to buy, use, and use your services or products (3) Follow and meet the needs of consumers (4) Follow the trend (trend) of market changes

(5) Can be continuously innovated and improved quality (6) The risk of failure is not great when it first starts (7) Is the best alternative to the opportunities available. [3]

The Covid-19 epidemic is currently having a significant influence on economic activities. The Covid-19 epidemic, according to Taufik & Ayuningtyas (2020), has had an influence on traditional business operations, but it has the potential to increase online-based businesses. The public has the opportunity to benefit from online business amid the Covid-19 pandemic [12]. The popularity of online shopping is rapidly exploding in communities all over the world, online business has a good and considerable impact on people's income. This online business is an activity that involves the creation, management, and expansion of economic partnerships over the internet. This epidemic period also expanded the economic wheels of internet business individuals. As a result, anyone who want to start an internet business must have access to technology.

### **Negatif Impact**

Since the outbreak of the corona virus or known as the covid-19 pandemic, there has been a very significant decline in the turnover of MSME players. There are several MSME business sectors that are most affected, namely accommodation, tourism and food and beverage providers, wholesale and retail trade, and bicycle repair. motorcycles and transportation and trade [12]. Here we need the role of young people to rise up and get involved in MSME scale business and it is not impossible to turn into a fast growing business. because these young people and millennials have the ability to quickly adapt to changes and have the ability to innovate.

Another important impact is that some panic among consumers and companies has distorted usual consumption patterns and created market anomalies. Global financial markets have also been responsive to changes and global stock indexes have fallen [13]

### **Conclusion**

An online business also does not require large capital, especially an online shop business, because the basis for doing business online is the internet, students or young people who understand technology can do business online. According to Ilham (2018), many students take advantage of technological developments by doing online business. This is because online business is relatively easy and does not take time, so students can do

it anytime with the internet. So with various findings and previous research results, it is proven that young people play a positive role in the national economy, both in the pandemic era and in the post-pandemic Covid-19 era.

In turn, young entrepreneurs can take advantage of opportunities by building permanent businesses not only in online business, innovating, and building networks and using digital marketing to introduce products and also increase product sales, create products and services that are different from competitors, manage finances and planning. as well as analyze well and maintain the quality of the products they offer to the public.

## References

- [1] N. S. Putri, "The influence of the Covid-19 Pandemic on young online businesses," *Indones. J. Soc. Sci.*, vol. 13, no. 1, p. 1, 2021, doi: 10.20473/ijss.v13i1.26349.
- [2] S. F. Aruni and R. Hidayat, "Psikologi Peluang Kewirausahaan: Proses Kognitif Pengusaha Startup Digital dalam Opportunity Recognition," *Jurnal Psikologi*, vol. 46, no. 1. p. 45, 2019, doi: 10.22146/jpsi.34608.
- [3] W. Febriantoro, "Kajian Dan Strategi Pendukung Perkembangan E-Commerce Bagi Umkm Di Indonesia," *J. MANAJERIAL*, vol. 17, no. 2, p. 184, 2018, doi: 10.17509/manajerial.v17i2.10441.
- [4] A. Susilo *et al.*, "Coronavirus Disease 2019: Tinjauan Literatur Terkini Coronavirus Disease 2019: Review of Current Literatures," *J. Penyakit Dalam Indones.*, vol. 7, no. 1, pp. 45–67, 2020.
- [5] E. M. Hasibuan and M. Yusram, "Hukum Salat Berjamaah Di Masjid Dengan Saf Terpisah Karena Wabah Covid-19," *Bid. Huk. Islam*, vol. 1, no. 2, pp. 106–124, 2020, doi: 10.1093/trstmh/traa025.1.
- [6] J. A. Dani and Y. Mediantara, "Covid-19 Dan Perubahan Komunikasi Sosial," *Persepsi*, vol. 3, no. 1, pp. 94–102, 2020, doi: 10.30596/persepsi.v3i1.4510.
- [7] S. Shabrina, "Memperkuat Kesadaran Bela Negara Di Tengah Pandemi COVID-19 (Strengthening the Awareness to Defend the Country in the Middle of the COVID-19)," *SSRN Electron. J.*, vol. 19, 2020, doi: 10.2139/ssrn.3576300.
- [8] A. Setiawan Rifqi, "Lembar Kegiatan Literasi Sainifik untuk Pembelajaran Jarak Jauh Topik Penyakit Coronavirus 2019 (COVID-19)," *J. Ilmu Pendidik*, vol. 2, no. 1, pp.28–37, 2020.

- [9] E. Subroto, "Pengantar Studi Semantik dan Pragmatik." Cakrawala Media, Surakarta, 2011.
- [10] Sudaryanto, *Metode dan Aneka Teknik Analisis Bahasa*, 1st, Septemb ed. Yogyakarta: Sanata Dharma University Press, 2015.
- [11] D. E. Subroto, *Pengantar Metode Linguistik Struktural*, Pertama. Surakarta: UNS Press, 1992.
- [12] T. Taufik and E. A. Ayuningtyas, "Dampak Pandemi Covid 19 Terhadap Bisnis Dan Eksistensi Platform Online," *J. Pengemb. Wiraswasta*, vol. 22, no. 01, p. 21, 2020, doi: 10.33370/jpw.v22i01.389.
- [13] W. McKibben and R. Fernando, "Centre for Applied Macroeconomic Analysis The Global Macroeconomic Impacts of COVID-19: Seven Scenarios," *Cent. Appl. Macroecon. Anal.*, pp. 1-45, 2020, [Online]. Available: [https://cama.crawford.anu.edu.au/sites/default/files/publication/cama\\_crawford\\_anu\\_e\\_du\\_au/2020-03/19\\_2020\\_mckibbin\\_fernando\\_0.pdf](https://cama.crawford.anu.edu.au/sites/default/files/publication/cama_crawford_anu_e_du_au/2020-03/19_2020_mckibbin_fernando_0.pdf).

## **Characteristics Of Lactic Acid Bacteria In Feces Of Mongoose (*Paradoxurus Hermaphroditus*) In District Jember**

Kukuh Munandar<sup>64</sup>

### **Introduction**

Mongoose coffee is a product of coffee beans which have been swallowed by mongoose and through its digestive tract. Mongoose (*Paradoxurus hermaphroditus*) is a mammal that is within the weasel and mongoose (*Viverridae*). It is a nocturnal carnivore type of mammal. Despite its nature as a carnivore, mongoose also eats ripe fruits, and one of them is fully ripe coffee beans [4].

A coffee bean is coated by hard skin that cannot be digested by mongoose, therefore it is let out in one piece along with its feces. During the digestive process, the coffee has been through a fermentation process for  $\pm 12$  hours within mongoose's digestive tract. While the beans that cannot be digested are excreted in the feces during the excretion process [14].

The fermentation process that occurs inside mongoose contributes to produce a unique taste and aroma [3]. Such taste and aroma are of the attractive value to coffee lovers, resulting in the rise of the product demands in both local and international markets in every year [17].

The year-to-year increase of demands happens in several countries, such as Germany, Japan, the United States, and some European countries. The continuous increase of demands, somehow, complicates the mongoose coffee producers [7]. The increase is also caused by the selling price of Indonesia's mongoose coffee is set at 600 Canada dolar per pon, and considered as the rarest and most expensive drink or coffee in the world [9] while [11] stated that the international price has reached \$100 to \$600.

As the demands keep increasing, the mongoose hunting is also in a rise; threatening the population of mongoose in Indonesia [1], [16]. Besides, as the mongoose gets rarer and its digestive capacity is limited, the production is also limited. One of the alternative to optimize the production of mongoose coffee is to use in-vitro fermentation by manipulating microbes (particularly lactic acid

---

<sup>64</sup> Universitas Muhammadiyah Jember,  
[kukuhmunandar@unmuhjember.ac.id](mailto:kukuhmunandar@unmuhjember.ac.id)

bacteria) to replicate the process of natural fermentation which occurs inside the mongoose digestive organs. The lactic acid bacteria is functioned as a culture starter for fermentation in food industry [8].

## **Procedure**

### **Bacteria Isolation from Mongoose Feces**

The process of bacteria isolation started from collecting 1 g of mongoose feces which was put into a test tube containing 9 ml of sterile aquades. This dilution process was done by taking 1 ml suspension of culture bacteria into the test tube (10-1) that contained yang berisi 9 ml of sterile aquades. The following process was to take 1 ml of diluted 10-1 and put it into the tube 10-2, and the process was repeated until 10-5. Afterwards, each suspense was taken as much as 1 ml from the test tube and put into the petri dish. The media used to grow the cellulolytic bacteria was the CMC media by applying the pour plate method.

### **Screening and Purifying Bacteria Isolates**

Bacteria screening was done by observing the formation of clear zone on the CMC media. The growing bacteria which formed a clear zone on the media was examined to identify its morphological characteristics and then purified by applying the scratch method on the petri dish. Single bacteria isolates on CMC were grown using the scratch method in order to form a circle of bacteria with a diameter less than 1 cm on the petri dish, and then incubated for 24 hours under the temperature of 37°C. The growing bacteria isolates were given drops of congo red reagent 0,1% until covering the whole media surface for 1 minute. It was then washed using NaCl 1%. The positive result was indicated by the successful formation of clear zone in the surrounding of the bacteria colony.

### **Characteristics of Cellulolytic Bacteria**

Bacteria isolates which are possible for the cellulolytic bacteria were characterized following the result of observed characteristics of colony morphology, cells, and biochemistry test [12]; [6].

### **Bacteria Identification**

Identifying proteolytic and cellulytic bacteria of mongoose feces was done by observing the common characteristics of the bacteria which have been characterized using the book of

determination key from Bergey's Manual of Determinative Bacteriology.

### Examination Parameter and Data Analysis of Bacteria Isolation

The parameter being examined in the present study is the bacteria colony which forms the clear zone, and which bacteria isolates characteristics containing examination on morphological characteristics of colony and cell, and physiological characteristics as seen from the biochemistry test. The gathered data was analyzed descriptively and presented in tables and figures.

### Result and Discussion

The bacteria isolation which was assumed to be LAB resulted in 5 isolates. Afterwards, the isolates assumed to be LAB were identified in accordance with LAB characteristics.

**Table 1. Characteristics of isolates, results from tests of cell shape, gram coloring, CO<sub>2</sub>, and catalase**

No.	Isolate	Cell Shape	Gram Coloring	O <sub>2</sub> Test	Catalase Test
1	LAB-1	coccus	+	-	-
2	LAB-2	Coccus	+	-	-
3	LAB-3	Coccus	+	-	-
4	LAB-4	Coccus	+	-	-
5	LAB-5	Coccus	+	-	-

**Table 2. Characteristics of LAB isolates for growth in different temperatures**

No.	Isolate	Growth in Temperature		
		15°C	37°C	45°C
1	LAB-1	+	+++	+
2	LAB -2	+	+++	+
3	LAB -3	+	+	++
4	LAB -4	+	++	+++
5	LAB -5	-	+	+++

**Table 3. Characteristics of LAB isolates by Acid Production Test (Litmus Milk) and Blue Litmus**

No	Isolate	Growth	Precipitate	Result
1	LAB-1	Separation/clumping of milk, upper red, lower white	++	+++
2	LAB -2	Separation/clumping of	+++	+



		milk, upper white, lower blue		
3	LAB -3	Separation/clumping of milk, upper white, lower blue	++	+
4	LAB -4	Separation/clumping of milk, upper red, lower white	+++	+++
5	LAB -5	Separation/clumping of milk, upper white, lower red	+++	++

**Table 4. Characteristics of LAB isolates by Acid Production Test (Litmus Milk) and Red Litmus**

No	Isolate	Growth	Precipitate	Result
1	LAB-1	Separation/clumping of milk, upper red, lower white	+++	+++
2	LAB -2	Separation/clumping of milk, upper white, lower blue	++	+++
3	LAB -3	Separation/clumping of milk, upper white, lower blue	++	+++
4	LAB -4	Separation/clumping of milk, upper red, lower white	+	++
5	LAB -5	Separation/clumping of milk, upper white, lower red	+++	+

**Table 5. Characteristics of LAB isolates by Growth Test on Salt Concentration Variety**

No	Isolate	Salt Concentration		
		0 %	4 %	6,5 %
1	LAB-1	++	+++	+++
2	LAB -2	++	+++	+++
3	LAB -3	++	+++	+++
4	LAB -4	+++	+++	++
5	LAB -5	+++	+++	++

Based on the results of isolation and characteristics test, 5 LAB isolates are obtained, namely: LAB-1 bacteria that is *Lactobacillus plantarum*, LAB-2 is *Lactobacillus brevis*, LAB-3 is *Leuconostoc paramesenteroides*, LAB-4 is *Leuconostoc mesenteroides*, and LAB-5 is *Streptococcus faecium*.

The finding of this study is confirmed by that of [15] stating that proteolytic bacteria in mongoose feces is *Bacillus* genus and *Proteus* genus. Meanwhile, [5] have isolated 3 bacteria isolates of *Lactobacillus* genus with the following species: *Lactobacillus*

*plantarum*, *Lactobacillus fermentum*, and *Lactobacillus Jensenii*. Another previous study has identified *Lactobacillus sakei*, *Lactobacillus curvatus*, and *Lactobacillus plantarum* [10]. Generally, lactic acid bacteria involved in the fermentation are of the following species: *Lactobacillus casei*, *Lactobacillus coryniformis*, *Lactobacillus curvatus*, *Lactobacillus plantarum*, *Lactobacillus plantarum*, *Lactobacillus plantivum*, *Lactobacillus salivarius*, *Lactobacillus feractus*, *Lactococcus lactis*, *Pediococcus acidilactici*, *Pediococcus parvulus*, *Pediococcus pentosaceus* and those from *Leuconostoc* and *Weissella* genera [18].

LAB is commonly used as a culture starter in a fermentation and some of them are also parts of the natural component of intestinal microflora [2]. Furthermore, they stated that the primary LAB are *Lactobacilli* and *Bifidobacteria*, as they are the most commonly used potential probiotic to improve health because they have several therapeutic functions. Besides, LAB can enhance aroma and flavor [13].

## Conclusion

Based on the result and data analysis, the study is concluded in the following points: 1) bacteria which are within LAB of local mongoose feces of Jember include five LAB isolates, such as: LAB-1 is *Lactobacillus plantarum*, LAB-2 is *Lactobacillus brevis*, LAB-3 is *Leuconostoc paramesenteroides*, LAB-4 is *Leuconostoc mesenteroides*, and LAB-5 is *Streptococcus faecium*, and 2) the quality of coffee as examined from its taste in in-vitro fermentation results in two isolates with tastes closest to mongoose coffee, namely LAB-1 (*Lactobacillus plantarum*) and LAB-4 (*Leuconostoc mesenteroides*).

## References

- [1] Carder, G., H Proctor, J Schmidt-Burbach, and N D'Cruze (2016). The animal welfare implications of civet coffee tourism in Bali. *Animal Welfare*, 25: 199-205 (doi: 10.7120/09627286.25.2.199).
- [2] Chakraborty, A. and J. Bhowal (2015). Isolation, Identification and Analysis of Probiotic Properties of *Lactobacillus* Spp. from Selected Regional Dairy Product. *Int.J.Curr.Microbiol.App.Sci*, 4(6): 621-628
- [3] Chan, S., and E. Garcia (2011). Comparative Physicochemical Analyses of Regular and Civet Coffee. *The Manila Journal of Science*, 7(1): 19-23.

- [4] Cheyne, S. M. et al. (2010). Diversity and activity of small carnivores of the Sabangau Peat-swamp Forest, Indonesian Borneo. *Small Carnivore Conservation*, 43(December 2010): 1–7.
- [5] Hadipernata, M. dan S. Nugraha (2012). Identifikasi Fisik, Kimia Dan Mikrobiologi Biji Kopi Luwak Sebagai Dasar Acuan Teknologi Proses Kopi Luwak Artificial. *Prosiding InSINas 2012*: PG-117-121
- [6] Hassan P., and Peh Kok (2019). Confirmation of the Identity of Lactobacillus Species using Carbohydrate Fermentation Test (API 50 CHL) Identification System. *Journal of Applied Sciences*, 19(8): 797-802, DOI: 10.3923/jas.2019.797.802
- [7] Kompas.com (2009). Permintaan Tinggi, Ekspor Kopi Luwak Dibatasi. (daring) <https://tekno.kompas.com/read/2009/10/29/18532371/permintaan.tinggi.ekspor.kopi.luwak.dibatasi>.
- [8] Leroy, F. and L. De Vuyst (2004). Lactic acid bacteria as functional starter cultures for the food fermentation industry. *Trends in Food Science & Technology*, 15 (2004): 67–78.
- [9] Marcone, MF. (2004) Composition and Properties of Indonesian Palm Civet Coffee (Kopi Luwak) and Ethiopian Civet Coffee. *Food Research International*, 37 (2004): 901–912 doi:10.1016/j.foodres.2004.05.008
- [10] Monique Zagorec, Jamila Anba-Mondoloni, Anne-Marie Crutz-Le Coq, and Marie-Christine Champomier-Vergès (2008). Genetics of Lactic Acid Bacteria. In Toldr', F. (Ed.) (2008). *Meat Biotechnology*. (2008). New York: Springer Science+Business Media, LLC.
- [11] Muzaifa, M., A. Patria, A. Abubakar, F. Rahmi, D. Hasni, I. Sulaiman, dan Febriani (2006). *Kopi Luwak: Produksi, Mutu Dan Permasalahannya*. Aceh: Syiah Kuala University Press.
- [12] Ogunyemi, A., B.C. Ogunyemi, A.L. Ategun, B.A. Iwalokun, J.I. Ike, M.O. Ilori, and O.O. Amund. (2020). Isolation and characterisation of nitrilase producing *Aspergillus* species recovered from solid waste leachates at two dump sites in Lagos, Nigeria. *Malaysian Journal of Microbiology*, Vol. 16(3): 2020, pp. 153-158, DOI: <http://dx.doi.org/10.21161/mjm.180234>
- [13] Pessoa, MG., Vespermann, KAC., Paulino, BN., Barcelos, MCS., Pastore, GM., and Molina, G. (2019). Newly Isolated Microorganisms with Potential Application in Biotechnology. *Biotechnology Advances*. 37(2): 319-339. DOI: 10.1016/j.biotechadv.2019.01.007

- [14] Rahayu, S., Rahmawati, dan R. Kurniatuhadi (2018). Deteksi Bakteri Selulolitik pada Kotoran Luwak (Paradoxurus hermaphroditus) dari Kebun Binatang Bandung. *Protobiont*, 7(2): 19 – 28
- [15] Rahmawati, NHF. (2017). Isolasi dan Karakterisasi Bakteri Proteolitik dari Feses Hewan Luwak (Paradoxurus hermaphroditus). *Jurnal Prodi Biologi*, 6(1): 1-8
- [16] Shepherd, C.R. (2012). Observations of small carnivores in Jakarta wildlife markets, Indonesia, with notes on trade in Javan Ferret Badger *Melogale orientalis* and on the increasing demand for Common Palm Civet *Paradoxurus hermaphroditus* for civet coffee production. *Small Carnivore Conservation*, Vol. 47: 38–41, December 2012.
- [17] Suhandy, D. and M. Yulia (2017). The Use of Partial Least Square Regression and Spectral Data in UV-Visible Region for Quantification of Adulteration in Indonesian Palm Civet Coffee. *International Journal of Food Science*, Volume 2017, Article ID 6274178, 7 pages, <https://doi.org/10.1155/2017/6274178>
- [18] Valerio, F., M. Favilla, P. De Bellis, A. Sisto, S. de Candia, and P. Lavermicocca (2009). Antifungal activity of strains of lactic acid bacteria isolated from asemolina ecosystem against *Penicillium roqueforti*, *Aspergillus niger* and *Endomyces fibuliger* contaminating bakery products. *Systematic and Applied Microbiology*, 32 (2009): 438–448

# Learning Geometry and Values from the Begalan Tradition: Ethnomatematic in Begalan Culture of Banyumas, Indonesia

Kusno<sup>65</sup>, Umy Zahrah<sup>66</sup>, Reni Astuti<sup>67</sup>, Muchtadi<sup>68</sup>, Kusaeri<sup>69</sup>,  
Triyono<sup>70</sup>

## Introduction

Mathematics cannot be separated from cultural development so that mathematics learning must respect the cultural context [19]. Therefore, in order for students to learn mathematics effectively, they need a bridge between mathematics and culture in the form of ethnomathematics [25]. This is in line with the opinion of [6];[27] that the more relevant mathematics lessons to real life, the less correlation there is between mathematics and student understanding. Studies related to ethnomathematics are currently being carried out by researchers from all over the world. For example, examined the effect of using ethnomathematical ornamentation to study the congruence of triangles in Palestine. Examines insights about teacher awareness of the use of ethnomathematics in geometry learning in South Africa [27]. Researched ethnomathematics in the Beskalan Putri Malang Dance in Indonesia. Researching ethnomathematics in the Temple of Heaven, one of the famous heritage sites in Beijing, China [31]. Investigated the enculturation of mathematics in Ethiopia to help develop a culture-responsive mathematics education curriculum. Furthermore, emphasized that the Ethnomathematics-based curriculum helps students demonstrate a consistent mathematical process as they reason, solve problems, communicate ideas, and choose appropriate representations through the development of everyday mathematical practices.

The results of the research that have been discussed indicate the importance of developing teaching materials for mathematics education curriculum from cultural heritage artifacts, but the

---

<sup>65</sup> Universitas Muhammadiyah Purwokerto Indonesia,  
[kusnoump@gmail.com](mailto:kusnoump@gmail.com)

<sup>66</sup> UIN Sayyid Ali Rahmatullah Tulungagung Indonesia

<sup>67</sup> IKIP PGRI Pontianak Indonesia

<sup>68</sup> IKIP PGRI Pontianak Indonesia

<sup>69</sup> UIN Sunan Ampel Surabaya Indonesia

<sup>70</sup> Universitas Widya Dharma Klaten Indonesia

pedagogical values of cultural heritage which are very important for the formation of students' character have not been touched. Therefore, this study focuses on the ethnomathematical aspects that contain pedagogical meanings, especially in the Indonesian Banyumas Begalan Tradition. Thus, this study aims to explore mathematical concepts, especially geometry and pedagogical values in the Indonesian Begalan Banyumas tradition. The results of this study have at least 2 important contributions, firstly enriching teaching materials for school mathematics education in the field of geometry that are closer to student culture, and as a vehicle for strengthening national character education.

Ethnomathematics is the study of the relationship between culture and mathematical concepts. The main idea that mathematics is a product of socio-historical and cultural processes has developed with contributions from various cultures in society, and has given rise to what we now understand as school mathematics [4]. In addition, that ethnomathematics is related to how mathematics is produced, transferred, disseminated, and specialized in diverse cultural systems [31]. Knowing and understanding the value of pluralism, social aspects, economic, political and cultural aspects of diverse societies is a necessity in order to innovate learning that is more contextual and meaningful. According to the main goal of ethnomathematics is to build a civilization free from violence, arrogance, intolerance, discrimination, injustice, bigotry and hatred. In addition, to understand the relationship between mathematics and culture, so that students and society's perceptions of mathematics become more precise and easy to understand [24] and to rebuild individual dignity, acknowledge and respect their cultural roots [21]. In ethnomathematics there are cognitive, conceptual, educational, epistemological, historical and political dimensions. An understanding of aspects of ethnomathematical studies can be a new perspective for adopting culture-based learning [20]. Revealed that the ethnomathematical approach requires students to use everyday experiences in building their understanding [3]. S stated that through ethnomathematics students can take lessons easily and recognize their own culture [17]. Through ethnomathematics students can carry out the process of abstraction, idealization, and generalization about geometric objects [16].

Suggests that ethnomathematics is a relatively new field of study that is supported by many researchers in the field of mathematics education [7]. Recently, research in the field of

ethnomathematics is growing rapidly. Examined the habits of the Kabihug community in the Philippines in carrying out simple calculations, encoding [11], classifying, sorting, inferring and modeling patterns that arise from the environment to develop learning in schools. Examined the Hatam language related to the addition of sums in Abacus [8]. Examines the Balinese I traditional house with the concept of similarity, shift and reflection [28]. Researched the Kudus tower related to spatial structures [30]. Researched Javanese primbon about matchmaking predictions to develop residual and modulo theorem material [29]. Examined the activities of cocoa farmers in Temusari Sempu Banyuwangi village and succeeded in finding the concepts of comparison and social arithmetic as teaching materials for students' mathematics [5]. Researched the Borobudur Temple in Magelang Indonesia to explore data geometry materials and fractal geometry [13]. Using ethnomathematics as an approach and teaching method may vary depending on the culture of the students. Studied the Ornaments of the Great Mosque of Bandung to explore Geometry transformation material [22].

Recommend ethnomathematics to develop school mathematics curriculum [26]. This is intended so that mathematics is closer to their culture so that it is more realistic and more meaningful. Based on the results of research, ethnomathematics-based mathematics teaching materials have been proven to be effective on students' mathematical problem solving and critical thinking skills [10]. In addition, the mathematical understanding of students who are ethnomathematically oriented is higher than students who are not ethnomathematically oriented [9]. According to [18], learning geometry in schools is more effective and meaningful if it is associated with experiences and activities found in the students' own cultural environment. Teachers' awareness of cultural examples and activities that can be integrated into geometry teaching, has the potential to influence their understanding of how students acquire geometric concepts

Indonesia is a multicultural country [14];[1];[2] because Indonesia has 17,481 islands and 718 regional languages, and a very diverse cultural wealth, one of which is the Begalan art which is the cultural wealth of Banyumas Indonesia.

The Begalan tradition during the wedding ceremony, is a cultural characteristic of the Indonesian Banyumas people which is very important to be inherited. Because many traditional cultures in Indonesia are now almost forgotten by the younger generation [23].

Begalan is a form of ritual as well as art that is very important in the wedding ceremony in Banyumas because in addition to having a function as a means of repelling reinforcements, it contains da'wah values, educational values, and social values that are intended for the bride and the community who attend the ceremony. Begalan performing arts not only discuss marriage advice but also provide teachings that must be carried out in the process of socializing social life and obligations that must be carried out to God [15]. Begalan art performance is a medium for transferring educational values that is useful as a demand for human daily actions, both as God's creatures and as members of society. The Begalan tradition in its implementation uses *ubo rampe* or equipment consisting of household utensils as teaching aids to explain how married life is, because each piece of equipment brought has its own meaning. Explained that Begalan is a combination of dance and folklore that involves humor accompanied by traditional musical instruments which usually occurs in the front yard of the bride and groom [12]. In their performance, the two dancers engage in dialogue containing important advice for the bride and groom. The two dancers each play a role as *Gunareka* (representative of male friends) and *Rakaguna* (representative of female friends). The conversation between *Gunareka* and *Rekaguna* [15] discussed the use of each property as well as their symbolic meaning. After the conversation ended, *Rekaguna* broke the *kendhil* containing the coins as a symbol that the obstacle had disappeared.

## Results and Discussion

Begalan is an artistic tradition of the Indonesian Banyumas people, to give advice about domestic life to the two friends which is expressed in the form of dance art using household utensils called *Brenong Kepang* which has pedagogical meaning. Data collection in Karangwangkal Village, Banyumas Regency at the wedding of Tedy Agus Permana bin Samiran Sokaraja Banyumas with Amalia Sufia Khajar bin Adi Suryanto Karangwangkal Banyumas. The *Brenong Kepang* brought as *ubo rampe* (equipment) from Begalan were (1) *Pikulan* (2) *Ian* (3) *Iilir* (4) *Steam* (5) *Siwur* (6) *Cething* (7) *Kekeb* (8) *Tampah*, and (9) *Kendil* contains *Cirri*-covered coins, and all of which will be explained later. All of the utensils are made of bamboo except for the *kendil* and *cirri* which are made of earth. *Brenong Kepang* is very closely related to the philosophy of human life, especially for the

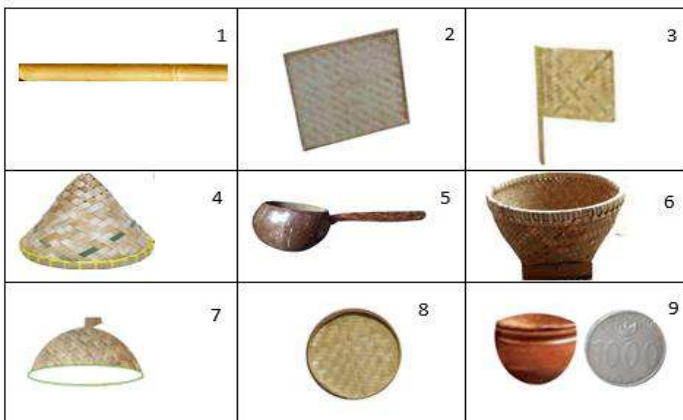


bride and groom who will live a new life. The complete picture of Brenong Kepang can be seen in Figure 1 below:



**Figure 1. Begalan Scene in Karangwangkal Banyumas Indonesia**

In the *Begalan* ritual there are textual meanings, contextual meanings and symbolic meanings. The textual meaning is in the form of household advice to the bride and groom about what should be done and what should not be done when starting a married life. The contextual meaning of *begalan* is a request for salvation in the world for the life of the bride and groom in navigating their new life. While the symbolic meaning is related to the philosophy of *Brenong Kepang* whose picture is presented in Figure 2 below.

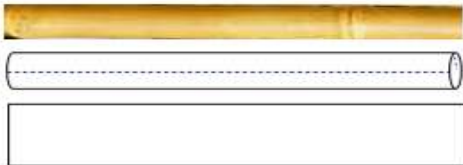


**Figure 2. Brenong Kepang (household utensils) Begalan equipment**

From the recorded dialogue between Gunareka and Rakaguna during Begalan and matched with the results of interviews, field notes and geometric mathematical concepts, the meanings of Brenong Kepang can be explained as follows:

### **Pikulan**

*Pikulan* is a tool to carry two balanced loads, in the tradition of begalan pikulan gives a message that in the household there must be a balance between male and female brides known as sekufu which means equal. *Pikulan* also hints at the meaning of mikul duwur mendem jero, meaning that some household burdens are heavy and some are light, therefore all things must be shared. *Pikulan* is made of bamboo in the form of a tube. *Pikulan* can be used to teach students on tube material, both the area of the tube blanket and the volume of the tube.



A *Pikulan* with radius  $r$  and height  $t$  then:

(1) Volum of *Pikulan* =  $\pi r^2 t$

(2) Area of *pikulan* blanket =  $2\pi r t$

**Figure 3. *Pikulan* is tubular**

### **Ian**

*Ian* is a woven bamboo that serves as a base for spreading rice to cool quickly. In the Begalan tradition, *Ian* is used to describe the universe which has four cardinal directions, namely east, west, north and south. Humans who are given the gift of creativity, taste and intention are given the mandate to take care of the universe so that life in the world can be safe, peaceful and peaceful. The way to take care of the universe is to establish brotherhood between *sedulur tuwo* and *sedulur nom* (older and younger siblings). *Ian* is a geometric figure in the form of a rectangular area. *Ian* can be used to introduce plane material such as the area and perimeter of a rectangle.



An *Ilan* with length  $p$  and width  $l$  units, then:

- (1) *Ilan's* area is  $p.l$
- (2) *Ilan's* perimeter is  $2(p+l)$

**Figure 4. *Ilan* is a rectangular area**

### **Ilir**

*Ilir* is a fan made of woven bamboo that functions as a rice cooler. In the tradition of Begalan *Ilir*, it is often referred to as *Susuhing Angin*, which means the source of the wind which serves to give a message that someone who is married can distinguish between good and bad deeds so that they can make wise decisions. *Ilir* can also mean big universe small universe. Home life has just entered a small universe. *Jagad* in *ilir* includes 4 angles which means that the bride and groom must be able to provide coolness to 4 things, namely father, mother, father-in-law, and mother-in-law. The function of *ilir* is to be able to cool fellow partners if there is chaos. In addition, *ilir* can also eliminate unpleasant odors. *Ilir* is in the form of a rectangular area that has a handle, so it can teach students about the perimeter and area of a square.



An *Ilir* whose side length is  $s$  then:

- (1) *Ilir* area is  $s^2$
- (2) Circumference of *Ilir* is  $4s$

**Figure 5. *Ilir* leaves in the form of a square area**

### **Kukusan**

*Kukusan* is a household appliance made of woven bamboo and serves to cook rice. *Kukusan* gives a message that people who are married must struggle to make ends meet as much as possible. *Kukusan* also gives a strong message in holding to the principles of (1) *metu*, which is to go out for *bebrayan* (building togetherness), (2) *mengkurep*, which is to remember both parents, (3) *mlumah*, which is to remember the Almighty, and *modot*, which is to be critical, creative and innovative in realizing one's dreams. wish. *Kukusan* is in the form

of a cone that can be used to teach students, especially the volume and area of the cone blanket.



A *kukusan* with radius  $r$ , height  $t$  and painter's line  $s$  then:

- (1) Volum of *kukusan* =  $\frac{1}{3}\pi r^2 t$
- (2) Surface area of *kukusan* =  $\pi r(r+s)$

**Figure 6. Cone-shaped *kukusan***

### ***Siwur***

*Siwur* is a household appliance made of coconut shell and serves to fetch water. *Siwur* (Javanese) means not to be inconsequential (not at will). In the *Begalan siwur* tradition, it conveys the message that in household and social life, a person cannot live as he pleases himself, but must always follow the applicable rules in order to be able to coexist with other people in his environment. *Siwur* also gave a message that people who are married must be able to control their lusts, don't easily spread feelings of love to others. *Siwur* is in the form of a hemispherical shape that can be used to teach students to calculate the volume of a half sphere and the surface area of a half sphere.



*Siwur* with radius  $r$  then:

- (1) Volum of *Siwur*  $\frac{2}{3}\pi r^3$
- (2) Surface area of *siwur* =  $2\pi r^2$

**Figure 7. Half -ball -shaped *siwur***

### ***Cething***

*Cething* is a household utensil made of woven bamboo and serves as a rice container. In the *Begalan* tradition, *cething* describes a container or organization in society that has certain rules. *Cething* is also called a *wakul* in the form of an ellipsoidal beak that is hollow so that the air can circulate properly to keep the rice from going stale quickly.



*Cething* with major axis  $a$  and minor axis  $b$  then  
 Volum of *cething* is  
 $\frac{4}{3}\pi ab^2$

**Figure 8. *Cething* as half ellipsoid**

***Kekeb***

*Kekeb* is a household utensil made of woven bamboo and serves as a cover for the *kukusan* when cooking rice. In the *Begalan* tradition, *kekeb* gives a message that in domestic life husband and wife must be able to cover each other's shortcomings. *Kekeb* is a geometric shape in the form of a half ball



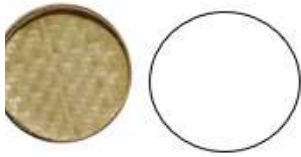
*Kekeb* with radius  $r$  then:

- (1) Volum of *kekeb*  $\frac{2}{3}\pi r^3$
- (2) Surface area of *kekeb*  $2\pi r^2$

**Figure 9. *Kekeb* in the form of a half ball**

***Tampah***

*Tampah* is a household utensil that serves to *nyunggi* (carrying things over the head). In addition, winnowing also functions as a sieve, namely selecting between the rice to be cooked and the dirt that must be removed. In the *Begalan* tradition, it symbolically appears to give a message to protect the disgrace from the shortcomings of both parties. In addition, it also gives a message that people who are married must be able to select good and bad words and actions. *Tampah* is in the form of a circular area that is surrounded by bamboo so that it is strong and can be used to carry a number of items. *Tampah* can be used to teach students about the area and circumference of a circle.



- tampah* with radius  $r$  then:
- (1) Wide of *tampah* =  $\pi r^2$
  - (2) Perimeter of *tampah*  $2\pi r$

**Figure 10. *Tampah* as a circle area**

### ***Kendil, Cirri and Coin***

*Kendil* is a household appliance made of soil and serves as a place to store goods/food. Usually the *kendil* is closed by using *cirri*. Aside from being a lid for the *cirri* *kendil*, it also functions as a container for softening cooking spices (such as chili, salt, sugar, onions and others) or making chili sauce. In the Begalan tradition, *kendil* gives a moral message to live a life of *gemi nastiti ngati-ati* (frugal). *Cirri* gives a message that people who are married must be able to organize various kinds of differences so as to produce a strong and beautiful unity. Inside the *kendil* there are a number of coins that are ready to be grabbed after the *begalan* is over. Coins describe the sustenance that everyone in a household should look for. *Kendil* berbentuk bangun setengah elipsoidal sedangkan *coin* berbentuk daerah lingkaran.



**Figure 11. *Kendil, Cirri and coin***

- Kendil* with major axis  $a$  and minor axis  $b$  and coin with radius  $r$  then:
- (1) Volum of *kendil*  $\frac{4}{3}\pi ab^2$
  - (2) Area of coin =  $\pi r^2$
  - (3) Perimeter of coin =  $2\pi r$

### **Conclusion**

Ethnomathematics provides hope for the future to bring mathematics closer to students realistically, as well as to promote the culture of a society with dignity. Furthermore, ethnomathematics can be used as a sector of mathematics curriculum development in Indonesia. The people of Banyumas have used the concept of geometrical shapes and flat shapes to make household utensils (*Breanong Kepang*) as well as Begalan art equipment containing pedagogical values to give advice to the bride and groom in entering the household ark.

### ***Acknowledgement***

We would like to thank the Research and Community Service Institute for providing support in research funding and also to the begalan association who has been willing to provide research data and to all parties who have supported the implementation of this research.

### **References**

- [1] Abdullah, A.S (2017). Meneliti penggunaan satuan ukuran, pemodelan matematika dan pemodelan jam simbolik yang biasa dipakai warga desa Cipatujah Tasikmalaya dalam kegiatan ekonominya. *Jurnal Elemen* Vol. 6 No. 2, Juli 2020, hal. 277 – 301
- [2] Abdullah, A.S. (2017). Ethnomathematics in perspective of sundanese culture. *Journal on Mathematics Education*, 8(1), 1-16
- [3] Aikpitanyi LA & Eraikhuemen L (2017). Mathematics Teachers' Use of Ethnomathematics Approach in Mathematics Teaching in Edo State. *Journal of Education and Practice* www.iiste.org ISSN 2222-1735 (Paper) ISSN 2222-288X (Online) Vol.8, No.4, pp. 34-38
- [4] Albanese, V & Perale, FJ. 2015. Enculturation with Ethnomathematical Microprojects: From Culture to Mathematics. *Journal of Mathematics & Culture* 9(1), pp. 1-11
- [5] Aprilianti, I, Sunardi, S., & Yudianto, E. (2019). Etnomatematika pada aktivitas petani kakao desa temuasri sempu banyuwangi sebagai bahan ajar siswa. *Saintifika*, 21(1), 1-8
- [6] Arisetyawan, A., Suryadi, D, Herman, T, Rahmat, C. 2014. Study of Ethnomathematics: A lesson from the Baduy Culture. *International Journal of Education and Research* Vol. 2 No. 10. Pp
- [7] Cimen, O.A. 2014. Discussing ethnomathematics: Is mathematics culturally dependent? *Procedia - Social and Behavioral Sciences* 152 (2014) 523 – 528
- [8] Haryanto, Nusantara T, Subanji, Rahardjo S. 2017. Ethnomathematics In Arfak (West Papua Indonesia): Numeracy of Arfa. *International Journal of Scientific & Technology Research: Vol 6, Issue 09*
- [9] Herawaty D, Sarwoedi S, Marinka, Febriani and Wirne. 2019. Improving student's understanding of mathematics through ethnomathematics. *IOP Conf. Series: Journal of Physics: Conf. Series* 1318 (2019) 012080
- [10] Imswatama, A., Lukman, H.S (2018). The effectiveness of mathematics teaching material based on ethnomathematics.

- International Journal of Trends in Mathematics Education Research Vol. 1, No. 1, June 2018, pp. 35-3
- [11] Jennifer S, Rubio. 2016. The Ethnomathematics of the Kabihug Tribe in Jose Panganiban, Camarines Norte, Philippines. Malaysian Journal of Mathematical Sciences 10(S) August: 211-231
- [12] Kholifah, A.N. 2018. Rendering cultural elements in banyumasan begalan: a translation studies perspective. Jurnal Ilmiah Lingua Idea ISSN 2580-1066 (Online) ISSN 2086-1877 (Printed) Vol. 9 No. 2, pp
- [13] Kurniawan, W. & Hidayati, T. (2020). Ethnomathematics in Borobudur Temple and Its Relevance in Mathematics Education: A Literature Study. Jurnal Pendidikan Progresif, 10(1), 91-104.
- [14] Kusuma D.A., Dewanto, S.P., Ruchjana, B.N., Abdullah, A.S. 2017. The role of ethnomathematics in West Java. IOP Conf. Series: Journal of Physics: Conf. Series 893 (2017) 012020
- [15] Lestari, P. 2013. Makna simbolik seni begalan bagi pendidikan etika masyarakat. HARMONIA, Volume 13, No. 2, hal. 157-167
- [16] Lusiana, D., Afriani, NH., Ardi, H., Widada, W. 2019. Etnomatematika pada masjid jamik kota bengkulu. Jurnal Pendidikan Matematika Reflesia Vol 04 No. 02, pp.164-176
- [17] Mania, S. & Alam, S. (2021). Teachers' perception toward the use of ethnomathematics approach in teaching math. International Journal of Education in Mathematics, Science, and Technology (IJEMST), 9(2), 282-298.
- [18] Mogari, D. (2014). An in-service programme for introducing an ethnomathematical approach to mathematics teachers. Africa Education Review, 11(3), 348-364. <https://doi.org/10.1080/18146627.2014.934992>
- [19] Muhtadi D, Sukirwan, Warsito, Prahmana RCI (2017). Sundanese ethnomathematics: mathematical activities in estimating, measuring, and making patterns. Journal on Mathematics Education Volume 8, No. 2, pp. 185-198
- [20] Nur, A.S, Sukestiyarno, YL, & Junaedi, I (2019). Etnomatematika dalam perspektif problematika pembelajaran matematika: tantangan pada siswa indigenous. Prosiding Seminar Nasional Pascasarjana UNNES, 910-914
- [21] P. Valero & O. Skovsmose (2002) (Eds.). Proceedings of the Third International MES Conference. Copenhagen: Centre for Research in Learning Mathematics, pp. 1-15



- [22] Purniati T, Turmudi, Juandi, Suhaed D (2021). Ethnomathematics exploration of the masjid raya bandung ornaments in transformation geometry materials. *Journal of Medives: Journal of Mathematics Education IKIP Veteran Semarang* Volume 5, No. 2, 2021, pp. 235-243
- [23] Putri, I. 2017. Eksplorasi etnomatematika kesenian rebana sebagai sumber belajar matematika pada jenjang mi. *Jurnal Ilmiah "Pendidikan Dasar"* Vol. IV No. 1
- [24] Risdiyanti I & Prahmana RCI (2020). Ethnomathematics Teori dan Implementasinya: Suatu Pengantar. UAD Press Ruang LPPI, Kampus 4 UAD, Lt. 9 Jl. Ringroad Selatan, Tamanan, Bantul
- [25] Risdiyanti I & Prahmana, RCI. (2017). Ethnomathematics: Exploration in Javanese culture. *IOP Conf. Series: Journal of Physics: Conf. Series* 943 (2017) 012032
- [26] Rosa, Dambrosio & Orey DC (2016). Current and future perspectives of ethnomathematics as a program
- [27] Sunzuma, G & Maharaj, A (2020): In-service mathematics teachers' knowledge and awareness of ethnomathematics approaches, *International Journal of Mathematical Education in Science and Technology*, DOI: 10.1080/0020739X.2020.1736351
- [28] Suharta, IGP (2017) Ethnomathematics of Balinese Traditional Houses. *International Research Journal of Engineering, IT & Scientific Research*. Vol. 3 No. 4, pp 47-56
- [29] Utami NW, Sayuti S & Jaelani (2019) Math and mate in javanese primbon: ethnomathematics study. *Journal on Mathematics Education* Volume 10, No. 3, pp. 341-35
- [30] Zaenuri & Dwidayati N. 2018. Exploring ethnomathematics in Central Java. *IOP Conf. Series: Journal of Physics: Conf. Series* 983 (2018) 012108.
- [31] Zhang, W, & Zhang, Q., 2010. Ethnomathematics and Its Integration within the Mathematics Curriculum. *Journal of Mathematics Education © Education for All* June 2010, Vol. 3, No. 1, pp.151-157

# The Sustainability of Maritime Eco-Lexicon of Bungku Language in Morowali Regency

La Ino<sup>71</sup>, Samsul, Maliudin

## Introduction

Bungku language is one of the local languages in Middle Sulawesi Province. The user of this language is found in the South Bungku district Morowali Regency. The location of this research is in Kaleroang and Paku village South Bungku district. In daily life, it seems that the use of the Bungku language slightly decreases especially for the young generation. It can be seen clearly by the scarce usage of the lexicon of the Bungku language compared with the Malayan language. This condition becomes worries because it can make the eco-lexicon of Bungku language primarily maritime eco-lexicon. One of the factors that become the main cause of Bungku language extinctions is that parents do not speak the Bungku language to their children. The research question in this research is that to what extent is the sustainability of the maritime eco-lexicon of Bungku language to describe deeply the sustainability extent of maritime lexicon of Bungku language. The theory used in this research is ecolinguistic.

[1] Sustainability of language is that how far an individual or group keeps using their language particularly in dual languages or multi-languages region or among the immigrant group, whereas the shift of language is that the process in which new language is obtained by a new community is usually resulted in with the extinction of their first language community. Language maintenance refers to the situation in which the community keeps using traditional language in dealing with several conditions that probably push the shift to another language. [2] Fishman defines language resistance can be said as the reversing language shift.

[3] Language skill to survive according to is influenced by three components, namely: 1) the language status concerned that is reflected on the attitude of language community towards it; 2) a big language user group and its distribution, and 3) to what extent the language gets institutional support.

The maritime is everything related to marine things. [4] explained that the number of articles in the Qoran that speak about

---

<sup>71</sup> Universitas Halu Oleo, Indonesia, [laino@uho.ac.id](mailto:laino@uho.ac.id)

the marine things and all of its secrets as many as 32 articles and the land as many as 13 articles. The number of both is 45 articles. Accordingly, the article that speaks about marine things is divided by 45 and is multiplied by 100% equals 71%. This phenomenon is also instilled on the Earth planet that we reside in which two-third or 71 % of the earth's surface is covered by the sea and one-third or 29% island. Likewise, Indonesia's country area that lies along the Equator line is also covered more than 71% of the sea. The sea area contains a greatly abundant wealth potential, both as a food source and as an energy source. However, the knowledge and sea utilization in this republic are still limited. Fourteen centuries ago, when the Qoran was come down in the middle of the desert, it had given guidance to human beings to make use of the sea and its whole contents. "And He is the God (read: Allah) who has makes the ocean to be down for you so that you can eat fresh meat (fish) from the sea, you issue the ornaments you wear from the sea, and you see the ship sailing on it so that you look for the fortune from His bestow and so that you thank God" (QS An-Nahl (16): 14).

[5] The ecolinguistic study is an interdisciplinary study that attributes ecology and linguistic initiated in the 1970s when Einar Haugan (1972) created the paradigm of "language ecology". In the perspectives of Haugean, language ecology is the study of language and its environment. In this context, Haugean uses the concept of language environment metaphorically, namely, the environment is seen as the language user community as one of the language codes. Language is just in its user's mind, and because its language functions if it is used to relate interuser, and attributes the user and environment, both social environment and natural environment. Thus, language ecology is determined by the person learning, using, and conveying the language to the other persons.

[6] Two decades after the paradigm of language ecology is created, the term ecolinguistics appears when Halliday (1990) at the conference of AILA elaborated the elements in language system that is regarded to be ecologic and in ecologic. It is different from Haugen, Halliday uses the ecologic concept in non-metaphoric concept, namely ecology as the biological environment. Halliday criticizes how a language system is influential to the behavior of its user in managing the environment. In his writing entitled "New Ways of Meaning", Halliday (1990) explained that language and environment denote two interplay things. The language change both in terms of lexicon and in terms of grammatical cannot be separated from the change of natural

and socio-cultural environment of the society. On one hand, the change of environment has an impact on the change of language, on the other hand, the behavior of society towards the environment is affected by the language which they use. [7] The study towards dialectical relation between language and its environment has resulted in the research topics under ecolinguistics and since then, the scope of concept application of ecology in linguistic developed very fast in the light of pragmatics, discourse analysis, anthropolinguistics, theoretical linguistics, language teaching, and a variety of other linguistics branches.

[7] In 1970, Haugen for the first time introduced the term of the ecology of language. Haugen elaborated “ecology of language may be defined as the study of interactions between any given language and its environment”. Language ecology in the quotation above can be defined as a study on interaction or reciprocal relations between a certain language and its environment. Haugen affirmed that language is in the mind of its user and language functions in the relationship between its user and environment each other, namely social and natural environment [5]. Stated that ecolinguistics has something to do with ten scopes of studies, i.e.: (1) comparative historical linguistics; (2) demographic linguistics; (3) sociolinguistics; (4) diachronology; (5) dialectology; (6) philology; (7) prescriptive linguistics; (8) geopolitics; (9) ethnolinguistics, anthropolinguistics or cultural linguistics; and (10) topology of languages in an environment (see also [8,9]).

[10]By the division of Haugen mentioned above, this research has something to do with the study of sociolinguistics and prescriptive linguistics (lexicography). In the scope of ecolinguistics, the language that lives and is used to describe and represent (representing in a verbal-symbolic manner) reality in the environment either the physical environment or human-made environment (socio-cultural environment). It implies that language undergoes the change that is in line with its physical and social environment, as that the language change represents ecological change.” The process of change in the language runs gradually over a long period, without being realized by the user, and cannot be avoided.

[7] The change in the language can be observed clearly on the lexicon level. The reason is that the completeness of lexicon from a language reflects a majority of physical environment characters and socio-cultural characteristics of its user community. Conclude as follows. It is the vocabulary of a language that most clearly reflects the

physical and social environment of its speakers. The complete vocabulary of a language may indeed be looked upon as a complex inventory of all the ideas, interests, and occupations that take up the attention of the community, and was such a complete thesaurus of the language of a given tribe at our disposal, we might to a large extent infer the character of the physical environment and the characteristics of the culture of the people making use of it. It is not difficult to find examples of languages whose vocabulary thus bears the stamp of the physical environment in which the speakers are placed.

## **Results and Discussions**

Based on the result of research of the sustainability extent of Bungku language for every respondent can be explained as follows.

1. Respondent 1 from 200 eco-lexicons proposed can know the meaning of eco-lexicon as many as 150 with the percentage 75%, while 50 eco-lexicons with the percentage 25% cannot know the meaning of maritime eco-lexicon of Bungku language.
2. Respondent 2 from 200 eco-lexicons proposed can know its meaning and use eco-lexicon 129 with the percentage 64.5%, while 71 with percentage 35.5% cannot know the meaning and uses maritime eco-lexicon of Bungku language.
3. Respondent 3 from 200 eco-lexicons proposed, can know the meaning and use eco-lexicon 104 with the percentage 52%, while 96 with the percentage 48% cannot know the meaning and use maritime eco-lexicon of Bungku language.
4. Respondent 4 from 200 eco-lexicon proposed can know the meaning and use eco-lexicon 97 with the percentage 48.5%, whereas 103 with the percentage 51.5% cannot know the meaning and use maritime eco-lexicon of Bungku language.
5. Respondent 5 and 32 from 200 eco-lexicons proposed can know the meaning and use eco-lexicon 86 with the percentage 43%, whereas 114 with the percentage 57% cannot know the meaning and use maritime eco-lexicon of Bungku language.
6. Respondents 6 and 46 from 200 eco-lexicons proposed can know the meaning and use eco-lexicon 76 with the percentage 38%, while 124 with the percentage 62% cannot know the meaning and use maritime eco-lexicon of Bungku language.
7. Respondent 7 and 8 from 200 eco-lexicons proposed can know the meaning and use eco-lexicon 75 with the percentage 37.5%, while 125 with the percentage 62.5% cannot know the meaning and use maritime eco-lexicon of Bungku language.

8. Respondent 9 and 30 from 200 eco-lexicons proposed can know the meaning and use eco-lexicon 54 with the percentage 27%, while 146 with the percentage 73% cannot know the meaning and use maritime eco-lexicon of Bungku language.
9. Respondents 10 and 38 from 200 eco-lexicons proposed can know the meaning and use eco-lexicon 47 with the percentage 23.5%, while 153 with the percentage 76.5% cannot know the meaning and use maritime eco-lexicon of Bungku language.
10. Respondents 11, 39, and 41 from 200 eco-lexicons proposed can know the meaning and use eco-lexicon 58 with the percentage 29%, while 142 with the percentage 71% cannot know the meaning and use maritime eco-lexicon of Bungku language.
11. Respondent 12 and 21 from 200 eco-lexicons proposed can know the meaning and use eco-lexicon 59 with the percentage 29.5%, while 141 with the percentage 70.5% cannot know and use maritime eco-lexicon of Bungku language.
12. Respondent 13, 19, 40, and 44 from 200 eco-lexicons proposed can know the meaning and use eco-lexicon 65 with the percentage 32.5%, while 135 with the percentage 67.5% cannot know the meaning and use maritime eco-lexicon of Bungku language.
13. Respondent 14 from 200 eco-lexicons proposed can know the meaning and use eco-lexicon 68 with the percentage 34%, while 132 with the percentage 66% cannot know the meaning and use maritime eco-lexicon of Bungku language.
14. Respondent 15 from 200 eco-lexicons proposed can know the meaning and use eco-lexicon 49 with the percentage 24.5%, while 151 with the percentage 75.5% cannot know the meaning and use maritime eco-lexicon of Bungku language.
15. Respondent 16 from 200 eco-lexicons proposed can know the meaning and use eco-lexicon 56 with the percentage 28%, while 144 with the percentage 72% cannot know the meaning and use maritime eco-lexicon of Bungku language.
16. Respondent 17 from 200 eco-lexicons proposed can know the meaning and use eco-lexicon 39 by percentage 19.5%, while 161 with the percentage 80.5% cannot know the meaning and use maritime eco-lexicon of Bungku language.
17. Respondent 18 from 200 eco-lexicons proposed can know the meaning and use eco-lexicon 45 with the percentage 22.5%, while 155 with the percentage 77.5% cannot know the meaning and use maritime eco-lexicon of Bungku language.

18. Respondent 20 and 29 from 200 eco-lexicons proposed can know the meaning and use eco-lexicon 34 with the percentage 17%, while 166 with the percentage 83% cannot know the meaning and use maritime eco-lexicon of Bungku language.
19. Respondent 22 and 42 from 200 eco-lexicons proposed can know the meaning and use eco-lexicon 66 with the percentage 33%, while 134 with the percentage 67% cannot know the meaning and use maritime eco-lexicon of Bungku language.
20. Respondent 23 from 200 eco-lexicons proposed can know the meaning and use eco-lexicon 61 with the percentage 30.5%, while 139 with the percentage 69.5% cannot know the meaning and use maritime eco-lexicon of Bungku language.
21. Respondent 24 from 200 eco-lexicons proposed can know the meaning and use eco-lexicon, 24 with the percentage 12%, while 176 with the percentage 88% cannot know the meaning and use maritime eco-lexicon of Bungku language.
22. Respondent 25, 26, and 37 from 200 eco-lexicons proposed can know the meaning and use eco-lexicon 63 by percentage 31.5%, while 137 with the percentage 68.5% cannot know the meaning and use maritime eco-lexicon of Bungku language.
23. Respondent 27 from 200 eco-lexicons proposed can know the meaning and use eco-lexicon 57 with the percentage 28.5%, while 143 with the percentage 71.5% cannot know the meaning and use maritime eco-lexicon of Bungku language.
24. Respondent 28 from 200 eco-lexicons proposed can know the meaning and use eco-lexicon 44 with the percentage 22%, whereas 156 with the percentage 78% cannot know the meaning and use maritime eco-lexicon of Bungku language.
25. Respondent 31 and 43 from 200 eco-lexicons proposed can know the meaning and use eco-lexicon 127 with the percentage 63.5%, while 73 with the percentage 36.5% cannot know the meaning and use maritime eco-lexicon of Bungku language.
26. Respondent 33 and 36 from 200 eco-lexicons proposed can know the meaning and use eco-lexicon 46 with the percentage 23%, whereas 154 with the percentage 77% cannot know the meaning and use maritime eco-lexicon of Bungku language.
27. Respondent 34 and 35 from 200 eco-lexicons proposed can know the meaning and use eco-lexicon 31 with the percentage 15.5%, while 169 with the percentage 84.5% cannot know the meaning and use maritime eco-lexicon of Bungku language.
28. Respondent 45 from 200 eco-lexicons proposed can know the

- meaning and use eco-lexicon 53 with the percentage 26.5%, whereas 147 with the percentage 73.5% cannot know the meaning and use maritime eco-lexicon of Bungku language.
29. Respondent 47 from 200 eco-lexicons proposed can know the meaning and use eco-lexicon 134 with the percentage 67%, whereas 66 with the percentage 33% cannot know the meaning and use maritime eco-lexicon of Bungku language.
  30. Respondent 48 from 200 eco-lexicons proposed can know the meaning and use eco-lexicon 30 with the percentage 15%, while 170 with the percentage 85% cannot know the meaning and use maritime eco-lexicon of Bungku language.
  31. Respondent 49 from 200 eco-lexicons proposed can know the meaning and use eco-lexicon 5 with the percentage 2.5%, whereas 195 with the percentage 97.5% cannot know the meaning and use maritime eco-lexicon of Bungku language.
  32. Respondent 50 from 200 eco-lexicons proposed can know the meaning and use eco-lexicon 135 with the percentage 67.5%, while 65 with the percentage 32.5% cannot know the meaning and use maritime eco-lexicon of Bungku language.

The above explanations showed that there is not even one respondent that dominates the 200th meaning of maritime eco-lexicon of the Bungku language. About that, there is not even one respondent that can use all of the maritime eco-lexicons of the Bungku language. Based on the result of data analysis that is collected, the 200th sustainability extent of maritime eco-lexicon of Bungku language depends on the mastery of eco-lexicon meaning had by respondents. The extent of respondents' mastery towards 200 maritime eco-lexicons of Bungku language proposed can be seen as follows:

- a. Mastery extent about 75% is one person
- b. Mastery extent about 62.5% to 67% is 5 person
- c. Mastery extent about 52% to 57.5% is 2 persons
- d. Mastery extent about 43% to 49% is 2 person
- e. Mastery extent about 30% to 38% is 16 persons
- f. Mastery extent about 22% to 29.5% is 16 persons
- g. Mastery extent about 12% to 19.5% is 7 persons
- h. Mastery extent about 2.5% is one person.

Based on the above explanation, it can be seen that the sustainability extent of the highest maritime eco-lexicon is the first respondent, namely from 200 maritime eco-lexicons proposed, the ones that are mastered are 150 eco-lexicons with the percentage of



75% and the ones that are not mastered are 50 eco-lexicons with the percentage 25%. Besides, it can also be seen that the lowest sustainability extent is on the 49th, namely from 200 eco-lexicons proposed, the ones that are mastered are solely 5 eco-lexicons with the percentage of 2.5% and the ones that are not mastered are 195 eco-lexicons with the percentage 97.5%.

From the data of sustainability extent of a respondent, it seems that the respondent that has the highest sustainability extent of maritime eco-lexicon of Bungku language is the first respondent with the sustainability extent of 75%. It means that from the 200 eco-lexicons proposed, the first respondent can know the meaning and use 150 eco-lexicons and 50 that are not known the meaning as one cannot use them in daily interaction.

## **Conclusions and Recommendations**

### **Conclusions**

Based on the result of data analysis according to the previous explanation, it can be concluded as follows:

The maritime eco-lexicon of the Bungku language is not significant to be used on young generations in this case does not survive. It is marked with many maritime eco-lexicons of Bungku language that are not known by respondents, in which from the number of 200 eco-lexicons presented to 50 respondents are found 55 maritime eco-lexicons of Bungku language whose percentage is above 50%, whereas maritime eco-lexicon of Bungku language whose percentage is under 50% is higher namely 145 eco-lexicons. Based on the result of sustainability percentage of maritime eco-lexicon of Bungku language merely reaches 27.50%, while the maritime eco-lexicon of Bungku language that does not survive reaches 72.50% so that the result of this research showed that maritime eco-lexicon of Bungku language does not survive.

### **Recommendation**

The government of Morowali Regency issues regional regulations to make the Bungku language one of the local load lessons on each educational level to survive again and again and does not undergo the extinction of being learned by the next young generations primarily on maritime eco-lexicon of Bungku language.

### **Acknowledgments**

The author appreciates Prof. Dr. Muhammad Zamrun, S.Si., M.Sc., M.Si, the Chancellor of Halu Oleo University as well as Mr. Dr.

AkhmadMarhadi, S.Sos., M.Sc. for providing the opportunity to conduct this research and Mr. La Ode Sidu for proofreading the manuscript

## References

- [1] Sofoana, Aprina Puput. 2013. Sosiologi Suatu Pengantar. Jakarta: Bina Aksara.
- [2] Sudaryono. Gregorius. 2012. Tata BahasaPraktis Bahasa Indonesia. Jakarta :Rineka Cipta.
- [3] Gunarwan, Asim. 2006. Kasus-KasusPergeseran Bahasa Daerah Akibat Persaingan dengan Bahasa Indonesia. JurnalIlmiah Masyarakat Linguistik Indonesia. Edisi 24.Nomor 1, Februari 2006.
- [4] Tahir, Musabir. 2013. Membangun Sumber Daya Kedaulatan Indonesia Berkelanjutan). Bogor : PT. Penerbit IPB Press. (Peranan Oseanografi dalam Pemanfaatan Sumber Daya Perikanan
- [5] Haugen, Einar. 1972. The Ecology of Language. Stanford, California: Stanford University Press.
- [6] Halliday , M.A.K. dan Ruqaiya Hasan. 1999. Bahasa, Konteks dan Teks: Aspek- Aspek Bahasa dalamPandanganSemiotikSosial. (Terjemahan: Asruddin Barori Toudari Judul Asli: Language, Context, and Text: Aspects of Language in a Social-Semiotic Perspective). Yogyakarta: Gadjah Mada University Press.
- [7] Fill, Alwin dan Peter Mühlhäusler. 2001. The Ecolinguistics Reader Language, Ecology and Environment. London: Continuum.
- [8] La Ino. 2018. "Survival Eco-lexicon in The Environment of Plants in Traditional Medicine Taloki Language" Dalam International Conference on Life, Innovation, Change, and Knowledge (ICLICK 2018) Advances in Social Science, Education and Humanities Research, volume 203, page 348—353
- [9] La Ino, Nirmalasari, La Ode Sidu. 2019. Metaphorical Expression on Kaghati in Muna language: Ecolinguistic Perspective. Dalam International Journal of Linguistics, Literature and Translation (IJLLT) ISSN: 2617-0299 Volume 2 nomor 1, page73-78.
- [10] La Rodi, La Yani, La Ino. "Kebertahanan Kosakata Keladangan Bahasa Ciacia Dialek Wabula Pada Anak Usia Remaja Di Desa Matanauwe Kecamatan Siotapi na Kabupaten Buton dalam jurnal Pendidikan bahasae-ISSN 2502-4183 volume 7 nomor 1

- [11] Emzir. 2010. Metodologi Penelitian Kualitatif Analisis Data. Jakarta: Rajawali Press.
- [12] Moleong, Lexy J. 2008. Metodologi Penelitian Kualitatif. Bandung: PT Remaja Rosdakarya.
- [13] La Ode Sidu, La Niampe, La Ino. 2016. "Survival vocabulary of Wuna language in plant environment of Kowaladalam International Research Journal of Management, IT & Social Sciences Available online at <https://sloap.org/journals/index.php/irjmis/> Vol. 3 No. 5, May 2016, pages: 72~81 ISSN: 2395-7492 <https://sloap.org/journals/index.php/irjmis/article/view/368> page 72--81

# Science and Interpretation of the Qur'an in Indonesia Tracing the Scientific Interpretation Pattern in At- Tanwir Muhammadiyah's Tafsir

M Nurdin Zuhdi, M. Anwar Nawawi

## Introduction

The book *Al-Jawahir fi Tafsir Al-Qur'an Al-Karim* by Tantawi Jauhari which was published in 1929 can be considered a watershed moment in the revival of scientific interpretation. Through his monumental work, Jauhari appeared to want to invite Muslims to generate scientific studies in Islamic studies, particularly in the interpretation of the Qur'an. In Indonesia, there are many interpretations of science, either written individually or institutionally. For example, *Nalar Ayat-Ayat Semesta Menjadikan Al-Qur'an Sebagai Basis Kontruksi Ilmu Pengetahuan dan Ayat-ayat Semesta Sisi-sisi al-Quran yang Terlupakan* which are both wittern by Agus Purwanto [1], [2]; *Tafsir Ilmi* by the Ministry of Religion of the Republic of Indonesia which was written in up to a dozen volumes on nature-related topics such as *Penciptaan Jagad Raya dalam Prespektif Sains dan Al-Qur'an* [3]; *Makanan dan Minuman dalam Perspektif Al-Qur'an dan Sains* [4]; *Samudra dalam Perspektif Al-Qur'an dan Sains* [5]; *Waktu dalam Perspektif Al-Qur'an dan Sains* [6]; *Penciptaan Cahaya dalam Prespektif Sains dan Al-Qur'an* [7]; *Tafsir At Tafsir* is also need to be mentioned here which was written by the Tarjih and Tajdid Council of PP Muhammadiyah [8]; and others. This last book mentioned will be the focus of the study in this research.

This paper only focuses on the last-mentioned institutional interpretation, namely *Tafsir At-Tanwir* by the Tarjih and Tajdid Council PP Muhammadiyah. Institutional interpretation is a collective interpretation written and published on behalf of a specific religious institution, and in this case the institution is Muhammadiyah. Since its initial launch on Tuesday 13 December 2016, *Tafsir At-Tanwir* has received many requests for reprint. This proves that *Tafsir At-Tanwir* is well-received by the larger community, particularly Muslims. *Tafsir At-Tanwir* has given birth to a different style of interpretation from the existing interpretations by combining three approaches, namely bayani, burhani, and irfani. One of them is the scientific interpretation pattern described in this article.

The word "At-Tanwir" is used in Tafsir At-Tanwir to describe Muhammadiyah's identity as the enlightener. This is certainly consistent with the Muhammadiyah logo, which depicts the sun illuminating the darkness. The term "at-Tanwir" means "enlightenment." Tafsir At-Tanwir is expected to provide enlightenment in the same way that the sun illuminates the earth, based on the name. Muhammadiyah is also known as a reformist-modernist or renewalist Islamic movement. The reformist-modernist character exhibits a progressive Islamic style that combines purification and development (dynamization) and is intermediate or moderate (wasathiyah), ensuring that Islam remains current and becomes a religion for civilization (din al-hadlarah) throughout the ages. [9, p. 53].

### **Tafsir At-Tanwir and the Scientific Ethos**

Tafsir At-Tanwir awakens the scientific ethos as well as the ethos of worship, economy, work, and the social ethos. The interpretation of the Qur'an that evokes the scientific ethos is one that is aimed at encouraging readers to recognize the importance of science and knowledge, as well as encouragement to master science and technology for the benefit of community development and empowerment. [8, p. x]. It is also emphasized in Tafsir At-Tanwir that the revival of Muslims is not possible without a hard struggle to master science and technology. This interpretation, which evokes a scientific ethos, can also be found in Tafsir At-Tanwir. For instance, when interpreting the 26th verse of Surah Al-Baqarah:

إِنَّ اللَّهَ لَا يَسْتَحْيِي أَنْ يَضْرِبَ مَثَلًا مَّا بَعُوضَةً فَمَا فَوْقَهَا ۚ فَأَمَّا الَّذِينَ آمَنُوا فَيَعْلَمُونَ أَنَّهُ الْحَقُّ مِنْ رَبِّهِمْ ۗ وَأَمَّا الَّذِينَ كَفَرُوا فَيَقُولُونَ مَاذَا أَرَادَ اللَّهُ بِهَذَا مَثَلًا ۗ بَصُلٌ بِهِ كَثِيرًا وَيَهْدِي بِهِ كَثِيرًا ۚ وَمَا يُضِلُّ بِهِ إِلَّا الْفَاسِقِينَ

26. Indeed, Allah is not timid to present an example - that of a mosquito or what is smaller<sup>1</sup> than it. And those who have believed know that it is the truth from their Lord. But as for those who disbelieve, they say, "What did Allah intend by this as an example?" He misleads many thereby and guides many thereby. And He misleads not except the defiantly disobedient,

In that verse, Allah wishes to illustrate the characteristics of believers and unbelievers through simple parables (amtsal), such as the female mosquito parable (ba'udlah) [8, pp. 176-177]. Tafsir At-

Tanwir appears to emphasize the scientific ethos when describing the parable of a mosquito. The author describes the description in Tafsir At-Tanwir, which demonstrates the scientific ethos as describe below

“Mosquitoes are insects that are classified into 41 genera and 3530 species. Mosquitoes have two scaly wings, a slender body, and six long legs. Mosquitoes vary in size, but rarely grow larger than 1 mm. The mouthparts of most female mosquitos form a long proboscis that penetrates mammalian skin to sucking blood. Female mosquitoes require protein in order to lay eggs. Female mosquitoes do not find protein in their food, so they seek it by sucking on humans. Male mosquitoes do not suck blood, whereas female mosquitoes do, because they do not require protein like female mosquitoes. Even the male mosquito's mouth is incapable of sucking blood. As a result, in the verse discussed, *ba'udhah* (بَعُوضَةً) refers to a female mosquito.” [8, p. 179].

Karakteristik tafsir yang membangkitkan etos keilmuan juga tampak dalam Tafsir At-Tanwir ketika menafsirkan surat Al-Baqarah ayat 30 tentang penciptaan manusia di muka bumi sebagai khalifah. Dalam uraiannya terkait sejarah manusia, Tafsir At-Tanwir membantah Teori Evolusi. Berikut kami kutibkan uraiannya: Tafsir At-Tanwir interprets the letter Al-Baqarah verse 30 about the creation of humans on earth as caliphs, and the characteristics of the interpretation that evoke the scientific ethos are also seen. Tafsir At-Tanwir refutes the Theory of Evolution in his description of human history. We are quoting the description here.:

“All of these verses about creation and its process confirm the belief that Allah created man as a species, along with other species of living beings, in a complex order. As a result, they were not formed by random and unintentional coincidences, as the Theory of Evolution claims. According to creationists (believers in the creation of the universe by God), the Cambrian layer empirically proves the truth of creation. The Cambrian layer is the oldest layer of the earth, containing fossils of living things that are estimated to be 500-550 million years old. This layer contains fossils of snails, trilobites, sponges, earthworms, jellyfish, sea urchins, and other complex invertebrates” [8, p. 203].

Penafsiran ayat ke 26 dan 30 dari surat Al-Baqarah di atas telah menunjukkan bahwa Tafsir At-Tanwir merupakan tafsir Al-Qur'an yang begitu kuat dalam memadukan sains. Tafsir seperti ini masih jarang sekali ditemukan dalam tafsir-tafsir yang lain, khususnya tafsir kelembagaan. Untuk lebih jelasnya berikut di bawah ini akan

penulis uraikan corak tafsir ilmi dalam Tafsir At-Tanwir.

The interpretation of Surah Al-Baqarah verses 26 and 30 above has demonstrated that Tafsir At-Tanwir is a very strong interpretation of the Qur'an in terms of integrating science. This type of interpretation is uncommon in other interpretations, particularly in institutional interpretations. The writer will describe the pattern of scientific interpretation in Tafsir At-Tanwir in greater detail below.

### **The Pattern of Scientific Interpretation in Tafsir At-Tanwir**

Tafsir 'Ilmi (scientific exegies) is the scientific interpretation of the Qur'an or the exploration of the Qur'an's content based on scientific theories. The verses of the Qur'an that are usually interpreted in the style of 'scientific interpretation' are the kauniyah verses (natural). Theories and approaches used in 'scientific interpretation' are theories that are not found in the Ulumul Qur'an. According to Yusuf Al-Qaradawi, afsir 'ilmi is an interpretation that employs modern scientific tools. As a result, the end result of scientific interpretation is dense with scientific and scientific nuances. [10].

The scientific style is insufficient if the interpretation is solely based on the ulumul Qur'an device. As a result, auxiliary knowledge outside of the ulumul Qur'an is required in order to interpret the verses of Kauniyah, such as chemistry, biology, physics, astronomy, geology, and others. Tafsir 'ilmi arose from the belief that the Qur'an does not contradict common sense or science. The Qur'an contains not only halal-haram or *mahdhah* and *ghairu mahdhah* worship, but also broad and deep scientific cues.

It is necessary to assist sciences outside of the ulumul Qur'an, as mentioned above, in order for scientific cues in the interpreted verse to be revealed and wisdom to be drawn. But it will not be easy. This requires specialized knowledge. As a result, not all Qur'anic interpretations can display the style of 'scientific interpretation' in their interpretation. The following is a scientific interpretation pattern in Tafsir At-Tanwir.:

### **Materials and Processes of Nature's Creation**

This interpretation of the process of universe creation is carried out when interpreting the second verse of Surah Al-Fatihah: *الْعَلَمِينَ رَبِّ إِلَهٍ الْحَمْدُ*. Only after thoroughly describing the philosophical basis of creation will the process of scientific creation of the universe be explained. This is where Tafsir At-Tanwir's scientific

interpretation' style shines through. Here is an excerpt of the interpretation:

“The creation process begins with the creation of the universe. The universe "is in a very vast roar," as Carl Sagan put it, which he dubbed the Cosmic Ocean. After Allah "provided" space for the formation of celestial bodies, Allah began to create celestial bodies with lumps of gas in the form of "fog" (dukhan, QS Fushilat [41]: 11) dense and fused (QS al-Anbiya' [21]: 30), which is now known as helium, lithium, and hydrogen. This procedure is divided into two stages (Q.S. Fushilat [41]: 12). Physicists still don't understand why these gases can gain mass and coalesce and move. It wasn't until 2012 that Peter Higgs and Francois Englert discovered a large field interacting with an atom's elementary particles, causing the atomic nucleus to gain mass. The stronger the interactions between the particles, the more mass they gain. That is the Higgs Boson, which is also known as the God particle by Leon Lederman” [8, pp. 20–21].

The quote above shows that in interpreting the 2nd verse of Surah Al-Fatihah, Tafsir At-Tanwir uses a lot of scientific terms that were previously rarely found in the interpretation of the existing commentary books. In addition, the exegetical quotations often refer to several books from the West that use English, and there are at least two books used in interpreting the second verse of Surah Al-Fatihah, entitled *Cosmos* by Carl Sagan and *The God Particle: If Universe is the Answer, What is the Question?* By Leon Lederman [11], [12]. The use of references in English in interpreting the Qur'an, especially related to science, is very rarely found in the books of interpretation that have been written by previous religious scholars.

### **Heart (*qalb*) in the Perspective of Medical Science**

The interpretation of the word "*qalb*" from the perspective of science is very interesting to put forward. The interpretation of the word "*qalb*" is found when interpreting verse 10 of Surah Al-Baqarah in Tafsir At-Tanwir Juz 1. The following is an excerpt of the interpretation:

“Arabs generally use the word "*qalb*" in the sense of the heart. So far, experts believe that the heart's electromagnetic field is the strongest field that humans have. This field does not only affect every cell in the body but also covers all directions of the surrounding space. It is suspected that the electromagnetic field is a very important carrier of information. In fact, it can also be proven that one person's electromagnetic field can affect the workings of another person's



brain. Here is an example that the heart has sight, hearing, emotions, and thoughts: a little girl is able to pinpoint the killer of a heart donor (showing clothes, weapons, and events). The transplant doctor discovers the patient who received a heart from a suicidal donor, is now afraid to kill herself. The results of recent research on the heart also indicate that the heart can hurt if thoughts and emotions are not related to the right behavior, for example, hypocritical behavior that has characteristics that deviate from universal values." [8, pp. 126–127].

The excerpt of the interpretation of the 10th verse of Surah Al-Baqarah above is very interesting and contributes to the world of interpretation of the Qur'an because so far it is rare for the interpretation of the word "*qalb*" to be explored in depth from the perspective of medical science. In addition, the interpretation also refers to the results of the latest research on the heart so that the product of interpretation is completely new. In interpreting the word "*qalb*", three books are used in English, namely Multidimensional Mind: Remote Viewing in Hyperspace by Jean Millay; Connectedness by Arnold Ward; and The Heart Speaks: A Cardiologist Reveals the Secret Language of Healing by Guarneri Erminia [13]–[15]. These kinds of interpretation products provide new insights and awaken the ethos of science for its readers.

Thus a brief description of the scientific interpretation style in Tafsir At-Tanwir. Indeed, there are still many scientific themes in Tafsir At-Tanwir that the author has not described in this article. The examples of the scientific interpretation style in Tafsir At-Tanwir that the author put forward are also very limited. This research can be said to be preliminary research, so further research is still very much needed, especially regarding the style of scientific interpretation in Tafsir At-Tanwir. Moreover, Tafsir At-Tanwir has just stepped on the first volume which has just arrived at Surah Al-Baqarah verse 141.

### **Why Tafsir At-Tanwir Gives Birth to the Pattern of Scientific Interpretation**

Tafsir At-Tanwir used three approaches, they are Bayani, Burhani, and Irfani approach. Muhammadiyah itself is familiar with these three approaches, because before being used in Tafsir at-Tanwir, Muhammadiyah in its Tarjih Decision in 2000 in Jakarta, explained that the approach in Muhammadiyah ijtihad used the Bayani, Burhani, and Irfani approaches. The Bayani approach uses sharia texts, then the Burhani approach uses science, and the Irfani

approach is based on the sensitivity of conscience and the sharpness of inner intuition.

Tafsir At-Tanwir seeks to combine the three approaches. The three approaches used in Tafsir At-Tanwir then give birth to the different interpretation characteristics when compared to the existing interpretations in general, including the prominent 'scientific interpretation' pattern. The burhani approach was used in Tafsir At-Tanwir which then gave birth to the 'scientific interpretation' style. In addition, since the beginning of the Tafsir At-Tanwir was compiled, one of its objectives was to generate an ethos of knowledge, in addition to the ethos of worship, economic ethos, work ethic, and social ethos (solidarity).

The birth of Tafsir At-Tanwir is considered important and interesting to study, considering that Tafsir At-Tanwir is an interpretation born from one of the largest and oldest Islamic organizations in Indonesia. According to Alwi Shihab, the contribution of Muhammadiyah in the thought and development of Islam in Indonesia cannot be denied because it has presented itself as a unique phenomenon in religious life in Indonesia [16, p. 4]. Tafsir At-Tanwir, which is planned to be published in 30 chapters as a whole, is a form of Muhammadiyah's response and concern for contemporary Islamic issues in Indonesia, including the development of science and technology. Thus development is intended so that Indonesia does not lag far behind other countries, because the progress of a nation is identical with the advancement of science and technology, and this is where the role of Tafsir At-Tanwir is very important and strategic.

## **Conclusion**

It is undeniable that the burhani approach used in Tafsir At-Tanwir has encouraged the birth of interpretive characteristics in Tafsir At-Tanwir. One of the characteristics that were born is to generate a scientific ethos. In the history of the interpretation of the Qur'an, especially in the Indonesian context, there are not many works of interpretation of 30 chapters that have the pattern of scientific interpretation and Tafsir At-Tanwir is one of them. Tafsir At-Tanwir has made a major contribution to the development of science. Tafsir At-Tanwir is not just a *bi 'ilmi* interpretation, an interpretation that uses science with the letter '*bi*' (with) as its slogan, but this interpretation is an interpretation that has moved and produced science with its charitable efforts in various fields, ranging from education, health, economic and social community spread throughout

Indonesia and abroad. Muhammadiyah has proven that the study of scientific interpretation in Muhammadiyah is not only in the theoretical realm, but has touched the practical-applicative realm.

## References

- [1] Agus Purwanto, *Nalar Ayat-Ayat Semesta -Menjadikan Al-Qur'an Sebagai Basis Kontruksi Ilmu Pengetahuan*. Bandung: Mizan, 2012.
- [2] Agus Purwanto, *Ayat-ayat Semesta Sisi-sisi al-Quran yang Terlupakan*. Bandung: Mizan, 2013.
- [3] Kemenag RI, *Penciptaan Jagad Raya dalam Prespektif Sains dan Al-Qur'an*. Jakarta: Lajnah Pentashihan Mushaf Al-Qur'an, 2010.
- [4] Kemenag RI, *Makanan dan Minuman dalam Perspektif Al-Qur'an dan Sains*. Jakarta: Lajnah Pentashihan Mushaf Al-Qur'an, 2013.
- [5] Kemenag RI, *Samudra dalam Perspektif Al-Qur'an dan Sains*. Jakarta: Lajnah Pentashihan Mushaf Al-Qur'an, 2013.
- [6] Kemenag RI, *Waktu dalam Perspektif Al-Qur'an dan Sains*. Jakarta: Lajnah Pentashihan Mushaf Al-Qur'an, 2013.
- [7] Kemenag RI, *Penciptaan Cahaya dalam Prespektif Sains dan Al-Qur'an*. Jakarta: Lajnah Pentashihan Mushaf Al-Qur'an, 2016.
- [8] M. T. dan T. P. P. Muhammadiyah, *Tafsir At-Tanwir Juz 1*. Yogyakarta: Majelis Tarjih dan Tajdid Pimpinan Pusat Muhammadiyah, 2016.
- [9] Haedar Nashir, *Memahami Ideologi Muhammadiyah*. Yogyakarta: Suara Muhammadiyah, 2016.
- [10] M. N. Zuhdi, "Tafsir Ilmi dalam Tafsir At-Tanwir," *Ibetimes.id*, 2020.
- [11] Carl Sagan, *Cosmos*. New York: Ballantine Books, 1980.
- [12] Leon Lederman, *The God Particle: If Universe is the Answer, what is the Question?* New York: Delta Books, 1993.
- [13] Jean Millay, *Multidimensional Mind: Remote Viewing in Hyperspace*. Berkeley: North Atlantic Books, 1999.
- [14] Arnold Ward, *Connectedness*. Viktoria: Trafford, 2003.
- [15] Guarneri Erminia, *The Heart Speaks: A Cardiologist Reveals the Secret Language of Healing*. New York: Touchstone, 2006.
- [16] A. Shihab, *Membendung Arus: Respon Gerakan Muhammadiyah terhadap Penetrasi Misi Kristen di Indonesia*. Yogyakarta: Suara Muhammadiyah, 2016.

# **Locally Community Institutional Sustainability in Environmental Isolation Faced Pandemic becomes Endemic**

Maharani, Marlinda Irwanti, Anita Ristianingrum

## **Introduction**

The Covid-19 pandemic is a test of the global health system and others system that hit Indonesia as well as the world. At the global level, the World Health Organization (WHO) notes that it is coordinating global laboratory surveillance of COVID-19 variants modeled on the established Global Influenza Surveillance and Response System (GISRS) [1]. GISRS is the system of Laboratory standards for detecting Respiratory syncytial virus (RSV) by real time Polymerase Chain Reaction (RT-PCR).

Global influenza surveillance has been conducted through WHO of GISRS since 1952. GISRS is a system fostering global confidence and trust for over half a century, through effective collaboration and sharing of viruses, data and benefits based on Member States' commitment to a global public health model. The mission of GISRS is to protect people from the threat of influenza by continuously functioning as: (i) global mechanism of surveillance, (ii) preparedness and response for seasonal, (iii) pandemic and zoonotic influenza; (iv) global platform for monitoring influenza epidemiology and disease; and (v) global alert for novel influenza viruses and other respiratory pathogens.

COVID-19 and its shelter-in-place orders have brought a welcome relief in many places from air pollution and the worsening environment. The Trends of climate change, habitat destruction, and urban pollution are still be hard to prove their role in COVID-19's spread. But there are some theories linking them. According Aaron Bernstein, MD, director of the Center for Climate, Health, and the Global Environment at Harvard, said in a conversation posted on the university's website, that this rapid dismantling of life on earth owes primarily to habitat loss, which occurs mostly from growing crops and raising livestock for people. There are losing species at a rate unknown since the dinosaurs, along with half of life on earth, went extinct 65 million years ago [2]. Aaron Bernstein's statement, MD, and the description in the Baduy region that has a local culture of environmental isolation are true.

According to [3] said that there were zero case of Covid-19 in Baduy from 20 of March 2020 to 30 of June 2021. Baduy tribe lives in a protected forest area in the village of Kenekes District Leuwidamar Lebak Banten Province, Indonesia. Baduy or Kanekes tribe is an ethnic group of indigenous peoples.



**Figure 1. The government provides counseling on the Covid-19 pandemic in Baduy region**

Baduy community is one of the tribes that isolate themselves from the outside world. In addition they also have taboo beliefs to document, especially the inhabitants of the Inner Baduy region. The amount of Baduy community are 26,000 people, representing 3,395 households who live in an area of 5.136,58 hectares in the mountainous region of South Banten [4, 5]

Nevertheless, the pandemic situation significantly improves air quality in different cities across the world, reduces GHGs emission, lessens water pollution and noise, and reduces the pressure on the tourist destinations, which may assist with the restoration of the ecological system. In addition, there are also some negative consequences of COVID-19, such as increase of medical waste, haphazard use and disposal of disinfectants, mask, and gloves; and burden of untreated wastes continuously endangering the environment [6]. This paper aims to formulate Locally Community Based Institutional Sustainability Model in Environmental Isolation to dealing with the Covid-19 pandemic and others pandemic

### **Baduy Community**

Baduy community live in Mount Kendeng in Kenekes Village, Leuwidamar District, Lebak Regency, the location is 173 km from

Jakarta. Ciboleger village is the final frontier of "modern" civilization village, and Kadu Ketug Village, is the first village of Baduy tribe. In Kadu Ketug Village, there is the white monument, which is the boundary of baduy village. The clothes worn by the Baduy tribe of men wore black clothing, black pants and dark blue headbands, or white clothing and black pants and white headbands (Figure 1). Entering the Baduy village, we will find warning boards with various prohibitions, such as: prohibited to carry weapons, prohibited to carry illegal drugs, picking fruit, prohibited to throw garbage carelessly, prohibited to use soap to bathe or wash, and other warnings.



**Figure 2. Baduy Community**

The Baduy community is divided into two groups namely Inner Baduy and Outer Baduy. The Inner Baduy are considered saints and clean. Their cleanliness and purity are considered to be directly related to the Creator. The sacred ceremony performed annually is

only followed by the inner Baduy figure. They are considered as saints who are ascetic to keep the earth, read the signs of nature and the signs of the times to maintain harmony and balance of nature. Baduy community live in the hamlets of Cibeo, Cikeusik and Cikartawana. The Baduy community in this always wear white black pants and white headbands. Baduy community in less associating with others community.

The outer Baduy community live in kaduketug, Cikadu, Kadukolot, Cisagu, Gajeboh, and others. Kampung Kaduketug is the outermost Baduy village bordering the non-Baduy village. The outer Baduy community are slightly different from the inner Baduy, they have often hung out with the outside community. They have listened to the radio, even have mobile phones. The clothes of the outer Baduy community are pants and black shirts while the headband is dark blue. There is another group, which is often called "Baduy Dangka", namely the inner Baduy community and the outer Baduy live in a village, but they live outside the village of Kenekes. Currently they live in Padawaras (Cibengkung) and Sirahdayeuh (Cihandam) Hamlets. This community served as buffers for Baduy in the influence of outside cultures.

### **Institutional Structure of Local Communities**

Baduy community have the locally institutional structure that has been lived from generation to generation. Locally Baduy community institutional adheres to the system of "Kekolotan" based on Sunda Wiwitan teachings, the system that respects "Kasepuhan" or "Kakolot" and "Karuhan" or ancestors [7], Baduy people proved to be very obedient to verbal agreements. The social structure of Baduy society is as follows:

"Puun" is the supreme leader of the Baduy community, chosen by customary deliberations, derived from the Inner Baduy tribe (from the village: Cibeo, Cikartawarna, Cikeusik). Puun in addition to the supreme leader, is also in charge of leading, mastering and implementing customs and teaching teachers "Sunda Wiwitan".

Puun was assisted by "Girang Seurat" who ran "kepuunan", especially the management of Huma Serang, (puun farm) and attended meetings with government officials when Puun was unable to attend. Baresan Salapan, Puun's maid in charge of maintaining security and order. The number in each village of Baduy as many as 9 people. Jaro adat (Jaro Tangtu), is the person chosen to handle social interests. Jaro Warega is the person chosen to handle the religion that

carries out the obligations of the Baduy community and represents it to control the state of the customary forest and the deposit forest outside Baduy. Jaro Pamerintahan is a village head-level position tasked with carrying out government duties, equivalent to the head of a village outside Baduy.

Kakolotan overtime is the person who is considered the most obedient to the teachings of religion and customs. Kakolotan overtime became a teacher and community advisor to sunda Wiwitan teachings. He also mastered the science of alternative and traditional medicine. Kokolotan is a person who was chosen because of his customary obedience and knowledge above average and became an advisor to Tangkesan. Jaro Tanggungan 12 is the person chosen by Kokolotan Lembur, Kokolotan, Tangkesan, and Puun. This person is tasked with providing legal protection to the entire Baduy community for behavior inside or outside the Baduy area that can harm others or harm others. In addition, he is tasked with providing guidance to maintain reasonable attitudes and behaviors in social life.

Tangkesan (Bapak. Kolot) is a person who is authorized to give advice to Puun. Tangkesan is a person who has the right to marry a couple who are married to baduy custom. The village head is the one chosen to lead and mobilize the entire village population in every gotong royong activity. Building physical as well as religious activities. Other positions that exist and are in the form of baduy community are the Chairman of youth who is responsible for leading the youth and Palewari who was chosen to help all activities held in the village.

The process of selecting existing positions is through a process of deliberation with various levels. In this election process, no one is allowed to run for any office. Each selected person is required to accept the duties charged to him. The deadline for this customary position is not determined by the year but there is determined by the authority of Puun, the authority of deliberation and the state of health given office or death. The customary positions are highly appreciated by the Baduy people.

To maintain order and law enforcement in the Baduy community the sanction is given to anyone who violates customary law. Light sanction in the form of advice and reprimand is given until severe punishment in the form of isolation until removed from the baduy area. The Baduy community also provides prisoners to punish Baduy people who violate rather severe mistakes.

This prisoner is a house apart from the other house. The convicted person continues to carry out daily activities but is always



supervised and advised by Jaro 12. At the end of the sentence, the convicted will be asked if he will still live in the Baduy region or opt out. If the convicted choose to remain in the Baduy region, then he must promise not to violate again. The firm stance of baduy leadership also happened in the modern country of Singapore. According Indonesian Ambassador Suryo Pratomo state, that Singapore imposes strict rules for its non-compliant citizens facing Covid-9, will be barred from entering Singapore again for life) (now exemplified by Singapore in the face of Covid-19).

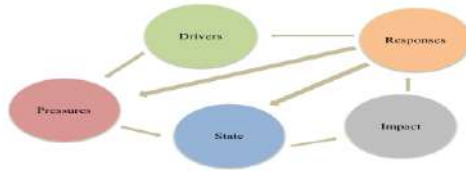
### Methodology

The research was conducted in 2019, and continued from 2020 to February 2021, and research location in Kanekes Village, Leuwidamar Sub-District, Lebak District, Banten Province.



**Picture 3. Research Location**

Identification and Inventory of indicators related to the authority, duties, functions, of institutional roles. The analysis used is the Driver-Pressure-State-Impact-Response (DPSIR) framework model (Picture 3).



**Picture 4. Driver-Pressure-State-Impact-Response (DPSIR) framework model**

The Driver-Pressure-State-Impact-Response (DPSIR) framework model has been used for integrated environmental reporting and assessment, developed by the European Environment Agency (EEA) in 1999. DPSIR has been used in environmentally related analysis in various studies [8, 9,10, 11, 12]. The output of DPSIR is indicators of the role of the Locally Community-Based Institutional in Environmental Isolation program.

Analyzing sustainability of the indicators of the role locally community-based institutional in manage of environmental isolation program. We used with Multidimensional Scaling (MDS) through Rap-Baduy software (modified Rapfish software), leverage analysis, Monte Carlo analysis. MDS method has been implemented for several studies [13, 14, 15, 16]. MDS method, is the mapping of perception relying on Euclidian Distance, with the formula:

$$d_{1,2} = \sqrt{(X_1 - X_2)^2 + (Y_1 - Y_2)^2 + (Z_1 - Z_2)^2 + \dots}$$

Description:

$d_{1,2}$  = Euclidian distance

X, Y, Z = Attributes

1,2 = Observation

Two-dimensional euclidian distance regression formula ( $\hat{D}_{1,2}$ ):

$$D_{1,2} = a + b D_{1,2} + c$$

Description:

a = intercept

b = slope

c = error

Data is sourced from the indicators of role The Locally Community-Based Institutional in Environmental Isolation (stage 1). Output in the form of index and sustainability status of role the Locally Community-Based Institutional in Environmental Isolation, and leveraged attributes. The same two points or objects are mapped in one point adjacent to each other using the ALSICAL FORTRAN algorithm techniques available in statistical devices. Rap-Baduy software in principle makes iteration, the regression process is such that it gets the smallest stress value and tries to force the intercept on the equation equals 0. For attributes as much as m, then stress is formulated in the equation:

$$stress = \sqrt{\frac{1}{m} \sum_{k=1}^m \left( \frac{\sum_i \sum_j (D_{ijk}^2 - d_{ijk}^2)^2}{\sum_i \sum_j d_{ijk}^2} \right)}$$

The magnitude of the stress value is shown in Table 1.

**Table 1. Stress values**

Number	Stress value	Conformity
1	20%	Bad
2	(10-20)%	Enough
3	(5-10)%	Good
4	(2.5-5)%	Excellent

Source: Patricia Kavanagh and Tony J. Pitcher (2004) [17]

Through the rotation method, the position of the sustainability point can be described through the horizontal and vertical axes with the sustainability index values rated 0 percent (bad) and 100 percent (good). If the system studied has a sustainability index value of > or = 50 percent, then the system is said to be sustainable, and unsustainable if the index value < 50 percent.

Formulating structural model of the role locally community-based institutional in environmental isolation, to dealing with the Covid-19 pandemic and others pandemic. We used Interpretative Structural Modeling (ISM) analysis. Interpretive structural modelling (ISM) was used to determine any mutual influences among the locally community-based institutional. Further, the ISM methodology was able to establish the level of the institutional element and determine their driving power (DP) and dependence (D). ISM methods have been widely conducted in studies such as [18, 19].

Saxena (1994) states that ISM techniques are related to the interpretation of a whole object, or system representation through

systematic and iterative application of graphic theory. ISM is a process that transforms an unlit and weak mental model into a visible system model and is clearly defined and beneficial for a variety of purposes. ISM technique is a systematic analysis of a program, so as to provide valuable value for the community in meeting the needs of the present and future. ISM methodology and techniques are divided into two parts, namely Hierarchy Preparation and Sub-element Classification. The basic principle is the identification of structures in the system that provide high value benefits in order to formulate the system effectively and for better decision making.

## Result and Discussion

### Indicators analysis

DPSIR (Drivers, Pressures, State, Impact and Response) model of intervention) is a causal framework for describing the interactions between society and the environment. Human impact on the environment and vice versa because of the interdependence of the components. As the first step, data and information on all the different elements in the DPSIR chain is collected. Then possible connections between these different elements are postulated. Through the use of the DPSIR modelling framework, it is possible to gauge the effectiveness of responses put into place (Table 2)

**Table 2. Results of identification and inventory indicators**

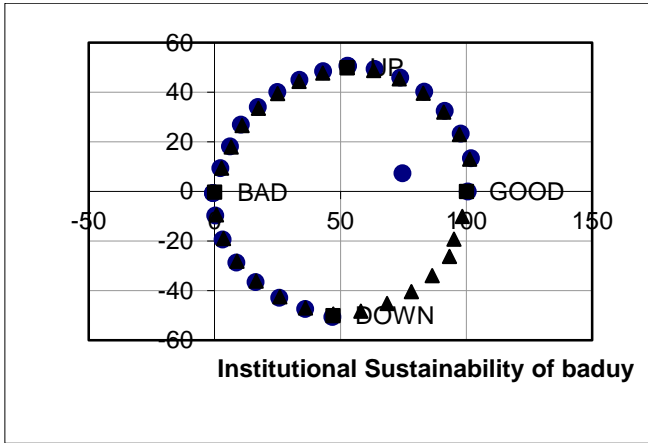
Number	Indicator	Indicator Category
1	Growing crops	Driver
2	Raising chicken	Driver
3	Fish farming	
4	Weaving (from the bark of a tree called "koja" or "jarog")	Driver
5	Habitat loss	Pressure
6	Land waste	Pressure
7	Land emission	Pressure
8	-	State
9	Potential decrease in soil carrying capacity	Impact
10	Potential decline in soil fertility	Impact
11	Socio-economic harmonization	Response
12	Socio-ecological harmonization	Response
13	ecological-economic harmonization	Response

14	Improving of social-ecological-system (SESS) or ecological-social-system (ESSs)	Response
15	Improving concept of ecological-economy system	Response
16	Improving of social-ecological-economy (sustainability)	Response
17	Competency improvement of Local Official Resources	Response
18	Increasing social interaction to others communities	Response
19	Practice of nature conservation	Response
20	To forest protection	Response
21	To maintain the continuation of the land	Response
22	The traditional agreements or traditional "laws"	Response
23	Forbidden to destroy the land	Response
24	Forbidden to deflect the flow of water	Response
25	The seeds must be from their own crops	Response

Furthermore, the response indicators of DPSIR framework model results are analyzed sustainability by MDS method, leverage analysis, and Monte Carlo analysis.

### **Sustainability Analysis**

Multidimensional scaling (MDS) the multivariate method, aims to represent input proximities among objects, such as indicators or persons, by means of fitted distances in a low-dimensional space (Figure 2). In recent years, MDS has mostly been used as a tool for analyzing proximity data of all kinds (e.g., correlations, similarity ratings, co-occurrence data). Most of all, MDS serves to visualize such data. Expert consultation results from 15 response indicators to be continue in MDS analysis,



Picture 5. Rap-Baduy Analysis Results

The results of sustainability analysis using Rap-Baduy software are 74.55% (fairly or fairly sustainable) (Table 3). Validation of Rap-Baduy simulation results shows that the coefficient of Squared Correlation (RSQ) has a high enough value of 0.96 (15 attributes included have a considerable role in explaining the diversity of locally community-based institutional). The value of S stress is 0.13 or < 0.25 which means the accuracy of the configuration of the points (goodness of fit) model built for the sustainability of locally community-based institutional

**Table 3. Index categories and sustainability status**

Number	Index Value	Category
1	00.00-24.99	Bad (unsustainable)
2	25.00-49.99	Less (less sustainable)
3	50.00-74.99	Fairly (fairly sustainable)
4	75.00-100.00	Good (sustainable)

Source: Kavanagh and Pitcher [20]

### Leverage analysis

Leverage analysis to determine the effect of stability if one of the attributes is omitted during ordination. Leverage analysis will show percent change in root mean square of each attribute (Table 4). The attributes that have the highest percentage are the most sustainability sensitive attributes [20].

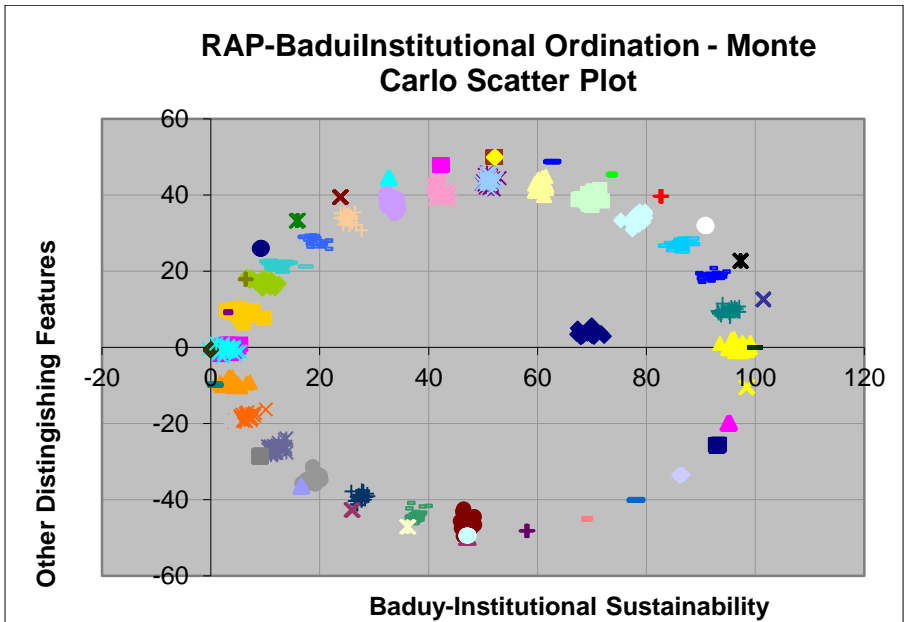
**Table 4. Attributes and Values Root Mean Square (RMS)**

<b>Number</b>	<b>Attributes</b>	<b>Root Mean Square</b>
1	The seeds must be from their own crops	3.92
2	Improving of-ecological-economy system	3.97
3	The traditional agreements or traditional "laws"	3.50
4	Practice of nature conservation	3.60
5	Socio-ecological harmonization	3.30
6	Socio-economic harmonization	3.13
7	To maintain the continuation of the land	2.90
8	ecological-economic harmonization	2.84
8	Improving of social-ecological-economy (sustainability)	3.00
10	Forbidden to deflect the flow of water	3.33
11	To forest protection	3.52
12	Forbidden to destroy the land	3.93
13	Increasing social interaction to others communities	4.26
14	Competency improvement of Local Official Resources (Girang Seurat, Puun)	4.51
15	Improving concept of ecological-economy system	3.99

The attributes that have the highest percentage are the most sustainability sensitive attributes [20].

### **Monte Carlo Analysis**

To evaluate the effect of errors on the estimation of ordination values is used Monte Carlo analysis, which is a statistical simulation method to evaluate the effect of random error on the guessing process, as well as to evaluate the actual value.



Picture 6. Monte Carlo Analysis Results

The difference in the value of MDS calculations with relatively small Monte Carlo analysis results is 0.30 ( $< 1$ ) indicates that MDS calculation results can reflect high levels of precision [20]. Formulating structural model of the role locally community-based institutional. The program, which is being studied for its structure, is divided into elements where each element is further broken down into sub-elements. For each element is done division into a number of sub-elements until it is considered adequate. Each element consists of sub-elements that have contextual relationships with each other that are defined according to the implementation in the field. According to Saxena (1992) the program can be divided into 9 elements, with its contextual relationship (Table 5).

**Table 5. Elements and Contextual Relationships in ISM techniques**

Number	Element	Contextual Relationships
1	Institutions involved with the implementation of the	its role supporting
2	Affected sectors of society	its role supporting
3	The needs of the program	support



4	Constraint	cause
5	Program objectives	contribute to the achievement of
6	Benchmarks for assessing objectives	influence on the
7	Activities needed for work planning	affect
8	Possible changes	Cause
9	Activity size to evaluate results achieved	influence on the

Based on table 4, to formulate the structural model of institutional role in environmental isolation programs, we only examine institutional elements. The results of identification and inventory of institutional elements were found as many as 14 institutional sub-elements.

The 14 institutional sub-elements consist of: (i) "Puun", is the supreme leader of Baduy society, as a teacher of teaching "Sunda-Wiwitan", tasked with leading, mastering and carrying out customs; (ii) "Tangkesan", is a person who is authorized to give advice to "Puun"; (iii) "Baresan Salapan", is "Puun" maid who is in charge of maintaining security in every village; (iv) "Girang Seurat", is Puun's Maid, runs "Kepuunan", and attends meetings with Government Officials (when "Puun" is not present); (v) "Jaro Tangtu", is the person chosen to handle social interests; (vi) "Jaro Tanggungan-12" is tasked with providing legal protection, for behavior inside or outside the Baduy area that can harm others. In addition, he is tasked with providing guidance to maintain reasonable attitudes and behaviors in social life; (vii) "Jaro Warega", is a Baduy who was chosen to handle the religion, to control the state of the customary forest and the deposit forest outside Baduy; (viii) "Jaro Danka", is Jaro Tanggungan-12's assistant; (ix) "Kakolotan Lembur", is a person who was chosen because of his adherence to customs and has above average knowledge and became an advisor to "Tangkesan"; (x) "Jaro Danka", is Jaro Tanggungan-12's assistant; (xi) "Panghulu", is Tangkesan maid, in terms of manage couples who are married to Baduy customs; (xii) "Pangwa", is Jaro Pamarentah's assistant; (xiii) "Kokolot", is Jaro Pamarentah's assistant; and (xiv) "Carik", is Jaro Pamarentah's assistant.

Based on contextual relationship considerations, the Structural Self-Interaction Matrix (SSIM) is compiled, using the symbols V, A, X and O (Table 6).

**Table 6. Aggregation results of five experts on contextual relationships between institutional elements of environmental isolation programs**

	E <sub>2</sub>	E <sub>3</sub>	E <sub>4</sub>	E <sub>5</sub>	E <sub>6</sub>	E <sub>7</sub>	E <sub>8</sub>	E <sub>9</sub>	E <sub>10</sub>	E <sub>11</sub>	E <sub>12</sub>	E <sub>13</sub>	E <sub>14</sub>
E <sub>1</sub>	A	V	A	V	V	V	V	V	V	V	V	V	V
E <sub>2</sub>		V	A	V	V	V	V	A	V	V	V	V	V
E <sub>3</sub>			A	V	V	V	V	A	V	V	V	V	V
E <sub>4</sub>				V	V	V	V	A	V	V	V	V	V
E <sub>5</sub>					V	V	V	A	V	V	V	V	V
E <sub>6</sub>						V	V	A	V	V	V	V	V
E <sub>7</sub>							V	A	V	V	V	V	V
E <sub>8</sub>								A	V	V	V	V	V
E <sub>9</sub>									V	V	V	V	V
E <sub>10</sub>										V	V	V	V
E <sub>11</sub>											V	V	V
E <sub>12</sub>												V	V
E <sub>13</sub>													V
E <sub>14</sub>													

After the SSIM is formed, the Reachability Matrix table is then created by changing V, A, X and O to the number 0 or 1.

**Table 7. Aggregation results of four VAXO ISM processing experts reachability of institutional sub-elements**

	E	E	E	E	E	E	E	E	E	E <sub>1</sub>	E <sub>1</sub>	E <sub>1</sub>	E <sub>1</sub>	E <sub>1</sub>
	1	2	3	4	5	6	7	8	9	0	1	2	3	4
E <sub>1</sub>	1	0	1	0	1	1	1	1	1	1	1	1	1	1
E <sub>2</sub>	1	1	1	0	1	1	1	1	0	1	1	1	1	1
E <sub>3</sub>	0	0	1	0	1	1	1	1	0	1	1	1	1	1
E <sub>4</sub>	1	1	1	1	1	1	1	1	0	1	1	1	1	1
E <sub>5</sub>	0	0	0	0	1	1	1	1	0	1	1	1	1	1
E <sub>6</sub>	0	0	0	0	0	1	1	1	0	1	1	1	1	1
E <sub>7</sub>	0	0	0	0	0	0	1	1	0	1	1	1	1	1
E <sub>8</sub>	0	0	0	0	0	0	0	1	0	1	1	1	1	1
E <sub>9</sub>	0	1	1	1	1	1	1	1	1	1	1	1	1	1
E <sub>1</sub>	0	0	0	0	0	0	0	0	0	1	1	1	1	1
0														
E <sub>1</sub>	0	0	0	0	0	0	0	0	0	0	1	1	1	1
1														

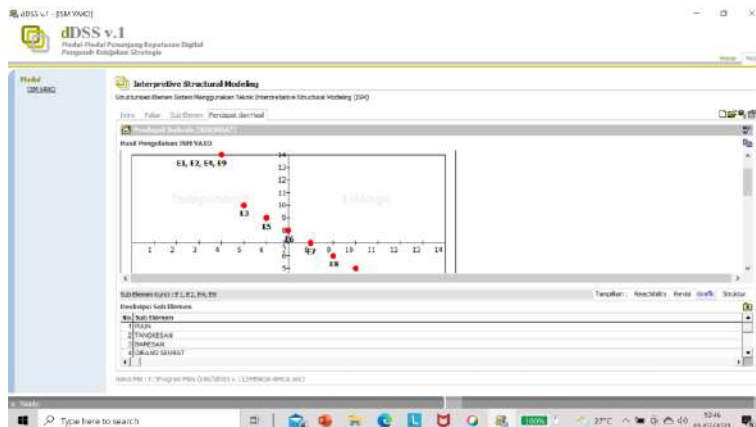
E <sub>1</sub> <sup>2</sup>	0	0	0	0	0	0	0	0	0	0	0	1	1	1
E <sub>1</sub> <sup>3</sup>	0	0	0	0	0	0	0	0	0	0	0	0	1	1
E <sub>1</sub> <sup>4</sup>	0	0	0	0	0	0	0	0	0	0	0	0	0	1

Furthermore, calculations are performed according to transitivity where corrections are made to the SSIM until a closed matrix occurs.

**Table 8. Aggregation results of four experts reachability of the final matrix of institutional elements**

	E <sub>1</sub>	E <sub>2</sub>	E <sub>3</sub>	E <sub>4</sub>	E <sub>5</sub>	E <sub>6</sub>	E <sub>7</sub>	E <sub>8</sub>	E <sub>9</sub>	E <sub>10</sub>	E <sub>11</sub>	E <sub>12</sub>	E <sub>13</sub>	E <sub>14</sub>	Drv
E <sub>1</sub>	1	1	1	1	1	1	1	1	1	1	1	1	1	1	14
E <sub>2</sub>	1	1	1	1	1	1	1	1	1	1	1	1	1	1	14
E <sub>3</sub>	0	0	1	0	1	1	1	1	0	1	1	1	1	1	10
E <sub>4</sub>	1	1	1	1	1	1	1	1	1	1	1	1	1	1	14
E <sub>5</sub>	0	0	0	0	1	1	1	1	0	1	1	1	1	1	9
E <sub>6</sub>	0	0	0	0	0	1	1	1	0	1	1	1	1	1	8
E <sub>7</sub>	0	0	0	0	0	0	1	1	0	1	1	1	1	1	7
E <sub>8</sub>	0	0	0	0	0	0	0	1	0	1	1	1	1	1	6
E <sub>9</sub>	1	1	1	1	1	1	1	1	1	1	1	1	1	1	14
E <sub>10</sub>	0	0	0	0	0	0	0	0	0	1	1	1	1	1	5
E <sub>11</sub>	0	0	0	0	0	0	0	0	0	0	1	1	1	1	4
E <sub>12</sub>	0	0	0	0	0	0	0	0	0	0	0	1	1	1	3
E <sub>13</sub>	0	0	0	0	0	0	0	0	0	0	0	0	1	1	2
E <sub>14</sub>	0	0	0	0	0	0	0	0	0	0	0	0	0	1	1
Dev	4	4	5	4	6	7	8	9	4	10	11	12	13	14	

Consistency of expert opinion by 97 percent (> 80 percent) means that the results of expert opinion are considered good. Further processing of reachability revision matrix that has fulfilled transitivity rules is the determination of level partition (Figure 6).



**Figure 7. The relationship of driver power and dependence to institutional elements in their role isolating the environment**

### Description

- E1 : “Puun”, is the supreme leader of Baduy society, as a teacher of teaching "Sunda-Wiwitan", tasked with leading, mastering and carrying out customs
- E2 : “Tangkesan”, is a person who is authorized to give advice to “Puun”.
- E3 : “Baresan Salapan”, is “Puun” maid who is in charge of maintaining security in every village.
- E4 : “Girang Seurat”, is Puun's Maid, runs "Kepuunan", and attends meetings with Government Officials (when "Puun" is not present).
- E5 : “Jaro Tangtu”, is the person chosen to handle social interests.
- E6 : “Jaro Tanggungan-12” is is tasked with providing legal protection, for behavior inside or outside the Baduy area that can harm others. In addition, he is tasked with providing guidance to maintain reasonable attitudes and behaviors in social life.
- E7 : “Jaro Warega”, is a Baduy who was chosen to handle the religion, to control the state of the customary forest and the deposit forest outside Baduy.
- E8 : “Jaro Danka”, is Jaro Tanggungan-12's assistant
- E9 : “Kakolotan Lembur”, is a person who was chosen because of his adherence to customs and has above average knowledge and became an advisor to

- “Tangkesan”
- E<sub>10</sub> : “Jaro Danka”, is Jaro Tanggungan-12's assistant
  - E<sub>11</sub> : “Panghulu”, is Tangkesan maid, in terms of manage couples who are married to Baduy customs
  - E<sub>12</sub> : “Pangwa”, is Jaro Pamarentah's assistant
  - E<sub>13</sub> : “Kokolot”, is Jaro Pamarentah's assistant
  - E<sub>14</sub> : “Carik”, is Jaro Pamarentah's assistant

The results of the ISM analysis show that the institutions that are in the independent classification are: (i) Puun, is the supreme leader of Baduy society, as a teacher of teaching "Sunda-Wiwitan", tasked with leading, mastering and carrying out customs (E<sub>1</sub>); (ii) Tangkesan, is a person who is authorized to give advice to “Puun” (E<sub>2</sub>); (iii) Girang Seurat, is Puun's Maid, runs "Kepuunan", and attends meetings with Government Officials (when "Puun" is not present) (E<sub>4</sub>); and (iv) Kakolotan Lembur, is a person who was chosen because of his adherence to customs and has above average knowledge and became an advisor to Tangkesan (E<sub>9</sub>). These 4 institutions have the highest driving power (DP) of 14 and the lowest dependency (D) of 4, so it is referred to as a key institution. Other institutions are: Baresan Salapan is "Puun" maid who is in charge of maintaining security in every village (E<sub>3</sub>); Jaro Tangtu, is the person chosen to handle social interests (E<sub>5</sub>); Jaro Tanggungan-12 is tasked with providing legal protection, for behavior inside or outside the Baduy area that can harm others. In addition, he is tasked with providing guidance to maintain reasonable attitudes and behaviors in social life (E<sub>6</sub>).

The institutions included in the dependent classification include: The institutions included in the dependent classification include: (i) Jaro Warega is a Baduy who was chosen to handle the religion, to control the state of the customary forest and the deposit forest outside Baduy (E<sub>7</sub>); Jaro Danka, is Jaro Tanggungan-12's assistant (E<sub>8</sub>); Jaro Pamarentah, is a village head-level position in charge of carrying out government duties, (the village head) (E<sub>10</sub>); Panghulu, is Tangkesan maid, in terms of managing couples who are married to Baduy customs (E<sub>11</sub>); Pangwa, is Jaro Pamarentah's assistant (E<sub>12</sub>); Kokolot, is Jaro Pamarentah's assistant (E<sub>13</sub>); and Carik, is Jaro Pamarentah's assistant (E<sub>14</sub>).

## Conclusions

The analysing of sustainability of the role of locally community-based institutional is 74.55 % (sustainable). The attribute of leverage is Baduy Human Resources capability improvement (Girang Seurat, Puun)

The formulate of locally community-based institutional structural model in environmental isolation, to dealing with the Covid-19 pandemic sustainable are: (i) The key of Institutional (The Supreme Leader, his Maid, his Advisor, and Advisor of the Supreme Leader's Advisor) have highest Driver Power and lowest Dependence; (ii) There is no institutional found on: The linkage classification, meaning that institutional Baduy society is stable; The Autonomous classification, which means that the institutional Baduy society all function in accordance with their respective authorities, duties and functions.

## References

- [1] Shobha Broor, Harry Campbell, Siddhivinayak Hirve, Siri Hague, Sandra Jackson, Ann Moen, Harish Nair, Rakhee Palekar, Soatiana Rajatonirina, Peter G Smith, Marietjie Venter, Niteen Wairagkar, Maria Zambon, Thedi Ziegler, Wenqing Zhang. 2020. Leveraging the Global Influenza Surveillance and Response System for global respiratory syncytial virus surveillance-opportunities and challenges. PubMed.gov, 14(6):622-629. doi: 10.1111/irv.12672
- [2] Joyce Frieden-MedPage. 2020. COVID-19 and the Environment: Is There a Relationship?. <https://www.medpagetoday.com/infectiousdisease/covid19/86325>. Accessed 13 July 2021
- [3] Suarabanten.id. 2021. Ramuan Anti COVID-19 Bikin Suku Baduy Bebas Corona Sampai Kini. <https://banten.suara.com/read/2021/07/05/075719/ramuan-anti-covid-19-bikin-suku-baduy-bebas-corona-sampai-kini>. Accessed 14 July 2021
- [4] Energi Bangsa. 2021. Masyarakat Suku Baduy Hebat! Tak Ada yang Terkena Corona, Begini Alasannya. <https://energibangsa.id/masyarakat-suku-baduy-hebat-tak-ada-yang-terkena-corona-begini-alasannya/>. Accessed 14 July 2021
- [5] Johan Iskandar, Budiawati S. Iskandar. 2017. BIODIVERSITAS, 18(3): 928-938

- [6] Rume Tanjena Rume and Islam S.M. Didar. 2020. Environmental effects of COVID-19 pandemic and potential strategies of sustainability. *Heliyon*. 6(9): e04965. doi: 10.1016/j.heliyon.2020.e04965
- [7] Enjang AS, Mukhlis Aliyudin, Muhibudin Wijaya Laksana, Farid Soleh Nurdin, Sitta Resmiyanti Muslimah, Widodo Dwi Ismail Azis. 2020. Sunda Wiwitan: The Belief System of Baduy Indigenous Community, Banten, Indonesia. *Jurnal Ilmiah Agama dan Sosial Budaya*, 5(1): 77-95)
- [8] Wenyan Pan, Muhammad Awais Gulzar, Waseem Hassan. 2020. Synthetic Evaluation of China's Regional Low-Carbon Economy Challenges by Driver-Pressure-State-Impact-Response Model. *Int. J. Environ. Res. Public Health* 2020, 17, 5463; doi:10.3390/ijerph17155463
- [9] Shijin Qu, Shougeng Hu, Weidong Li, Hui wang, Chuanrong Zhang, Quanfeng Li. 2020. Interaction between urban land expansion and land use policy: An analysis using the DPSIR framework. *Land Use Policy* 99(1), DOI: 10.1016/j.landusepol.2020.104856, Project: Land use/cover study
- [10] Lilis Sri Mulyawati, Luky Adrianto, Kadarwan Soewandi, and Handoko Adi Susanto. 2020. Factors of Coastal Tourism Management With DPSIR Analysis (Case Study: Tanjung Lesung Special Economic Zone, Pandeglang Regency, Banten Province, *Journal of Economic and Social of Fisheries and Marine*, 08(01): 123-137. <http://dx.doi.org/10.21776/ub.ecsofim.2020.008.01.10>,
- [11] Naveedh Ahmed S., Le Hung Anh, Petra Schneider. 2020. A DPSIR Assessment on Ecosystem Services Challenges in the Mekong Delta, Vietnam: Coping with the Impacts of Sand Mining. *Sustainability*, 12(22), 9323; <https://doi.org/10.3390/su12229323>
- [12] M. D. D. Maharani. 2021. Ecological Sustainability of Mitigation Deal with the Surge of the Covid-19 Pandemic and Other Pandemics. *Journal of Hunan University (Natural Sciences)* , 48(4): 170-176. <http://jonuns.com/index.php/journal/article/viewFile/559/556>
- [13] M. D. D. Maharani, Sumardjo, Eriyatno, Eko Sugeng Pribadi. 2017. Management Strategy For Sustainable Ruminant-Cattle Slaughterhouse (RC-S) Services. *Jurnal Veteriner*, 18(1) : 94-106

- [14] Solikhatun Nafisah, Tabah Heri Setiawan. 2019. Penerapan Analisis Multidimensional Scaling Pada Pemetaan Karakteristik Kemiskinan Di Provinsi Banten. *Jurnal Statistika dan Matematika*, 1(2): 46-59. <http://openjournal.unpam.ac.id/index.php/sm/article/view/2946>
- [15] M. D. D. Maharani and June Mellawati. 2019. Indeks Keberlanjutan Dimensi Peraturan Dalam Perencanaan Pembangunan PLTN Di Indonesia. *Jurnal Pengembangan Energi Nuklir*, 21(1): 19-24
- [16] M. D. D. Maharani and Ismaniah. 2020. The Sustainability of the Regional Government Directive Policy and Key Performance Indicator in Addressing Radicalism and Extremism in Indonesia. *Journal of Strategic Innovation and Sustainability*, 15(6): 111-116
- [17] Kavanagh, P and Pitcher T.J. 2004. Implementing Microsoft Excel Software For Rapfish: A Technique For The Rapid Appraisal Of Fisheries Status. *Fisheries Centre Research Reports*. 12(2). Vancouver (CA): University Of British Columbia
- [18] Robert O. Walton; Aman Gupta; Ronald R. Mau. 2021. Interpretive structural modelling approach to assess financial attributes of the air cargo industry. *International Journal of Logistics Systems and Management*, 38(1):30 – 44;
- [19] Wendra G. Rohmah, S. Asmaul Mustaniroh, Panji Deoranto, D. A. Nharawasthu. 2019. An Interpretive Structural Modelling (ISM) Approach for Institutional Analysis of Gadung Yam (*Dioscorea Hispida* Dennst) Chips Supply Chain in SMEs Tulungagung, East Java, Indonesia. *Journal of Management, Economics, and Industrial Organization*, 3(3): 27-45
- [20] Kavanagh, P. and Pitcher, T.J., 2004. Implementing Microsoft Excel Software of Rapfish: A Technique for the Rapid Appraisal of Fisheries Status. University of British Columbia



## **Development Of Teaching Materials Based On Mathematical Reasoning To Improve Mathematical Ability**

Maifalinda Fatra, Lilis Marina Angraini

### **Introduction**

Students need to have good mathematical reasoning ability [1]–[3]. Reasoning ability is the ability to analyze various problems presented in learning. Students in solving problems need logical thoughts and lines of thought so that problems can be solved properly and optimally. Students also need to have good reasoning ability. Good reasoning skills can lead students to have good thinking skills. In other words, the reasoning ability is a process carried out by students in analyzing a problem so that they can reach the correct conclusion based on their observations. Good reasoning followed by good communication will lead students as prospective teachers to become qualified and professional educators.

Based on several studies, there are still many low mathematical reasoning abilities in Indonesia [4]–[8]. Likewise, during the teaching at the Primary Teacher Education Study Program for the last 2 years, there were still many students whose mathematical reasoning ability was weak. This could be seen during learning process and the final results of their mathematics courses. Often it was found that students had difficulty in communicating their ideas, difficulty in analyzing the concepts contained in the questions given which often led to reluctance to work on the questions given. Moreover, there was lack of excitement apparent in them resulting in tendency to work on questions as they barely could without attempting to discuss or looking for other references so that they could understand better.

Teaching materials are one of the solutions considered to enable overcoming the problems mentioned above because teaching materials allow them to have a clear and well-structured guidance. Moreover, the teaching materials provided are also adjusted to the problems they encounter, specifically teaching materials that are designed based on mathematical reasoning. Thus, teaching materials designed based on mathematical reasoning are expected to have a positive effect on students' mathematical reasoning ability [9].

Research on the development of teaching materials based on mathematical reasoning has been conducted by several researchers. However, the development of teaching materials based on

mathematical reasoning carried out here is made based on the analysis of learning difficulties experienced by students, and the teaching materials made also look at the Initial Mathematical Ability factor. Initial Mathematical Ability is also seen in this study because Initial Mathematical Ability can be used as a determining factor in differentiating the ability of students [10], [11].

Students who have good Initial Mathematical Ability usually also have good mathematical ability. Therefore, the Initial Mathematical Ability factor becomes important to be linked in seeing the achievement of students' mathematical reasoning. In this context, research on the development of teaching materials has been widely reported. However, research on the development of teaching materials based on reasoning by considering Initial Mathematical Ability as a determining factor is rather new in the world of research, especially in mathematics education research. Initial Mathematical Ability is one of the factors that can distinguish mathematical reasoning ability, because logically children who have good early mathematical ability should have good reasoning ability as well.

This study compares conventional learning and learning that uses teaching materials based on mathematical reasoning during online learning. Conventional learning is learning that emphasizes lectures, the lecturer explains the material via zoom, google meet or other media, then ends with practice questions about the material studied that day. Learning that uses teaching materials based on mathematical reasoning is learning that uses student worksheets, where the worksheets have been arranged based on stages that emphasize activities that can improve mathematical reasoning ability. Lecturers guide students to work on the worksheets scientifically and this learning process also ends with practice questions that emphasize mathematical reasoning ability.

Mathematical reasoning ability is the ability to rationalize or the ability to think by connecting the facts found and then drawing conclusions based on these facts [12]. Reasoning ability is a person's ability to reach a conclusion based on the premises obtained. Based on the above opinion it can be concluded that reasoning skills need to be possessed by students because with good reasoning ability, students can carry out proper thinking processes, with the right thinking processes students will also be able to make the right conclusions [13], [14]. The conclusion is that mathematical reasoning ability is the ability to connect existing facts to reach a conclusion, mathematical reasoning ability is an ability that can be developed

through continuous practice.

This research will also look at the Initial Mathematical Ability factor. Based on teaching experience so far, Initial Mathematical Ability can distinguish a person's mathematical improvement, for this reason, through this reasoning-based teaching materials, the achievement of students' mathematical ability based on Initial Mathematical Ability will also be discussed. The purpose of this research is to develop teaching materials based on mathematical reasoning. Furthermore, in the future, this mathematical reasoning-based teaching materials will be compiled into a textbook that can help Primary Teacher Education Study Program students understand mathematics materials in Elementary Mathematics Basic Concepts course.

This research was conducted on Primary Teacher Education Study Program students who took the Elementary Mathematics Basic Concepts course for the 2020/2021 academic year. The location was determined based on the source of the problem, which the researcher found was based on his teaching experience. While the class assignment was selected based on random class, 2 classes were selected as the research class, 1 class as the experimental class and 1 class as the control class. To obtain research data, this study uses a test to measure mathematical reasoning ability. This research uses pretest-posttest. Pretest aims to see their initial mathematical ability, while post-test aims to see their final reasoning ability. This study consisted of 2 classes; the class that received learning using reasoning-based teaching materials was called the experimental class [15]. Classes that receive conventional learning are referred to as control classes.

After obtaining data based on tests, the research data will be analyzed. 1) determination of Initial Mathematical Ability will be based on 3 categories, namely high, medium and low; 2) the test instrument data will be analyzed for normality and homogeneity; 3) if the normality and homogeneity assumptions are fulfilled, a 2-way ANOVA test will be carried out; 4) if the assumption test is not fulfilled, a nonparametric test will be carried out instead of the 2-way ANOVA test, in this case, it is called the Adjusted Rank Transform Test. The reasoning ability referred to in this study are (1) Ability to make new rules; (2) Ability to use concepts to solve problems; (3) The ability to determine the relationship between concepts [16], [17]

## **Discussion**

Students' Initial Mathematical Ability consists of three categories, namely: high category, medium category, and low category. Initial Mathematical Ability data were collected and analyzed to determine students' initial mathematical ability before this research was carried out. The results of Initial Mathematical Ability were used as initial mathematical ability data, then grouped according to high, medium, and low initial ability categories.

**Table 1. Distribution of Research Sample**

Initial Mathematical Ability	Control	Experiment	Amount
High	10	10	20
Medium	10	10	20
Low	10	10	20
Amount	30	30	60

Statistical analysis of the test results using SPSS includes the Kolmogorov-Smirnov normality test, the Levene homogeneity test, and the two-way ANOVA test. Before carrying out the statistical test, first, the assumption test is carried out, namely the data normality test and the variance homogeneity test.

**Table 2. Normality Test**

	<i>Kolmogorov Smirnov</i>	<i>p-value</i>
Experiment		0,172
Control		0,153

From table 2 it is obtained that the p-value (Asymp Sig) of the experimental class is  $0.172 > 0.05 = \alpha$ , and the p-value (Asymp Sig) of the control class is  $0.153 > 0.05 = \alpha$ , then  $H_0$  is accepted. So it can be concluded that the mathematical reasoning ability of experimental class students and control class students are normally distributed at the significance level  $\alpha = 0.05$ .

**Table 3. Homogeneity Test**

<i>Statistic</i>	<i>Levene</i>
	<i>p-value</i>
0,957	
	0,332

From table 3, it is obtained that the Levene Statistic (F) value is 0.957 with a significance value of 0.332. The significance value is greater than the significance level  $\alpha = 0.05$ , so it can be concluded that  $H_0$  is accepted. That is, the two learning groups have homogeneous variances.

**Table 4. Anova Test**

<b>Anova Test</b>	<b><i>p-value</i></b>
Learning	0,708
Initial Mathematical Ability	0,001
Interaction	0,015

From table 4, it is obtained (a) the achievement of mathematical reasoning ability of students who received teaching materials based on mathematical reasoning was not better than students who received conventional learning as a whole; (b) The achievement of students' mathematical reasoning ability who received teaching materials based on mathematical reasoning was better than students who received conventional learning based on Initial Mathematical Ability; (c) there is an interaction between the learning used and the initial mathematical ability on the achievement of students' mathematical reasoning ability.

Based on the data analysis presented, the following describes a discussion of the results of the research which includes students' mathematical reasoning ability towards learning mathematics in the experimental class and the control class. Related to the mathematical reasoning ability of the two learning groups, the following will describe the learning process and the results of the mathematical reasoning ability tests of the two learning groups. During the learning process, several things become obstacles in learning both in the experimental class and in the control class. These obstacles occur due to learning that is taking place online. These constraints are: (1) The

large number of students living in home locations that are not covered by the internet network, including constraints on the internet quota for some students, and accompanied by unsupportive devices; (2) dominant learning has not been interactive, the effect of network constraints is sometimes problematic; (3) Student character or behaviour is difficult to monitor; (4) The learning tends to be online assignments, (5) Students' assignments during online learning are piled up; (6) Absorption of learning materials is minimal.

Most of the students are in rural areas, where the internet network is not smooth, so there are often problems with network interruptions when attending lectures. Very few students do not have a problem with the internet network because they are in urban areas that have adequate internet network quality.

Another obstacle is the frequent power outages at their premises during the hours they are taking online lectures, thus disrupting the ongoing learning process. Also, because students have been accustomed to getting explanations directly from lecturers, but with online learning, they cannot always get direct explanations due to certain constraints, so the materials are also not well absorbed. Students admitted that it is more difficult to understand the subject matter with online lectures compared to face- to-face lectures. Students complained about the lack of opportunities for a direct and free discussion with their lecturers, due to the limited features and quality of the internet network. Most students discussed using the comments column or chatting with text, so many contexts could not be conveyed well. Some students also complained about the increase in the fees of internet service spent every month, while family income tended to decline during the pandemic.

The constraints experienced during online learning above are also factors that affect the results of the research obtained, the above constraints cannot be ignored, because these constraints have a considerable influence during learning. For this reason, based on the results of the study, it was found that learning did not make a difference in students' mathematical reasoning ability. However, the Initial Mathematical Ability factor has a significant influence on online learning, so there are differences in the achievement of mathematical reasoning ability between students taught using mathematical reasoning-based teaching materials and students taught using conventional learning. On the other hand, in terms of the interaction between learning used and Initial Mathematical Ability, it also influences the terms of students' mathematical reasoning ability.

## Conclusion

Based on the results of the research and discussion above, the following conclusions can be drawn: (a) There is no difference in the achievement of mathematical reasoning ability between students who receive teaching materials based on mathematical reasoning and students who receive conventional learning as a whole; (b) There are differences in the achievement of mathematical reasoning ability of students who receive teaching materials based on mathematical reasoning with students who receive conventional learning based on Initial Mathematical Ability; (c) There is an interaction between the learning used and the initial mathematical ability on the achievement of students' mathematical reasoning ability.

## References

- [1] S. Retnowati and D. Agustin, "Eksperimentasi Model Pembelajaran SSCS Terhadap Kemampuan Disposisi Matematis Dan Prestasi Belajar Matematika," *J. Pembelajaran Mat.*, 2018, [Online]. Available: <https://jurnal.uns.ac.id/jpm/article/view/26030>.
- [2] D. M. Putri and Y. Destania, "Pengembangan soal penalaran matematis siswa pada materi peluang," *Alifmatika J. Pendidik. dan Pembelajaran Mat.*, vol. 2, no. 2, pp. 169–184, 2020, doi: 10.35316/alifmatika.2020.v2i2.169-184.
- [3] A. V. Cut Morina Zubainur, Raudhatul Jannah, Syahjuzar, "Kemampuan penalaran matematis siswa melalui model discovery learning di sekolah menengah Aceh," *J. Serambi Ilmu J. Sci. Inf. Educ. Creat.*, vol. 21, pp. 98–112, 2021.
- [4] N. Nuralam and M. Maulidayani, "Capaian kemampuan penalaran matematis siswa dengan model AIR," *Numeracy*, vol. 7, no. 1, pp. 35–48, 2020, doi: 10.46244/numeracy.v7i1.997.
- [5] N. Wanti, J. Juariah, E. Farlina, R. Kariadinata, and H. Sugilar, "Pembelajaran induktif pada kemampuan penalaran matematis dan self-regulated learning siswa," *J. Anal.*, vol. 3, no. 1, pp. 56–69, 2017, doi: 10.15575/ja.v3i1.1497.
- [6] I. Octriana, R. I. I. Putri, and N. Nurjannah, "Penalaran matematis siswa dalam pembelajaran ola bilangan menggunakan PMRI dan LSLC," *J. Pendidik. Mat.*, vol. 13, no. 2, pp. 131–142, 2019, doi: 10.22342/jpm.13.2.6714.131-142.
- [7] P. Endrawati and Ramlah, "Analisis kemampuan penalaran

- matematis pada materi peluang ditinjau dari kemampuan awal siswa," *Maju*, vol. 8, no. 2, pp. 148–158, 2021, [Online]. Available: <https://ejournal.stkipbbm.ac.id/index.php/mtk/article/view/712>.
- [8] D. K. Putri, J. Sulianto, and M. Azizah, "Kemampuan penalaran matematis ditinjau dari kemampuan pemecahan masalah," *Int. J. ...*, pp. 351–357, 2019, [Online]. Available: <https://ejournal.undiksha.ac.id/index.php/IJEE/article/view/19497>.
- [9] A. S. Pamungkas and Y. Yuhana, "Pengembangan pahan ajar untuk meningkatkan kemampuan penalaran calon guru matematika," *Jppm*, vol. 9, no. 2, pp. 177–182, 2016.
- [10] E. Ardhiyanti, S. Sutriyono, and F. W. Pratama, "Deskripsi kemampuan penalaran siswa dalam pemecahan masalah matematika pada materi aritmatika sosial," *J. Cendekia J. Pendidik. Mat.*, vol. 3, no. 1, pp. 90–103, 2019, doi: 10.31004/cendekia.v3i1.82.
- [11] S. Sunardi, D. Kurniati, T. Sugiarti, E. Yudianto, and ..., *Pengembangan Indikator 4c's yang Selaras dengan Kurikulum 2013 pada Mata Pelajaran Matematika SMA/MA Kelas X Semester 1*. repository.unej.ac.id, 2017.
- [12] N. P. Loc and B. P. Uyen, "Using analogy in teaching mathematics: an investigation of mathematics education students in school of education- Can Tho university," *Int. J. Educ. Res.*, vol. 2, no. 7, pp. 91–98, 2014.
- [13] A. N. Hanifah, N. Sa'adah, and ..., "Hubungan kemampuan penalaran matematis dan motivasi belajar siswa smk melalui model pembelajaran hypnoteaching," *Teorema Teor. dan Ris. Mat. Ris. Mat.*, pp. 121–129, 2019, [Online]. Available: <https://jurnal.unigal.ac.id/index.php/teorema/article/view/2692>.
- [14] M. Konita, M. Asikin, and T. S. N. Asih, "Kemampuan penalaran matematis dalam model pembelajaran connecting, organizing, reflecting, extending (CORE)," *Pris Semin. Nas. Mat.*, pp. 611–615, 2019, [Online]. Available: <https://journal.unnes.ac.id/sju/index.php/prisma/article/view/29072>.
- [15] L. M. and K. M. Louis Cohen, *Research Methods in Education*, Eighth edi. New York: Routledge, 2018.
- [16] E. Trouche, P. Johansson, L. Hall, and H. Mercier, "The selective laziness of reasoning," *Cogn. Sci.*, vol. 40, no. 8, pp. 2122–2136,



- 2016, doi: 10.1111/cogs.12303.
- [17] L. M. Angraini, Y. S. Kusumah, and J. A. Dahlan, "The enhancement of mathematical analogical reasoning ability of university students through concept attainment model," *J. Phys. Conf. Ser.*, vol. 1013, no. 1, pp. 1–5, 2018, doi: 10.1088/1742-6596/1013/1/012111.
- [18] A. A. Sihombing and M. Fatra, "Distance Learning During the Pandemic Era : Online Learning Experiences of State Madrasah Tsanawiyah Students During Covid-19 in Indonesia," vol. 06, no. 01, pp. 95–112, 2021, doi: 10.18784/analisa.v6i01.1235.
- [19] A. M. Basar, "Problematika pembelajaran jarak jauh pada masa pandemi covid-19," *Edunesia J. Ilm. Pendidik*, vol. 2, no. 1, pp. 208–218, 2021, doi: 10.51276/edu.v2i1.112.

# **Telenursing in Schizophrenia**

Mamnuaah, Noorwahyu Trihidayati

## **Introduction**

Schizophrenia is a disease that affects about 24 million people worldwide by the 15-35 years. Although its incidence is low, its chronic structure makes it a widespread illness [1] and contributes to the global burden of illness and disability [2]. This usually occurs in late adolescence or early adulthood. In most cases, they are treatable, function productively in life, and integrate into society [1]. Treatment of schizophrenia includes psychopharmacology and psychosocial approaches [3].

Schizophrenia causes damage to patterns of thought, perception, emotion, behavior, and insight. In addition, it also has a negative impact on educational and professional performance leading to loss of ability and a heavy burden of disease. However, people with schizophrenia can maintain productive lives and can integrate into society. People with schizophrenia need coping mechanisms to cope with adversity and protect their health. In today's modern era, the use of telehealth technology is an opportunity in treating people with schizophrenia. With telehealth technology, access to health care services is easier because it is facilitated, there is social support, the cost of care decreases, and the quality of care increases [4].

Telenursing is a part of telemedicine and the most important way to achieve modern nursing care, improving quality of care and faster access to nursing care services. Tele nursing also overcomes geographic barriers focusing on patient health, long-term health, and nurse empowerment. Tele nursing provides educational opportunities, follow-up, and family support through the use of communication technologies such as telephone, short message service (SMS), e-learning tools, email, and smartphone software. A telephone is the most popular communication tool used in developed countries because of its cost-effectiveness and easy accessibility [5].

The use of telehealth as a technology in the treatment of people with schizophrenia also allows these patients to receive positive results from treatment. The use of new tools in different areas of knowledge to increase the effectiveness of processes and individual skill contributes to the development of science. As with the health sector, these resources are used scientifically. For example, it is used for telehealth issues, telemedicine, and telenursing. Telemedicine

technology requires caregivers everywhere to extend the care of those in need. Distance nursing is the strategy that enhances nursing activities and enables professionals to guide and monitor patients and groups as needed.

This telenursing facilitates access, saves time and resources, and increases opportunities for self-sufficiency. Distance nursing can accelerate the development of care and health in general by using technology and communication systems for education, research, and care. In education, a study conducted in the United States on the application of Virtual Clinical Practicum used telephone conferencing technology was used to enable real-time interaction of nursing students with patients and counselors to enable real-time communication of several kilometers between nursing students and patients and counselors. Distance nursing is a booming area, as evidenced by the growing research and research in different countries, and there is strong evidence of the benefits of its use [6].

The tools used in the telenursing strategy are mostly telephones for patient care. The purpose of telenursing is to support health care management. The use of the telephone is more dominant because the technology is easy to master, use, and more popular than other resources. In some countries, telephone response is a strategy for maximizing medical systematization and services search.

Providing care through audio calls requires a higher competence of nurses in conducting interviews because nurses have difficulty making decisions based on visual assessments. The use of cell phones also allows the exchange of information via text messages. Internet connections provide the possibility to access a variety of resources. This possibility is further enhanced by the availability of mobile phones.

Tele-nursing is booming, as evidenced by the growing research and research in different countries, and strong evidence of the benefits of using [7]. Telehealth technology that is commonly used in the care of people with schizophrenia is telephone-based practice, including periodic telephone interviews that will provide an economical alternative to encourage patients or families in treatment. Thus, the telephone can be an effective tool for providing health services. Telenursing is beneficial for evidence-based healthcare practice. Telephone Intervention Problem Solving (TIPS) is one of the telenursing interventions performed on schizophrenic patients by using telephone media and contributing to better treatment

documentation. TIPS is aimed at introducing and guiding mental health care workers. Integrate TIPS into their practice [6].

## **Discussion**

TIPS is a telecare/ telenursing practice run by Lora Humphrey Beebe, a professor of psychiatric nursing at the University of Tennessee. This practice supports solutions to solve everyday problems in patients with schizophrenia. In addition, TIPS is a program to remind health workers to offer alternative solutions and evaluate the effectiveness of these alternatives. TIPS are conducted and evaluated by phone call every week. To implement this intervention, an agreed date, and time interview was planned with the schizophrenic patient. This intervention was initiated by a TIPS practitioner nurse. Nurses use TIPS guidelines that have been compiled and followed up every week. The contents of each interview consist of topics related to the problems experienced by schizophrenic patients [6].

Three problems were identified using TIPS, namely:

### **Problem 1: Treatment difficulties**

The results of previous studies have shown that more than half of patients have problems with treatment or patient control schedules. The results of the study show that more than half of people with chronic physical illness and schizophrenia patients do not take their medication as recommended. One of the main reasons for non-adherence is forgetting to take medication. In addition, many patients were out of control either because they were forgotten or because they were restricted by transport problems. Not taking medication or being tested for follow-up appointments can exacerbate psychotic symptoms or rehospitalization. TIPS can help schizophrenic patients solve problems and can help patients find ways to remember medication schedules and control schedules and make further plans if there are transportation problems [6].

### **Problem 2: Psychiatric symptoms**

Previous studies have found that about a third of patients complain of psychiatric symptoms, despite taking the drug on a regular basis. The most common symptoms are anxiety, insomnia, and hallucinations. Many people with schizophrenia spectrum disorder (SSD) take medication on a regular basis, but they still have some symptoms. TIPS to help SSD patients go through the troubleshooting process can identify things that are helpful for treating symptoms that medication cannot control. In addition, many people with chronic

illnesses like SSD are not taking the drug as prescribed. TIPS is very important to check missed doses and promote medication compliance [6].

### **Problem 3: Interpersonal Stress**

TIPS is a specific intervention to improve medication adherence in schizophrenic patients. Therefore, TIPS is seen as a low-cost option that encourages schizophrenic patients to participate and assist in treatment. TIPS have an impact on medication adherence in schizophrenic patients. This study explains that patients with schizophrenia who participate in TIPS have a lower dropout rate compared to patients who do not follow TIPS. In addition, patients who follow TIPS are more confident in their need for treatment and medication compliance than those who do not, they can get the most out of their medication and reduce recurrence [8].

TIPS is a telenursing application that can prevent patients with schizophrenia from discontinuing medication and build belief about the importance of medication and medication compliance. Based on these findings, as mental health service decision-makers, nurses should understand the benefits of using TIPS and consider introducing TIPS into their health service. Clinical nurses should include studies related to educating people about the use of TIPS by assessing the benefit of using TIPS and the difficulties faced by schizophrenic patients. In addition, the results of this TIPS assessment can be used by policymakers as a reference to help develop mental health practices elsewhere [8].

Previous studies reported that about a third of patients experience conflict with family or people who live in the same house and this causes stress for patients. Patients with SSD were found to have poorer development of social skills than those without mental disorders. Social skills training is a complex process involving a series of group sessions, role-playing, and sometimes video recording. Such programs are outside the scope of TIPS, but some basic problems with others can be avoided through the use of a troubleshooting process. For example, different ways to communicate or deal with disagreements can be discussed during TIPS [6].

The stressor causes the problem-solving process to run. Stressors are life events (such as interpersonal conflicts) or internal processes (such as hallucinations) that are perceived as stressful to those who are experiencing them. Coping is a response to perceived stress, including both behavioral and cognitive processes. Examples

of behavioral processes include exercising, exercising in less stimulating areas, and listening to music. Examples of cognitive processes are techniques for stopping thinking, reading, or talking to supporters. People with SSD have limited ability to solve problems so it is necessary to teach certain cognitive or behavioral strategies to manage stressors. Patients with SSD who have problem-solving abilities have proven to be successful in improving community function, reducing treatment time, and increasing medication adherence [9].

After the patient receives a phone call and text messages, the patient's medication adherence is measured using the 5- point medications adherence Report Scale (MARS-D). This instrument can detect disobedient behavior. In addition to monitoring adherence to medication, telenursing can also monitor suicidal behavior in schizophrenic patients [10]. Similar to what [11] also monitored schizophrenic patients who had suicidal ideation for 3 months using the telehealth system with the result that there was a greater decrease in suicidal ideation in schizophrenic patients. Telephone interventions can also address the need for problem-solving interventions to improve medication adherence in schizophrenic patients. This TIPS has also been tested in two groups, namely examining the effect of solving the problem of adherence in the psychiatric group and non-psychiatric group for 6 months and carried out on 105 outpatient schizophrenia patients and in stable condition [12].

In Sweden, the telenursing used is not TIPS but will use Telephone advice nursing (TAN). TAN is a form of health care that provides quality care to the community, such as the Swedish Healthcare Direct (SHD) service [13]. Nurses who work in SHD services participate to share experiences and lives of SHD when providing advice to callers with mental disorders. The experience of telenursing interactions with patients and family members by telephone revealed that nurse-caller interactions were affected by several problems such as communication problems [14].

Tele-nursing help to promote primary care and improve rehabilitation and health care processes. This telenursing contributes to complementation, strengthens the integration of the medical system, and helps treat problems in chronic patients. The studies analyzed in this review, including studies from 13 countries, specifically target patients with chronic diseases, demonstrate the

importance of telecare for complete access and general coverage of the healthcare system [7].

Tele-nursing using a simple device such as a telephone makes it easier for caregivers to care for the patients and reduces daily anxiety during care. Caregivers with depressive symptoms such as: however, major depression does not improve simply by providing the information needed to care for and communicate with the patient, so professional counseling and psychotherapy services are required. Tele-nursing also reduces costs, increases access to care to advise, and increases caregiver satisfaction [15].

Tele-nursing is a modern way to promote quality of care and their families in decision making, and carefully monitor patients using all kinds of techniques. Tele-nursing includes many methods that caregivers can use for remote care, not just telephone and text messaging. About 68 million people in Iran own a smartphone and have internet access. Caregivers can take advantage of this possibility to improve caregiving [5]. Tele-nursing is one of the best ways to help patients even in rural areas and increase the level of nursing care services but is not limited to telephones. So, for better utilization of telenursing, it is recommended to use other types of technology properly. It is recommended to make the most of various mobile and internet access [5].

Tele-nursing is part of a telephone follow-up method and is primarily used for patients at high risk who are exposed to invasive procedures to lead a normal life as possible. This treatment strategy reduces the workload of traditional outpatient monitoring systems and allows specialists to focus on treating patients who really need hospitalization, reducing patient risk and readmissions for care [12]. Tele-medicine nursing can affect several factors such as interaction time, the satisfaction of the people involved in the interaction, and limitations associated with non-verbal communication, so medical professionals regarding communication, especially considered an important tool for caregivers [16].

## **Conclusion**

The application of telenursing as a technology-based intervention provides many benefits, especially in the world of health, especially mental nursing. Telenursing in patients with schizophrenia has shown that the application of telenursing, especially the TIPS application, extends the time spent by schizophrenic patients in the community, reduces the number of days of hospitalization, and

reduces relapse rates. Tele-nursing is up to date to improve quality to care and patient outcomes, reduce medical costs, reduce the need for visits, increase patient and family involvement in decision making, and closely monitor patients. It's also a method. In addition to TIPS there is TAN a type of health care that provides quality care to the community. In addition, telenursing can also serve as a monitor for patients at high risk of being exposed to invasive procedures, allowing them to lead a normal life. This treatment strategy is suitable for nursing, reduces the workload of traditional outpatient monitoring systems, focuses on patient care in the hospital, and reduces the risk of patient recurrence.

## References

- [1] World Health Organization, "Mental Health-Schizophrenia," Aug. 13, 2014. [Online]. Available: [http://www.who.int/mental\\_health/management/schizophrenia/en/](http://www.who.int/mental_health/management/schizophrenia/en/) <http://www.who.int/topics/schizophrenia/en/>
- [2] C. J. L. Murray *et al.*, "Disability-adjusted life years (DALYs) for 291 diseases and injuries in 21 regions, 1990-2010: a systematic analysis for the Global Burden of Disease Study 2010," *Lancet Lond. Engl.*, vol. 380, no. 9859, pp. 2197-2223, Dec. 2012, doi: 10.1016/S0140-6736(12)61689-4.
- [3] E. Uslu and K. Buldukoglu, "A systematic review of tele-nursing practices on schizophrenia patient care," *Turk Psikiyatri Derg. Turk. J. Psychiatry*, vol. 27, Apr. 2016.
- [4] E. Uslu, "A Telenursing Parctice For Care of People with Schizophrenia: Telephone Intervention Problem Solving," *J. Psychiatr. Nurs.*, vol. 10, pp. 131-136, Jan. 2019, doi: 10.14744/phd.2019.75768.
- [5] P. Fathizadeh, H. Heidari, R. Masoudi, M. Sedehi, and F. Khajeali, "Telenursing strategies in Iran: A narrative literature review," *Int. J. Epidemiol. Health Sci.*, vol. 1, no. 3, Oct. 2020, doi: 10.51757/IJEHS.1.3.2020.46189.
- [6] L. Beebe, K. D. Smith, and L. M. Oppizzi, "Telephone Intervention-Problem Solving (TIPS) for Schizophrenia Spectrum Disorders: Responses of Stable Outpatients Over Nine Months," *Issues Ment. Health Nurs.*, vol. 39, no. 7, pp. 561-567, Jul. 2018, doi: 10.1080/01612840.2018.1431824.
- [7] V. D. Souza-Junior, I. A. C. Mendes, A. Mazzo, and S. Godoy, "Application of telenursing in nursing practice: an integrative



- literature review," *Appl. Nurs. Res. ANR*, vol. 29, pp. 254–260, Feb. 2016, doi: 10.1016/j.apnr.2015.05.005.
- [8] E. Uslu and K. Buldukoglu, "Randomized controlled trial of the effects of nursing care based on a telephone intervention for medication adherence in schizophrenia," *Perspect. Psychiatr. Care*, vol. 56, no. 1, pp. 63–71, Jan. 2020, doi: 10.1111/ppc.12376.
- [9] U. Stentzel *et al.*, "Tecla: a telephone- and text-message based telemedical concept for patients with severe mental health disorders – study protocol for a controlled, randomized, study," *BMC Psychiatry*, vol. 15, no. 1, p. 273, Dec. 2015, doi: 10.1186/s12888-015-0659-7.
- [10] J. Kasckow *et al.*, "Telehealth Monitoring of Patients with Schizophrenia and Suicidal Ideation," *Suicide Life. Threat. Behav.*, vol. 45, no. 5, pp. 600–611, Oct. 2015, doi: 10.1111/sltb.12154.
- [11] J. Kasckow *et al.*, "Using telehealth to augment an intensive case monitoring program in veterans with schizophrenia and suicidal ideation: A pilot trial," *Psychiatry Res.*, vol. 239, pp. 111–116, May 2016, doi: 10.1016/j.psychres.2016.02.049.
- [12] M. K. Jahromi, S. Javadpour, L. Taheri, and F. Poorgholami, "Effect of Nurse-Led Telephone Follow ups (Tele-Nursing) on Depression, Anxiety and Stress in Hemodialysis Patients," *Glob. J. Health Sci.*, vol. 8, no. 3, pp. 168–173, Mar. 2016, doi: 10.5539/gjhs.v8n3p168.
- [13] A. Bjorkman and M. Salzmänn-Erikson, "When all other doors are closed: Telenurses' experiences of encountering care seekers with mental illnesses," *Int. J. Ment. Health Nurs.*, vol. 27, no. 5, pp. 1392–1400, Oct. 2018, doi: 10.1111/inm.12438.
- [14] P. Yliluoma and M. Palonen, "Telenurses' experiences of interaction with patients and family members: nurse–caller interaction via telephone," *Scand. J. Caring Sci.*, vol. 34, no. 3, pp. 675–683, Sep. 2020, doi: 10.1111/scs.12770.
- [15] M. Goudarzian, M. Fallahi-Khoshknab, A. Dalvandi, A. Delbari, and A. Biglarian, "Effect of Telenursing on Levels of Depression and Anxiety in Caregivers of Patients with Stroke: A Randomized Clinical Trial," *Iran. J. Nurs. Midwifery Res.*, vol. 23, no. 4, pp. 248–252, 2018, doi: 10.4103/ijnmr.IJNMR\_242\_16.
- [16] I. de A. Barbosa, K. C. da C. D. da Silva, V. A. da Silva, and M. J. P. da Silva, "The communication process in Telenursing: integrative review," *Rev. Bras. Enferm.*, vol. 69, no. 4, pp. 765–772, Aug. 2016, doi: 10.1590/0034-7167.2016690421i.

# **Practice speaking and social interaction for mentally retarded children through fantasy stories and role playing**

Marwiah<sup>72</sup>

## **Introduction**

The COVID-19 pandemic has greatly impacted the education system in the world, including Indonesia. The Indonesian government enforces home of work, meaning that teaching and learning activities are carried out online from home. All areas with red zone status carry out online learning. . This condition forces teachers and students to learn online, learning is packaged through digital media. Learning carried out at home does not only involve teachers and students, but parents also play a very active role in learning conditions like this [50], [51], [52]. The skills and creativity of teachers in packaging learning are very much needed [54], [55] Learning as far as possible is packaged into interesting and not boring learning for students. [56] improves English language skills during the COVID-19 pandemic by using WhatsApp and Google Classroom media. During the COVID-19 pandemic, many things and creativity need to be implemented, for example the use of children's literary literacy media in the form of fantasy stories as an effort to arouse student interest and motivation in learning. This method is expected to help mentally retarded children in improving their speaking skills and social interactions. The use of digital media literacy through children's literature can help children in the development of children's speech [53]. In addition, literary works are created to entertain, inspire, teach religious values, social values, patriotism, education and love. The implementation of online learning due to the COVID-19 pandemic has had a tremendous positive impact on teachers because teachers are motivated to learn communication technology as a whole.

After the COVID-19 pandemic, face-to-face learning resumed. Learning certainly refers to 21st century learning which is characterized by: critical thinking, communication, creativity, and collaboration (4 C). In the industrial era 4.0, information technology as the main pillar in the implementation of learning and learning

---

<sup>72</sup> Muhammadiyah University of Makassar, [marwiah@unismuh.ac.id](mailto:marwiah@unismuh.ac.id)

design in accordance with the 2013 Curriculum must apply technological, pedagogical, and konolidge content (TPACK).

Technology-based learning is learning in which one of the media is the use of internet/online-based information technology. Learning media that attract students' interest generally come from the internet/online, in this case learning children's literature is fantasy stories. Teachers are required to be able to use digital media literacy in the learning process of mentally retarded children in thematic learning systems. Therefore, literature is included in thematic learning which of course chooses children's literature/fantasy stories that integrate other learning such as science subjects, Civics, and mathematics must be relevant to the chosen fantasy story.

The number of Extraordinary Schools in the Province of Southeast Sulawesi, the Republic of Indonesia is 75 schools, 17 schools are public schools and 58 others are private schools. The number of students with special needs / extraordinary children is 2866 students, children with intellectual disabilities are 1000 students and the rest are other children with disabilities. Data of these students both in the inclusion school and those who study at an Extraordinary School. The student data includes students sitting in elementary schools, junior high schools, and senior high schools.

Looking at the educational data of children with special needs above, of course, it is inseparable from the problems facing the world of education today, namely increasing teacher competence in terms of the use of modern technology in teaching. Teachers are expected to be able to keep abreast of developments and technological advancements in education, of course. Therefore, teachers must be able to implement and implement electronic-based learning in the learning process in their respective schools.

In this semilinear era, electronic learning (e-learning) is becoming increasingly popular in education throughout the world. Learning technology (LT) has been applied to a variety of learning environments and activities to obtain meaningful, efficient, and effective learning. LT can also be used by researchers and practitioners in the field of special education. The maximum effort to create a more inclusive school community filled with many difficulties, dilemmas and contradictions that often results in gradual reforms (Vlachou, A. (2004)) Like just the application of LT implementation should no longer be a challenge by teachers and students . the fact is that teachers still apply conventional methods that are less attractive

to students, and innovative teaching methods are still very poorly applied by special education teachers / children with disabilities.

Teachers must believe that basically, special education is the same position as education in general because special education for participants with disabilities in Indonesia has been accommodated through Government Regulation No. 72 of 1991 concerning Special Education. Education for students with disabilities is provided in three types of educational institutions, namely: Extraordinary Schools (SLB), Extraordinary Primary Schools (SDLB), and Integrated Education.

Law Number 20 of 2003 concerning the National Education System which provides a new color in the provision of education for students with disabilities. In their explanation, articles 15 and 32 states that special education is education for students with disabilities or students who have extraordinary intelligence which is held inclusively or in the form of special education units at primary and secondary education levels.

The government's effort to implement inclusive education is poured through Government Regulation (PP) Number 72 of 1991 concerning Special Education, RI Law Number 20 of 2003 concerning the National Education system for education for students with disabilities, Permendiknas number 70 of 2009 concerning Inclusive Education education for students who have abnormalities and have special intelligence and/or talent potential, as well as Circular of the Director-General of Primary and Secondary Education Management of the Ministry of National Education Number 380 / C.C6 / MN / 2003, January 20, 2003, namely: every district/city is required to hold and develop inclusive education in at least 4 (four) schools consisting of Primary School, Junior High School, Senior High School and Vocational High School.

This is relevant to world-wide efforts as expressed by [19], exclusion from public schooling, and segregation in public schools. A variety of labels, definitions, and classifications have been conceived and adapted over time to describe perceived cognition and potential [17]. More recent descriptions of disabilities emphasize the interaction between an individual and the situations in which they participate [40], [41] consistent with international definitions of disability which similarly emphasize the interaction between an individual and their environment [48] and The UN Convention on the Rights of Persons with Disabilities.

The vision of inclusive education and “a school for all” was formed early in Swedish education policy [32]. Despite this vision, in the 1950s and 1960s, some students—those considered “noneducable”—continued to be referred to institutions without opportunities for education. It was not until 1967 that all children with disabilities were granted access to schools.

Sweden and the US, several policies have been in place for many years that are consistent with the principles of normalization and inclusive education. In both countries, the movement towards inclusive practices began with the right to education for all school-aged students and was expanded with legislation delineating expectations for learning. The vision of inclusive education and “a school for all” was formed early in Swedish education policy [32].

[43] ensuring children with disabilities receive a high-quality education in an inclusive environment should be a priority of all countries. To do this, and to fulfill the goals of the Convention on the Rights of People With Disabilities (CRPD) and ensure equity for people with disabilities, systemic barriers to inclusion need to be removed. The measurement of that progress requires clear data collection, monitoring, and analysis to regularly inform policies and practices (p-279).

Referring to the facts above, that how much attention the countries in the world including Indonesia to children with disabilities so that what is meant in the goals of Indonesian education is not only intended for education in general but the goal also applies to the education of children with disabilities. The aim of education in Indonesia is "to be a man of faith and devotion to an almighty God, noble, healthy, faithful, quite creative, independent and become a democratic and responsible citizen". In the context of achieving the above national education goals, there are no exceptions for children with disabilities who are in Special Schools.

Extraordinary schools are formal educational institutions established in every district or city throughout Indonesia in the context of monitoring compulsory education for 12-year-old children. The students include children who are mentally disabled, deaf, physically challenged, and blind under education institutions and the length of education is 6 years, especially at the elementary level. Children with intellectual disabilities can be classified into three groups, namely: idiot, embryo, and debil. Considering the very important education for mentally retarded children, especially debile

children, the learning program is innovative, varied, interesting, and fun. Also, the patience and hard work of a teacher is expected.

During this time the problem faced is that they have difficulty understanding the material being taught and it is difficult to concentrate on the lesson. This is due to the interaction of teaching and learning so far using only one method that is less varied and does not pay attention to factors of intelligence, physical, and physiological factors of students. Intelligence factors and social barriers of mentally disabled children that cause learning not optimal. These conditions trigger researchers to apply the roleplay method in learning. As stated by [13]. that to overcome barriers to inclusive education / for children with special needs requires systematic handling in the fields of educator preparation, pedagogy, and policy.

The learning process of mentally retarded children requires steady preparation especially about learning methods. The learning method is very important and determines the success of the teaching and learning process. The use of appropriate learning methods and according to student conditions greatly affects student behavior to follow learning material. The role-playing/roleplay learning method is adapted from the thematic learning found in basic education in Indonesia. Indonesian learning is no exception, especially in speaking skills.

This research was conducted at an Extraordinary Elementary School in the Southeast Sulawesi Province of the Republic of Indonesia. Considering the learning methods used by the teacher so far are considered less attractive to students especially mentally retarded children who have unstable emotions, low IQ, and slow social interactions. So hopefully using this method can create fun learning. Thus the learning objectives are expected to be achieved. This study will analyze the results of learning using learning technology-based roleplay methods (LT) on improving speaking skills in social interaction in mentally retarded children.

### **Overview Characteristics and Social Interactions of Mentally Disabled Children**

Mentally disabled children are those whose intelligence is clearly below average. They experience retardation in adjusting to the environment that requires special education [1] The American Association of Mental Deficiency (AAMD) defining mental retardation children is mentally retarded showing clearly below average intellectual functions accompanied by an inability to adjust behavior

and occur during development [35]. Mentally disabled is a state of mental retardation, this condition is also known as mental retardation. Children with intellectual disabilities have IQs below the average normal child in general, thus causing their intellectual and intellectual functions disrupted which causes other problems that arise during their development. This is in line with the American Association on Mental Deficiency (AAMD, 1983) quoted by Grossman.

Meanwhile according to [1], mildly retarded children are those who are included in this group even though their intelligence and social adaptation are almost but have the ability to develop in the academic level of Junior High School and their IQ ranges from around 50 to 70 "( p-22).

The classifications used now are those proposed by AAMD [8] as follows. 1. Mild mental retardation IQ is 70 - 55 2. Moderate mental retardation IQ is 55 - 40 Severe mental retardation IQ is 40 - 25 3. Profound mental retardation (very weight) IQ 25 and below (p-43).

From the definition above, it can be concluded that a person is said to be mentally retarded if showing an intellectual function is below the average clearly accompanied by an inability to adjust behavior and occur during the development period so that for education and teaching for them it is necessary to provide special programs. As in law No. 20 of 2003 concerning the National Education system article 20 states that special education is education for students who have difficulty in following the learning process because of physical, emotional, mental, social, and / or potential for special intelligence and talents.

Children with intellectual disabilities experience obstacles in academic mastery, especially in mathematics. [1] revealed that it is undeniable that there are certain learning difficulties, which of course are also learning difficulties especially in the academic field (for example Mathematics, Natural Sciences, Language). This hall is in line with the statements of [27] that in theory the equality of mental age of mentally retarded children with normal children can be accepted very logically, but the difference is still striking. This impact is also seen in completing academic tasks in mathematics, for example, Children with intellectual disabilities are far behind normal children in the same Mental Age (MA) equality.

Mild retardation with IQ 50 - 70 which by [30] that the characteristics of mildly retarded children are that they can still learn to read, write, and count simple. With good guidance and education,

mildly mentally retarded children can in time earn an income for themselves.

Mentally retarded children are students whose social adaptation is late, but they can develop in the areas of academic learning, social adjustment, and workability. Associated with learning activities, then mentally retarded children who are educated are children who have the potential to be educated in the academic learning fields such as reading, writing, arithmetic, and the possibility of obtaining the education to a certain extent by the potential and education system needed to him. The more detailed description of mental retardation characteristics of mentally retarded children is presented by [1] as follows: mental characteristics, they tend to answer back with the same response to different questions, unable to provide criticism and limited socialization abilities; physical characteristics, for those who are retarded, in general, do not experience physical abnormalities; social and emotional characteristics, their interest in playing is more suitable to the same mental age than their chronological age; academic characteristics, their learning ability is low and slow; and the characteristics of work, which can be shown to work only they belong to mild, and in good food can learn about lessons that are "Skilled and Semi-Skilled" (p-15-16).

Characteristics of mentally retarded children are as follows: fluent in speaking, but lacking vocabulary; difficult to think abstractly; at the age of 16, children reach intelligence equivalent to a normal child of 12 years; and can still participate in learning in special schools and in public schools. The characteristics of mentally retarded children (able to train) based on their level of disability are as follows: they can hardly learn academic learning but can be trained to.

### **The Role Play method by Learning Technology (LT)**

The simulation / roleplay game is almost the same as a demonstration. But what is created is a situation or an element that is not actually. In the simulation game, the actors are competing to achieve certain goals by obeying applicable rules such as chess, miniature, soccer games [31]. In modern teaching, this technique has been widely implemented so that students act like people or in the desired circumstances. [26] suggests that simulation or roleplay is a person's behavior to act as the intended person, with the aim that the person can learn more deeply about how that person feels and does something. The advantages of simulation games / roleplay [26] suggests that simulation techniques are very good to use because they



are: please students, encouraging teachers to develop student creativity, allow experiments to take place without the need for an actual environment, reduce things that are verbal or abstract, do not require direction complicated and profound, creating interaction between students that gives the possibility of wholeness and mutual cooperation and healthy family, giving rise to positive responses from slow students / lacking in talent, giving rise to critical ways of thinking and allowed teachers to work with different levels of ability (p-22).

Some related studies are as follows: [10] conclude: The video roleplay was found to be somewhat more effective than the computer simulation in the development of helping skills. This advantage, however, is dependent upon the skills of the instructor who provides the videotape feedback.

[47]. The workshop focuses on creative methods, storytelling, and roleplay, demonstrating how giving children a voice enables them to become active participants, encouraging Children to become active ambassadors for the things that affect them [15]. The workshop will acknowledge the different viewpoints on research with young children, including relevance, reliability, validity, and ethics. This workshop thus seeks to examine how storytelling can be used to encourage the child's voice, potentially identifying news understandings about methods used to increase children's voices.

The roleplay video was found to be somewhat more effective than computer simulation in the development of helping skills. This advantage. Some related studies are as follows: however, it is dependent upon the skills of the instructor who provides the videotape feedback.

[47]. The workshop focuses on creative methods, storytelling, and roleplay, demonstrating how giving children a voice enables them to become active participants, encouraging children to become active ambassadors for the things that affect them [15]. The workshop will acknowledge the different viewpoints on research with young children, including relevance, reliability, validity, and ethics. This workshop thus seeks to examine how storytelling can be used to encourage the child's voice, potentially identifying news understandings about methods used to increase children's voices.

[49] continued. and [25] applying collaborative online in their writings concluding that skills and knowledge are best obtained in context. This helps students easily transfer learning from the classroom to "real life" and back, or information from one subject to another. Therefore this method requires that trainers and students

play nontraditional roles such as interaction and collaboration with each other in the education process. Classes eliminate physical boundaries and become a goal-oriented platform dedicated to learning. The online role-playing platform offers an environment where trainers can determine their role-playing scenarios and provide opportunities for students to apply factual knowledge and to gain experience through the digital world. The coach can determine new games or adapt and modify sample games without programming skills. Some platforms provide various means of communication in scenarios; players can communicate using multimedia discussion forums, text modules, and voice chat, as well as through multi-user video conferencing. This platform encourages participation in problem-solving, effective communication, teamwork, project management, and other soft skills such as responsibility, creativity, micro-entrepreneurship, corporate culture, and cultural awareness. They are designed to be used as an adjunct to ordinary classroom teaching and corporate training, but also allow it to be used independently of class courses.

### **Children's Literature And Fantasy Stories**

Literary works are works of art that express the existence of humanity with all its variations and twists imaginatively and creatively by using aesthetic language as the medium. Whether poetry, fiction, or drama, literary works are the result of the author's reflection on his social environment which is then expressed through beautiful language with creative and imaginative power. With creativity, taste, and intention, writers express ideas about the nature of life that is felt, lived, experienced, and through literary works as a medium of imaginative expression.

Literature learning in elementary schools must be adapted to the child's age. Literature that is taught specifically for children's literature. Children's literature is a literary work that contains aesthetic and entertainment values that can generally be reached by children aged 3-12 years and is conveyed through more mature people around them, such as parents, siblings, or teachers. [27] argues that children's literature is a reading book that is read to children that can satisfy children. Children's literature is literature that reflects the feelings and experiences of children through children's fields.

One form of children's literature is fantasy stories. The characteristics of fantasy stories include that the characters displayed are almost entirely the result of imagination, for example being able

to talk to animals, ghosts, or others. Then evil stories are always marked by conflicts between time and time, both past and future are still beyond human imagination, usually related to future life with technological sophistication and others.

### **Speaking Skills and Social Interaction**

Children with intellectual disabilities / debilitated children are mentally retarded children who are unable to attend regular school programs, but they still have abilities that can be developed through education even though the results are not optimal. The abilities developed in mentally retarded children can educate, among others: reading, writing, spelling, and arithmetic; adjust and not depend on others; simple skills for future work. Can be interpreted, mentally retarded children can mean students with intellectual disabilities who can be educated at a minimum in the fields of academic, social, and work are no exception also in Indonesian subjects. Indonesian language learning refers to the achievement of four language skills which include listening, speaking, reading, and writing. Listening and speaking skills are first gained naturally from the family environment. Therefore, the family contributes to the acquisition of children's language.

[9] constraints faced by teachers in the implementation of Indonesian language learning include four aspects including planning, implementing, evaluating results and following up. To overcome existing obstacles, the teacher tries to modify the way the delivery of material to students in the learning process. According to [16].

"Indonesian language learning has a very important role in shaping the habits, attitudes, and abilities of students for the next stage of development" (p-3). [5]. Speaking is one of the four macro skills to be developed as a means of effective communication in both first and second language learning contexts. In the English as a Foreign Language (EFL) pedagogy environment, how to increase speaking competence and confidence. It turned out that the results of this study concluded that the key to improving speech was that confidence, creativity of topics, and speaking competence.

Various attempts can be made by a teacher as a result of research [18] The most common use of Learning Technology ( LT) was computer-assisted technology (such as web-based mentoring, educational computer games, laptop computers) in special education; studies investigating the use of LT with mentally disabled students were more than those with physically disabled ones. It is expected that

the findings of this work and their implications will serve as valuable references about the use of LT with special education students. [20]. His research concluded that after the use of three methods, namely discussion, problem-solving, and role-playing in learning English the ability of students to speak significantly improved.

In distant language teaching and learning, the ability to speak is the most crucial skill since it is the undeveloped for communication [3] and it is the most difficult skill. Reference [45] stated that speaking English is the most difficult for learners. In particular, EFL learners often. Speaking is the most important and essential skill. Reference [45] stated that mastery of this skill illustrates that the speaker holds precise knowledge of the language. According to many teaching theorists, speaking skill can be developed through communicative activities which contain an information gap, a jigsaw puzzle, games, problem-solving, and Role-playing. In addition, [11] reinforced this idea that the activities that can contribution better speaking skills are free discussion and role-playing. Also, [12] stated that the language activities are important factors in teaching language for communication. Activities help create interaction in the language classroom. Additionally, communicative activities can motivate the learners and establish good relationships between the teacher and the students as well as among the students thereby encouraging a supportive environment for language learning.

## **Method**

### **Research Approach and Design**

The approach used in this research is the approach taken is a qualitative descriptive approach. This study aims to find that there is an increase in the speaking skills of students with disabilities through the media-based roleplay method of learning technology. The study was designed with the use of a test-retest design model whose tests were carried out twice, namely before and after the simulation game, two measurements. The research design can be described as follows.

T<sub>1</sub>----- X----- T<sub>2</sub>

Information

T<sub>1</sub> = Tests given before receiving treatment (Pre -Test)

X = Treatment (roleplay method based on TL)

T<sub>2</sub> = Test given after receiving treatment (Post - Test)

With a group of subjects, namely elementary school students.

Give pre-test (T1) to the subjects, to measure the role of speaking skills and social interaction before using TL-based roleplay methods; Provide treatment (X) of research subjects using the TL-based roleplay method of learning to speak and social interactions; Providing post-test (T2) to measure the role of speaking skills and social interaction before using TL-based roleplay methods; and Comparing T1 and T2 to determine how much difference is arising, as a result of using the TL-based roleplay method.

### **Data Collection Techniques**

Work performance test technique aims to determine students' speaking skills, the test is carried out twice, namely the initial test is used to measure initial ability before being given treatment, while the final test is given after giving treatment/treatment in this case the application roleplay method.in TL-based.

### **Data Analysis Technique**

To interpret the results of descriptive analysis using the following criteria:

24 - 31 is a very good category, 16-23 is a good category, 8-15 is enough category, 0 - 7 is the less category

In analyzing the test results carried out with the following formula:

$$M = \frac{\sum x}{N}$$

N Where: M = average,  $\sum x$  = Test score, N = subject (Faisal 1982).

Furthermore, to find out there is no increase in speaking skills through the media-based roleplaying method of electronic learning based on data analysis if the post-test score is greater than the free test score then there is an increase and if the free test is greater than the post-test then it is categorized as no increase. Then the significance test with paired sample t-test based on the significance value (Sig) through the SPSS output, namely: if Sig (2-tailed)  $\leq$  0.05 then H0 is rejected and Ha is accepted. if Sig (2-tailed)  $\geq$  0.05 then Ha is rejected and H0 is accepted (Santoso,2014: 265).

### **Research Instruments**

Test: the test is used to obtain data on the speaking ability of mentally retarded students who sit in elementary schools in the city of Kendari, Southeast Sulawesi Province, Indonesia. Observation Sheet: used to record data on the social interaction of retarded

children who sit in elementary schools in the city of Kendari, Southeast Sulawesi Province, Indonesia.

## Results

One of the problems faced by retarded children is the low ability to speak and social interaction of children. This problem is a serious challenge for teachers who teach primary schools for children with special needs, especially for mentally retarded children. Various strategies and methods applied by the teacher, but the results are still minimal. Therefore, this study aims to determine the effectiveness of learning technology-based roleplay methods (TL) in improving the ability to speak and social interaction of mentally retarded children.

**Table 1. Acquisition Value of the Speaking Test and Observation of Social Interactions on the Pree Test(T<sub>1</sub>)**

Respondents /class	Aspect		Average Earnings	category
	Spaek skill	Social interaction		
<b>R1/a</b>	4	5	4,5	Less
<b>R2/a</b>	4	5	4,54	Less
<b>R3/b</b>	4	5	4,5	Less
<b>R4/b</b>	4	6	5	Less
<b>R5/f</b>	7	7	7	Less
<b>R6/e</b>	7	7	7	Less
<b>R7/d</b>	5	5	5	Less
<b>R8/a</b>	4	4	4	Less
<b>R9/c</b>	5	5	5	Less
<b>R10/a</b>	4	4	4	Less
<b>R111/f</b>	7	7	7	Less
<b>R12f</b>	7	7	7	Less
<b>R13e</b>	6	6	6	Less
<b>R14f</b>	7	7	7	Less
<b>R15e</b>	6	6	6	Less
<b>R16c</b>	5	5	5	Less
<b>R17b</b>	4	4	4	Less
<b>R89c</b>	5	5	5	Less
<b>R19b</b>	4	4	4	Less
<b>R20f</b>	7	7	7	Less
<b>R21f</b>	7	7	7	Less
<b>R22e</b>	6	6	6	Less
<b>R23b</b>	4	4	4	Less
<b>R24c</b>	5	5	5	Less

R25a	4	4	4	Less
R26e	6	6	6	Less
R27f	7	7	7	Less
R28c	5	5	5	Less
R39a	4	4	4	Less
R30f	7	7	4	Less
R31d	5	6	5,5,	Less
R32e	6	6	6	Less
R33c	5	6	5,5	Less
R34e	6	7	6,5	Less
R35e	6	7	6,5	Less
R36d	5	6	5,5	Less
R37e	7	7	7	Less
R38e	7	7	7	Less
R39f	7	7	7	Less
R40e	6	7	6,5	Less
R41b	4	4	4	Less
R42b	4	4	4	Less
R43c	5	5	5	Less
R44c	4	5	4,5	Less
R45d	6	6	6	Less
R46e	6	6	6	Less
R47f	7	7	7	Less
R46f	7	7	7	Less
R49f	7	7	7	Less
R50f	7	7	7	Less
average	5,56	5,80	5,62	Less

**Table 2. Frequency Acquisition Test Scores Table Talk and Observation of Social Interaction retarded children at Pree test (T<sub>1</sub>)**

Category	Interval	Frekuensi (F)		Persentase
		Speaks	Interaction	
Very Good	24 - 31			
Good	16 - 23			
Enough	15 - 8			
Less	0 - 7	50	50	100
Sum		50	50	100

**Table 3. Results Achievements Test and observation Interaction Talking On Post Test Mentally Retarded Children (T<sub>2</sub>)**

Respondents /class	Aspetc		Average Earnings	category
	Speak skill	Social Interaction		
R1/a	4	7	5,5	Less
R2/a	5	7	6,5	Less
R3/b	4	7	,55	Less
R4/b	4	7	5,5	Less
R5/f	7	15	11	Enough
R6/e	7	14	10,5	Enough
R7/d	6	13	9,5	Enough
R8/a	4	7	5,5	Less
R9/c	5	7	6,0	Less
R10f	7	14	10,5	Enough
R11/a	4	7	5,5	Less
R12/f	7	15	11	Enough
R13f	7	15	11	Enough
R14e	7	14	10,5	Enough
R15f	7	15	11	Enough
R16e	7	14	10,5	Enough
R17c	5	7	6	Less
R18b	4	7	5,5	Less
R19c	5	5	5	Less
R20b	4	7	5,5	Less
R21f	7	15	11	Enough
R22f	7	15	11	Enough
R23e	7	13	10	Enough
R24b	4	7	5,5	Less
R25c	5	7	6	Less
R26a	4	6	5	Less
R27e	6	13	9,5	Cukup
R28f	7	15	11	Cukup
R29c	5	9	7,5	Less
R30a	4	7	5,5	Less
R31f	7	15	11	Enough
R32d	6	13	9,5	Enough
R33e	7	13	10	Enough
R34c	5	8	6,5	Less
R35e	6	13	6,5	Less
R36e	7	13	10	Enough
R37d	5	14	9,5	Less
R38e	7	15	11	Enough
R39f	7	15	11	Enough
R40e	7	15	7	Less
R41b	4	7	5,5	Less



<b>R42b</b>	4	7	5,5	Less
<b>R43c</b>	5	7	6,5	Less
<b>R44c</b>	4	7	5,5	Less
<b>R45d</b>	6	13	9,5	Enough
<b>R46e</b>	7	15	11	Enough
<b>R47f</b>	7	15	11	Enough
<b>R48f</b>	7	15	11	Enough
<b>R59f</b>	7	15	11	Enough
<b>R50f</b>	7	15	11	Enough
<b>Average</b>	5,76	11,22	8,28	Enough

**Table 4. Frequency Acquisition Speaking Tests and Observations Social Interaction retarded child on the Post Test (T<sub>2</sub>)**

Category	Interval	Frekuensi (F)		Persentase
		Speak s	Interak si	
<b>Very Good</b>	24 - 31			
<b>Good</b>	16 - 23			
<b>Enough</b>	15 - 8		29	58
<b>Less</b>	0 - 7	50		100
Sum		50	27	

Source: Preliminary Results of Analysis Test Scoresra

## Discussion

From Table 1 and Table 2 above, it can be seen that 50 students are 100% mentally disabled students in the City of Kendari, Southeast Sulawesi Province, Indonesia is in the category of lack of speaking ability and social interaction. The ability of speaking students who sit in grades one and two are in grade 4 and the ability to speak with the highest score is 7 those who sit in grade five and grade six.

The results of observations of social interaction of mentally disabled children who sit in classes one and two only get a value of 5, while those sitting in fifth and sixth grades get seven. However, all of the students' scores on the pretest were in the lacking category, which means that the initial test results showed the students' ability was at an average score of 5.56 speaking ability, the average value of social interaction was 5.80, while the combined average of the two values was 5.62 means that everything is in the interval 0-7 with less category.

The results showed less motivated students who are not characterized by lackluster expression and silence and many are

ignoring the material given by the teacher. Therefore, from these results that the application of learning technology-based roleplay method is needed by the student, the student application this method is expected to be fond of and motivated to learn in school. Learning the mentally disabled child a teacher is needed to build the trust of students, keep students motivated, happy in learning must not be separated from the efforts of teachers themselves Like [6] argues that teachers who build trust act in an intercultural context. They see the student as a whole with the size of the body, mind, and heart. Principles such as love, respect, honesty, courage, empathy, and kindness are important for teachers in peaceful schools. In these schools, students are the central focus of a peaceful school community.

Based on the results of data analysis after the application of the roleplay method based on table 3 and electronic learning from Table 3 and Table 4, it is known that 50 students or 100% students with mental disabilities in Kendari City, Southeast Sulawesi Province, Indonesia have low ability to speak. Their speaking ability did not increase significantly. The increase is only 0, 20%, from the average value of 5.56 to 5.76, in other words, it is still in the lacking category. While the social interaction has risen from an average of 5.80 to 11.22 category category less be enough. Speaking ability of students in grades one, two, three, and six did not have increased, the increase was a student sitting fourth and fifth grades. But the increase was still in less category. This is evidenced by the results of the significance test in Table 7 on the available ability to speak significance of 0.29 greater than 0.05 means that media role-play cannot improve the ability to speak of mentally retarded children.

However, this method is considered significant in increasing the social interaction of mentally retarded children, as seen from the results of the T-test in Table 10, the significance level is 0.00 which is smaller than 0.05.

This can be seen in Table 1 and Table 4 shows that the average value of students' speaking ability from 5.56 to 5.76 is still in the poor category. The average value of social interaction from 5.80 or less to 11.22 that is enough categories. The combined average value of the two values from the average value of 5.62 to 8.28 means that the combined value of speaking ability and social interaction has increased 2.66% from the category of insufficient to be in the interval of 8-15 with sufficient. The use of roleplay methods based on learning technology is an interesting learning media for students because they can see, hear so they can mimic conversations and behavior through

roleplay methods that exist on electronic media and in the real world. This helps the students to interact with peers, teachers, even with all those people who are in school and in society. This is in line with research [42] The results showed that the MUVE enabled the group members to exchange ideas in an authentic environment, and that the file-sharing platform used as a complement to the Multi-User Virtual Environments (MUVE) reinforced collaborative learning. As long as technical problems are prevented, effective collaborative learning can be achieved in these environments. [4] concluded Communication Technology with the Early Childhood Education curriculum is necessary to enhance an overall development of young children. Computers with relevant resources were thought to be the best Information and Communication Technology applications in Early Childhood Education for a developmentally appropriate programme that would provide educational concepts, problem solving skills and creativity.

ed on these results, it is recommended to teachers who teach in Special Schools or in inclusive schools should implement this method of learning. While the increase in the Traffic speaking skills of children did not show a significant improvement, but this method can create learning fun, innovative and make all students are active and zealous in their duties to take part in the learning process. This condition is expected to improve the social interaction between students, teachers to teachers, and students, which in turn can interact with students both within the family and in society.

## References

- [1] Amin, M. (1995). Ortopedagogik anak tunagrahita. *Jakarta: Depdikbud*.
- [2] Attas, S. G., Azmin, G. G., & Marwiah, M. (2019). REINTERPRETING THE GAMBANG RANCAG ORAL TRADITION. In *Proceeding of The International Conference on Literature* (Vol. 1, No. 1, pp. 277-286).
- [3] Aungwatanakun, S. (1994). English Teaching Methodology, (2nd),
- [4] Bose, K. (2017). Developmentally appropriate technology in early childhood (DATEC) in Botswana: In-service teachers' perspectives. *International Electronic Journal of Elementary Education*, 1(3), 218-231

- [5] Boonkit, K. (2010). Enhancing the development of speaking skills for non-native speakers of English. *Procedia-social and behavioral sciences*, 2(2), 1305-1309.
- [6] Calp, Ş. (2020). Peaceful and Happy Schools: How to Build Peaceful Learning Environments?. *International Electronic Journal of Elementary Education*, 12(4), 311-320.
- [7] Faisal, S. (1982). Metodologi penelitian pendidikan. *Surabaya: Usaha Nasional*.
- [8] Hallahan, D. P., Lloyd, J. W., Kneedler, R. D., & Marshall, K. J. (1982). A comparison of the effects of self-versus teacher-assessment of on-task behavior. *Behavior Therapy*, 13(5), 715-723.
- [9] Humaira, D., Fatmawati, F., & Zulmiyetri, Z. (2012). Pelaksanaan Pembelajaran Bahasa Indonesia Bagi Anak Tunagrahita Ringan Kelas III di SLB Sabiluna Pariaman. *Jurnal Penelitian Pendidikan Khusus*, 1(3).
- [10] Hummel, T. J., & Batty, C. M. (1989). A comparison of computer simulation and video-taped roleplays as instructional methods in the teaching of specific interviewing skills.
- [11] Hedge, T. (2001). *Teaching and learning in the language classroom* (Vol. 106). Oxford, England: Oxford university press.
- [12] Harmer, J. (1983). The practice of english language teaching, vol 11 (3).
- [13] Hanreddya, A., & Östlund, D. (2020). Alternate curricula as a barrier to inclusive education for students with intellectual disabilities. *International Electronic Journal of Elementary Education*, 12(3), 235-247.
- [14] Model, P. A. C. Development of Learning Poems Appreciation Character Model Based on STAD-Sugestopedia MARWIAH E-mail: marwiahawitompo@gmail.com.
- [15] Pinter, A., Kuchah, K., & Smith, R. (2013). Researching with children. *Elt Journal*, 67(4), 484-487.
- [16] Iskandar, W., & Sunendar, D. (2011). Language Learning Strategies.
- [17] Keith, H., & Keith, K. D. (2013). *Intellectual disability: Ethics, dehumanization, and a new moral community*. Chichester, England: Wiley-Blackwell.
- [18] Liu, G. Z., Wu, N. W., & Chen, Y. W. (2013). Identifying emerging trends for implementing learning technology in special education: A state-of-the-art review of selected articles

- published in 2008–2012. *Research in developmental disabilities*, 34(10), 3618–3628.
- [19] Laughlin, H. (2004). The eugenical sterilization of the feeble-minded. In S. Noll & J. W. Trent (Eds), *Mental retardation in America: A historical reader* (History of Disability Series, pp. 225–231). New York: New York University Press.
- [20] Oradee, T. (2012). Developing speaking skills using three communicative activities (discussion, problem-solving, and role-playing). *International Journal of Social Science and Humanity*, 2(6), 533.
- [21] Palmer, S. (2017). Examining the reliability and validity of the Supports Intensity Scale–Children’s Version in children with autism and intellectual disability.
- [22] *Focus on Autism and Other Developmental Disabilities*, 32, 293–304. doi:10.1177/1088357615625060.
- [23] Padu, K. (2007). Amin, M.(1995). Ortopedagogik Anak Tunagrahita. Bandung: Depdikbud
- [24] Arikunto, S.(2002). Prosedur Penelitian Suatu Pendekatan Praktek. Jakarta: PT Rineka Cipta. Arsyad, A.(2007). Media Pembelajaran. Jakarta: PT Raja Grafindo Persada. Bonneff, M.(2008). Komik Indonesia. Jakarta: Kepustakaan Populer Gramedia. Universitas.
- [25] Pivec, P., & Pivec, M. (2010). Collaborative Online Roleplay for Adult Learners. In *Design and Implementation of Educational Games: Theoretical and Practical Perspectives* (pp. 393–408). IGI Global.
- [26] Roestiyah N.K. (2008). Strategi Belajar Mengajar. Jakarta: Penerbit Rineka Cipta
- [27] Rochyadi, E., & Alimin, Z. (2005). Pengembangan program pembelajaran individual bagi anak tunagrahita. *Jakarta: Depdiknas Dirjen Dikti Direktorat pembinaan Pembinaan Pendidikan Tenaga Kependidikan dan Ketenagaan Perguruan Tinggi*.
- [28] Rochyadi, E. (2012). Karakteristik dan Pendidikan Anak Tunagrahita. *Modul pada Universitas Pendidikan Indonesia: tidak diterbitkan*.
- [29] Sudirman, M., & Nessa, M. N. (1992). *Light Fishing in Wallacea Area, Sustainable or Destructive* (pp. 1–10). Working paper.
- [30] Somantri, H. T. Sutjihati. 1995. *Psikologi ALB. Jakarta: Dirjen Dikti Proyek Pendidikan Tenaga Guru*.

- [31] Sudirman N. (1992). Ilmu Pendidikan. Jakarta: Penerbit Rosda Karya
- [32] Swedish Government Official Reports. (1948:27). *1946 – års skolkommissions betänkande med förslag till riktlinjer för det svenska skolväsendets utveckling* [Guidelines for development of the Swedish school system. Report from the 1946 School Commission]. Stockholm, Sweden: Fritze.
- [33] Shumin, K. (2002). Factors to consider: Developing adult EFL students' speaking abilities. *Methodology in language teaching: An anthology of current practice*, 12, 204-211.
- [34] Shogren, K., Wehmeyer, M. L., Seo, H., Thompson, J., Schalock, R., Hughes, C., &
- [35] Somantri, W. A. (1996). *Penerapan model problem based learning berbasis literasi informasi untuk meningkatkan kemampuan menulis laporan deskriptif: Penelitian tindakan kelas di Kelas IV MI Al-Muttaqin Kab. Bandung* (Doctoral dissertation, UIN Sunan Gunung Djati Bandung).
- [36] Shogren, K., Luckasson, R., & Schalock, R. (2014). The definition of “context” and its application in the field of intellectual disability. *Journal of Policy and Practice in Intellectual Disabilities*, 11, 109-116. doi:10.1111/jppi.12077.
- [37] Santoso, S. (2014). Statistik Parametrik: Konsep dan Aplikasi SPSS. *Edisi Revisi*, 2.
- [38] Sudirman N. (1992). Ilmu Pendidikan. Jakarta: Penerbit Rosda Kar
- [39] Shumin, K. (2002). Factors to consider: Developing adult EFL students' speaking abilities. *Methodology in language teaching: An anthology of current practice*, 12, 204-211.
- [40] Shogren, K., Luckasson, R., & Schalock, R. (2014). The definition of “context” and its application in the field of intellectual disability. *Journal of Policy and Practice in Intellectual Disabilities*, 11, 109-116. doi:10.1111/jppi.12077.
- [41] Shogren, K., Wehmeyer, M. L., Seo, H., Thompson, J., Schalock, R., Hughes, C., & Palmer, S. (2017). Examining the reliability and validity of the Supports Intensity Scale–Children’s Version in children with autism and intellectual disability. *Focus on Autism and Other Developmental Disabilities*, 32, 293-304. doi:10.1177/1088357615625060
- [42] Talaee, E. (2019). Longitudinal Impacts of Home Computer Use in Early Years on Children’s Social and Behavioral

- Development. *International Electronic Journal of Elementary Education*, 11(3), 233-245.
- [43] Taub, D., & Foster, M. (2020). Inclusion and Intellectual Disabilities: A Cross Cultural Review of Descriptions. *International Electronic Journal of Elementary Education*, 12(3), 275-281.
- [44] Tolla, A., & Setiawan, M. I. (2018, November). The Development of the Tedars Hypnosis-Based Poetry Appreciation Learning Model. In *Journal of Physics: Conference Series* (Vol. 1114, No. 1, p. 012037). IOP Publishing.
- [45] Ur, P. (1996). *A Course in Language Teaching* Cambridge
- [46] Vlachou, A. (2004). Education and inclusive policy-making: Implications for research and practice. *International Journal of Inclusive Education*, 8(1), 3-21.
- [47] Watson, L. (2017). Workshop exploring children's understandings of online safety: Storytelling and roleplay as research methods.
- [48] World Health Organization (WHO). (2011). *World report on disability*. Retrieved from [https://www.who.int/disabilities/world\\_report/2011/report.pdf](https://www.who.int/disabilities/world_report/2011/report.pdf)
- [49] Warland, J., & Smith, M. (2012). Using online roleplay in undergraduate midwifery education: A case-study. *Nurse education in practice*, 12(5), 279-283.
- [50] Haerunisa, I., Anwar, C., Masykur, R., Hadiati, E., Patimah, S., & Wahid, K. (2021). Management Of Character Education Through Online Learning During The Covid-19 Pandemic At State Madrasah Tsanawiyahin Way Kanan. *NVEO-NATURAL VOLATILES & ESSENTIAL OILS Journal| NVEO*, 5989-6002.
- [51] Putra, P., Liriwati, F. Y., Tahrim, T., Syafrudin, S., & Aslan, A. (2020). The Students Learning from Home Experience during Covid-19 School Closures Policy in Indonesia. *Jurnal Iqra*, 5(2).
- [52] Maliki, B. I., Kusuma, J. W., Mulyadi, M., Meilisa, R., & Hamidah, H. (2021). Distance Learning In An Educational Perspective In Indonesia During The Covid-19 Pandemic. *Jurnal Educatio FKIP UNMA*, 7(3), 606-614.
- [53] Bahadorfar, M., & Omidvar, R. (2014). Technology in teaching speaking skill. *Acme International Journal of Multidisciplinary Research*, 2(4), 9-13.
- [54] Bahrani, T., & Soltani, R. (2012). How to teach speaking skill. *Journal of education and Practice*, 3(2),

- [55] Amrullah, A. Z. (2015). Developing language games to teach speaking skill for Indonesian senior high school learners. *JEELS (Journal of English Education and Linguistics Studies)*, 2(2).25-29.
- [56] Nisaiyah, K. (2021). THE STRATEGIES TO TEACH SPEAKING SKILL AT MTS TARBIYATUL ISLAM SOKO TUBAN DURING THE PANDEMIC OF COVID-19. *EDUTAMA*.
- [57] Hunt, P. (Ed.). (2006). *Understanding children's literature*. Routledge.
- [58] Young, A., Carr, G., Hunt, R., McCracken, W., Skipp, A., & Tattersall, H. (2006). Informed choice and deaf children: Underpinning concepts and enduring challenges. *Journal of Deaf Studies and Deaf Education*, 11(3), 322-336.
- [59] Morrow, V., & Richards, M. (1996). The ethics of social research with children: An overview 1. *Children & society*, 10(2), 90-105.



# Antibiofilm Activity of Honey in Multispecies Pathogen

Masfufatun, Lusiani Tjandra, Budhi Setiawan

## Introduction

The invention of antimicrobial agents is an important contribution to the improvement of life-threatening communicable disease therapy. However, as a result of the widespread use of these useful drugs, a slew of new resistance mechanisms has developed and spread rapidly among bacteria that cause disease. Antibiotics resistance becomes more commonly found than before for instance bacteria strains that cannot be killed by Methicillin, Vancomycin, and Carbapenem [1], [2]. Besides mutations or gene resistance acquisition, this resistance could be caused by the ability of the microorganisms to form biofilms on the tissues or medical devices [2].

Microorganisms' biofilm is a complex protective mechanism structure in which microbes stick one to another to a surface. These aggregate cells are embedded within a slimy substance called extracellular polymeric substances (EPS) result in an increment of surface attachment ability, a higher population density, as well as pathogenicity improvement [3]. The protective effects of biofilm formation from antimicrobial agents include decreased penetration, drug molecules trap in the extracellular matrix and higher concentration microbial inactivation enzymes [4]. The Biofilm formation may cause microorganisms become more difficult to eradicate from the host due to higher tolerance to standard antimicrobial drugs and also resistance to phagocytosis [5]. Moreover, in the form of biofilms, particular fungi such as *Candida albicans* is able to produce 2.3 times higher concentration of carcinogenic compounds such as acetaldehyde [6]. To overcome this problem, it is necessary to find better alternative treatment strategies to prevent, mitigate and destroy biofilms.

In the midst of various approaches that have been studied to control biofilm formation, the use of natural products has shown a promise. Honey has been known for its potential health benefits such as anti-inflammatory, anti-cancerous, antiviral, and anti-oxidant activities since 19<sup>th</sup> century [7]. In vitro and in vivo studies have shown honey exhibited a potential as a broad-spectrum antibiotic, antiviral and antifungal activities. [8]. Honey is a complex blend of many organic and inorganic compounds such as sugars, proteins,

minerals, vitamin, enzymes, phenolic acid, organic acids, pigments, minerals, phenolic acids, flavonoids and many other elements [9]. Honey's antimicrobial activity is determined by a number of bioactive substances, and one of them commonly studied such as hydrogen peroxide (H<sub>2</sub>O<sub>2</sub>). This substance is produced from the reaction between glucose and glucose oxidase activated when the honey is diluted. Hydrogen peroxide has been frequently suggested a major contributor for honey antimicrobial activities [10], [11].

A part from inhibition the growth of planktonic microorganism cells, honey also has demonstrated antibiofilm activity during in vitro studies. The antibacterial activities of honey on *Staphylococcus aureus*, *Pseudomonas aeruginosa* and other bacterial biofilms have been examined [12]–[15]. Honey also reduces the extracellular polysaccharide matrix production of microorganism thus results in mature biofilm integrity disturbance [16]. However, honey antibiofilm activity against fungi such as *Candida sp.* has not been widely explored. Therefore, this narrative review will discuss about phytochemicals, antimicrobial and antifungal properties as well as honey antibiofilm effect against bacteria and fungi.

### **Composition of honey**

The composition of honey is very complex containing at least 181-200 different substances. In general, 100g of honey contains 82.4 g of total carbohydrates, consisting of Fructose 38.5 g, Glucose 31.28 g, Sucrose 1.31 g, Maltose 7.31. Total gluconic acid 0.57 g, Moisture content 17.1 g, Ash 0.169 g, Fiber 0.2 g, Amino acids / proteins 0.3 g, N 0.041 g, Iron 0.42 mg, Potassium 52 mg, Calcium 6.00 mg, Phosphorus 4.00 mg, Magnesium 2.00 mg, Copper 1–100 µg / g, Zinc 0.22 mg, Riboflavin 0.038 mg, Niacin 0.21 mg, Pantothenic acid 0.068 mg, Pyridoxine 0.024 mg, Folic acid 2 µg, Vitamin C 0.5 mg. Honey also contains enzymes namely invertase, diastase, catalase, glucose oxidase, phosphatase, and protease [17], [18], [19], [20].

### **Bioactive components and anti-microbial mechanism of honey**

Hydrogen Peroxide is produced from the results of the glucose oxidase reaction where the enzymes in honey convert glucose into gluconolactone. Hydrogen Peroxide causes the death of microorganisms [21]. The antimicrobial activities in several types of honeys depend on the endogenous concentration hydrogen peroxide known as a disinfectant and a strong oxidizing agent. Honey also contains polyphenols, including Gallic acid, Ferulic acid, Chlorogenic

acid, Ellagic acid, Syringic acid and Caffeic acid and these bioactive compounds are also considered as antibacterial effect sources in honey [22]. There are more than 150 polyphenol compounds in honey. These polyphenolic compounds have function as antioxidants [23]. Honey antioxidant activity is mainly due to phenolic and flavonoid compounds. The level of honey antioxidant activity is proportional to the value of phenolic and flavonoid concentration [24].

Methylglyoxal (MGO) is a highly reactive dicarbonyl compound (1,2-dicarbonyl methylglyoxal) and it induces rapid and non-enzymatic modification of lysine and arginine residues of protein resulting generation of advanced glycation end products or AGEs [25]. Non-enzymatic conversion of dihydroxyacetone in Manuka honey is the source of MGO production. In Manuka honey stored for less than 1 year, the MGO level was from 0.102 to 0.793 mg / g, the level would increase to 1.541 mg / g when long-term storage or heat treatment [26]. At MGO levels above 0.15 mg / g, this is what causes the antibacterial properties of Manuka honey. Other types of honey have low MGO levels, ranging from 0.0004 to 0.0054 mg / g [27], [28].

Water is the main constituent of living things and honey only contains approximately 15% - 21% water. The water concentration in honey is low enough to allow bacteria or other microorganism growth and the activity of unbound water molecules ranges from 0.562 to 0.62 [29]. The high osmosis power of honey is because 84% of the components contained in honey consist of glucose and fructose). Osmolarity results in strong interactions between sugar molecules and water molecules and leaves very few water molecules. This osmotic pressure will cause the microorganisms to become dehydrated so that they cannot grow. Also, the high osmosis effect of honey inhibits bacterial growth [29], [30], [31]. The acidity level of honey has a pH of 3.2 - 4.5 and this characteristic will inhibit bacterial metabolism and cause bacteria to easily undergo lysis and bacteria to die [32]. The optimum pH for bacterial growth ranges from pH 7.2 to 7.4 [33].

Honey has the potential to inhibit the activity of many pathogenic bacteria including gram-negative and gram-positive bacteria [34], [35]. Manuka honey has activity bactericidal against planktonic cells and biofilms of *Pseudomonas aeruginosa* and *Staphylococcus aureus* honey and their antibiotic activity against *Pseudomonas aeruginosa* was higher than that of *Staphylococcus aureus* [36]. In addition, it was also reported that planktonic *S. aureus*

cells exposed to Manuka honey enlarged and had more septa [37]. Manuka honey interacts synergistically with vancomycin antibiotics in the formation of *S. aureus* biofilms and interacts additively with gentamicin antibiotics in the formation of *P. aeruginosa* biofilms [38]. Manuka and clover honey showed good activity against planktonic cells and biofilms from *Staphylococcus aureus*, *Pseudomonas aeruginosa*, *Klebsiella spp.*, and *Proteus mirabilis* [39].

The mechanism of honey as an anti-fungal is still being debated, but several studies say that the mechanism is almost the same as honey as an antibacterial with active substances H<sub>2</sub>O<sub>2</sub>, flavonoids, methylglyoxal, as well as high sugar content that can affect fungal growth [40], [41], [42], [43].

### **Different types of honey anti-biofilm activity**

Biofilms are a major mode of microbial growth and are essential to development of infection. Cell adhesion, microcolonies formation and biofilm maturation are important stages of biofilm growth. From these structures, bacteria can spread and develop colonies in new environments [44]. Biofilm can be identified using biopsy as a standard procedure of diagnosis in wounds. Often, staining of the biopsy samples is able to identify microcolonies, extracellular polysaccharide matrix, and inflammatory cells [45].

Not only bacteria, various clinically significant fungi also form biofilms such as *Candida*, *Aspergillus*, *Cryptococcus*, *Trichosporon*, *Coccidioides*, and *Pneumocystis* [46]. Even though *Candida albicans* is one of commonly studied fungi as biofilm producers but *Cryptococcus neoformans* and *Aspergillus fumigatus*, have been known also play significant role in biofilm-related infections. Adhesion, colonization, maturation and dispersal are the developmental stages of fungal biofilm formation which are controlled by complex molecular events [47].

A biofilm is a complex structure made of aggregate of microbial cells and extracellular polymeric substances (EPS) on any surface [48], which can prevent the healing process [49]. A biofilm formation may create a physical barrier that can inhibit infiltration of antibiotics and decrease the chance of wound disinfection [50]. Antibiotic resistance of bacteria in the existence of biofilm has significant contribution to the chronicity of infections. While the exact cause the resistance remains uncertain, several studies have shown that it might be multimodal strategies [51], [52]. Bacterial biofilms may lead to chronic infections due to the increment of tolerance to

antibacterial agents and chemical disinfectant, and phagocytosis prevention. It might be associated also with an increased level of mutations as well as with quorum-sensing pathways. Other factors such as common mechanisms of resistance, efflux pumps upregulation and antibiotic target molecules mutations in bacteria may also promote to the formation of biofilms [53]. It has been suggested that over 75% of microbial infections in the human body is characterized by biofilm-related infections [54].

It has been shown by studies that systemic infection is initiated by biofilm dispersal since start from this point, the bacteria exit from biofilm structure and disseminates inside of the host [55], [56]. The release of singular cells and/or multicellular aggregates of bacteria controlled by an active phenotype change involving the sensing of environmental signals and their transduction via complex regulatory networks to final effectors [57]. Similar to the ability to form biofilms, the dispersion of microorganism seems to be a common property shared by most bacteria that cause them suitable for colonization of new niches [58].

It is well established that chronic wounds such as diabetic foot ulcers, pressure ulcers, and venous leg ulcers are difficult to treat and the evidence of bacterial biofilm was abundantly found in specimens from chronic wounds [59]. Evidence from studies suggests that the formation of polymicrobial biofilm in skin and wound infections could be a risk factor for relapse and the treatment become more challenging because of antibiotic resistance [60]. Risk of infection and chronic inflammation increase since biofilm may prolong and prevent healing in both acute and chronic wounds [45]. Mechanical debridement followed by topical antimicrobial agents are crucial to mitigate biofilm reformation because of commercially available antimicrobials and wound dressings are often ineffective in managing biofilm [61]. Efficacious novel antibiofilm agents' development become an area of interest in wound care. The multimodal anti-biofilm mechanism of different types honey and their efficacy against multidrug-resistant bacteria would make it an exciting prospect for forthcoming study [62].

Antibacterial properties of honey have been associated to various bioactive ingredients and mechanisms. These properties include methylglyoxal (MGO), hydrogen peroxide, defensin-1, flavonoids, bee peptides, dehydration of the wound and a low pH and high osmotic pressure [63]–[66]. Specific mechanism might be predominantly involved for particular microorganism for instance the

osmotic effect of honey demonstrates significant antibacterial effect for *Helicobacter pylori*, while hydrogen peroxide only exhibits a minor contribution [63]. On the other hand, Egyptian honeys have mostly show antimicrobial activity against *Escherichia coli* mainly by hydrogen peroxide production [67]. Furthermore, the antibacterial efficacy of Manuka honey towards *Escherichia coli* and *Staphylococcus aureus* was found directly to the presence of methylglyoxal [68]. However, the bactericidal activity of Manuka honey is still effective on *Escherichia coli* even after neutralization of its methylglyoxal component due to several unknown factors [69]. Methylglyoxal has demonstrated the antibacterial activity of manuka honey against *Bacillus subtilis* and *Staphylococcus aureus* and but not against *Pseudomonas aeruginosa* and *Escherichia coli* [69]. Among the aforementioned antibacterial mechanism of actions, Methylglyoxal (MGO) appeared to be associated to Manuka honey's efficacy to prevent biofilm formation. Moreover, Manuka honey has shown "significant partial detachment" at 50% concentration of *Proteus mirabilis* biofilms after 24 hours [70]. However, though Manuka honey can infiltrate the biofilm and kills bacterial cells but MGO administration alone is not responsible for this effect, highlighting the importance of other bioactive substances in honey's antibacterial activity, especially on *Staphylococcus aureus* and *Pseudomonas aeruginosa* strains [71], [72].

Even though in vitro studies have demonstrated prospective anti-biofilm efficacy of different types of honey [14] but current randomized controlled trial (RCT) has found no superiority of honey in preventing biofilm on infections when compared with standard care in some settings [73]. Perhaps, antibiofilm activity reported by in vitro assay studies might have inadequate clinical relevance [71], [72]. A recent review study found that there is evidence with limited quality of honey's beneficial effect for partial thickness burns healing. However, inconclusive evidence regarding the use of honey for other wound-related indications. For partial thickness burns, treatment with honey may heal faster compared to conventional dressing [74].

## **Conclusion**

Honey exhibits antibacterial activity against a wide variety of gram-positive and gram-negative bacteria, antibiotic-resistant as well as antibiotic-sensitive bacteria. Several honey bioactive components may contribute not only to the antibacterial efficacy but also antifungal effect. These bioactive substances provide a synergy that

result in modulation of the resistance to antimicrobial drugs. Honey demonstrates activities against both planktonic and biofilm phenotype states of microorganisms. Microorganism's planktonic and biofilm states play important role in delaying healing of wounds. There is a very large variation in terms of the anti-microorganism's potency of different types of honey. Manuka is one of the most studied honey which has in vitro activity against both planktonic and biofilm microorganisms. It is clinically important, particularly since most traditional antibiotics or antifungal lack activity against biofilms. However, further clinical studies are required to test the efficacy of the prospective anti-biofilm efficacy of honey as a treatment for wounds and other health conditions.

## References

- [1] World Health Organization, *Antimicrobial resistance: global report on surveillance*, World Health Organization, 2014.
- [2] G. M. Rossolini, F. Arena, P. Pecile, and S. Pollini, "Update on the antibiotic resistance crisis," *Current Opinion in Pharmacology*, vol. 18, pp. 56–60, 2014, doi: 10.1016/J.COPH.2014.09.006.
- [3] F. Nazzaro *et al.*, "Anti-Biofilm Properties Exhibited by Different Types of Monofloral Honey," *Proceedings 2020, Vol. 66, Page 16*, vol. 66, no. 1, p. 16, Jan. 2021, doi: 10.3390/PROCEEDINGS2020066016.
- [4] N. Høiby, T. Bjarnsholt, M. Givskov, S. Molin, and O. Ciofu, "Antibiotic resistance of bacterial biofilms," *International Journal of Antimicrobial Agents*, vol. 35, no. 4, pp. 322–332, 2010, doi: 10.1016/j.ijantimicag.2009.12.011.
- [5] K. Lewis, "Riddle of biofilm resistance," *Antimicrobial Agents and Chemotherapy*, vol. 45, no. 4, pp. 999–1007, 2001, doi: 10.1128/AAC.45.4.999-1007.2001.
- [6] Masfufatun *et al.*, "serum acetaldehyde as a potential biomarker for the detection of pathogenic biofilm formation by *Candida albicans*," *Journal of Chemical Technology and Metallurgy*, vol. 52, no. 6, pp. 1032–1038, 2017.
- [7] M. Küçük, S. Kolayli, Ş. Karaoğlu, E. Ulusoy, C. Baltacı, and F. Candan, "Biological activities and chemical composition of three honeys of different types from Anatolia," *Food Chemistry*, vol. 100, no. 2, pp. 526–534, 2007, doi: 10.1016/j.foodchem.2005.10.010.
- [8] N. S. Al-Waili, F. S. Al-Waili, M. Akmal, A. Ali, K. Y. Salom, and A. A. Al Ghamdi, "Effects of natural honey on polymicrobial culture of

- various human pathogens," *Archives of Medical Science*, vol. 10, no. 2, pp. 246–250, 2014, doi: 10.5114/aoms.2012.28603.
- [9] S. Wyndham Lewis, "Eva Crane: Honey, 'A Comprehensive Survey,'" *Bee World*, vol. 98, no. 3, pp. 105–105, Jul. 2021, doi: 10.1080/0005772X.2020.1865626.
- [10] J. W. White, M. H. Subers, and A. I. Schepartz, "The identification of inihibine, the antibacterial factor in honey, as hydrogen peroxide and its origin in a honey glucose-oxidase system," *BBA - Biochimica et Biophysica Acta*, vol. 73, no. 1, pp. 57–70, 1963, doi: 10.1016/0006-3002(63)90359-7.
- [11] L. M. Bang, C. Bunting, and P. Molan, "Peroxide production in honey & its implications," *Journal of Alternative & Complementary Medicine*, vol. 9, no. 2, pp. 267–273, 2003.
- [12] T. Alandejani *et al.*, "Effectiveness of honey on Staphylococcus aureus and Pseudomonas aeruginosa biofilms," *Otolaryngology - Head and Neck Surgery*, vol. 141, no. 1, pp. 114–118, 2009, doi: 10.1016/j.otohns.2009.01.005.
- [13] P. Merckoll *et al.*, "Bacteria, biofilm and honey: A study of the effects of honey on 'planktonic' and biofilm-embedded chronic wound bacteria," *Scandinavian Journal of Infectious Diseases*, vol. 41, no. 5, pp. 341–347, 2009, doi: 10.1080/00365540902849383.
- [14] R. Cooper, L. Jenkins, and S. Hooper, "Inhibition of biofilms of Pseudomonas aeruginosa by Medihoney in vitro," *Journal of Wound Care*, vol. 23, no. 3, pp. 93–104, 2014, doi: 10.12968/JOWC.2014.23.3.93.
- [15] N. HM, L. M, G. RL, H. M. Nassar, M. Li, and R. L. Gregory, "Effect of honey on Streptococcus mutans growth and biofilm formation," *Applied and Environmental Microbiology*, vol. 78, no. 2, pp. 536–540, 2012, doi: 10.1128/AEM.05538-11.
- [16] O. A. Okhiria, "The role of biofilm in wounds," no. May, 2010.
- [17] L. Vorlová and A. Pridal, "Invertase and diastase activity in honeys of Czech provenience," vol. 5, no. 2002, pp. 57–66, 2010.
- [18] I. C. F. R. Ferreira, E. Aires, J. C. M. Barreira, and L. M. Estevinho, "Antioxidant activity of Portuguese honey samples: Different contributions of the entire honey and phenolic extract," *Food Chemistry*, vol. 114, no. 4, pp. 1438–1443, 2009, doi: 10.1016/j.foodchem.2008.11.028.
- [19] I. I. Fatma, S. Haryanti, and S. W. A. Suedy, "Uji kualitas madu pada beberapa wilayah budidaya lebah madu di Kabupaten Pati," *Jurnal Akademika Biologi*, vol. 6, no. 2, pp. 58–65, 2017.



- [20] S. Ahmed *et al.*, "Honey as a Potential Natural Antioxidant Medicine: An Insight into Its Molecular Mechanisms of Action," *Oxidative Medicine and Cellular Longevity*, vol. 2018, 2018, doi: 10.1155/2018/8367846.
- [21] P. B. Olaitan, O. E. Adeleke, and I. O. Ola, "Honey: A reservoir for microorganisms and an inhibitory agent for microbes," *African Health Sciences*, vol. 7, no. 3, pp. 159–165, 2007, doi: 10.5555/afhs.2007.7.3.159.
- [22] S. Almasaudi and A. Saad, "The Antibacterial Activities of Honey," *Saudi Journal of Biological Sciences*, 2020, doi: 10.1016/j.sjbs.2020.10.017.
- [23] I. C. F. R. Ferreira, E. Aires, J. C. M. Barreira, and L. M. Estevinho, "Antioxidant activity of Portuguese honey samples: Different contributions of the entire honey and phenolic extract," *Food Chemistry*, vol. 114, no. 4, pp. 1438–1443, 2009, doi: 10.1016/j.foodchem.2008.11.028.
- [24] Ustadi, L. E. Radiati, and I. Thohari, "Komponen Bioaktif pada Madu Karet (*Hevea brasiliensis*) Madu Kaliandra (*Calliandra calothyrsus*) dan Madu Randu (*Ceiba pentandra*)," *Jurnal Ilmu dan Teknologi Hasil Ternak*, vol. 12, no. 2, pp. 97–102, 2017.
- [25] J. Majtan *et al.*, "Methylglyoxal-induced modifications of significant honeybee proteinous components in manuka honey: Possible therapeutic implications," *Fitoterapia*, vol. 83, no. 4, pp. 671–677, 2012, doi: 10.1016/j.fitote.2012.02.002.
- [26] J. M. Stephens *et al.*, "Phenolic compounds and methylglyoxal in some New Zealand manuka and kanuka honeys," *Food Chemistry*, vol. 120, no. 1, pp. 78–86, 2010, doi: 10.1016/j.foodchem.2009.09.074.
- [27] J. Atrott and T. Henle, "Methylglyoxal in manuka honey - correlation with antibacterial properties," *Czech Journal of Food Sciences*, vol. 27, no. SPEC. ISS., pp. 2008–2010, 2009, doi: 10.17221/911-cjfs.
- [28] K. U. Weigel, T. Opitz, and T. Henle, "Studies on the occurrence and formation of 1,2-dicarbonyls in honey," *European Food Research and Technology*, vol. 218, no. 2, pp. 147–151, 2004, doi: 10.1007/s00217-003-0814-0.
- [29] P. C. Molan, "The role of honey in the management of wounds," *Journal of wound care*, vol. 8, no. 8, pp. 415–418, 1999, doi: 10.12968/jowc.1999.8.8.25904.
- [30] N. F. Nadhilla, "the activity of antibacterial agent of honey against *Staphylococcus aureus*," *J Majority*, vol. 3, no. 7, pp. 94–101, 2014.

- [31] S. P. Fitriyaningsih, A. Khairat, and R. Choestrina, "Aktivitas antibakteri madu Pahit dan Madu Hitam manis terhadap *Escherichia coli* dan *Staphylococcus aureus*," *Jurnal farmasi Galenika*, vol. 1, no. 2, pp. 32–37, 2014.
- [32] B. Pieper, "Honey-based dressings and wound care: An option for care in the United States," *Journal of Wound, Ostomy and Continence Nursing*, vol. 36, no. 1, pp. 60–66, Jan. 2009, doi: 10.1097/01.WON.0000345177.58740.7D.
- [33] G. D. Aggad H, "Honey Antibacterial Activity," *Medicinal & Aromatic Plants*, vol. 03, no. 02, pp. 3–4, 2014, doi: 10.4172/2167-0412.1000152.
- [34] J. Lu *et al.*, "Manuka-type honeys can eradicate biofilms produced by *Staphylococcus aureus* strains with different biofilm-forming abilities," *PeerJ*, vol. 2014, no. 1, pp. 1–25, 2014, doi: 10.7717/peerj.326.
- [35] J. J. Veloz, N. Saavedra, A. Lillo, M. Alvear, L. Barrientos, and L. A. Salazar, "Antibiofilm Activity of Chilean Propolis on *Streptococcus mutans* Is Influenced by the Year of Collection," *BioMed Research International*, vol. 2015, 2015, doi: 10.1155/2015/291351.
- [36] I. D. Iliev *et al.*, "Interactions between commensal fungi and the C-type lectin receptor Dectin-1 influence colitis," *Science (New York, N.Y.)*, vol. 336, no. 6086, pp. 1314–1317, Jun. 2012, doi: 10.1126/SCIENCE.1221789.
- [37] R. Jenkins, A. Roberts, and H. L. Brown, "On the antibacterial effects of manuka honey: mechanistic insights," *Research and Reports in Biology*, p. 215, 2015, doi: 10.2147/rrb.s75754.
- [38] M. E. M. Campeau and R. Patel, "Antibiofilm Activity of Manuka Honey in Combination with Antibiotics," *International Journal of Bacteriology*, vol. 2014, pp. 1–7, 2014, doi: 10.1155/2014/795281.
- [39] Abbas, Hisham A. "Comparative antibacterial and antibiofilm activities of manuka honey and Egyptian clover honey." *Asian Journal of Applied Sciences*, vol. 2, no. 2, 2014.
- [40] S. Anand, M. Deighton, G. Livanos, E. C. K. Pang, and N. Mantri, "Agastache honey has superior antifungal activity in comparison with important commercial honeys," *Scientific Reports*, vol. 9, no. 1, pp. 1–14, 2019, doi: 10.1038/s41598-019-54679-w.
- [41] M. Candiracci, B. Citterio, G. Diamantini, M. Blasa, A. Accorsi, and E. Piatti, "Honey flavonoids, natural antifungal agents against *Candida albicans*," *International Journal of Food Properties*, vol.

- 14, no. 4, pp. 799–808, 2011, doi: 10.1080/10942910903453355.
- [42] L. Fernandes *et al.*, “Portuguese honeys as antimicrobial agents against *Candida* species,” *Journal of Traditional and Complementary Medicine*, vol. 11, no. xxxx, pp. 130–136, Mar. 2020, doi: 10.1016/j.jtcme.2020.02.007.
- [43] P. H. S. Kwakman *et al.*, “Medical-grade honey kills antibiotic-resistant bacteria in vitro and eradicates skin colonization,” *Clinical Infectious Diseases*, vol. 46, no. 11, pp. 1677–1682, 2008, doi: 10.1086/587892.
- [44] C. Guilhen *et al.*, “Transcriptional profiling of *Klebsiella pneumoniae* defines signatures for planktonic, sessile and biofilm-dispersed cells,” *BMC genomics*, vol. 17, no. 1, 2016, doi: 10.1186/S12864-016-2557-X.
- [45] S. L. Percival, “Importance of biofilm formation in surgical infection,” *The British journal of surgery*, vol. 104, no. 2, pp. e85–e94, Jan. 2017, doi: 10.1002/BJS.10433.
- [46] S. Fanning and A. P. Mitchell, “Fungal Biofilms,” *PLOS Pathogens*, vol. 8, no. 4, p. e1002585, 2012, doi: 10.1371/JOURNAL.PPAT.1002585.
- [47] G. Ramage, E. Mowat, B. Jones, C. Williams, and J. Lopez-Ribot, “Our Current Understanding of Fungal Biofilms,” <https://doi.org/10.3109/10408410903241436>, vol. 35, no. 4, pp. 340–355, Nov. 2009, doi: 10.3109/10408410903241436.
- [48] M. A. Jabra-Rizk, W. A. Falkler, and T. F. Meiller, “Fungal Biofilms and Drug Resistance,” *Emerging Infectious Diseases*, vol. 10, no. 1, p. 14, 2004, doi: 10.3201/EID1001.030119.
- [49] R. Edwards and K. G. Harding, “Bacteria and wound healing,” *Current opinion in infectious diseases*, vol. 17, no. 2, pp. 91–96, Apr. 2004, doi: 10.1097/00001432-200404000-00004.
- [50] M. v. Ranall, M. S. Butler, M. A. Blaskovich, and M. A. Cooper, “Resolving Biofilm Infections: Current Therapy and Drug Discovery Strategies,” *Current Drug Targets*, vol. 13, no. 11, pp. 1375–1385, Oct. 2012, doi: 10.2174/138945012803530251.
- [51] P. S. Stewart and J. W. Costerton, “Antibiotic resistance of bacteria in biofilms,” *The Lancet*, vol. 358, no. 9276, pp. 135–138, Jul. 2001, doi: 10.1016/S0140-6736(01)05321-1.
- [52] A. Bridier, R. Briandet, V. Thomas, and F. Dubois-Brissonnet, “Resistance of bacterial biofilms to disinfectants: a review,” <http://dx.doi.org/10.1080/08927014.2011.626899>, vol. 27, no. 9,

- pp. 1017–1032, Oct. 2011, doi: 10.1080/08927014.2011.626899.
- [53] N. Høiby, T. Bjarnsholt, M. Givskov, S. Molin, and O. Ciofu, “Antibiotic resistance of bacterial biofilms,” *International Journal of Antimicrobial Agents*, vol. 35, no. 4, pp. 322–332, 2010, doi: 10.1016/j.ijantimicag.2009.12.011.
- [54] D. Davies, “Understanding biofilm resistance to antibacterial agents,” *Nature reviews. Drug discovery*, vol. 2, no. 2, pp. 114–122, Feb. 2003, doi: 10.1038/NRD1008.
- [55] R. Wang *et al.*, “Staphylococcus epidermidis surfactant peptides promote biofilm maturation and dissemination of biofilm-associated infection in mice,” *The Journal of Clinical Investigation*, vol. 121, no. 1, pp. 238–248, Jan. 2011, doi: 10.1172/JCI42520.
- [56] L. R. Marks, B. A. Davidson, P. R. Knight, and A. P. Hakansson, “Interkingdom signaling induces *Streptococcus pneumoniae* biofilm dispersion and transition from asymptomatic colonization to disease,” *mBio*, vol. 4, no. 4, Jul. 2013, doi: 10.1128/MBIO.00438-13.
- [57] O. E. Petrova and K. Sauer, “Escaping the biofilm in more than one way: desorption, detachment or dispersion,” *Current Opinion in Microbiology*, vol. 30, pp. 67–78, Apr. 2016, doi: 10.1016/J.MIB.2016.01.004.
- [58] C. Guilhen, C. Forestier, and D. Balestrino, “Biofilm dispersal: multiple elaborate strategies for dissemination of bacteria with unique properties,” *Molecular Microbiology*, vol. 105, no. 2, pp. 188–210, Jul. 2017, doi: 10.1111/MMI.13698.
- [59] G. A. James *et al.*, “Biofilms in chronic wounds,” *Wound Repair and Regeneration*, vol. 16, no. 1, pp. 37–44, Jan. 2008, doi: 10.1111/J.1524-475X.2007.00321.X.
- [60] K. S. Akers *et al.*, “Biofilms and persistent wound infections in United States military trauma patients: a case-control analysis,” *BMC infectious diseases*, vol. 14, no. 1, Apr. 2014, doi: 10.1186/1471-2334-14-190.
- [61] C. E. Black and J. W. Costerton, “Current concepts regarding the effect of wound microbial ecology and biofilms on wound healing,” *The Surgical clinics of North America*, vol. 90, no. 6, pp. 1147–1160, Dec. 2010, doi: 10.1016/J.SUC.2010.08.009.
- [62] V. C. Nolan, J. Harrison, and J. A. G. Cox, “Dissecting the Antimicrobial Composition of Honey,” *Antibiotics*, vol. 8, no. 4, p. 251, 2019, doi: 10.3390/antibiotics8040251.

- [63] M. S. Osato, S. G. Reddy, and D. Y. Graham, "Osmotic effect of honey on growth and viability of *Helicobacter pylori*," *Digestive diseases and sciences*, vol. 44, no. 3, pp. 462–464, 1999, doi: 10.1023/A:1026676517213.
- [64] P. Sowa, D. Grabek-Lejko, M. Wesołowska, S. Swacha, and M. Dżugan, "Hydrogen peroxide-dependent antibacterial action of *Melilotus albus* honey," *Letters in applied microbiology*, vol. 65, no. 1, pp. 82–89, Jul. 2017, doi: 10.1111/LAM.12749.
- [65] N. N. Cokcetin *et al.*, "The Antibacterial Activity of Australian *Leptospermum* Honey Correlates with Methylglyoxal Levels," *PloS one*, vol. 11, no. 12, Dec. 2016, doi: 10.1371/JOURNAL.PONE.0167780.
- [66] Z. H. Israili, "Antimicrobial properties of honey," *American Journal of Therapeutics*, vol. 21, no. 4, pp. 304–323, 2014, doi: 10.1097/MJT.0b013e318293b09b.
- [67] R. Wasfi, W. F. Elkhatib, and A. S. Khairalla, "Effects of Selected Egyptian honeys on the cellular ultrastructure and the gene expression profile of *Escherichia coli*," *PloS one*, vol. 11, no. 3, Mar. 2016, doi: 10.1371/JOURNAL.PONE.0150984.
- [68] E. Mavric, S. Wittmann, G. Barth, and T. Henle, "Identification and quantification of methylglyoxal as the dominant antibacterial constituent of Manuka (*Leptospermum scoparium*) honeys from New Zealand," *Molecular nutrition & food research*, vol. 52, no. 4, pp. 483–489, Apr. 2008, doi: 10.1002/MNFR.200700282.
- [69] P. H. S. S. Kwakman and S. A. J. J. Zaat, "Antibacterial components of honey," *IUBMB Life*, vol. 64, no. 1, pp. 48–55, 2012, doi: 10.1002/iub.578.
- [70] J. Majtan, "Honey: An immunomodulator in wound healing," *Wound Repair and Regeneration*, vol. 22, no. 2, pp. 187–192, 2014, doi: 10.1111/wrr.12117.
- [71] J. Lu *et al.*, "Honey can inhibit and eliminate biofilms produced by *Pseudomonas aeruginosa*," *Scientific reports*, vol. 9, no. 1, Dec. 2019, doi: 10.1038/S41598-019-54576-2.
- [72] J. Lu *et al.*, "Manuka-type honeys can eradicate biofilms produced by *Staphylococcus aureus* strains with different biofilm-forming abilities," *PeerJ*, vol. 2, no. 1, 2014, doi: 10.7717/PEERJ.326.
- [73] L. Zhang *et al.*, "The Effect of Exit-Site Antibacterial Honey Versus Nasal Mupirocin Prophylaxis on the Microbiology and Outcomes of Peritoneal Dialysis-Associated Peritonitis and Exit-Site Infections: A Sub-Study of the HoneyPot Trial," *Peritoneal dialysis international: journal of the International Society for Peritoneal*

*Dialysis*, vol. 35, no. 7, pp. 712–721, Dec. 2015, doi: 10.3747/PDI.2014.00206.

- [74] A. B. Jull, N. Walker, and S. Deshpande, “Honey as a topical treatment for wounds,” *The Cochrane database of systematic reviews*, vol. 2013, no. 2, Feb. 2013, doi: 10.1002/14651858.CD005083.PUB3.

# Mother as Mother: Welcoming the Society Era of 5.0

Mohd. Nasir<sup>73</sup>

## Introduction

The society era of 5.0 makes humans rich materially but spiritually poor. Advances in technology make all the fulfilment of the necessities of life very easy. Just by sitting at home and with your fingertips, all your needs will be fulfilled. The world becomes limitless, all events, information and life needs can be fulfilled anytime, anywhere and by anyone. Through the society era of 5.0, the human-centred and technology-based society will become a new wisdom that is inevitable. This transformation will help people live a more meaningful life, but it requires a balance between the economy and the social life of the community.

In addition to having a positive impact, this era also had a negative impact, including; buying and selling transactions carried out online, without face-to-face, open up opportunities for certain parties to commit fraud that can harm others, such as several cases that have occurred in Indonesia [1], then the society era of 5.0 has given an unwanted impression in the world of education, it is feared that there will be a moral decline [2], a consumptive, pragmatic culture and likes to choose instant ways to encourage children to be impatient and less humanistic.

The continuous use of computers as a medium of communication and transactions makes children individualistic and communication is empty and various kinds of information become public consumption of children without parental control. Pornography, gambling, online game addiction, underage online prostitution, the spread of fake news, violence and many others become free public spectacle for children, so this has an impact on the moral decline of children.

On the other hand, the pandemic that has hit the world has also forced the acceleration and quantity of internet use. Learning that takes place online, makes schools unable to solve children's moral problems, affective aspects are neglected. So in conditions like this, it is parents who must take this noble role. [3]. Although the transfer of knowledge can be replaced by technology, the application of soft skills and hard skills cannot be replaced with any

---

<sup>73</sup> Institut Agama Islam Negeri Langsa, mohd.nasir@iainlangsa.ac.id

sophisticated tools and technology [4], only by adhering to the noble values of the nation originating from religious teachings and local wisdom of the archipelago, children will not be caught in an identity crisis in a new era, Society Era of 5.0. So this is where the important role of parents, especially mothers, functions as the first and main agent in the formation of children's character in the society era of 5.0.

## **Discussion**

### **Society Era of 5.0**

The 2019 World Economic Forum in Dawos has provided a new idea that emerged from Japanese civilization, known as Society 5.0. Simply put, this idea is a response to the 4.0 era known as the industrial revolution. The 4.0 Era makes more use of technology, but in the society era of 5.0, humans are more involved by balancing technological advances where ordinary humans solve problems through systems that have been connected both through the virtual world and the real world [7]

The society era of 5.0, according to Japanese Prime Minister Shinzo Abe said that "it is no longer capital that is the movement but data that will connect and move everything, where this data can help social inequality that occurs, can harmonize education to rural areas, can facilitate all medicine will be easily accessible in the Era of 5.0 [7]

Society is a very brilliant idea where humans can complete their tasks very easily with the help of technology, but how about in the world of education which is not just a transfer of knowledge but also transfers of character, so to welcome such a big change, capital is strongly needed [8]

In facing the society era, the main step taken by educators is to equip themselves with capital, Bourdieu said that capital is very essential to be able to change habitus, because the realm of social struggle will be won by those who have capital, and capital can make a realm (arena) has meaningful powers [9], education in Society Era would have had the meaning desired if the agent had the capital.

### **Mother as Mother**

The mother is the first agency in the formation of the child, namely educating the child as she wants, this is in line with the hadith stating "the mother is the first school for the child", the mother is the main actor in the world of education who will build fundamentals for her children to which direction she wants [10]. According to Gidden,



all humans are purposive agents, because every individual human being has a tendency in his life, he has a reason for his actions and then that reason is elaborated continuously so that it becomes a goal, intends and has a motive [11]

Giddens states that the agency has the ability to act and has the autonomous right to carry out the intended purpose, so in the family the mother has both of these things as a hadith states about the main education for a mother. Mother who acts as an agency and main actor in the world of education has awareness of how important role she has for the growth and development of a child. Giddens distinguishes three internal dimensions of actors, namely unconscious motivations, practical awareness (practical consciousness), and discursive consciousness [6] Unconscious Motives.

This unconscious motivation is a desire or need that has the potential to direct action, but not the action itself [12]. In simple language, the author interprets the meaning of this unconscious motivation is that what we have done is a merit that we will get even though we do it without expecting what is rightfully ours. For example, someone who performs worship to his God, of course he does not expect anything at this time except when on the Day of Judgment later he will get a reward for the worship he does.

Unconscious motives that occur in the main agency when carrying out an action, the agent has no hope that the action will return to him, only indirectly the agent can feel the benefits of his unintentional action from his action when the action has achieved its goal. We give an example of this unconscious motivational act in the world of education, where the mother, who acts as the first agency, certainly does not hope that the education she gives to her children will be useful for her, but what she has given to her children will come back to her.

For example, let's say a mother who gives spiritual education to children when she grows up will give the same thing to her mother and vice versa, this is certainly in accordance with what is said in the Muslim holy book "Whoever does good as heavy as a dzarrah (very small) he will see (a reply) it. And whoever commits a crime as heavy as a dzarrah, surely he will see (a reply) it too. (Qs Al- Zalzalah 7-8)" [13] the verse provides an understanding of the evaluation of education not only assessing an activity spontaneously and incidentally, but is an activity to assess something systematically planned based on comprehensive and clear goals. [14]

### **Practical Consciousness**

Practical consciousness (knowledge ability) is an awareness that must be possessed by an agent - with this awareness - the first thing that is expected is that an actor is able to give character, then this awareness is formed through the knowledge he has, that knowledge is applied to produce what he wants [11] For example, a teacher who has knowledge about the importance of praying on time, then he will apply a method so that the student wants to pray on time.

This kind of awareness is expected to exist in a mother in facing the society era, where this awareness will be able to create mothers like Al Khansa Tumadhar binti Amr bin Al Harist, or Nusaibah Binti Ka'ab who is able to educate her generation to have good character and at the same time be able to give success to Islam [15].

Knowledge meant in practical consciousness does not define all the situations an actor may encounter and neither can she. But knowledge reflects a general capacity to respond to and influence an infinite continuum of social circumstances, as evidence of course not all mothers in today's world want to make their children a warrior of Islam, but there are also those who want their children to become fighters for Islam but she cannot. do it because of the limitations he has.

The Society Era that puts forward a data-based world can provide pragmatism education, pragmatism is not always profitable and with it will make her far from persistence, this can be seen in the life of Thomas Alva Edison he is considered a very stupid child to the point that his teacher refuses to teach him and sends him home. He went to his mother, but today we can enjoy the light of the lamp, all because of the persistence of Edison's mother who is always sincere to train and teach him at home when no one in the school is willing to accept him.

### **Discursive Consciousness**

Discursive awareness in a person cannot be separated from the agent who determines how consistent she is with the role she carries out where the agent when she has carried out her role she gets useful benefits for herself [6] as an example of a student who is always obedient and obedient to his teacher he has the realization that knowledge will be easily obtained when he treats a teacher. (The author's observations at a Salafiah Islamic Boarding School in Aceh).

Discursive awareness gives awareness to the agent without any lafadz (pronunciation) [12], this has inspired their mothers to have discursive awareness, the first stage of this awareness of the child, when the child is in the womb they are willing to recite the Al-Quran because they think this is a early childhood education which they hope that with this the child will become pious with the verses that are heard, such as the confession of Fatimah Zuhra's mother:

There are so many benefits of reading the Qur'an for those of us who are pregnant. Because by reading the Qur'an, Allah gives us mercy and I believe that by reading the Qur'an Allah will make the child in our womb become a good child.

This awareness is not only done by Muslims, this is also done by the Jewish community in general. In a journal entitled Jewish Prenatal Education and Its Relevance to Education, it is stated that the Jews began to teach children when the child was still in the womb by the mother playing the piano or solving math problems that were considered difficult, teaching that was difficult. they give it to the child before the child speaks let alone understands reading and writing [16]. This illustrates that even though a child does not know anything, of course learning can already be applied to a child, this is also contained in the Al-Quran "And Allah brought forth you from your mother's womb knowing nothing, and He gave you hearing, sight and heart, so that you may be grateful" (Qs An-Nahlu : 78).[13]

The dynamics of discursive awareness carried out by Muslim and non-Muslim mothers have differences, on which can be seen from the way of educating them while in the womb, non- Muslim mothers choose to play the piano while Muslims choose to recite the Qur'an, where discursive awareness is carried out by Muslim mothers because they believe in their holy book when reading it will get grace for those who read and those who listen. This is also supported by a study conducted by Yuliani Budiarti and Makiah, on which reading the Al-Quran can reduce anxiety levels for pregnant women and can increase the immune system, it can make a therapy even though people who read it do not understand the meaning of what is read [17]. Abu Hurairah RA said that the Messenger of Allah said, "It is not a people who gather in one of the houses of Allah, they read Allah's Book and teach it to each other, except that happiness is sent down upon them, mercy showers them, the angels flock to them, and Allah (SWT) mentions them among the (angels) who are with him." [18]

The society era really needs discursive awareness from budding agents (mothers) in forming spiritually rich regeneration because if this awareness is not inspired in a mother they will find it difficult to get what the apostle Al-Jannatu Tahtaa aqdaamil Ummahaat has said: "Heaven is in under the soles of mother's feet" Is there any glory that exceeds all this for women [19]

The society era raises discursive awareness from mothers to always provide education that prioritizes character for the child, because the economic and technological wealth created by the society era does not guarantee a mother can be happy and treated well by a child, but if the child has spiritual wealth, she (mother) will have extraordinary happiness, this has been exemplified by Uwais Al-Qrnain who was willing to carry his mother to Mecca for Hajj with a distance of thousands of kilometres because of his mother who has been able to provide spiritual wealth for him. What is done by the agent as the author described above, Giddens calls it moral.

The next stage of discursive awareness carried out by a mother to be able to shape the character of the child is through prayer where every mother has and has a prayer for her child, what this mother does comes from the knowledge she has as Gidden said that the agent who acting as an actor in creating the object by not just doing scratching in a simple way, but first describing the sources that have been there before. That is where the mother in carrying out prayers to give good character to the child is clearly stated in the hadith "pray for blessings and blessings for children, and ask for protection of children from the temptations of Satan (Hr At Tarmidzi) [20].

## **Conclusion**

The society era of 5.0 made changes in the social structure of society in totality and superfast. This is a challenge for the world of education in the formation of children's character. At the same time, it is a great opportunity to give back to the main role for mothers as the first and main educator in an effort to shape the social structure of society in the society era of 5.0. As an educational agent in the family, the mother will internalize the character for the child operating through three interconnected consciousnesses, namely; unconscious motives, practical consciousness and discursive consciousness.

## **References**

- [1] M. Kamran and M. Maskun, "Penipuan Dalam Jual Beli Online: Perspektif Hukum Telematika," *Balobe Law J.*, vol. 1, no. 1, p. 41, 2021, doi: 10.47268/balobe.v1i1.501.
- [2] N. Fatiha and G. Nuwa, "Kemerosotan Moral Siswa Pada Masa Pandemic Covid 19: Meneropong Eksistensi Guru Pendidikan Agama Islam," *Kemerosotan Moral Siswa Pada Masa Pandemic Covid*, vol. 19, pp. 1–17, 2020.
- [3] N. Fitria and S. Sholehuddin, "Peran Orang Tua Dalam Pembelajaran Selama Pandemi COVID-19 di Kelas 3 SD Labschool FIP UMJ," *Pros. Semin. Nas. Penelit. ....*, pp. 1–10, 2020, [Online]. Available: <https://jurnal.umj.ac.id/index.php/semnaslit/article/view/8844>.
- [4] E. N. Faulinda and 'Abdu Aghni Rizqi Ni'mal, "Kesiapan Pendidikan Indonesia Menghadapi era society 5.0," *Edcomtech J. Kaji. Teknol. Pendidik*, vol. 5, no. 1, pp. 61–66, 2020.
- [5] S. P. M. P. Dr. Drs. I Wayan Suwendra and S. P. M. P. I. B. Arya Lawa Manuaba, *Metodologi Penelitian Kualitatif dalam Ilmu Sosial, Pendidikan, Kebudayaan dan Keagamaan*. Nilacakra, 2018.
- [6] A. Giddens, *The Constitution of Society Outline of the Theory of Structuration*. California: University of California Press, 1986.
- [7] Y. Puspita, Y. Fitriani, S. Astuti, and S. Novianti, "Selamat Tinggal Revolusi Industri 4.0, Selamat Datang Revolusi Industri 5.0," *Pros. Semin. Nas. Pendidik. Progr. Pascasarj. Univ. PGRI Palembang*, pp. 122–130, 2020, [Online]. Available: <https://jurnal.univpgri-palembang.ac.id/index.php/Prosidingpps/article/view/3794/3565>.
- [8] K. N. S. Rahayu, "Sinergi pendidikan menyongsong masa depan indonesia di era society 5.0," *Edukasi J. Pendidik. Dasar*, vol. 2, no. 1, pp. 87–100, 2021, [Online]. Available: <https://stahmpukuturan.ac.id/jurnal/index.php/edukasi/article/view/1395>.
- [9] M. Adib, "Agen dan Struktur dalam Pandangan Piere Bourdieu," *BioKultur*, vol. I, no. 2, pp. 91–110, 2012, [Online]. Available: <http://journal.unair.ac.id/download-fullpapers-01> Artikel AGEN DAN STRUKTUR DALAM PANDANGAN PIERE BOURDIEU Revisi 20 Okt 2012.pdf.
- [10] M. S. A. Lubis and H. S. Harahap, "Peranan Ibu Sebagai Sekolah Pertama Bagi Anak," *J. Ilmu Pendidik*, vol. 2, no. 1, pp. 6–13,

- 2021, [Online]. Available: <https://jurnal-lp2m.um naw.ac.id/index.php/JIP/article/view/772>.
- [11] I. Craib, *Anthony Giddens (Routledge Revivals)*. Taylor & Francis, 2011. [12] S. Literate and J. I. Indonesia, "Prof. Miriam Budiardjo," pp. 274–282, 2020.
- [12] A. Sahil, *Indeks Al-Quran: Panduan Mudah Mencari Ayat dan Kata dalam Al-Quran*. Mizan Pustaka, 2007.
- [13] Rahmat, "Evaluasi Pembelajaran Pendidikan Agama Islam," *Bening Pustaka*, vol. 2, no. 2, pp. 1–212, 2019, [Online]. Available: [https://books.google.co.id/books?id=5GTtDwAAQBAJ&printsec=frontcover&dq=islam,+media+sosial+dan+pendidikan&hl=id&sa=X&ved=2ahUKEwiczTPiZvtAhUn8HMBhbBiD\\_EQ6AEwCXoECAMQAg#v=onepage&q=islam%2Cmedia+sosial+dan+pendidikan&f=false%0Ahttps://books.google.co.id](https://books.google.co.id/books?id=5GTtDwAAQBAJ&printsec=frontcover&dq=islam,+media+sosial+dan+pendidikan&hl=id&sa=X&ved=2ahUKEwiczTPiZvtAhUn8HMBhbBiD_EQ6AEwCXoECAMQAg#v=onepage&q=islam%2Cmedia+sosial+dan+pendidikan&f=false%0Ahttps://books.google.co.id).
- [14] Muhammad Lili Nur Aulia, *Sentuhan Cinta Ibu Sosok Istimewa di Balik Tokoh Hebat Islam*. Indonesia: Gema Insani, 2020.
- [15] M. Kasana and A. N. Sari, "Pendidikan Prenatal Yahudi dan Relevansinya dengan Pendidikan Islam," *Acad. J. Multidiscip. Stud.*, vol. 1, no. 2, pp. 197–210, 2017.
- [16] Y. Budiarti and Makiah, "Murottal Al Qur ' an Therapy Effect on Anxiety Level of Third Trimester Primigravida Pregnant Women," *J. Citra Keperawatan*, vol. xx, no. x, pp. 89– 99, 2018.
- [17] A. Daud, *The third correct tradition of the Prophetic Sunna (Sunan Abu Dawud) 1-5 VOL 1: 1 ج 1: 1 يزوي للنزاي برع [ 5/1 نيس بيدواد راد بئكلا قهمللا*. Dar Al Kotob Al Ilmiyah 2008.
- [18] H. Faizin, "Apakah Surga Berada Di Bawah Telapak Kaki Ibu?," *Hikmah*, vol. XIV, no. 2, pp. 1–26, 2018, [Online]. Available: <http://journal.alhikmahjkt.ac.id/index.php/HIKMAH/article/view/105>.
- [19] A. H. I. H. al-Asqalani, *Terjemah Kitab Bulughul Maram: Hadist Fikih dan Akhlak*. Shahih, 2016.

# Development of Audio Visual Media Based on Macro Media Flash 8 on Dayang-Dayang Dance Learning

Mohzana<sup>74</sup> , Hary Murcahyanto<sup>75</sup> , Linda Laili Harjuni<sup>76</sup>

## Introduction

The teaching and learning process is essentially a communication process, namely the process of delivering messages from the source of the message through a certain channel to the recipient of the message.[1]–[3]. Teaching and learning activities are carried out every day, it is the life of a class, where teachers and students are interrelated in carrying out activities that have been planned by the teacher. [4]–[7]. In communication, of course, what is expected is reciprocity between teachers and students so that the learning process becomes active and effective.[4], [8], [9].

School is one of the places where the learning process occurs because there are educational facilities to channel various aspects of educational science that have been neatly arranged in learning designs in accordance with applicable and systematic curriculum standards, so that schools are the place for formal learning and teaching processes according to the rules and responsibilities. educators and students. [10]–[13]. The process is supported by several components that support important learning interactions in the world of education, such as students, teachers.[14]–[16]. Other components such as objectives, materials, media, tools, methods and evaluation. By paying attention to some of these components, it will certainly facilitate the formation of students' abilities in honing their skills. [14], [16]–[18].

Learning on cultural arts subjects for example. In all schools, this learning is mandatory in the learning curriculum that is prepared, because the function of this subject is to introduce the artistic identity of the area.[2], [19]–[21]. Lombok, for example, there are various types of traditional arts that are owned either in the art of music or dance. To carry out this learning, of course, requires teaching staff who have special abilities or skills in their fields so that the skills of students and students can be honed, but seeing the development of

---

<sup>74</sup> Dosen Manajemen Pendidikan Universitas Hamzanwadi

<sup>75</sup> Dosen Manajemen Pendidikan Universitas Hamzanwadi

<sup>76</sup> Alumni Program Studi Pendidikan Seni Drama Tari dan Musik Universitas Hamzanwadi

education now teachers are required to be creative in mastering technology as a support in developing learning media made, moreover the learning process much different from the previous condition because it collided with a very deadly virus, namely the corona virus disease 19 (covid 19)

The effect of these conditions is the demands of a teacher in carrying out the learning process using an online system or learning online. [22]–[24]. Of course, the role of a teacher as a developer of knowledge is very large to choose and implement appropriate and efficient learning for students and be able to provide an understanding that is quickly understood, of course, by utilizing technological developments and other supporting facilities.

An alternative that should be done in creating a pleasant learning atmosphere is the use of learning media. Learning media serves as a means to convey information so that students have the same perception of teaching materials.[14], [16]. Media also helps abstract thinking processes and can develop psychomotor skills in learning. Or it is the same with social media which is one of the important contributing factors that gives way to new ideas and innovations[26],[27], [28],[29].

One of the learning media that can be used by teachers in this case is the use of macro media flash 8 applications as an alternative to answer the conditions of the current teaching and learning system. Macro media flash application is one of the applications for multimedia graphics and animation programs created by the Macromedia company for the purposes of making interactive web applications and animations that are developing at this time. This program is widely used to create games, cartoons, presentations and interactive learning models.

Based on the results of observations made on April 15, 2021 at SMAN1 Lauhan Haji, in the subject of cultural arts there are three types of arts that are taught including the art of dance. this lesson is not able to teach or practice directly the material being taught because the scientific background they have is in the field of mathematics so that the learning method used is conventional, meaning that it is enough to give students the name of the local dance and then they are asked to find their own form of dance movement. by Gabriel, a teacher who teaches arts and culture subjects in class X (ten) said that it is very difficult to teach cultural arts subjects either directly in practicing them or using media to support the teaching and learning process in these subjects so that students feel bored while doing the learning



process.

From the description above, the researcher is interested in developing audio visuals by using the macro media flash 8 application in dance lessons. With the aim of providing understanding to teachers related to the development of application-based media and its benefits, it can make it easier for students and students to learn the forms and techniques of movement in dance as the main material in learning arts and culture subjects.

## **Results and Discussion**

### ***Product Development Results***

Based on the development procedure described earlier, in the process of developing audio-visual media using macro media flash 8 in Dayang Dayang Dance, there are several stages of development including:

1. The needs analysis stage; Before carrying out the design of learning media development, the first step that must be done in this case is a field study (observation) and then a literature study.

- a. Problem analysis

At this stage, an investigation of the problems that arise in learning activities in the field is carried out and then identify possible solutions that can be used to overcome these problems. Based on the observations, it is known the following problems:

- 1) In the arts, culture and arts (SBK) subjects, there are lessons that talk about the art of traditional dance. Then the traditional dance that is taught is the lady-in-waiting dance. In the learning process, this subject is more practical, it is necessary to develop learning media that are more creative and innovative but interactive
- 2) Students are less enthusiastic or less attentive when taking lessons, it is necessary to develop media that is attractive and interactive and has an attractive appearance so that students have motivation and interest in learning to learn.
- 3) Lack of creativity of teachers in using learning media, causing students to feel bored
- 4) Learning media still looks monotonous (lecture method)
- 5) The designed learning media is expected to improve student learning outcomes and achievement in the traditional music extracurricular of Gendang Beleg.

- b. Media content analysis

The preparation of learning media requires an analysis of the learning objectives to be achieved and an analysis of the content of the media. The content of this learning media is referring to traditional dance lessons, especially the ladies-in-waiting dance as traditional dances in Lombok

## 2. Product Design Stage

In the design process of learning media design using macromedia flash 8, in this case the display design needs a design sketch that is used to describe the making of the media. The sketch is formed in a storyboard. The sketch consists of:

### a. Opening page view

On this page the screen will display photos of researchers who are used directly as models in this media. there is a loading icon which is used as the process of opening this media with the backsound directly using the dance gending of the ladies-in-waiting.

### b. Choice of ladies-in-waiting dance menu

On this page there is an animated image display of icons to make it interesting and there is a button between the icons is an icon that describes learning indicators, learning objectives, materials and finally an icon that describes quizzes. The following is a sketch of the ladies' dance menu choices:

#### 1) Menu of basic competencies and indicators

This section will explain what the basic competencies and indicators for learning in traditional dance are taught. The following is an example of a sketch in this section

#### 2) Learning objectives menu

This section contains the description of the learning objectives that are adjusted to the learning indicators and the basic competencies of the learning. The following is an example of a sketch in this section illustrated

#### 3) Material Menu

This section contains material related to the movement techniques of the ladies-in-waiting dance. In the explanation process related to the movement technique, it will be explained one by one which is practiced directly and then directly explain the parts of the movement. The following is an example of a sketch in this section which can be illustrated as follows:

##### a) Menu "quiz"

to evaluate the learning outcomes of traditional

drumming beleq music which contains items related to the material that has been presented previously. To start the quiz, participants first fill in the identity column then in the password column write their name and name then click the "start" menu to start the evaluation. To answer the quiz questions, participants just need to choose one answer that is considered correct, by clicking the ok button in the upper right corner and at the end of the quiz, the participant's score will appear automatically.

b) Profile section

This section will explain the profile of the researcher clearly consisting of:

i. Implementasi

The implementation process is the stage to realize the designs that have been previously made, where previously sketches or rough outlines are mapped into designs that are more real and suitable for use as learning media. In the implementation process, macromedia flash software is used because the tools panel in the software is very supportive for making animations, making buttons. The following are several pages of implementation of traditional dance learning, for more details, please see the attachment page

- Opening page display implementation

On the implementation of this page the screen will display an animation of the title of the learning media, then a photo of the researcher who is used as a direct model in this study, then before starting on the main menu there is a loading icon which is given back sound using the original music from the dance. The next menu starts when the moving icon on the loading icon on the video finishes playing.

- Implementation on the ladies-in-waiting dance menu

In this section is the initial menu before the start of learning begins. In this section there is a menu of choices including the learning indicators menu, learning objectives menu, material menu, quiz menu and finally the profile menu.

- Implementation on the menu of basic competencies

This section is the initial menu for the learning

process to begin, because the menu displayed in it contains the basic competencies of learning in dance lessons, especially traditional dance ladies-in-waiting, there are two learning indicators in this section which can be seen directly in the original image displayed.

- **Implementation in the Learning Objectives Section**  
In this section there is a section on learning objectives. The learning objectives described are in accordance with what are the basic competencies in the learning. The following is the original image displayed on this learning media
- **Implementation in the material section**  
In this section there are two parts, the first is a section that explains the main material, then in the second there is an explanation video related to the movement techniques in the dance. In this section, the model used is a direct researcher, the goal is to organize the learning media created.
- **Implementation in the quiz section**  
In this section, the evaluation and evaluation results are automatically filled in with the number of values obtained from the answers given to the questions presented.

From the original image presented above, first students are asked to fill in the name in the name column, then fill in the name as a password in the password section, then to start the quiz, just click the word "start". After the picture appears, the students just click on which answer they think is the most correct, after clicking on it, to start the next question, just click the "ok" button in the upper right corner. After answering all the questions provided in the quiz section, the last image appears. This section will display the results of the score or score after answering the questions provided. If a student gets a score above the standard passing grade, the column in the description section of the value result will automatically write the word "PASS"

ii. Coding

Coding is a programming language used to execute

commands to coded objects. In macromedia flash 8 the programming language used is also called action script.

iii. Test

This stage is the stage where this learning media is checked. This stage is more about checking the navigation buttons for errors in giving orders, inaccessible navigation, checking for errors in the material, writing errors. This stage is checked by the maker and then checked by three media experts, and three material experts to ensure that the display design, programming, and learning materials are appropriate and suitable for use as learning media.

iv. Publishing

This stage is the stage where the media design that has been created is exported from \*.fla files to \*.swf, and \*.exe files, to make it easier without having to install macromedia flash 8 software to open it. However, because to run the \*.swf file you need a flash player, the file used is the \*.exe file, but these two files will be included in the package in the form of a learning CD.

v. Packaging

At the packaging stage, the required files, either swf or exe, are put into a folder. Then the folder is inserted into the CD. This is done to make it easier for users to use learning media.

### **Efektifitas Pengembangan Media Audio Visual Berbasis Macro Media Flash Pada Pembelajaran Tari Dayang-Dayang**

Audio-visual development media using macro media flash 8 is a medium that contains tutorials for the ladies-in-waiting dance and explanations. The development of audio-visual media using macro media flash8 is carried out as an effort to produce media products that are suitable for use in learning dance. Developers choose to make videos because they are adapted to existing learning conditions. currently the learning conditions are carried out using online methods due to the current condition of the rampant corona virus 19 pandemic.

This development research is a step used to produce media that can attract students' interest in learning to make students more enthusiastic in learning so as to improve students' abilities and understanding of multiplication and division material. In this development research using the Bord and Gall development model

which has 10 stages which are simplified into 7 stages, namely: 1) Research and data collection stage, 2) Design planning, 3) Product development, 4) Expert validation test, 5) Product revision, 6) Field trials, 7) Final product revisions. Before the trial was conducted, the media was validated by 2 experts, namely 1 media expert and 1 material expert.

### ***Media Expert Validation***

The results of the media expert validation show validation from the media side of the "good" category and suitable for research with a total score of 56 with an average of 4. The assessment obtained can be detailed as follows: 1) The text can be read well and gets a score of 4 because each text on the slides are legible, 2) The media layer display gets a score of 4 because each layer doesn't watch, 3) The selection of background graphics gets a score of 4 because the colors used are in accordance with the theme, 4) Text size and typeface get a score of 4 because the typeface used matches the character. product titles and fonts used, 5) Illustrations, colors, supporting images get a score of 4 because they are in accordance with the product and material raised, 6) Animated presentations get a score of 4 because the animated characters used are in accordance with the developed product, 7) Video presentations get a score 4 due to the clarity of the display, the suitability of the video content with the product g is developed, 8) The sound is heard clearly and gets a score of 4 because each explanation of the type of motion in the delivery of the description sounds clear, 9) The carrying capacity of the accompaniment music gets a score of 4 because the music used is in accordance with the dance accompaniment, 10) The order of media presentation gets a score of 4 due to the delivery of the material explained in accordance with the order of the discussion, 11) Clarity of the description of the material gets a score of 4 due to the suitability of the content conveyed with the discussion, 12) Navigation gets a score of 4 because there is a match between the intended section, 13) Placement and use get a score of 4 because each part of the content of the material corresponds to the part of the content in the material, 14) Button gets a score of 4 due to the use of symbols in the suitability of linear material.

### ***Material Expert Validation***

The validation results from the media show the validity of the material in the "Very good" category and is suitable for research with

a total score of 60 with an average of 4. The assessment obtained can be detailed as follows: 1) the relevance of the material with the syllabus gets a score of 4 because it is in accordance with the material what is taught is traditional local dances, 2) the accuracy of the material with competency standards with a score of 4 due to the adjustment of the material with competency standards in the learning plan, 3) the sequence of presentation of the material gets a score of 4 because the learning process is carried out in accordance with what is shown in the order on the developed media, 4) the clarity of the structure presented gets a score of 4 because the explanation process carried out on the media developed is structured so that it is quickly understood by students and students, 5) The accuracy of the use of language gets a score of 4 because the explanation process carried out is in English. sa used which is easy to understand, 6) the support power of the learning program gets a score of 4 because the media developed is a medium that everyone can learn, meaning that the level of difficulty can even be said to be non-existent, 7) the material in accordance with the formulated objectives gets a score of 4 because in the explanation process carried out between the existing material and the appropriate learning objectives, 8) the material according to the student's ability to get a score of 4 because in the learning process carried out between the syllabus, basic competencies to the material being taught is a learning unit that has been adapted to students' abilities, 9) the material that can be studied gets a score of 4, this is because the material being taught talks about regional dances, 10) The accuracy of the examples of images given for the clarity of the material gets a score of 4 due to the visualization in the development of the media developed according to the example of t-movement. Arian ladies-in-waiting, 11) Coverage of material related to the sub-themes discussed gets a score of 4 because the learning process is carried out with structured media developed, 12) Media in accordance with the truth of the material gets a score of 4 because the media is developed based on the syllabus and plan learning that is made, 13) The material is easy to understand and gets a score of 4 because the grammar used can be understood by students, 14) The depth of the material presented gets a score of 4 because the material taught is adapted to the material about traditional dances of the local area, 15 ) The order of presentation of material from general to specific patterns gets a score of 4 because in the explanation given to the developed media, starting from a new general understanding of dance to a regional understanding of dance.

After the validation results are obtained, further trials can be carried out. In this study, it was conducted at SMAN 1 Labuhan Haji during the field trial research, getting a score of 26.11 consisting of 17 students. In general, the use of macromedia flash 8-based audio-visual media is very effective because it can motivate students to enjoy learning dance. The motivation of students in learning regional dance is because the media developed besides explaining the name of the movement of each dance is directly exemplified or practiced by students and students, so that is what gives them speed in learning the art of traditional dance or dance ladies-in-waiting.

## **Conclusion**

Based on the results of research and discussion conducted, it can be concluded that:

1. Development of audio-visual media using macro media flash 8 at the needs analysis stage there are several observations which are the needs of problem analysis including the lack of interactive learning process carried out, the use of media used is less creative, causing learning to be monotonous, then the content needs analysis The media refers to the learning of traditional dance, especially the ladies-in-waiting dance as a traditional dance in Lombok. Furthermore, at the product design stage, this media development uses a design sketch called a storyboard.
2. The effectiveness of the developed media, the feasibility of which is developed quantitatively and qualitatively in the learning process. This feasibility is based on the feasibility test of media experts getting a score of 4 with the criteria of "Good". The feasibility test of the material expert got a score of 4 with the "Good" criteria. The feasibility test of users who got a score of 26.11 with the criteria "very good"

## **References**

- [1] A. Ambarita, "Manajemen pembelajaran," *Jakarta: Depdiknas*, 2006.
- [2] A. Sudrajat, "Pengertian pendekatan, strategi, metode, teknik, taktik, dan model pembelajaran," *Online*(<http://smacepiring.wordpress.com>), 2008.
- [3] R. Ramlan and J. Permana, "PENDIDIKAN BUDAYA DAN KARAKTER BANGSA PADA PROSES PEMBELAJARAN SENI TARI & DRAMA," *Pendas : Jurnal Ilmiah Pendidikan Dasar*. Universitas Pasundan, 2016, doi: 10.23969/jp.v1i1.200.



- [4] R. Johar and L. Hanum, *Strategi belajar mengajar*. Deepublish, 2016.
- [5] W. Gulo, *Strategi Belajar Mengajar (Cover Baru)*. Grasindo, 2008.
- [6] S. Am, "Interaksi dan motivasi belajar mengajar," *Jakarta Raja Graf. Persada*, 2011.
- [7] A. Emda, "Kedudukan motivasi belajar siswa dalam pembelajaran," *Lantanida J.*, vol. 5, no. 2, pp. 172–182, 2018.
- [8] B. Suryosubroto, "Proses Belajar Mengajar di Sekolah Edisi Revisi," *Jakarta PT Rineka Cipta*, 2009.
- [9] A. Nugrahaeni, I. W. Redhana, and I. M. A. Kartawan, "Penerapan model pembelajaran discovery learning untuk meningkatkan kemampuan berpikir kritis dan hasil belajar kimia," *J. Pendidik Kim. Indones.*, vol. 1, no. 1, pp. 23–29, 2017.
- [10] W. Winarso, "Dasar Pengembangan Kurikulum Sekolah," 2015.
- [11] H. E. Mulyasa, "Implementasi Kurikulum Tingkat Satuan Pendidikan (KTSP)," *Kemandirian Guru dan Kepala Sekolah, PT Bumi Aksara, Jakarta*, 2010.
- [12] S. Bahri, "Pengembangan Kurikulum Dasar dan Tujuannya," *J. Ilm. Islam Futur.*, vol. 11, no. 1, pp. 15–34, 2017.
- [13] E. Mulyasa, "Guru dalam implementasi kurikulum 2013," *Bandung PT Remaja Rosdakarya Offset*, 2014.
- [14] R. Rohani, "Media pembelajaran," 2019.
- [15] A. Arsyad, "Media pembelajaran." Jakarta: PT Raja grafindo persada, 2011.
- [16] A. Aurora and H. Effendi, "Pengaruh Penggunaan Media Pembelajaran E-learning terhadap Motivasi Belajar Mahasiswa di Universitas Negeri Padang," *JTEV (Jurnal Tek. Elektro dan Vokasional)*, vol. 5, no. 2, pp. 11–16, 2019.
- [17] R. Asyhar, "Kreatif mengembangkan media pembelajaran," 2021.
- [18] E. N. Thaib, "Hubungan Antara prestasi belajar dengan kecerdasan emosional," *J. Ilm. Didakt. Media Ilm. Pendidik. dan Pengajaran*, vol. 13, no. 2, 2013.
- [19] W. Sanjaya, "Perencanaan & desain sistem pembelajaran," *Jakarta Kencana Prenadamedia Gr.*, 2008.
- [20] S. Suharto, "Pengembangan materi dan kegiatan pembelajarannya dalam kurikulum tingkat satuan pendidikan bidang seni musik," *Harmon. J. Arts Res. Educ.*, vol. 8, no. 3, 2007.
- [21] H. Pamadhi, *Pendidikan seni: hakikat kurikulum pendidikan seni, habitus seni, dan pengajaran seni anak*. UNY Press, 2012.
- [22] N. Nurhayati, M. E. Purnomo, and S. Subadiyono, *Pengaruh Online Peer Editing Berbasis E-Learning Terhadap Kemampuan Menulis*

- Naskah Drama Dulmuluk*. publikasiilmiah.ums.ac.id, 2018.
- [23] A. Kusmana, "E-learning dalam Pembelajaran," *Lentera Pendidik. J. Ilmu Tarb. dan Kegur.*, vol. 14, no. 1, pp. 35–51, 2017.
- [24] S. Abi Yodha, Z. Abidin, and E. P. Adi, "Persepsi Mahasiswa Terhadap Pelaksanaan E-Learning Dalam Mata Kuliah Manajemen Sistem Informasi Mahasiswa Jurusan Teknologi Pendidikan Universitas Negeri Malang," *J. Kaji. Teknol. Pendidik.*, vol. 2, no. 3, pp. 181–187, 2019.
- [25] S. Sugiyono, *Metode Penelitian Kuantitatif, Kualitatif Dan R&D*. 2019.
- [26] Mohzana, M. Fahrurrozi, H. Haritani, M. Z. Majdi, and H. Murcahyanto, "A management model for character education in higher education," *Talent Dev. Excell.*, vol. 12, no. SpecialIssue3, 2020.
- [27] H. Murcahyanto, Y. Imtihan, R. R. Yuliatin, and H. S. Mahyumi, "Bentuk Dan Elemen Gerak Tari Dayang-Dayang," *Kaganga J. Pendidik. Sej. dan Ris. Sos.*, vol. 3, no. 2, pp. 9–19, 2020, doi: <https://doi.org/10.31539/kaganga.v3i2.1374>.
- [28] H. Murcahyanto, "Pertunjukan Menubuhkan Seni (Nya Indonesia) Dan Respon Penonton Dalam Perspektif Pascastrukturalisme," *J. Educ.*, vol. 11, no. 1, 2016.
- [29] H. Murcahyanto, M. Mohzana, and M. Fahrurrozi, "Dampak Media Sosial terhadap Kegiatan Kesenian Mahasiswa," *JOEAI J. Educ. Instr.*, vol. 4, no. 1, pp. 223–232, 2021.

# **Leadership and Principal Work Motivation Influence on School Operator Performance**

Mohzana, Hary Murcahyanto, Adri Efferi, Emilda Sulasmi,  
Koidah

## **Introduction**

In the era of globalization, the progress of information technology in the world is increasingly advanced and developing in all sectors of life, as well as in education. The era of the Indonesian government seeks to improve the quality of education as outlined in Law Number 20 of 2003 concerning the national education system which has a vision of realizing the education system as an institution. strong and authoritative social workers to empower all Indonesian citizens to develop into quality human beings so that they are capable and proactive in responding to the challenges of an ever-changing era.

To achieve educational goals in accordance with the mandate of the law, it is hoped that educational institutions such as schools must be led by principals who have managerial abilities. In every organization, leadership is one of the most important factors in determining where the organization will take. According to Soetopo and Soemanto in. Leadership is the ability and readiness that a person has to be able to influence, encourage, invite, guide, move and if necessary force others to accept that influence and then do something that can achieve a certain purpose or goal.

Leaders must be able to serve as role models and good examples for all stakeholders they lead. For this reason, the principal is an education manager who is able to create a cool atmosphere at work and can influence existing stakeholders to be more enthusiastic in doing the tasks given. So that the planned program is carried out in accordance with the expected vision, mission, and goals and can compete with other schools.

Success in improving the quality of education in schools cannot be separated from the way the principal manages and utilizes supporting facilities as well as educators, educators and administrative staff in schools. The magnitude of the duties and responsibilities carried out by the school principal, it must have highly dedicated employees to be able to provide maximum results.

At the elementary and junior high school education levels through the Instruction of the Minister of National Education No. 2 of 2011 concerning Education Data Management Activities, as well as the

Secretariat of the Directorate General of Primary and Secondary Education which has a role in collecting complete, correct, up-to-date and accurate data using the Data Collection System basic data of educators (DAPODIK). In order to continue to improve the quality of dapodik. A circular letter from the Director General of Primary and Secondary Education number 0993/D/PR/2019 has been issued regarding the quality of primary and secondary school data.

The Dapodikdasmen application data is used as a data reference in Kemendikbud programs at the basic education level. If schools do not actively participate, schools will lose because their data will not reach the Ministry of Education and Culture. The school will automatically not be touched by the programs of the Ministry of Education and Culture. Data from the Dapodikdasmen Application will be used as a data reference in the Ministry of Education and Culture programs at the basic education level such as: the provision of National Student Identification Numbers (NISN), School Operational Assistance (BOS), Poor Student Assistance (BSM), teacher allowances, National Examinations, and other programs. Therefore, schools must actively participate in data collection activities for Dapodikdasmen.

In assisting school principals in the field of administration, schools are given the authority to appoint and appoint administrative staff or school operators. Operators who are appointed to assist schools in inputting basic data for educators must have the ability and expertise in the field of computers. In addition, operators who are highly dedicated are needed to work in dealing with basic data problems for educators in schools. The main data collection for educators (DAPODIK) is carried out by the government on a national scale, in which the data management is carried out online.

With the online school data collection system through Dapodik, school operators have a very important role in entering school profile data such as school principals, educators, educators, students and school facilities such as facilities and infrastructure in the school. Primary data of school educators is very important as the main basis for the government in making decisions and policies. For this reason, the human resources who are appointed or appointed as operators are not only skilled and skilled at work but have the enthusiasm and persistence to carry out the tasks assigned to them.

The delivery of basic data updates for educators (Dapodik) carried out by school operators has a time limit that has been determined by the government. So the school operator before sending must coordinate with the principal. So that in sending data all

components in the school can be caught in accordance with the real conditions of the school. If the time limit determined by the government, the operator has not sent an update on the basic data of educators (Dapodik), it will have an impact on employee allowances and school BOS funds.

To achieve optimal results, school operators must send basic data for educators before the time limit determined by the government. In the 2020/2021 school year the progress of sending dapodik at the elementary school level throughout East Lombok Regency has been very good, this can be seen from 755 schools in East Lombok Regency, only 750 have sent. Thus placing East Lombok Regency in 6th place with 99% delivery percentage from 10 city districts in West Nusa Tenggara Province ([dapo.kemdibud.go.id](http://dapo.kemdibud.go.id)).

The less optimal performance of the operator is due to the school's lack of attention in controlling and paying attention to the operator's performance at work. Operators who are often needed in schools in every data collection report or school administration are always late and the operator's attendance rate at school is not optimal. Performance implies the work achieved, and carrying out activities to get results. High performance will provide success and success in completing assigned responsibilities and tasks, while low performance will give dissatisfaction with the tasks and responsibilities assigned to him. Performance is the result of a person as a whole during a certain period in carrying out tasks, such as work standards, targets or targets or criteria that have been determined in advance and have been mutually agreed upon [34]. While performance according to experts such as Whitmore in [40]. Convey that performance is an act, an achievement or what someone has shown through real skills. Meanwhile, according to other experts [13] states that "Performance is the result of work in quality and quantity achieved by an employee in carrying out tasks according to the responsibilities assigned to him". What is explained in the two theories is an understanding that requires skills to achieve one's success for work. [4] write that performance is something that is achieved or demonstrated achievement or work ability. In other words, performance can be interpreted as work performance. Next Armstrong and Baron [1] argues that performance is about doing work and the results achieved from that work.

To improve this performance, there must be work motivation from the operator to carry out his duties so that he is more active and enthusiastic in doing all the tasks assigned to him so as to improve his

performance. So that work motivation is very important in growing enthusiasm and enthusiasm at work. The performance of the operator is very influential on the leadership of the principal because the principal is very responsible for everything that is done by the operator in carrying out the tasks assigned to him. From the delivery of Dapodik, PMP data (Education Quality mapping) and reporting of Boss funds both online and offline. The principal's leadership on the performance of school operators is influenced by good work motivation from within the school operator. The school also provides a good policy on the performance of operators, namely in providing additional salaries or bonuses, this also gives the school operator morale in improving their performance in completing the tasks and responsibilities assigned to them.

Based on the description of the background above, it can be identified several problems in this study as follows: Operator motivation is still low, operator performance is not optimal, delays in data collection and school administration, lack of communication between operators and school principals, sub-district ranking is still in second place from 21 sub-districts, there is a lack of discipline in elementary school operators in Sambelia District, supervision has not been maximally carried out by school principals, less thorough in inputting and sending data to the dapodik server. In accordance with the problems as stated above, in general this study aims: To analyze whether leadership has an effect on the performance of elementary school operators; Analyzing work motivation can affect the performance of elementary school operators; and Analyzing that the principal's leadership has an effect on the work motivation of school operators.

To support the problems in the discussion, researchers look for various previous studies that are relevant to the problem that is the object of this current research. Therefore, to fulfill the code of ethics in scientific research, it is necessary to explore relevant previous studies. Based on the results of the exploration of previous studies that are relevant to the current research, there are several previous studies that are relevant to the current research, including:

1. Bernadetha Rizki Kaize's research in 2018 students of the Primary School Masters study program, Postgraduate Program at the Jakarta Open University with the title "Transferring Principal Leadership and Work Motivation on the Performance of Elementary School Operators in Bogor Regency".

2. Angga Debby Frayudatahun (2016) Research, Conducted research on “The Influence of Head of Service Leadership and Compensation Through Work Motivation on the Performance of Rembang Regency Education Office Employees”

A research was conducted by Lumban raja in 2014 with the title The influence of leadership style and work motivation on teacher performance at SMP Negeri 1 pandanus. Based on the description of the theoretical basis and framework of thought above, the hypotheses in this study are:

1. There is an influence of the principal's leadership on the performance of elementary school operators
2. There is an effect of work motivation on the performance of elementary school operators
3. There is an influence of the principal's leadership on the work motivation of elementary school operators

### **Research Methods**

Research on the performance of elementary school operators was carried out in elementary schools located in Sambelia District, East Lombok Regency. This research was started from July to September 2021. This research was conducted using quantitative research with a survey method with a correlational approach, namely one of the studies that is one of the studies designed to obtain information about the relationship between different variables in one population. This research was conducted in elementary schools in Sambelia District. This study examines three variables, namely two independent variables and one dependent variable. The independent variables are the principal's leadership and work motivation, while the dependent variable is the performance of elementary school operators (Y). Quantitative approach is used to measure the independent variables and dependent variables by using numbers that are processed through statistical analysis.

Research Design with 2 Independent Variables and 1 Dependent Variable  $X_1Y$

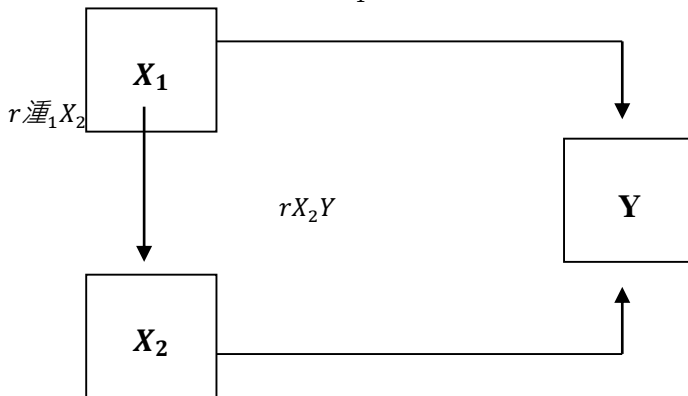


Figure 1. Research Design

Information:

$X_1$  = Principal Leadership

$X_2$  = Work motivation

$Y$  = Operator Performance

$X_1Y$  = The Influence of Principal Leadership on Operator Performance

$X_2Y$  = Operator Effect of work motivation on operator performance

$X_1X_2$  = The Influence of Principal's Leadership on Operators' Work Motivation

The data needed in this study is information related to the principal's leadership, work motivation to the performance of elementary school operators. The population in this study were all elementary school principals and elementary school operators in Sambelia District with a total population of 26 principals and 26 school operators so that the population was 52 people. The population is the entire subject to be studied with characteristics that can be said to be the same so that the results of research conducted on the population can be generalized.

Sampling was carried out by the census method, this was seen from the number of areas and objects studied so that researchers felt the need to conduct a thorough research without having to take a sample with a certain number of Sambelia District has 26 elementary schools, then the entire population will be taken as a sample, namely



the principal 26 schools and 26 elementary school operators with a total population of 52 people.

The research instrument was used to measure the value of the variables studied. The number of instruments studied depends on the number of variables studied, because the research instruments will be used for measurement with the aim of obtaining accurate quantitative data. [29]. The research data uses a score for each variable obtained through the distribution of questionnaires as a data collection instrument. The questionnaire instrument was used to collect data on the performance of school operators (Y), principals' leadership and work motivation).

In this study using the correlation method, correlation is a term used to measure the strength of the relationship between variables. Correlation analysis is a way to find out whether or not there is a relationship between variables, for example the relationship between two variables [22]. Some characteristics of a good instrument are valid and reliable. Valid means that an instrument can be said to be valid if it really measures what it wants to measure accurately. Reliable, meaning that an instrument can be said to be reliable or reliable if it has consistent results. [2]. The instrument test in this study used validity and reliability tests.

The reliability test in this study used the help of the SPSS Statistics 18.00 program to simplify calculations. If it is equal to or greater than 0.600 then the instrument is reliable, otherwise if it is less than 0.600 then the instrument is not reliable.

Data collection techniques were carried out using quantitative methods through a correlational design between the influence of school principal leadership and work motivation on the performance of elementary school operators in Sambelia sub-district using a questionnaire (questionnaire). Questionnaire (questionnaire) is a list of questions given to respondents to explore data according to research problems

The data analysis technique used in this research is statistical analysis. This analysis was conducted to see the influence of the principal's leadership and work motivation on the performance of elementary school operators, using research steps with descriptive and inferential data analysis/hypothesis testing.

Descriptive analysis is used to see the tendency of the distribution of variables and determine the level of achievement of respondents in each variable. The general description in each variable is described in the average score obtained. Descriptive analysis in this

study consisted of: a) Analysis of portrait data (frequency and percentage), b) analysis of the central tendency of the data (mean value of median and mode) and c) analysis of variation in values (range and standard deviation or variance). While the hypothesis test is done by using simple regression analysis and multiple regression analysis. Simple regression analysis was used to determine the effect of the first independent variable (X1) or the second independent variable (X2) on the dependent variable (Y). Multiple regression analysis was used to determine the effect of the first and second independent variables together on the dependent variable.

## **Results and Discussion**

### **Analysis Prerequisite Test Results**

#### **Normality test**

The normality test is used to test whether in the regression model, the confounding or residual variables have a normal distribution. The normality test of the data used in this study is the Lilifors test. Based on the test results on each variable as follows:

1. Based on the results of the normality calculation on the principal's leadership data as the dependent variable (X1) using the 2013 Microsoft Excel program, it can be taken the largest absolute value value, namely 0.137. By knowing that the critical value of L for the sample ( $n$ ) = 26 and  $\alpha = 0.05$  is 0.173, it can be concluded that the value of  $L_o$  (0.137) <  $L_\alpha$  (0.173). This means that the hypothesis is accepted or in other words the data is normally distributed.
2. Based on the results of normality calculations on work motivation data as the dependent variable (X2) using the 2013 Microsoft Excel program, it can be taken the largest absolute value value, namely 0.072. By knowing the critical value of L for the sample ( $n$ ) = 26 and  $\alpha = 0.05$  is 0.173, it can be concluded that the value of  $L_o$  (0.072) <  $L$  (0.173). This means that the hypothesis is accepted or in other words the data is normally distributed.
3. Based on the results of the normality calculation on the school operator's performance data as an independent variable (Y) using the 2013 Microsoft Excel program, it can be concluded that the largest absolute value value is 0.137. By knowing the critical value of L for the sample ( $n$ ) = 26 and  $\alpha = 0.05$  is 0.173, it can be concluded that the value of  $L_o$  (0.137) <  $L$  (0.173). This means that the hypothesis is accepted or in other words the data is normally distributed.

### Linearity Test

The linearity test was carried out with the aim of seeing the linear relationship between the dependent variable and the independent variable using the SPSS 20.0 program with the following outputs.

**Table 1. Output ANOVA Linearity Test**

ANOVA Table

			Sum of Squares	df	Mean Square	F	Sig.
Unstandardized Residual *Unstandardized Predicted Value	Between Groups	(Combined)	13,197	23	,574	2,295	,348
		Linearity	,000	1	,000	,000	1,000
		Deviation from Linearity	13,197	22	,600	2,399	,336
	Within Groups		,500	2	,250		
Total			13,697	25			

Based on the output table above, it shows that the value of Sig. The linearity of 1,000 is greater than the significance level of 0.05, thus it can be concluded that there is a linear relationship between the principal's leadership variable (X1) and the work motivation variable (X2) on the school operator's performance variable (Y).

### Hypothesis Test Results

The results of the analysis of the influence of the principal's leadership (X1) on the performance of school operators (Y)

The results of the first hypothesis test analysis output using SPSS 20.0 are shown in the table as follows.

**Table 2. Output Variable Entered**

#### Variables Entered/Removed<sup>a</sup>

Model	Variables Entered	Variables Removed	Method
1	Kepemimpinan kepala sekolah <sup>b</sup>		Enter

a. Dependent Variable: Kinerja Operator Sekolah

b. All requested variables entered.

The table above describes the variables entered and the methods used. In this case, the variables included in this analysis are the principal's leadership as the independent variable and the school operator's performance as the dependent variable and the method used in this analysis is the enter method.

**Table 3. Output Model Summary**

**Model Summary**

Model	R	R Square	Adjusted R Square	Std. Error of the Estimate
1	,994 <sup>a</sup>	,988	,988	2,002

a. Predictors: (Constant), Kepemimpinan kepala sekolah

The table above explains the magnitude of the correlation value (R). Thus the magnitude of the correlation value (R) is obtained at 0.994 and the value of the correlation coefficient (R Square) is 0.988 which means that the magnitude of the influence of the principal's leadership on the performance of school operators is 98% and the rest is the influence of other factors.

**Tabel 4. Output ANOVA Uji Hipotesis 1**

**ANOVA<sup>a</sup>**

Model		Sum of Squares	df	Mean Square	F	Sig.
1	Regression	7968,263	1	7968,263	1987,954	,000 <sup>b</sup>
	Residual	96,199	24	4,008		
	Total	8064,462	25			

a. Dependent Variable: Kinerja Operator Sekolah

b. Predictors: (Constant), Kepemimpinan kepala sekolah

From the output it is known that the magnitude of the calculated F value = 1987.954 with a significance level of 0.000 < 0.05, thus the regression model can be used to predict the school operator's performance variables. school (X1) on the school operator's performance variable (Y).

**The results of the analysis of the effect of work motivation (X2) on the performance of school operators (Y)**

The results of the first hypothesis test analysis output using SPSS 20.0 are shown in the table as follows:

**Table 5. Output Variables Entered Work Motivation**

**Variables Entered/Removed<sup>a</sup>**

Model	Variables Entered	Variables Removed	Method
1	Motivasi Kerja <sup>b</sup>	.	Enter

a. Dependent Variable: Kinerja Operator Sekolah

b. All requested variables entered.

The table above describes the variables entered and the methods used. In this case the variables included in this analysis are work motivation as an independent variable and school operator performance as the dependent variable and the method used in this analysis is the enter method.

**Table 6. Output Model Summary of Work Motivation**

**Model Summary**

Model	R	R Square	Adjusted R Square	Std. Error of the Estimate
1	,999 <sup>a</sup>	,998	,998	,761

a. Predictors: (Constant), Motivasi Kerja

The table above explains the magnitude of the correlation value (R). Thus the magnitude of the correlation value (R) is obtained at 0.999 and the value of the correlation coefficient (R Square) is 0.998, which means that the magnitude of school work motivation on the performance of school operators is 99% and the rest is the influence of other factors.

**Table 7. Output ANOVA Work Motivation**

**ANOVA<sup>a</sup>**

Model		Sum of Squares	df	Mean Square	F	Sig.
1	Regression	8050,552	1	8050,552	13890,779	,000 <sup>b</sup>
	Residual	13,909	24	,580		
	Total	8064,462	25			

a. Dependent Variable: Kinerja Operator Sekolah

b. Predictors: (Constant), Motivasi Kerja

From the output, it is known that the calculated F value = 13,890 with a significance level of  $0.000 < 0.05$ , thus the regression model can be used to predict the school operator's performance variables. Thus, it can be concluded that there is a positive and significant influence between work motivation variables (X2 ) to the school operator's performance variable (Y).

**The results of the analysis of the influence of the principal's leadership (X1) and work motivation (X2) on the performance of school operators (Y)**

The results of the F test can be seen in the ANOVAa table below. The calculated F value is seen in the last column (sig.)

**Table 8. Output ANOVA Hypothesis 3**

**ANOVA<sup>a</sup>**

Model		Sum of Squares	df	Mean Square	F	Sig.
1	Regression	8050,765	2	4025,382	6759,528	,000 <sup>b</sup>
	Residual	13,697	23	,596		
	Total	8064,462	25			

a. Dependent Variable: Kinerja Operator Sekolah

b. Predictors: (Constant), Motivasi Kerja, Kepemimpinan Kepala Sekolah

The calculated F value (sig.) in the table above is 0.000 less than the 0.05 significance level, so it can be concluded that the estimated linear regression model is feasible to use to explain the influence of principal leadership (X1) and work motivation (X2) on school operator performance. (Y).

The t-test in multiple linear regression is intended to test whether the parameters (regression coefficients and constants) that

are thought to estimate the multiple linear regression equation/model are the right parameters or not. The exact meaning here is that the parameter is able to explain the behavior of the independent variable in influencing the dependent variable. Parameters estimated in linear regression include intercept (constant) and slope (coefficient in linear equation). In this section, the t-test is focused on the slope parameter (regression coefficient) only. So the t test in question is the regression coefficient test.

The test results can be seen in the Coefficients<sup>a</sup> table as shown in the image below:

**Table 9. Output Coefficients**

**Coefficients<sup>a</sup>**

Model		Unstandardized Coefficients		Standardized Coefficients	t	Sig.
		B	Std. Error	Beta		
1	(Constant)	-4,121	1,308		-3,151	,004
	Kepemimpinan Kepala Sekolah	-,055	,092	-,053	-,598	,004
	Motivasi Kerja	1,109	,094	1,052	11,770	,000

a. Dependent Variable: Kinerja Operator Sekolah

Prob value. t count of the independent variable of the principal's leadership is 0.004 which is smaller than 0.05 so that the independent variable of the principal's leadership has a significant effect on the dependent variable of the school operator's performance at alpha 5% or in other words, the principal's leadership has a significant effect on the performance of school operators at a confidence level of 95 %. Similarly, the effect of the independent variable on work motivation on the dependent variable on the performance of school operators, because the value of t count (0.000) is smaller than 0.05, so it can be said that the independent variable of work motivation has a significant effect on the dependent variable on the performance of school operators at alpha 5%.

## Discussion

The first step taken by researchers in the implementation of this research, namely to test the validity and reliability of the questionnaire instrument that will be used in the study. Validity and reliability tests were carried out on respondents outside the population. The questionnaire instrument that has passed the validity and reliability test, is then distributed to the actual research sample.

The results of the statistical validity and reliability test using the product moment correlation for validity testing and alpha crumback for reliability testing showed that of the 50 statement items from the three questionnaires, namely the leadership questionnaire, the principal's work motivation and the school operator's performance questionnaire, 38 items were declared valid. and the three questionnaires were declared reliable.

After the data was collected, the researcher carried out an assumption test, namely the normality test using the Lilifors test and the linearity test using correlation. The results of the normality test on each data, namely school coconut leadership data, work motivation data and school operator performance data show that the data are normally distributed and have a linear relationship between school coconut leadership and work motivation on the performance of school operators.

The next step in this research is to test the hypothesis on each hypothesis, namely:

**1. There is an influence of leadership on the performance of school operators**

The results of the hypothesis test indicate that there is a significant influence between leadership as an independent variable (X1) on the performance of school operators as the dependent variable (Y), this is evidenced by the value of the output, it is known that the calculated F value is smaller than the 5% significance level, with Thus the regression model can be used to predict the school operator's performance variable. Thus, it can be concluded that there is a positive and significant influence between the leadership variable (X1) on the school operator's performance variable (Y).

**2. There is an effect of the principal's work motivation on the performance of school operators.**

As in the first hypothesis, the second hypothesis also illustrates that the value is smaller than the significance of 5%, thus the regression model can be used to predict the school operator's performance variables, thus it can be concluded that there is a positive and significant influence between the work motivation variables (X2) on the school operator's performance variable (Y).

**3. There is an influence of the principal's leadership and work motivation on the performance of school operators**

By paying attention to the value of prob. (sig.) is smaller than the 0.05 significance level, so it can be concluded that the estimated linear regression model is feasible to use to explain the effect of



leadership (X) and work motivation (X) on the performance of school operators (Y). furthermore when viewed from the prob value. of the independent variable of leadership is less than 0.05 so that the independent variable of the principal's leadership has a significant effect on the dependent variable of the school operator's performance at alpha 5% or in other words, the principal's leadership has a significant effect on the performance of the school operator at the 95% confidence level. Likewise, the effect of the independent variable on work motivation on the dependent variable on the performance of school operators, because the value of prob. (0.000) which is smaller than 0.05 so it can be said that the independent variable of work motivation has a significant effect on the dependent variable of school operator performance at alpha 5%.

### **Conclusion**

Based on the results of research and discussion, it can be concluded that:

1. The data obtained from respondents on each variable have met the assumption test as a condition that must be met in parametric statistics. The assumption test in question is that all data obtained on each variable are normally distributed and have a linear relationship between each of these variables.
2. The results of the first hypothesis test indicate that there is a significant influence between the leadership of the principal and the performance of school operators in the Sambelia sub-district.
3. The results of the second hypothesis test show that there is a relationship between work motivation and the performance of school operators in Sambelia sub-district.
4. After seeing the results of the first and second hypotheses, hypothesis testing was carried out on the two independent variables on the dependent variable. The test results show that there is a significant influence between the principal's leadership and work motivation on the performance of school operators in the Sambelia sub-district.

### **References**

- [1] Abdullah, M. (2014). *Manajemen dan evaluasi kinerja karyawan* (p. 3). Aswaja Pressindo.
- [2] Arifin, Z. (2012). *Evaluasi pembelajaran Bandung*. Bandung: PT Remaja Rosdakarya.

- [3] Basri, H., & Tatang, S. (2015). *Kepemimpinan Pendidikan*. Bandung: Pustaka Setia.
- [4] Daryanto, A. (2011). *Kepala Sekolah sebagai Pemimpin Pembelajaran*. Yogyakarta: Gava Media.
- [5] Hadi, S. (2004). *Analisis regresi*. Penerbit Andi.
- [6] Handoko, T. H. (2003). *Manajemen edisi 2*. Yogyakarta: BPFE.
- [7] Hasibuan, M. S. P., & Hasibuan, H. M. S. P. (2016). *Manajemen sumber daya manusia*. Bumi Aksara.
- [8] Herlina, V. (2019). *Panduan praktis mengolah data kuesioner menggunakan SPSS*. Elex Media Komputindo. [https://scholar.google.co.id/scholar?hl=id&as\\_sdt=0%2C5&q=Kuesioner+angket&btnG=](https://scholar.google.co.id/scholar?hl=id&as_sdt=0%2C5&q=Kuesioner+angket&btnG=)
- [9] Husein, L. (2017). *Profesi Keguruan Menjadi Guru Profesional*. Yogyakarta: PT. Pustaka Baru Press.
- [10] Kamil, M. (2010). *Model pendidikan dan pelatihan (konsep dan aplikasi)*. Bandung: Alfabeta.
- [11] Kresitama, K. P. P. T. G. M., Medan, P. P. T. W. K., Jaya, K. K. P. A., Yang, M. B. D. Ki. G., & di Jember, S. B. (n.d.). *Jurnal PasMan*.
- [12] Malayu, H. (2008). *Organisasi dan motivasi*. Bumi Aksara, Jakarta.
- [13] Mangkunegara, A. A. A. P. (2016). *Manajemen sumber daya manusia perusahaan*. PT. Remaja Rosdakarya.
- [14] Mulyasa, E. (2009). *Praktik penelitian tindakan kelas*. Bandung: PT Remaja Rosdakarya, 84.
- [15] Purwanto, M. N. (2012). *Administrasi dan Supervisi Pendidikan Cet. 2*. Bandung: PT. Remaja Rosdakarya.
- [16] Rahadi, D. R. (2010). *Manajemen Kinerja Sumber Daya Manusia*. Malang: Tunggal Mandiri Publishing.
- [17] Rahmat, A., & Kadir, S. (2017). *Kepemimpinan Pendidikan dan Budaya Mutu*. Yogyakarta: Zahir Publishing.
- [18] Riduwan, M. B. A. (2013). *Metode & Teknik Menyusun Tesis*. Alfabeta, Bandung.
- [19] Rismawati, S. E., & Mattalata, S. E. (2018). *Evaluasi Kinerja: Penilaian Kinerja Atas Dasar Prestasi Kerja Berorientasi Kedepan (Vol. 1)*. Celebes Media Perkasa.
- [20] Robbins, S. P., Judge, T. A., & Saraswati, R. (1919). *Perilaku organisasi*. -.
- [21] Rohiat, D., & Pd, M. (2008). *Kecerdasan emosional kepemimpinan kepala sekolah*. PT Rafika Aditama, Bandung.
- [22] Sapardi, U. (n.d.). S. 2012. *Aplikasi Statistika Dalam Penelitian: Buku Tentang Statistika Yang Paling Komprehensif*.
- [23] Sardiman, A. M. (2011). *Interaksi dan Motivasi Belajar Mengajar*

- Cet. Ke-20*. Jakarta: Rajawali Pers.
- [24] Siagian, S. P. (2011). *Manajemen Sumber Daya Manusia Edisi 1 Cetakan ke 19*. Bumi Aksara, Jakarta.
- [25] Siagian, S. P. (2018). *Teori motivasi dan aplikasinya*. Rineka Cipta.
- [26] Siswanto, H. B. (2012). *Pengantar Manajemen*, Penerbit: PT. Bumi Aksara, Jakarta.
- [27] Sudarwono, L. (2014). *Teori dan Praktek kepemimpinan*. Jakarta: Lentera Ilmu Cendekia.
- [28] Sudaryono, D. (2014). *Leadership Teori dan Praktek Kepemimpinan*. Jakarta: Lentera Ilmu Cendekia.
- [29] Sugiyono, D. (2016). *Metode penelitian kuantitatif dan R&D*. Bandung: Alfabeta.
- [30] Sugiyono, S. (2012). *Metode penelitian kuantitatif dan kualitatif dan R&D*. Alfabeta Bandung.
- [31] Suharsimi, A. (2013). *Prosedur Penelitian: Suatu Pendekatan Praktik*. Jakarta: Rineka Cipta .
- [32] Suharsimi, Arikunto. (2013). *Prosedur penelitian suatu pendekatan praktik*. Jakarta: Rineka Cipta.
- [33] Suherman, A., & Saondi, O. (2010). *Etika profesi keguruan*. Bandung: PT Refika Aditama.
- [34] Suryani, N. K., & SE, M. M. (2019). *Manajemen Sumber Daya Manusia: Tinjauan Praktis Aplikatif*. Nilacakra.
- [35] Tatang, S. (2015). *Manajemen Pendidikan Berbasis Sekolah/Tatang S. CV Pustaka Setia*, 112. [https://scholar.google.com/scholar?start=20&q=buku+manajemen+pendidikan+berbasis+sekolah&hl=en&as\\_sdt=0,5](https://scholar.google.com/scholar?start=20&q=buku+manajemen+pendidikan+berbasis+sekolah&hl=en&as_sdt=0,5)
- [36] Teaching, C. E., & Environments, L. (2009). *First Results from Teaching And Learning International Survey (TALIS)[Internet]. Paris (FR); 2009 [cited 2020 Oct 20]*.
- [37] Triwanti, S. W. (2014). *Pengaruh Kepemimpinan Kepala Sekolah, Motivasi Kerja Guru, Dan Budaya Sekolah Terhadap Kinerja Guru SMP/MTS di Kecamatan Galur Kabupaten Kulon Progo. Jurnal Ilmiah Guru Caraka Olah Pikir Edukatif*, 2.
- [38] Uno, H. (2017). *B (2017). Teori Motivasi & Pengukurannya*. Jakarta: Bumi Aksara.
- [39] Uno, H. B. (2016). *Teori Motivasi & Pengukurannya. Cetakan keempat belas*. PT. Bumi Aksara. Jakarta.
- [40] Uno, H. B., & Lamatenggo, N. (2012). *Performance Theory and Measurement*. Jakarta: Earth Literacy.

# **Teacher Decision Making: Strategies to Give Examples Through Posing and Solving Mathematical Problems**

Muchtadi

## **Introduction**

The success of a teacher in managing the implementation of mathematics learning, one of which is determined by the ability to explain. In the core learning activities, for example, there is a part that needs an explanation [1], namely giving an example of the concept of the material to be discussed. In this section, the teacher has an important role and is a key factor in helping students achieve learning goals [2]. Examples created, selected, and used by teachers [3],[4], are usually positioned as embodiments of the concepts that will be given to students in the form of posing and solving the problem [5] which tend to always have a solution [6].

In mathematics learning, examples are important elements [7],[8] because they have several functions, including: (a) is a tool for developing mathematical ideas [9],[10]; (b) through examples, the teacher can access, understand the minds of students [11],[12]; (c) by making more examples, the teacher can accelerate the development of his pedagogy [13]. (d) giving examples has an impact on the quality of teachers and mathematics learning outcomes [14]. In addition, examples of mathematics posing and solving also have important positions and roles in learning [15],[16]. So that when giving and explaining it in different and new forms for students, the teacher at least requires experience first as a student and teacher [17]. Through this experience, teachers are expected to help students deeper understanding, develop self-confidence, advance problem-solving skills, develop abilities and autonomy in learning mathematics [18].

As an integral part of the instructional explanation, the ability to provide and explain examples of posing and solving a problem is not the same for every teacher. Some teachers can innovate [19], in teaching example as a process that must be passed, but some teachers consider the sample as a finished product, so there is no need to explain at the outset. Some experts claim that the teaching experience and knowledge possessed by each teacher is a factor causing these differences [20],[21]. In addition, the teacher's ability to reflect on

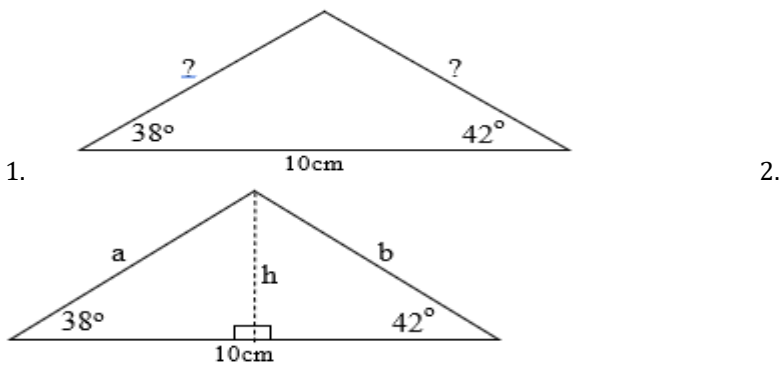
events that occur in class can help to make examples of better mathematical posing and solving problems.

For research purposes, researchers conducted a preliminary study with a focus on observing the implementation of mathematical examples by teachers in 22 public high schools in Sambas Regency, Indonesia. As a first step, the researcher was assisted by several prospective teachers spread across several schools, conducting a short interview with 65 teachers supporting mathematics subjects regarding the technical implementation of the examples when teaching in class. The results are as follows: (a) 30 subject-matter teachers carry out effective learning according to the teaching schedule. Information about giving examples is following the lesson plan, but the form is an explanation of how to solve problems until answers are found and the teacher tends to depend on the book. (b), 33 subject teachers carry out effective learning according to the teaching schedule, information on providing examples is following the lesson plan, teachers can explain examples without seeing books, even teachers can interact with students; (c) 2 teachers provide an example explanation by the plan made, starting with raising a general problem, followed by a specific problem followed by a solution, carried out repeatedly until the answer to be found. The teacher claims to carry out the explanation process until there are no questions and the students claim to have understood.

## **Discussion**

After getting permission from the teacher concerned, researchers began to make observations. First, the teacher conveys the learning objectives, followed by reminding about the Trigonometry material that has been learned. In the core activity, the teacher gives an example of raising a problem that is "is it possible to determine the sides of an unknown triangle, if it is known the length of one side and the magnitude of each of the two angles?" When citing an example of the problem-posing, the teacher while drawing a triangle then writes down the length of one side (10 cm), and the magnitude of each of the two angles specified together with the students ( $38^\circ$  and  $42^\circ$ ). While the unknown side has a question mark (?), It looks like Figure 1. The researcher observes the explanation process of the example of the problem-posing, namely (a) The teacher asks students to draw a triangle like the one on the blackboard authentically (according to size). The question arises from the teacher, "how to draw it?" Then the teacher explains how to draw the triangle

on the board (Figure 1), followed by students drawing in each book. When students draw, the teacher goes around while checking and correcting the drawings made by students. After completing a tour of the class, the teacher returns to the front of the class, draws a high line on the existing triangle, and is given the symbol has the high line, a and b represent both unknown sides, followed by explaining how to draw it (Figure 2). This followed by going back around checking and correcting the drawings made by students.



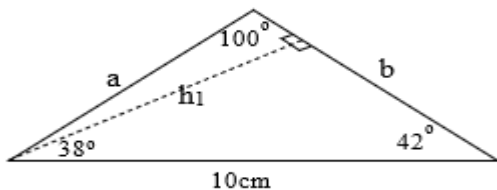
**Figure 1. Illustration of main problem-posing 2. Triangle with a high line h**

In the next process (b) the teacher asks the question "what equation can be formulated to look for unknown sides?" To formulate the equation, the teacher and students recall the Sine formula that can be used on a right triangle. The first construction uses the right half symbol of Figure 2, h, b, and  $\angle 42^\circ$ . With students, the teacher mentioned (while writing on the blackboard) that  $\frac{h}{b} = \text{Sin}42^\circ$ ; obtained  $h = b \cdot \text{Sin}42^\circ$ . The second construction uses the half part of Figure 2 to the left, namely h, a, and  $\angle 38^\circ$ . With students, the teacher mentioned (while writing on the board) that  $\frac{h}{a} = \text{Sin}38^\circ$ ; obtained  $h = a \cdot \text{Sin}38^\circ$ . The teacher and the students agreed that h in the two constructions were the same, so that obtained  $a \cdot \text{Sin}38^\circ = b \cdot \text{Sin}42^\circ$ ; equal to  $\frac{a}{\text{Sin}42^\circ} = \frac{b}{\text{Sin}38^\circ}$ . For the teacher's writing on the board, the results are like Figure 3 and are stated as the first equation. To continue the construction of the next equation, the teacher and students look for an angle facing the side with a length of 10 cm. By adding up the two known angles and subtracting from one

hundred eighty degrees, you get a hundred-degree angle ( $180^\circ - (42^\circ + 38^\circ) = 100^\circ$ ). To facilitate the use of drawings, the teacher clones the first triangle and draws a height line  $h_1$  which is located differently, which is faced by forty-two degrees and one hundred degrees (Figure 4). The third equation construction uses the symbol side  $a$ , angle of one hundred degrees ( $100^\circ$ ), and line-height  $h_1$ . With students, the teacher mentions (writing on the board),  $\frac{h_1}{a} = \text{Sin}100^\circ$ . Obtained  $h_1 = a \cdot \text{Sin}100^\circ$ . The fourth construction uses a 10 cm side symbol,  $\angle 42^\circ$  and  $h_1$  height lines.

$$\left. \begin{aligned} \text{Sin } 42^\circ &= \frac{h_1}{a} \Rightarrow b \text{ Sin } 42^\circ \\ \text{Sin } 38^\circ &= \frac{h_1}{a} \Rightarrow a \text{ Sin } 38^\circ \end{aligned} \right\} b \text{ Sin } 42^\circ = a \text{ Sin } 38^\circ; \frac{a}{\text{Sin } 42^\circ} = \frac{b}{\text{Sin } 38^\circ}$$

**Figure 3. First equation construction**



**Figure 4 Triangles with Symbols a, b, 10cm,  $h_1$ ,  $\angle 100^\circ$ ,  $\angle 38^\circ$  and  $\angle 42^\circ$**

With students, the teacher mentions (while writing on the blackboard) that  $\frac{h_1}{10} = \text{Sin}42^\circ$ ; obtained  $h_1 = 10 \cdot \text{Sin}42^\circ$ . The teacher and the students agree that  $h_1$  in the third and fourth constructions are the same so that the teacher and the students agree that  $h_1$  in the third and fourth constructions are the same, so that  $\frac{a}{\text{Sin}42^\circ} = \frac{10}{\text{Sin}100^\circ}$  is obtained. For the teacher's writing on the board, the results are like Figure 5 and expressed as the second equation.

$$\left. \begin{aligned} \text{Sin } 100^\circ &= \frac{h_1}{a} \Rightarrow h_1 = a \text{ Sin } 100^\circ \\ \text{Sin } 42^\circ &= \frac{h_1}{10} \Rightarrow h_1 = a \text{ Sin } 42^\circ \end{aligned} \right\} a \text{ Sin } 100^\circ = a \text{ Sin } 42^\circ; \frac{a}{\text{Sin } 42^\circ} = \frac{10}{\text{Sin } 100^\circ}$$

**Figure 5. The second equation construction**

Based on the construction of the first and second equations, the teacher and the students get one part that exists in both, namely  $\frac{a}{\text{Sin}42^\circ}$ . For this reason, the teacher and students conclude that

$\frac{a}{\sin 42^\circ} = \frac{b}{\sin 38^\circ} = \frac{10}{\sin 100^\circ}$ . They call it the Sine Rule equation (Figure 6). The teacher and students also ensure that the conditions for the occurrence of the Sinus rules are (a) side a with an angle of forty-two degrees ( $42^\circ$ ) so that  $\frac{a}{\sin 42^\circ}$  occurs; (b) side b faces an angle of thirty-eight degrees ( $38^\circ$ ) so that it occurs  $\frac{b}{\sin 38^\circ}$ ; (c) ten to one hundred-degree ( $100^\circ$ ) angles so that  $\frac{10}{\sin 100^\circ}$ .

$$\frac{a}{\sin 42^\circ} = \frac{b}{\sin 38^\circ} = \frac{10 \text{ cm}}{\sin 100^\circ}$$

### Figure 6 Sine rule construction

In the next process (c), the teacher asks the question "How to use the rules of equality that have been found to determine the two sides that are not yet known?". For this reason, the teacher and the students agree to use the part that has a value that is  $\frac{10}{\sin 100^\circ}$  against the part to be searched for. First, use  $\frac{a}{\sin 42^\circ} = \frac{10}{\sin 100^\circ}$ . So that  $a = 10 \cdot \frac{\sin 42^\circ}{\sin 100^\circ}$ . With the help of a sine value table that has been distributed to all students and knowledge of peer angles, a value is obtained (Figure 7). Next using the next equation and in the same way, b value (Figure 8) is obtained  $\frac{b}{\sin 38^\circ} = \frac{10}{\sin 100^\circ}$ ;  $b = 10 \cdot \frac{\sin 38^\circ}{\sin 100^\circ}$ . After obtaining the grades a and b, the teacher asks students to check the answers obtained using the formula, by measuring the picture made by each student. It turns out the results are the same and based on this the teacher confirms that the measurement and use of the formula carried out correctly the results will be the same.

$$\frac{a}{\sin 42^\circ} = \frac{10}{\sin 100^\circ}; a = \frac{10 \sin 42^\circ}{\sin 100^\circ} = \frac{10 \cdot 0,67}{0,98} = \frac{6,7}{0,98} = 6,85$$

### Figure 7 Step to find a value

Then the process (d) the teacher and students work on additional examples of problem posing. The teacher draws an arbitrary triangle complete with known symbols and questioned sides. After that, discussing with students, using the understanding that has been previously learned about the rules of using equations to obtain the results of the problem being asked After it was agreed that



the discussion was sufficient, the material continued with another concept.

$$\frac{b}{\sin 38^\circ} = \frac{10}{\sin 100^\circ}; b = \frac{10 \sin 38^\circ}{\sin 100^\circ} = \frac{10 \cdot 0,62}{0,98} = \frac{6,2}{0,98} = 6,34$$

**Figure 8 Step to find b value**

After the teacher finishes learning and has left the classroom, the researcher gives an interview with the teacher regarding the steps to explain the example to students. The transcript of the conversation between the researcher (R) and the teacher (T) is as follows.

Based on the researchers' interview with the teacher, the teacher's answers clearly illustrate the summary that is done when carrying out learning in the classroom. The researcher describes the submission of common problems made by the teacher [22] by mentioning the sentence "how to determine the length of two unknown sides if one side and the angle of a triangle are known?" To solve the problem-posing, the teacher gives several new problem-posing [23]. First, the teacher decides to draw by mentioning the phrase "how to draw the triangle?" Followed by explaining how to draw to students. Then examine the pictures made in the student book one by one to finish. The correct picture is given appreciation with the sentence "Good, the picture is correct", which has not been taught to the point and says "how can that be?". Through these actions, it seems that the teacher wants to ensure and motivate students to be able to draw triangle objects properly and correctly. According to the teacher, explaining how to draw, examine results, ascertain and motivate students is a problem-solving activity [24].

**Table 1. Teacher strategies provide examples**

Strategy	Problem Posing	Problem Solving
State the Learning Objectives	How do you determine the sides of a triangle, if you know one side and the size of the angle? "	Prepare sub-problem posing of the next.
Drawing Objects	How do you draw the triangle object?	Draw while explaining how to refer to the submission of common problems.
Construct the Equations	What equation can be formulated to find the unknown side?	Apply the Sine formula to a right triangle based on the triangle image on the board.
Using Equations	How to use the equation rules that have been found?	Agree to use the Sine rules that already have values to find other values.
Checking Results	Is what was done right?	Examining, starting from the stage of drawing objects, constructing and using equations.
Understanding Anchoring	Do you understand?	Agree to make a statement that everyone understands, about the concept.

Second, the teacher proposes the next problem to continue the explanation of the completion of the example [25], "how to construct equations based on the picture we made to determine the

length of both sides?" The solution is done using parts of the triangle so that the Sine rule equation is obtained. In this section the teacher carries out the act of checking, stabilizing, and motivating students. Third, the teacher poses the next problem "how to use the equation that has been found? Using the data in the triangles, the teacher and students apply the rules of the equation, starting with the part that has value. With the help of Trigonometry value tables and counting steps, the value in question can be found. Fourth, the teacher poses a problem that is "Is what was found correct?" With students, the teacher conducts an examination, starting from the process of drawing, constructing equations, using equations. Fifth, the teacher poses a problem that is, "Do you understand everything?" The teacher always provides confirmation and re-explanation starting from drawing objects, constructing equations, using equation rules, and finally adding examples of problems to be worked on together.

### **Conclusion**

The use of posing and solving problems when the teacher provides an example explanation with certain concepts in the learning process is very important. Posing and solving problems helps the teacher to apply all his resources (ie knowledge and everything he can use), plan, implement and ensure the achievement of objectives, and ensure the learning orientation is met. Besides that, he can also help teachers to make decisions in implementing the strategy steps to explain examples to students. Gaining experience applying the application and resolution of problems when becoming a student, a teacher must use examples when learning. Through the submission and problem solving, the teacher provides for students to explore the examples provided until they truly understand and understand.

The topic of giving and explaining examples through posing and solving problems still needs to be studied in more depth. As further research, it can be investigated how teacher decision making, the components of decision making by teachers, of course, are still related to examples of posing and solving mathematical problems.

### **References**

- [1] G. Leinhardt, "Introduction: Explaining Instructional Explanations," in *Instructional Explanations in the Disciplines*, M. K. Stein and L. Kucan, Eds. Boston, MA: Springer US, 2010, pp. 1–5. doi: 10.1007/978-1-4419-0594-9\_1.

- [2] J. Eggleston, "Making decisions in the classroom," *Camb. J. Educ.*, vol. 7, no. 1, pp. 5–11, Feb. 2006, doi: 10.1080/0305764770070102.
- [3] H. Borko, S. A. Roberts, and R. Shavelson, "Teachers' Decision Making: from Alan J. Bishop to Today," in *Critical Issues in Mathematics Education: Major Contributions of Alan Bishop*, P. Clarkson and N. Presmeg, Eds. Boston, MA: Springer US, 2008, pp. 37–67. doi: 10.1007/978-0-387-09673-5\_4.
- [4] I. Zodik and O. Zaslavsky, "Characteristics of teachers' choice of examples in and for the mathematics classroom," *Educ. Stud. Math.*, vol. 69, no. 2, pp. 165–182, Oct. 2008, doi: 10.1007/s10649-008-9140-6.
- [5] K. Kojima, K. Miwa, and T. Matsui, "Experimental study of learning support through examples in mathematical problem posing," *Res. Pract. Technol. Enhanc. Learn.*, vol. 10, no. 1, p. 1, 2015, doi: 10.1007/s41039-015-0001-5.
- [6] C. Olteanu, "Reflection-for-action and the choice or design of examples in the teaching of mathematics," *Math. Educ. Res. J.*, vol. 29, no. 3, pp. 349–367, Sep. 2017, doi: 10.1007/s13394-017-0211-9.
- [7] O. Zaslavsky, "The Explanatory Power of Examples in Mathematics: Challenges for Teaching," in *Instructional Explanations in the Disciplines*, M. K. Stein and L. Kucan, Eds. Boston, MA: Springer US, 2010, pp. 107–128. doi: 10.1007/978-1-4419-0594-9\_8.
- [8] R. Zazkis and R. Leikin, "Exemplifying definitions: a case of a square," *Educ. Stud. Math.*, vol. 69, no. 2, pp. 131–148, Oct. 2008, doi: 10.1007/s10649-008-9131-7.
- [9] A. G. Lynch and E. Lockwood, "A comparison between mathematicians' and students' use of examples for conjecturing and proving," *J. Math. Behav.*, Aug. 2017, doi: 10.1016/j.jmathb.2017.07.004.
- [10] P. Goldenberg and J. Mason, "Shedding light on and with example spaces," *Educ. Stud. Math.*, vol. 69, no. 2, pp. 183–194, Oct. 2008, doi: 10.1007/s10649-008-9143-3.
- [11] Deborah. L. Ball and F. M. Forzani, "The Work of Teaching and the Challenge for Teacher Education," *J. Teach. Educ.*, vol. 60, no. 5, pp. 497–511, Nov. 2009, doi: 10.1177/0022487109348479.
- [12] H. P. Osana and I. Pelczer, "A Review on Problem Posing in Teacher Education," in *Mathematical Problem Posing: From Research to Effective Practice*, F. M. Singer, N. F. Ellerton, and J.

- Cai, Eds. New York, NY: Springer New York, 2015, pp. 469–492. doi: 10.1007/978-1-4614-6258-3\_23.
- [13] M. Ticha and A. Hospesova, “Problem posing and development of pedagogical content knowledge in pre-service teacher training,” in *Proceedings of the Sixth Congress of the European Society for Research in Mathematics Education*, Lyon, France, 2010, vol. 6, pp. 1941–1950.
- [14] O. Zaslavsky, “Mathematics-related tasks, teacher education, and teacher educators,” *J. Math. Teach. Educ.*, vol. 10, no. 4, pp. 433–440, Dec. 2007, doi: 10.1007/s10857-007-9060-x.
- [15] N. F. Ellerton, “Engaging pre-service middle-school teacher-education students in mathematical problem posing: development of an active learning framework,” *Educ. Stud. Math.*, vol. 83, no. 1, pp. 87–101, May 2013, doi: 10.1007/s10649-012-9449-z.
- [16] E. A. Silver, “Problem-posing research in mathematics education: looking back, looking around, and looking ahead,” *Educ. Stud. Math.*, vol. 83, no. 1, pp. 157–162, May 2013, doi: 10.1007/s10649-013-9477-3.
- [17] F. M. Singer, N. Ellerton, and J. Cai, “Problem-posing research in mathematics education: new questions and directions,” *Educ. Stud. Math.*, vol. 83, no. 1, pp. 1–7, 2013, doi: 10.1007/s10649-013-9478-2.
- [18] A. Leavy and M. Hourigan, “Posing mathematically worthwhile problems: developing the problem-posing skills of prospective teachers,” *J. Math. Teach. Educ.*, Jan. 2019, doi: 10.1007/s10857-018-09425-w.
- [19] I. Kontorovich and B. Koichu, “Feeling of Innovation in Expert Problem Posing,” *Nord. Stud. Math. Educ.*, vol. 17, no. 3–4, pp. 199–212, 2012.
- [20] D. L. Ball, M. H. Thames, and G. Phelps, “Content Knowledge for Teaching: What Makes It Special?” *J. Teach. Educ.*, vol. 59, no. 5, pp. 389–407, 2008, doi: 10.1177/0022487108324554.
- [21] T. Rowland, P. Huckstep, and A. Thwaites, “Elementary Teachers’ Mathematics Subject Knowledge: The Knowledge Quartet and the Case of Naomi,” *J. Math. Teach. Educ.*, vol. 8, no. 3, pp. 255–281, Jun. 2005, doi: 10.1007/s10857-005-0853-5.
- [22] F. M. Singer and C. Voica, “A problem-solving conceptual framework and its implications in designing problem-posing tasks,” *Educ. Stud. Math.*, vol. 83, no. 1, pp. 9–26, May 2013, doi: 10.1007/s10649-012-9422-x.

- [23] C. Bonotto, "Artifacts as sources for problem-posing activities," *Educ. Stud. Math.*, vol. 83, no. 1, pp. 37–55, 2013, doi: 10.1007/s10649-012-9441-7.
- [24] K.-E. Chang, L.-J. Wu, S.-E. Weng, and Y.-T. Sung, "Embedding game-based problem-solving phase into problem-posing system for mathematics learning," *Comput. Educ.*, vol. 58, no. 2, pp. 775–786, Feb. 2012, doi: 10.1016/j.compedu.2011.10.002.
- [25] X. Y. Van Harpen and B. Sriraman, "Creativity and mathematical problem posing: an analysis of high school students' mathematical problem posing in China and the USA," *Educ. Stud. Math.*, vol. 82, no. 2, pp. 201–221, Feb. 2013, doi: 10.1007/s10649-012-9419-5.

# Sharia Marketing Era of Industrial Revolution 4.0 in Improving Customer Loyalty

Muh. Fahrurrozi<sup>77</sup>, Heru Cahyono<sup>78</sup>, Nursaid<sup>79</sup>

## Introduction

The world is entering the era of the industrial revolution 4.0 or the fourth world industrial revolution where technology has become the basis of human life. Everything becomes limitless and unlimited due to the development of the internet and digital technology. This era has influenced many aspects of life both in the fields of economy, politics, culture, art, and even to the world of education. The technological revolution has had a tremendous impact on human life. It has fundamentally changed the value system, way of thinking, insight and changed human relations with the environment, both with the natural surroundings and with each other. These changes are happening so rapidly that the entire accumulative human experience seems powerless to control the explosion of technology and the significant changes it brings.[1], [2]

The rapid development of technology causes the international community to tend to develop increasingly complex and complicated. Change after change is also growing rapidly and reaches society broadly and deeply. Such conditions make a change in the power of the customer so that the market changes. These key forces have created new behaviors for customers and challenges in marketing[3].

The Industrial Revolution was a period of massive industrialization that took place during the late 1700s to early 1800s. It started in the United Kingdom and then quickly spread around the world. The American Industrial Revolution, commonly known as the second industrial revolution, began between 1820-1870. This period included the mechanics of agriculture and textile manufacturing as well as revolutions in control, including steamships and railroads, which had social, cultural and economic impacts.[4].

Technology that is growing rapidly has an impact on supporting the activities of its users and completing the activities

---

<sup>77</sup> Universitas Hamzanwadi Lombok Timur

<sup>78</sup> Institut Agama Islam Bunga Bangsa Cirebon

<sup>79</sup> Universitas Muhammadiyah Jember

carried out. The internet is one of the developments in information technology. The internet is also getting closer to life, even most people rely heavily on the internet to carry out daily activities such as completing office or college assignments, shopping online, and social networking. The internet can be accessed easily using a cellphone or mobile phone. The development of mobile applications is also very rapid, no wonder the internet is accessed by more people via mobile than using a computer because it can be accessed anywhere and anytime. This is also supported by the emergence of several mobile phones with internet facilities that are widely available in the market. One of the mobile phones that is currently growing rapidly is Android-based smartphones.[5].

In line with the development of the internet, a new understanding of the marketing paradigm emerged in the form of a modern market/consumer-oriented marketing concept or a marketing revolution in the form of an electronic marketplace. In the business context, internet marketing has a transformational impact that creates a new paradigm in business, in the form of digital marketing. Marketing is the process of compiling an integrated communication that aims to provide information about goods or services in relation to satisfying human needs and wants.[6].

The role of marketing today is not only to deliver products or services to the hands of consumers but also how these products or services can provide satisfaction to customers while still making a profit. The goal of marketing is to attract new customers by promising added value, to set product prices attractively, to distribute products more easily, to promote effectively, and to retain existing customers while still adhering to the principle of customer satisfaction. Therefore, Allah SWT, reminds us through His words in the Qur'an Surah An Nisaa ': 29

يَا أَيُّهَا الَّذِينَ آمَنُوا لَا تَأْكُلُوا أَمْوَالَكُمْ بَيْنَكُمْ بِالْبَاطِلِ إِلَّا أَنْ تَكُونَ تِجَارَةً عَنْ تَرَاضٍ مِنْكُمْ وَلَا تَقْتُلُوا  
أَنْفُسَكُمْ إِنَّ اللَّهَ كَانَ بِكُمْ رَحِيمًا

29. O you who believe, do not eat the property of your neighbor in a vanity (untrue) way, except in the form of commerce on the basis of mutual consent between you. Don't kill yourself. Verily Allah is Most Merciful to you.

Marketing is also defined as a strategic business discipline that leads to the process of creating, offering and changing value from one initiator to its shareholders, which in the whole process is in

accordance with Islamic contracts and muamalat (business) principles.

Marketing is the art and science of customer satisfaction. The American Marketing Association defines marketing as the activity and process of creating, communicating, delivering, and offering exchanges of value to customers, clients, partners, and society at large.

Marketing has various meanings based on audience, media, and market dynamics. That's why it's no wonder that marketers define marketing in different ways. Marketing comes from the basic word "market" where one of the general meanings is the place where the sale and purchase of goods or services takes place and the exchange of goods or services between the seller and the buyer. Marketing is the activity, set of institutions and processes for creating, communicating, delivering and exchanging offerings that have value for customers, clients, partners and society at large.[7]

Excellent entrepreneurs need good and appropriate marketing management. The application of management in the company can increase the effectiveness and efficiency of the company's or organization's resources so as to achieve maximum results. Meanwhile, the urgency of marketing in the success of a company can be better understood and appreciated when considering the activities it carries out. In essence, the marketing management process anticipates and measures the importance of the needs and wants of certain consumer groups and responds to them with a flow of goods and services that satisfy these needs.

A manager in a company is often tasked with making decisions in every change that occurs in the business world. The duties of a manager usually include the activities of analyzing, planning, implementing and controlling programs designed to establish, build, and maintain, the benefits of exchange through target markets in order to achieve organizational goals (company) in the long term. The population in Indonesia, which is predominantly Muslim, cannot be separated from economic activity every second. This is because the needs of the community that must be met, both primary, secondary, and tertiary needs. With the needs of Muslims, various types of sharia business arise. The shari'ah label is given to attract consumer sympathy for the product.

If you ask several people about the definition of marketing, the answers can vary as follows: a) Marketing is selling, b) Marketing is advertising. c) Marketing is a trading concept. d) Marketing is a



business that influences the purchase action of the products and services offered.[8], [9]

This opinion cannot be faulted, each can provide a definition according to his understanding. The definition of marketing can be different for everyone. However, it is very easy to understand that marketing is an activity of exchanging value transactions owned by each party, for example exchanging products owned by the company for money owned by customers. This shows that the customer wants something from the company, and the company wants something from the customer. So as a marketer, you need to know what customers really want and how to deliver what they want to get a return that is usually measured in money in exchange.

Buchari Alma and Donni Juni Priansa in their book entitled “Sharia Business Management: Instilling Sharia Values and Practices in Contemporary Business”, state that the marketing practices of the Prophet Muhammad SAW include the following [10]:

a. Segmentation and Targeting

Segmentation and targeting were practiced by Prophet Muhammad SAW when he traded to the State of Sham, Yemen, Bahrin. Prophet Muhammad SAW knows very well what goods are liked by the residents and absorbed by the local market. After knowing the target market (targeting), Prophet Muhammad SAW prepared the merchandise that was brought to the area. The Prophet Muhammad SAW was really professional and understood well segmentation and targeting so it was very pleasing to Khadijah, who at that time was acting as her boss. The goods traded by the Prophet Muhammad were always sold quickly, because they were in accordance with the segment and target market (targeting).

b. Positioning

Positioning means how to make the goods we produce or sell have advantages, are liked, and are attached to the hearts of customers and can be attached for a long time. Positioning relates to what is in the mind of the customer, related to perception, where the perception will stick for a long time. Positioning of Prophet Muhammad SAW which is very impressive and unforgettable by customers is the key to why Prophet Muhammad SAW became a successful businessman. He sells genuine goods that are original and in accordance with the needs and desires of customers. There has never been a fight or claim from the customer that the services and products sold by the Prophet Muhammad SAW were

disappointing. Marketing is the process of compiling an integrated communication that aims to provide information about goods or services in relation to satisfying human needs and wants. Marketing is the art and science of customer satisfaction. The American Marketing Association defines marketing as the activity and process of creating, communicating, delivering and exchanging value for customers, clients, partners, and society at large. Marketing has various meanings based on audience, media, and market dynamics. That's why it's no wonder that marketers define marketing in different ways. Marketing comes from the basic word "market" where one of the general meanings is the place where the sale and purchase of goods or services takes place and the exchange of goods or services between the seller and the buyer. Marketing is the activity, set of institutions, and processes for creating, communicating, delivering, and exchanging offerings that have value for customers, clients, partners and society at large.

c. Marketing Mix (Marketing Mix)

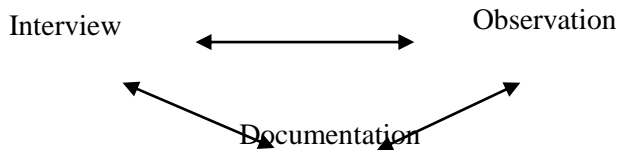
Marketing strategy to serve customers by satisfying them through product, price, place, and promotion (4P)

### **Research methods**

The type of research used is a qualitative research method. Qualitative method is a method used to examine the condition of natural objects, where the researcher is the key instrument, inductive analysis and qualitative research results emphasize meaning rather than generalization. The data collection techniques used in this study were interviews, observation, and documentation. The interviews in this study used a guided free interview technique, using a list of interviews that had been prepared in advance to be asked to informants about the company's Sharia marketing to keep pace with the industrial revolution 4.0. Observations in this study, researchers act as observers who observe directly related to the company's marketing management. In addition, documentation is used to obtain data in the form of books, archives, brochures, or documentation in the form of the Company's Sharia marketing activities. [11]

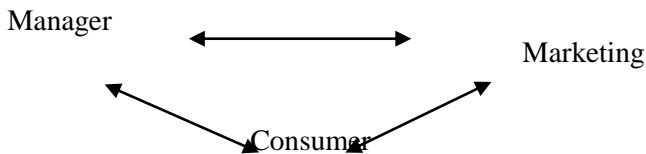
Test the validity of the data in this study using triangulation techniques and triangulation of sources. Then the results obtained from interviews need to be tested for truth with the results of observations.

1. Triangulation techniques to test the credibility of the data is done by checking the data to the same source with different techniques.



**Schematic 1 Triangulation Technique**

2. Source triangulation to test the credibility of the data is done by checking the data that has been obtained through several sources.



**Schematic 2 Source Triangulation**

3. Time triangulation is testing the validity of the data by checking with interviews, observations or other techniques at different times or situations, then it is done repeatedly so that the certainty of the data is found. This triangulation of data is useful for researchers to further improve their understanding of things and phenomena in the object of research. Valid triangulation of data will facilitate the completion of the research being done.

## **Results and Discussion**

### **Corporate Marketing in the Industrial Revolution 4.0**

Based on the results of the interview, the chairman/leader of the company said: The company's marketing is based on Islamic business. We really put forward the concept of mercy and pleasure, both from the seller and the buyer, to Allah SWT. Thus, marketing activities must be based on ethics. Marketing ethics in relation to

products, namely products that are halal and thoyyib, products that are useful and needed, products that have economic potential, products that have high added value, and products that can satisfy the community.

In addition, employees also said: The strategy implemented in our company regarding service, we always do 5 SBs: smile, greeting, greeting, polite, courteous, and helpful. On the same occasion the researcher also interviewed consumers in the company. said: What is clear is that I feel benefited by the existence of this company, so I don't bother looking for products anywhere, just order at and there is already catering too, so we don't just buy products but receive them in ripe condition, and ready distributed because it is already in a box packaging.

On the same occasion, the researcher also interviewed other consumers in the company. said: If the ones that are close are cheap, why look for those that are far away. Already know the quality of the product is good and healthy, plus the price was cheap. I also saw that many of the products were bought, and the service was also friendly. On the same occasion, the researcher also interviewed another person as a consumer in the company who said: I have always bought their products, complete, spacious, clean, close to home, friendly service, cheap prices. If the strategy is the most honest, the price is not increased according to the product, so there is no fear of being tricked by the price.

### **Corporate Sharia Marketing in the 4.0 Industrial Revolution Era**

Based on the results of the interview, the chairman/leader of the Company said: The method of marketing or dissemination or even cooler promotions that we do in this era that is completely online, of course we also take advantage of existing media such as promotions via the internet or social media, orders via whatsapp, instagram and facebook. That's how our brand can be widely known among the public.

In addition, as an employee, he also said: The marketing we do is to attract consumers' interest by distributing brochures, promotions through Facebook, Instagram and other social media. Can order via WA. Besides that, because Elsifa has many branches, our name is starting to spread everywhere.

On the same occasion, the researcher also interviewed a consumer at the company saying: Before, I never knew there was a place for this product in Cirebon, after I searched on the internet, I

found this company. From there it makes it easier for me. So I don't have to bother cooking myself. If there is something more practical, why not, it's not prohibited, instead the product is recommended by religion.

On the same occasion, the researcher also interviewed another consumer, a consumer in the company. said: The only business in Cirebon that is most well known is this company, knowing the needs of the community, especially today that public awareness has begun to grow, especially parents, to carry out their obligations.

On the same occasion the researcher also interviewed other consumers in the company saying: I am interested when the employees of the company explain about the company brochure, so we don't only buy the product but also feel the benefits, and it is ready to be distributed because it is packaged neatly. In addition, the processing method that relies heavily on Islamic law certainly adds confidence for me.

Based on the results of interviews on different occasions, the company leadership also said: The reason I developed this business was to see such a huge opportunity, especially in Cirebon, because today public awareness has grown. It is a great opportunity to become a business because the opportunity or potential for this business will never subside, especially in Indonesia, especially Cirebon, the majority is Muslim.

Based on the results of the interviews above, it can be concluded that the marketing strategy carried out by the company can adjust or can balance the industrial revolution 4.0, where everything is internet-based. Thus, the company is certain to be erasing in this era.

### **Islamic marketing advantages and constraints**

Based on the results of an interview with the chairman/leader of the Company said: The advantages that support my business are choosing a strategic marketing and livestock location, this is a very promising advantage. The prices set by the company are relatively cheap and affordable.

For small obstacles, it is relatively smooth or almost non-existent, but if there are annual obstacles, for example, the supply of products is difficult, you have to look for or wait for it to be sent from outside so that it hampers production, for marketing, thank God, there are no obstacles.

In addition, the researcher conducted interviews with employees who also said: Setting a low and right price is the leading strategy implemented in the company, the pricing strategy is very supportive of our existence until now. The main problem constraining the Company, if the weather is bad, then the supply will be delayed, for example in the rainy season, so that brochures are wet and for the delivery of orders will also be delayed.

On the same occasion, the researcher also interviewed consumers in the company who said: The company's employees always provide friendly, prompt, and smiling service. Low prices and lots of choices that many buyers are interested in. In serving too, I hardly see any complaints or irritated faces, when I am not the product.

The product stock in the company is not much so when buying the product it doesn't match my choice and if possible the stock of the product is increased so that it is right to buy the product according to my choice.

On the same occasion, the researcher also interviewed other consumers in the company who said: the company still maintains its best service, is aware that every selling activity is always under the supervision of Allah, is honest in transactions, does not lie in offering goods, does not take profits that burden buyers, and always imitates Prophetic way of business conduct.

The biggest obstacle is the stagnating supply of products from suppliers, if certain seasons. To overcome this, the owners usually take their products from other larger suppliers.

On the same occasion the researcher also interviewed other consumers in the company who said: The advantages of buying products here are complete, spacious, clean, close to home, friendly service, and low prices. If possible, there is a large size product so there are lots of choices because if it's a small one, it's a bit risky to buy it because it doesn't match your choice.

## **Conclusion**

Based on the research that has been done, it can be concluded that: 1) Company marketing in the Industrial Revolution Era 4.0 is done by using marketing or dissemination methods or even cooler promotions that we do in this era that is already completely online, of course we also take advantage of existing media, for example promotions. via the internet or social media, order via whatsapp, instagram and facebook. That's how our brand can be widely known

among the public. 2) Corporate Sharia Marketing in the Industrial Revolution Era 4.0 is based on Islamic business. We really put forward the concept of mercy and pleasure, both from the seller and the buyer, to Allah SWT. Thus, marketing activities must be based on ethics. Marketing ethics in relation to products, namely products that are halal and thoyyib, products that are useful and needed, products that have economic potential, products that have high added value, and products that can satisfy the community. 3) The advantages and constraints of Sharia Marketing in this company are always prioritizing the best service. The prices set at Elsyifa's aqiqah are relatively cheap and affordable. For small obstacles, it is relatively smooth or almost non-existent, but if there are obstacles per year, for example, there will be. supply of raw materials is difficult, you have to look for it or wait for it to be sent from outside so that it hampers production and sales.

## References

- [1] N. Kadek, D. Candra, N. K. Sinarwati, and M. Arie, "Efektivitas pengelolaan dana pada badan usaha milik desa kerta danu mandara di desa songan a," *e-Journal S1 Ak Univ. Pendidik. Ganesha*, vol. 8, no. 2, pp. 1–10, 2017.
- [2] N. F. Mukaromah and T. Wijaya, "Profit : Jurnal Kajian Ekonomi dan Perbankan," *J. Kaji. Ekon. dan Perbank.*, vol. 3, no. 1, pp. 14–29, 2019.
- [3] E. Karyani, "Transformasi Digital Dan Industri Halal : Studi Kasus Pada Produsen Besar dan UMKM," *Wikrama Parahita J. Pengabd. Masy.*, vol. 5, no. 2, 2021.
- [4] F. Budiman, "Kepuasan dan Loyalitas Nasabah Bank Syariah Indonesia Cabang Boyolali. Jurnal Ekonomi, Sosial & Humaniora," *J. Ekon. Sos. Hum.*, vol. 2, no. 5, pp. 142–166, 2020.
- [5] L. Masriansyah, "Go Digital and Customer Relationship Marketing sebagai Strategi Pemulihan Bisnis UMKM yang Efektif dan Efisien di Masa Adaptasi New Normal," pp. 126–140, 2020.
- [6] D. Rudy Irwansyah, *MARKETING DIGITAL USAHA MIKRO Tim*, vol. 1, no. 1. 2021.
- [7] D. N. Rahmatika, S. Subroto, D. Indriasih, and D. Prihadi, "Strategi Pengembangan Kualitas Bumdes; Pendekatan Model Tetrapreneur Serta Kemitraan Dengan Perguruan Tinggi Dan Perbankan," *J. Ind. Kreat. dan Kewirausahaan*, vol. 2, no. 2, pp. 84–95, 2021, doi: 10.36441/kewirausahaan.v2i2.58.
- [8] M. Mashuri, "Analisis Strategi Pemasaran UMKM Di Era 4.0,"

- IQTISHADUNA J. Ilm. Ekon. Kita*, vol. 8, no. 2, pp. 215–224, 2019, doi: 10.46367/iqtishaduna.v8i2.175.
- [9] P. K. dalam M. I. E. 4. 0. and S. 5.0., “Book Chapter 20,” no. 022, 2021.
- [10] Nurkholis, “Pendidikan dalam Upaya Memajukan Teknologi,” *J. Kependidikan*, vol. 1, no. 1, pp. 24–44, 2013.
- [11] P. D. Sugiyono, *Metode Penelitian Pendidikan; Pendekatan Kuantitatif, Kualitatif dan R&D*. 2012.



# Intelligent Transportation Management System (ITMS) in Indonesia Towards Society 5.0

Muh. Nashir T<sup>80</sup>

## Introduction

Society 5.0, in general, can be interpreted as the ability of the community to be able to solve various challenges and social problems by utilizing various creativity and innovations that were born in the era of the industrial revolution 4.0 include the internet on things (internet for everything), artificial intelligence, big data (massive data) and robots to help and improve the quality of human life. Society 5.0 can also be interpreted as a concept of society that is based on humans and based on technology. In the field of transportation, an important issue today is the intelligent transport system which is the intelligent transportation system that applies information technology, data processing, communication, and sensors to vehicles (including cars, trucks, trains, airplanes, and ships), infrastructure transportation and transportation users to improve the effectiveness, performance, environment, safety, resilience, and efficiency of transportation. Intelligent transport system (ITS) is a process of integrated communication, information, and electronics technology with transportation systems to provide innovative services to various modes of transportation and traffic management using a series of computing applications that are used to support planning, operation, and management of public transportation services.

Transportation or transport sector is a legal source to take or carry things from one place to another. With the passage of time, transportation faces many issues like high accidents rate, traffic congestion, traffic & carbon emissions air pollution, etc. In some cases, transportation sector faced alleviating the brutality of crash related injuries in accident [1].

Traffic has become an important concern in several developed and developing countries. Every country has regulations related to traffic. The density of vehicles has increased sharply every year on various roads causing congestion and accidents. Several methods have generally been used to control traffic such as installing traffic lights, traffic signs, traffic police and roundabouts, but these

---

<sup>80</sup> Civil Engineering University of Muhammadiyah Parepare

methods are being abandoned over time. In the era of technology, intelligent and adaptive devices are continuously being developed to control traffic movement.

In majority, traffic is controlled by the Intelligent Transportation System (ITS) [2]. Intelligent Transportation System is a computerized system having diverse applications connected with Vehicle Transportation, which gets the live feeds from the sophisticated sensors of the smartphone and the equipment installed on the road side or with camera mounted on the traffic light poles. Smartphones consists of high end processor and many sophisticated sensors in built. Sensors like GPS, Accelerometer, Proximity, Gyro meter, Microphone and Camera makes the smartphones different from other phones. ITS is being used and deployed in developed countries for real time navigation, traffic updates, lane discipline and predicting travel time. Its goal is to improve effectiveness, efficiency and safety of the road transportation system. ITS had been successfully deployed in various developed countries like Japan, South Korea, Singapore, United States, Australia and United Kingdom. Deployment of ITS is different in different countries, but the motive is same i.e. to improve the transportation system performance including reduced congestion, increased safety and traveler convenience [3].

## **Discussion**

### **History of ITS**

Interest in ITS begins as computer systems start becoming cheaper and smaller. In the late 1960s and early 1970s Comprehensive Automobile Traffic Control System (CACCS) was introduced in Japan and the Electronic Route Guidance System (ERGS) in the United States, and in Germany. These technologies attempted to integrate complex route guidance systems and in vehicle displays. However, technical snags and high costs prevented any of these systems from being accepted on a practical scale. Starting in the mid 1980s, ITS got a major boost when communication technologies became much cheaper and reliable and computation capabilities expanded enormously.

The motor vehicle industry detected an opportunity to add value to their products and government agencies possibilities of solving problems of congestion and safety. Large projects were launched with government-industry partnership. The European Union started Dedicated Road Infrastructure for Vehicle Safety in Europe (DRIVE), the auto manufacturers-sponsored Program for a

European Traffic System with Higher Efficiency and Unprecedented Safety (PROMETHEUS), the Japanese worked on the Road/Automobile Communication System (RACS) project, and in the U.S. the Intelligent Vehicle-Highway Systems (IVHS) project was funded. Funding for Advanced driver assistance systems (ADAS) increased during this period and aimed at providing information systems keeping the driver in full control over the vehicle and receiving supporting information from the system to an eventuality when a vehicle could be operated under fully automated control on a dedicated lane on a highway [4].

### **The Impact of Transportation**

The impact of a poor transportation system will cause various kinds of losses as follows;

1. Fuel wastage which results in public expenditure and the value of imported fuel by the government will be higher
2. Loss of time, where people will spend a lot of time traveling from origin to destination in one unit of time.
3. Economic losses, where economic losses result from all bad aspects caused by congestion.
4. The decline in environmental quality, where transportation is the second-largest contributor to emissions from the energy sector in Indonesia.
5. Traffic accidents, where 74% of traffic accidents that occur in Indonesia originate from 2 and 3 wheeled motorized vehicles.

One solution to reduce the level of congestion that exists is the application of Intelligent Transportation System (ITS) technology.

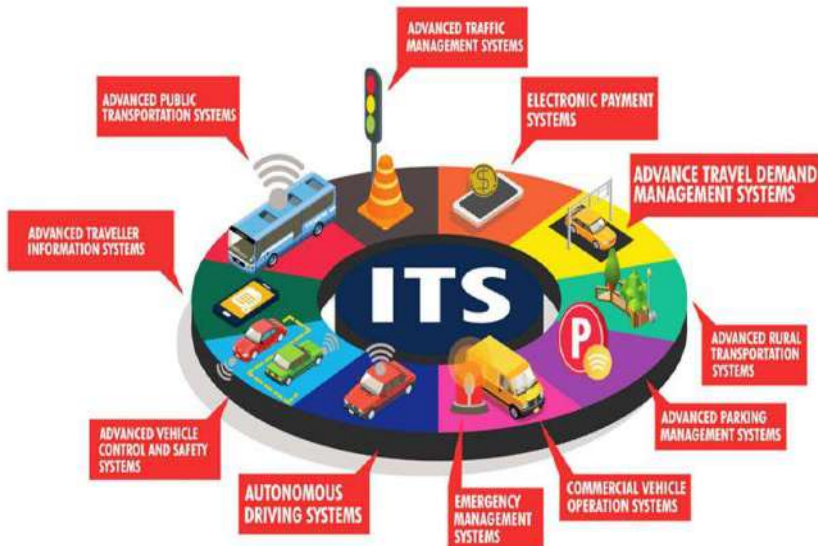
### **Intelligent Transportation Management System (ITMS) in the Field of Road Traffic and Transportation**

The intelligent transportation system is carried out using information technology applications, electronic devices, and telecommunications networks. Intelligent transportation systems are used as collectors, processing data and information. Data and information can be in the form of the following:

1. The speed of vehicles crossing a road with a specified speed limit;
2. Traffic flow patterns that show fluctuations in traffic volume over a certain period;
3. Density of number of vehicles per unit length of road, vehicles or kilometers;

4. Traffic travel time or the total time is taken to cover the distance of a journey from the origin to the destination of the trip;
5. Weather conditions that may affect traffic movements;
6. Condition of traffic and other road transportation facilities and infrastructure required.
7. Intelligent Transportation Management System aims to:
8. Supervision of traffic activities on roads and public transport services;
9. Detect and identify traffic movements on the road;
10. Vehicle communication for infrastructure using information and communication technology;
11. Collection and processing of data for planning and regulation of road transport systems;
12. Real-time road user information on traffic conditions and public transportation services.

Grand design intelligent transportation management system in Indonesia can be seen in figure:



**Figure 1 Grand Design ITMS in The Traffic and Road Transport in Indonesia [5]**

An intelligent transportation management system generally consists of:

- a. Advanced traffic management system which is a traffic management system that is used to improve vehicle traffic flow and provide real-time information for road users that is integrated with the traffic control room. The subsystems of this management system are regional traffic regulation and control, real-time traffic monitoring, electronic signage monitoring, and control, accident event monitoring, connecting road monitoring, electronic traffic law enforcement, trip time detection, and bus priority detection automatically;
- b. Advanced road user information system is a system used to provide real-time information to motorists regarding environmental conditions and road traffic conditions that affect behavior in determining routes, determining the choice of transportation modes, and optimal travel times. Subsystems can be in the form of traffic density information, alternative route information, parking information, dangerous road information, and monitoring of weather information on the road as well as radio instructions.
- c. The advanced vehicle safety and control system is a vehicle control system with the support of an intelligent system that is used to improve driving safety and stability. The subsystems, in this case, are early warning, wrong lane warning, speed warning, and violation warning.
- d. The commercial vehicle operating system is an operations management system for freight transport vehicles that are used to manage and provide services, reduce route disruptions, reduce travel delays, maintain safety levels, increase efficiency and reduce costs. The subsystem of the commercial vehicle operating system consists of vehicle classification, detection of excess dimensions and vehicle loads, and measurement of moving loads.
- e. The public transportation system is a technology-based public transportation system that is used to improve the accessibility of information, improve the safety of public transportation users, and improve the utilization and operation of public transportation facilities and traffic and road transportation infrastructure. Its subsystem consists of public transport information and public transport traffic management.
- f. Electronic payment system is an electronic payment system used for payment for transportation services with an integrated service nature and implemented under the provisions of laws and regulations regarding the electronification of transportation

payments. The subsystem consists of a front-end system in the form of channel authorization and payment instruments, a middle-end system in the form of sorting or clearing, and a back-end system in the form of a final settlement process.

- g. Emergency management system is a system used to provide information and handling in an emergency on the road. The subsystem consists of handling the information and emergency handling procedures.
- h. The advanced intercity transportation system is a system that is used to improve the efficiency of transportation management of people and goods on arterial and barrier-free roads and their connectivity with cities. The subsystems consist of tourism transportation management, people transportation management between cities, and goods transportation management.
- i. The advanced travel needs management system is a system that is used to exceed the travel needs of private vehicles by prioritizing public transport trips. The subsystem consists of restrictions on road users using vehicle identification, restrictions on road users using paid roads, and restrictions on road users using motor vehicle sign recognition.
- j. The advanced parking management system is a system that is used to make it easier for users to find a parking space, detect incidents in the parking lot, and the efficiency of the parking payment system. The subsystems are parking for vehicles on the road and off-road parking for vehicles.
- k. The autonomous control system is an integrated system that allows the control of public motorized vehicles for the safe transportation of people without drivers on predetermined travel routes. The subsystem consists of visual sensing devices, sensors, processors, and automatic driving control and safety controllers.

There are some applications associated with the use of ITS  
 There are some applications associated with the use of ITS which are as follows [3] :

**Table 1. Applications and Categories of ITS**

ITS Category	Specific Application
Advanced Traveler Information System (ATIS)	- Real-time Traffic Information - Route Guidance/Navigation Systems - Roadside Weather information System
Advanced Transportation Management Systems (ATMS)	- Traffic Operations Centers - Dynamic Traffic Signs

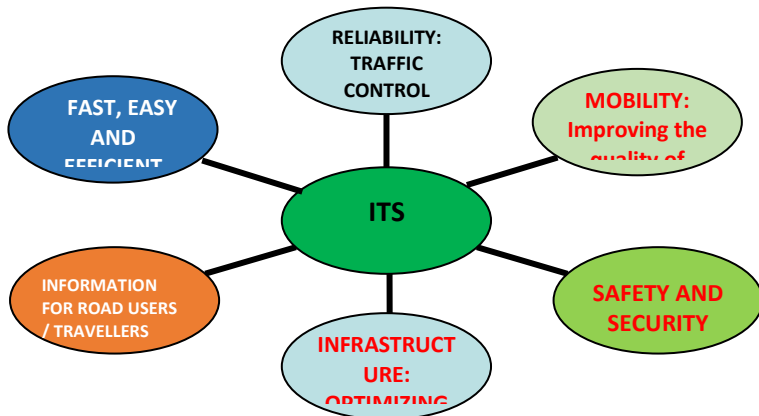
ITS-Enabled Transportation Pricing Systems (ITS- ETPS)	- Electronic Toll Collection
Advanced Public Transportation System (APTS)	- Variable Parking Fees
	- Real-time Status Information for Public Transit System
	- Automatic Vehicle Location
Fully Integrated Intelligent Transportation (FIIT)	- Collision Avoidance
Advanced Traffic Management System (ATMS)	- Intelligent Speed Adaptation
	- Real-time Traffic Status
	- Dynamic Traffic Control
	- Incidence Response
Commercial Vehicle Operations (CVO)	- Traceability and safety of commercial vehicles such as trucks, vans, and taxis.
Advanced Vehicle Control Systems (AVCS)	- Collision Warning of the vehicles
Advanced Rural Transportation System (ART)	- Provide Information about Remote Roads via Radio.

Regulation and application Intelligent Transport System (ITS) in urban transportation in Indonesia [5] :

**Table 2. Regulation and Applications ITS in Indonesia**

	REGULATION	ITS APPLICATIONS
Small City	Traffic Management	ATCS
Moderate City	1. Traffic Management 2. On-street parking arrangements	1. ATCS 2. Traffic Information (CCTC, VMS)
Large City	1. Traffic Management 2. On-street parking arrangements 3. Restriction on private vehicle (cars) (Traffic Restraint) 4. Improved Public Transport Service/Mass	1. ATCS 2. Traffic Information (CCTC, VMS) 3. E-enforcement 4. Advanced Public Transport (Operation Schedule, Seat Occupancy (drive monitoring))
Metropolitan City	1. Traffic Management 2. Arrangements and on-street parking restrictions 3. Restriction on private vehicle (cars) and Enforcement ERP 4. Improved Public Transport Service/Mass 5. Integration of Public Transport Modes	1. ATCS, Traffic Information (CCTV, VMS, Parking Information) 2. E-enforcement 3. ERP 4. Advanced Public Transport (Operation Schedule, Seat Occupancy (drive monitoring), Bus Priority) 5. Smart Card (Electronic Payment System)

The focus of relevant ITS development in Indonesia can be seen in Figure 1.



**Figure 2 ITS Development in Indonesia**

### **Conclusion**

Deployment of ITS is different in different countries, but the motive is same i.e. to improve the transportation system performance including reduced congestion, increased safety and traveler convenience. Solution to reduce the level of congestion that exists is the application of Intelligent Transportation System (ITS) technology. In the era of technology, intelligent and adaptive equipment is continuously developed to control traffic movement.

The intelligent transportation system is carried out using information technology applications, electronic devices and telecommunications networks. Intelligent transportation systems are used as data processing and information collectors. ITS Development in Indonesia is reliability, mobility, infrastructure, safety and security, information road for user/travellers and fast, easy and efficient information.

### **References**

- [1] K. N. Qureshi and A. H. Abdullah, "A survey on intelligent transportation systems," *Middle East J. Sci. Res.*, vol. 15, no. 5, pp. 629–642, 2013, doi: 10.5829/idosi.mejsr.2013.15.5.11215.
- [2] R. Sen, V. Sevani, P. Sharma, Z. Koradia, and B. Raman, "Challenges In Communication Assisted Road Transportation Systems for Developing Regions," *3rd ACM Work. Networked Syst. Dev. Reg. (NSDR'09), a Work. SOSP'09, Big Sky, Mont. USA, 11 Oct 2009.*, 2009.
- [3] G. Singh, D. Bansal, and S. Sofat, "Intelligent Transportation



- System for Developing Countries A Survey,” *Int. J. Comput. Appl.*, vol. 85, no. 3, pp. 34–38, 2014, doi: 10.5120/14824-3058.
- [4] D. Mohan, “Intelligent Transportation Systems ( ITS ) and the Transportation system,” *Transp. Res. Inj. Prev. Program. Indian Inst. Technol. Delhi, India*, no. March 2015, pp. 1–15, 2015.
- [5] A. Yani, D. A. Jalan, K. Dan, S. Pembangunan, K. Berkelanjutan, and K. Masyarakat, “PENGEMBANGAN INTELLIGENT TRANSPORT SYSTEM ( ITS ) DI INDONESIA,” no. September, pp. 1–31, 2021.
- [6] “PM No. 76 Tahun 2021 Sistem Manajemen Transportasi Cerdas di Bid. LLAJ.pdf.” .

## **Family Education during the Covid-19 Pandemic: Efforts to Build Parent-Child Attachment**

Muhammad Abrar Parinduri<sup>81</sup>

### **Introduction**

The COVID-19 pandemic outbreak has not only part of the problems of the Indonesian nation but also has become part of the world's problems. This virus has spread to almost all countries cum until today has not found the proper antidote to overcome it. In the end, this pandemic will be the biggest enemy for all people in the world, but it is an enemy that could not observe. Impacts from the virus include the fade of social relationships and change into a social relationship by social media. The challenge in family lives being more complex. In the economic sector, the families also got shocked, especially for informal workers like daily workers. The most effective stance used for financial management for those who got the direct impacts are robbing Peter to pay Paul.[1]

In response to this desperate disaster, the Minister of Education and Culture of the Republic of Indonesia Nadiem Anwar Makarim issued Circular Letter Number 4 of 2020 concerning the Implementation of Educational Policies in the Emergency Period Spread of Corona Virus Disease (Covid-19). There are at least six significant points contained in the circular letter in connection with the implementation of education policies that must be addressed by school principals, teachers, students, and all school members, namely 1) Implementation of the National Examination, 2) Learning from Home, 3) School Exams, 4) Grade Promotion, 5) New Student Admissions, and 6). School Operational Assistance Fund.[2]

The policies that had been revolved by the Ministry of Education and Culture at least answered emerged problems, especially regarding the world of education. The Deputy for Education and Religion at the Coordinating Ministry for Human Development and Culture said that limited access to electricity and the internet was also a big obstacle in education enforcement during the pandemic. The minister informed that 46 thousand education units currently do not have access to electricity and the internet. According to him, this needs to be mitigated by collecting data and handling it from the relevant

---

<sup>81</sup> [abrarparinduri@staff.uma.ac.id](mailto:abrarparinduri@staff.uma.ac.id)

local government. He said the regional government must ensure that access to learning in its territory is facilitated.[3]

In addition to the problems above, Distance Education (PJJ) problem will also have a crucial impact on students who do not have internet access due to unavailable facilities or the influence of the geographical area where they live. Member of Commission X DPR RI Zainuddin Maliki suggested the Minister of Education and Culture move teachers to work 'door to door' or meet students directly to solve Distance Education (PJJ) problems for students in areas without internet access to electricity during the Covid-19 pandemic. The Minister initiated this step by established a Front Group of Education Service for Students in Frontier, Outermost, and Least Developed Regions During the Covid-19 Pandemic. This activator teacher will have to meet students door-to-door and not gathered to prevent more massive transmission of covid-19 virus. In carrying out these tasks, teachers should equip with Personal Protective Equipment (PPE), and the distribution of their duty schedule is given to each school.[4]

The teaching and learning process model that has applied to students in areas without internet access to electricity must be problem-based or project-based learning, not conventional. Each assigned teacher can form a team consisting of several courses, to ask students to study one learning topic. For example, learn about animal or plant species that surround their environment thematically. Each student is given about one week to solve a problem or complete an assigned project. This step is urgent to do to reduce interaction between students and teachers during the coronavirus pandemic. Teachers in a team formulate the reality that exists in society thematically. So that the learning system is thematic, one project can be evident by several teachers.[5]

In reality, teachers and students want learning activities in schools to reopen. This reality can be evidence in the results of a poll conducted by the Indonesian Child Protection Commission (KPAI) stating that majorities of teachers and students agree that teaching and learning activities will enforce again. However, at the same time, many parents do not concord that teaching and learning activities in schools are resumed. Of the 196,546 parental respondents, 129,937 or 66 percent disagreed. They are worried about being affected by the coronavirus pandemic (Covid-19). Only 66,609 or 34 percent agree. Meanwhile, of the 9,643 student respondents, 63.7 percent of them agree that teaching and learning activities in schools would be resumed starting the new school year in mid-July. Then, 54 percent of

the 18,111 teacher respondents agree that teaching and learning activities will be enforced in schools again in the new school year on July 13th while another 46 percent of teachers refused to conduct offline learning.[6]

Even in-future the school will reopen by paying attention to health protocols seems the problem is not solved. Considering that during the pandemic period, there were various kinds of violence experienced by children while they study at home. Based on Assistant Deputy for Child Abuse and Exploitation from the Ministry of PPPA stated, Valentina Ginting highlights child abuse cases that occurred during the pandemic going to increase. Based on data from the PPA Symphony, on 1 January-19 June 2020, there were 3,087 cases of child abuse with details of 852 physical abuse, 768 psychological, and 1,848 cases of sexual abuse. The PPPA Ministry admits that households are vulnerable during this pandemic. That is because many family members have to stay at home for a long time. Not to mention the economic problems due to loss of income and others.

The COVID-19 pandemic forces everyone to keep their distance, and it impacted every sector of life. Especially in education, students became the victims with abolishment face-to-face learning process and then replaced by learning from home. Online learning now a typical thing, despite many obstacles emerge, such as internet access and the readiness of parents to help their children while studying at home. The role of parents now is the main factor in students learning, so that children's interest in learning does not decrease even though the learning process had done online. The task of parents is increasing, namely not only educating children but at the same time replacing the role of teachers by accompanying them to study at home [7].

During the current pandemic, parents have more time to spend with their children increasingly. Hopefully, the children will grow and develop through the care provided by their parents. However, some parents who send their children to MAS Nurul Furqoon, Binjai City, never learn how to teach their children well, but the learning tends to be spontaneous. Parental involvement is urgent in helping children learn limitations, improving children's social relationships, and teaching children about learning importance. All good things have not been implemented for some of the guardians of students at MAS Nurul Furqoon Binjai.

## **Previous Studies**

Family education during the COVID-19 pandemic is expecting to play a role in helping children succeed in learning from home. Related research about the role of family education in online learning is an effective solution to activate classrooms, even though schools have closed due to high-risk times and places during this pandemic. However, the learning techniques that have does so far were urgent to evaluate. It considered the differences in the availability of learning facilities at home and the differences in the ability of parents to accompany their children to study at home.[8]

Previous research [9] revealed that the roles played by parents during the covid-19 pandemic were as mentors, educators, carers, developers, and supervisors. In particular, the role that emerges were: maintaining and ensuring children live clean and healthy lives, accompanying children in doing schoolwork, doing activities together while at home, creating a comfortable environment for children, establishing intense communication with children, playing with children, be a role model for children, provide supervision to family members, provide for and meet family needs, and guide and motivate children, provide education, maintain religious values, carry out variations and innovations in activities at home. This study recommends the importance of guidance for parents in assisting children with needs-based activities during the pandemic and studying at home.

Another research [10] reveals how parents participate in early childhood education while accompanying children to study at home. This study concludes with three things. First, student parents feel that learning at home was running effectively. It was because of school assignments can be assisted by parents at home. Second, learn facilities carried out at home were considered to still be able to increase the level of children's learning. Third, many parents agree that during the learning at home, parents participated to help their children do the assignments given by the teacher.

Research about how problems of student guardians in Muhammadiyah elementary school at Sidoarjo Regency in assisting online learning.[11] The results reveal that there are five problems ever faced by the guardians of students. First, the difficulties student's mentoring. Second, the student's load in learning is quite heavy. The third, the internet quota and network problems for online learning that weak. Fourth, the limitations of online learning media. And the last, the difficulty of conditioning children at home.

Research explains that home learning has now emerged as a substitute for conventional schools, which must be made effective for providing advantage learning skills for children at home despite using limited resources.[12] Parents should try to involve themselves with children by setting a strict schedule. By applied that, children know when it is time to study and when it is time to play. In addition, parents must try to involve themselves with children to assist them in learning by using creative ways according to parent's abilities. The limitations of parents with different education levels should provide lessons for schools to choose the right instrument for students in doing school assignments. Schools/teachers should have concrete data on the intellectual abilities of parents, making it easier for schools to make adjustments during online learning.

The subsequent research [13] revealed that more than 144 million students in Latin America and the Caribbean had missed nearly five months of school due to the effects of the COVID-19 pandemic. While governments across the region have implemented distance learning strategies intended to maintain a level of continuity in the learning and well-being of children and youth, these solutions have been applying unevenly. It may even further exacerbate the educational gaps that existed in the region before the pandemic. Addressing this education emergency requires the government to focus on ensuring the learning and well-being of children and youth, working on four priority areas. First, planning for school reopening. Second, develop strategies to ensure the learning for all students in a new context where not all instruction will be direct. Third, preserving the school's protective role and providing services that have been disrupting so far. Fourth, ensure the emotional well-being of the educational community (teachers, families, and students).

Based on the mentioned results above, a severe study should be conducted regarding how family education could play its role during the COVID-19 pandemic. Therefore, this study seeks to examine more deeply the role of family education during the COVID-19 pandemic. This research focuses on answer the problem of family education with single-parent status and intact family status in accompanying children while studying at home. How do parents build family attachment during the pandemic, and what strategies must parents prepare to construct a parent-child bond.

## **Results and Discussion**

The researchers used qualitative to produce data in the form of descriptive or verbal language.[14] The type of research used is a case study. The research had conducted at the parents' homes of students from January to March 2021. The presence of researchers became a measure of success or understanding of several cases. The researcher acts as the main instrument in data collection or as the key instrument. Data collection techniques used in this study were interviews, observation, and documentation. The interview technique used is a semi-structured interview. Interviews and observations had done conducted with three guardians of students with single parent status and three guardians of students with intact family status. In this research, single-parent parents were referred to as 1st informant, 2nd informant, and 3rd informant. While parents in intact families were referred to as 4th informant, 5th informant, and 6th informant.

Furthermore, data analysis technology uses an interactive model from Miles and Huberman. This study also uses triangulation to test the validity of the data. The triangulation method used is the method and source triangulation by examining interview notes, field notes, surveys, and document notes from various authoritative data sources.[15] The research sample was conducted on the parents of MAS Nurul Furqoon students in Binjai City by focusing on the status of single parents and whole families.

### **The meaning of education in the family**

Education carried out in the household or family environment is a form of informal education. Informal education is an educational cycle that has been obtained individually through daily experiences whether it has been obtained consciously or not. Informal education is not structured and has levels like formal education and non-formal education, because this education is unlimited (not limited in time). After all, it starts from individual birth until death. Philip H. Coombs suggests that individuals first get to know the environment from the family, and individuals also have the most time interacting with family life.[16]

The purpose of the presence of family education is that each family member can grow and develop optimally. The growth and development referred to in this case are based on their talents and abilities, so that individuals from a family can become independent human beings and are gainful for themselves and society. After the individual receives education from the family, the individual can

develop into a mature individual and expected to be able to understand the culture that evolves in society and become a human being who has noble character by applying the values of his belief or religion.

The benefits of family education [17] involve: First, education had obtained through experience and education acquired during the individual's golden age. Second, family education is assisting in the growth and emotional development of children. Third, parents are role models for their children. Through family education, parents should be able to shape their children to have noble character. Fourth, tolerances and cooperations can be taught in family education through the division of tasks given by parents to their children. Fifth, that in family education is the lead off of religious values that could have been implanted. Sixth, various soft skills could have been taught in family education to make children skilled and independent.

Instinctively, family education provides lessons about religious beliefs, cultural values, moral values, and skills. Religious belief is education about the internalization of religious values and beliefs, procedures for worship, and behavior as religious people both transcendentally and horizontally. Every family or parent wants their offspring to have the same religious beliefs as themselves. Parents hope that in terms of faith and piety, a child can surpass their parents. Cultural values in question are related to cultural values and behavior by the socio-cultural context in which the person concerned lives, accompanied by the ability to adapt in cultural development when the children grow up without losing their original cultural identity. Likewise, moral values were values that could be made a person behave ethically and aesthetically in the context of the physical and social environment of life. Meanwhile, what is meant by skills is related to attitudes, knowledge, and skills to survive in meeting physical, psychological, and social needs.[18]

### **Parent-Child Attachment**

Attachment is a term proposed for the first time by a psychologist from England named John Bowlby (in P, 2012). Attachment is a particular behavior found in humans, namely the tendency or desire of a person to get closer or seek closeness with others to get quench in social relations with persons. The first person that children prefer to construct attachment with is the mother (nanny), father, or close relatives. The attachment will long last, considered by the bond in particular and eternal over time. Parents and children are the most concrete examples of attachment. No matter



how bad the relationship between parents and children, they cannot be separated. But in fact that each of them will maintain communication intentions that could make things worse.

A child could be supposed attached to another person if it cannot be separated from the person. The attitude shown is usually feeling anxious when separated from the attached figure, happy when the attached figure comes back after separation, and the orientation remains on the attached figure even though they do not interact. Children will always pay attention to movement, listen to sounds, and try to get the attention of their attached figures as much as possible. Bowlby in Stevenson [19] explains that there are 3 (three) attachment patterns/styles, including First, secure attachment. This attachment pattern is the growth of trust between children and their parents as attached figures who can give a sense of security, love, responsiveness, and affection to their children. Second, resistant attachment (against/ambivalent pattern). This attachment pattern is a relationship that is not harmonious between children and their parents as attached figures because of the uncertainty that parents give to their children in terms of security, love, responsiveness, and affection. Third, avoidant attachment (avoiding patterns). This attachment pattern caused by parents who always avoid giving a sense of security to their children so that children will also reject their parents and look for other.

Based on the pattern/style of attachment described above, the researcher will elaborate further on the attachment pattern between parents and children while accompanying children to study at home due to the COVID-19 pandemic. To facilitate the objects of discussions, the researchers only focus on traditional families, which include whole families and single parents. An intact family is a family consisting of a father, mother, and children, while single parents are parents who had separated due to divorce or death. In general, single-parent raised their children without presence, support, and responsibilities from partner.[20]

### **MAS Nurul Furqoon Profile and Student Family Description**

Madrasah Aliyah Swasta (MAS) Nurul Furqoon Binjai is a private madrasa located at Jalan Jenderal Gatot Subroto No. 147 Bandar Senembah Urban Village, West Binjai District, Binjai City. This madrasa stands on an area of 1,531 M<sup>2</sup> with its status. This madrasa was built in 2011, with an operational permit Kw.02/5-d/PP.03.2/167/SK/2011. The current head of Madrasah is Lia

Ardyati, S. Pd. In the 2020/2021 academic year, MAS Nurul Furqoon Binjai has 81 students. The facilities in this madrasa consist of classrooms, bathrooms, madrasa head rooms, prayer rooms, sports fields, canteens, parking lots, teachers' rooms, administration rooms, and libraries.

Parents of students who are the object of this study are parents with students in Class X. The description of the families of students in class X who are the object of research is as shown in the following table:

**Table 1: 10<sup>th</sup> grade Students that life with Single-Parent Family**

<b>Students Name</b>	<b>Stay at Home With</b>	<b>Single -Parent Causal</b>	<b>Parents Occupation</b>
Hafiz Apta Widya Dhana	Mother	Divorced	Housewife
M. Rafli Ananda	Mother	Divorced	Housewife
Nairin Naila	Father	Widower	Soldier

**Table 2: 10<sup>th</sup> grade Students that life with Intact Family**

<b>Students Name</b>	<b>Parents Occupation</b>	
	<b>Father</b>	<b>Mother</b>
Alfiansyah Putra	Staff	Entrepreneur
Dila Anggita	Civil servants	Ibu Rumah Tangga
Laila Silvia br Sitepu	Entrepreneur	Housewife

As stated in the table above, it has known that there are differences in the type of family, namely families with single parent status (single parents) and whole families. To make it easier for researchers to study more deeply about how family education is during the covid-19 pandemic and how parents build an attachment to children while study at home, the research sample taken was only 6 (six) parents of students with details of 3 (three) people with single parent status and 3 (three) people with parental status who have an intact family.

### **Family Education Strategy and Parental Attachment to Children**

Based on the result from interviews with 1st informant, the informant regarding the family education given to their children during the covid-19 pandemic is related to religious values and moral values. Religious values referred to by 1st informant is that the child has expected to understand and interpret the lessons he gets from school. The purpose of 1st informant to send his child to MAS Nurul Furqoon is as part of the effort so that the child does not pursue in the

footprints of his parents who did not have time to attend religious school as well as possible. According to 1st informant, the household failure experienced by the mother should not affect the children's enthusiasm to study religion so that the child will be wiser in the future to face all the problems that occur in his life.

Regarding the moral values referred to by 1st informant are the values of goodness that apply in society. As a mother, 1st informant tries to keep an eye on her children as much as possible. It had done to ensure that her child does not fall into promiscuity and illegal drug abuse. According to 1st informant, there is no distinctive strategy that she does. She merely tries to increase the discussion with the child in her leisure time. By doing some discussion, will emerge the self-disclosure of children to their parents. Many children do not want to be open themselves, because parents also do not want to know about the activities of their children and their friends. By providing leisure for discussion, parents get much information from their child regarding their activities and made friends with.

Based on the result of observations made by researchers related to the pattern of attachment carried out by the 1st informant to their children is the pattern of secure attachment (safe form). On this pattern, the child looks comfortable when he is near his parents. It was because of the attention and care from his parents for him.[21] Parents still could show love and concern for the child in their way without making the child feel uncomfortable.[22] Through the attachment of the safe pattern carried out by 1st informant to her child, the mother only hopes that the child will become a person with good morals towards the family and social life. With this kindness, it has expected that all dreams that a child wants would achieve.

Furthermore, based on the results of interviews from 2nd informant regarding the family education strategy given to children during the pandemic, it is always to strengthen religious and moral values. Similarly, 3rd informant stated that religious values and moral values are part of family education which always give from parents to their children during the pandemic. 2nd informant and 3rd informant agree that religious values and moral values each bring the good of life for those who can carry it out well. According to 2nd informant and 3rd informant interview results, every parent certainly wants their child to be better than their parents in the field of work, religious understanding, and adaptability in social life.

Regarding the pattern of attachment of parents and children, based on the results of researchers' observations of 2nd informant

and 3rd informant they both show a form of resistant bond to their children. During the observance, the researcher did not find harmony between parents and children. In 2nd informant, the researcher found that the household failure he experienced seemed deeply agitate the communication between parents and children. The demands of life must continue to make it hard for parents to put the free time to communicate with their children even though the child lives with his parents. 2nd informant was worried about various kinds of news related to juvenile delinquency, but he was also not willing to take the time to communicate with children. As a result, the bond between parents and children does not go well.[23]

Likewise, 3rd informant due to busy work causes him to have no free time to discuss with his children. As it is known that 3rd informant's job as a TNI officer is indeed quite time-consuming and requires high discipline so that 3rd informant repeatedly feels guilty towards himself and his children who do not have enough time to build communication to create an attachment between parents and children. However, 3rd informant feels quite grateful because he lives in a settlement where all the residents are friendly and care about their children. 3rd informant continues to pay attention to the community and religious activities near his house in the hope that from the attention he gives, residents will continue to monitor the development of their children while the father is not at home.

Based on the result of interviews with the 4th informant and the 5th informant regarding the family education strategies they provide to children during the pandemic, it has known that each of them seeks to strengthen religious and moral values. The religious's value they understand is to ensure the child performs the prayer on time, while the moral value they understood is all good deeds that are acceptable to society. Through the practice of religious values and moral values, it has expected that the child would find peace in carrying out his daily activities.

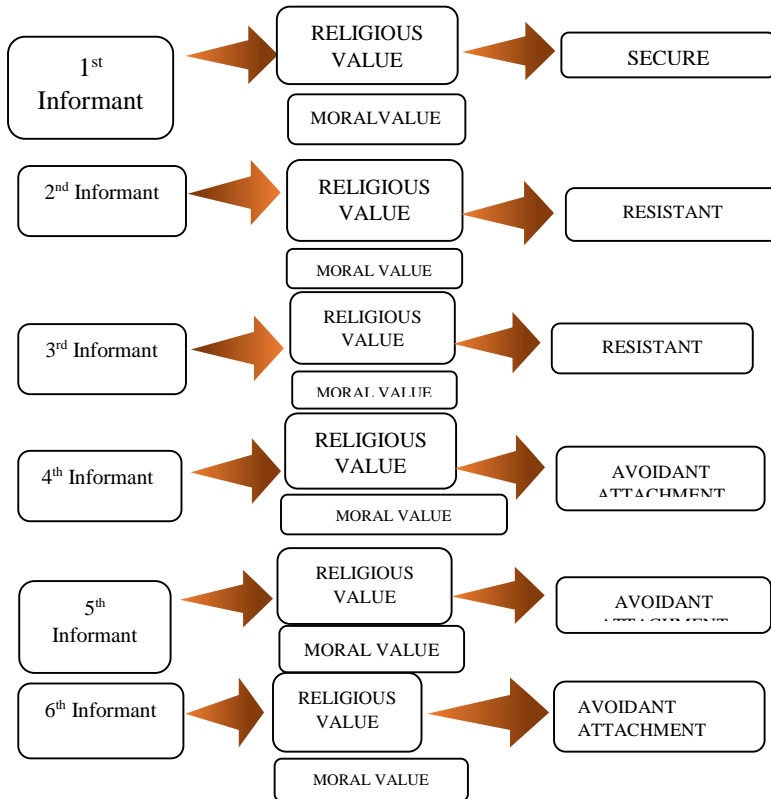
Regarding the strategy of building parent-child attachment during the researcher's observation of the 4th informant and 5th informant, the researcher found that the bond between parents and children tends to be in the avoidant attachment pattern. There is no harmony between what parents expressed in family education strategies and strategies to build a parental attachment to their children. This avoidance attachment pattern occurs because the researcher found a disharmony in the relationship between the two parents (father and mother) and has impacted the bond of parental

attachment to the child. Often the result of a husband and wife's selfishness is fatal to the mental development of children.[24]

Based on the results of interviews about family education strategies during the covid-19 pandemic, the 6th informant stated that there was no special strategy that they did but they only tried to instill moral values and cultural values. The moral value they understand is that their children always respect their family and have compassion for their fellow human beings. While the cultural values in question are a part of the Karo Batak tribes community, they have many cultural philosophies that are relevant to religious values and moral values such as the proverb: *ula kekurangan kala enca sipandangi, kekurangenta lebe pepayo* (don't always look at the shortcomings of other people but look at the shortcomings that exist within oneself).[25] According to the 6th informant, cultural values need to be introduced to children in the family environment so that they love the culture they have and live it to be part of the life they live.

From the 6th informant result interview about the pattern of attachment build by parents and children, the researcher has found that the pattern of attachment that occurs is a pattern of secure attachment that was good communication between parents and their children. Despite the Karo Batak tribe had known for its persistence in pursuing life goals, the 6th informant assumed it does not have to sacrifice children. For 6th informant, his duty as a parent was only to ensure that his child's goals and lives do not contradict the religious and moral values of the community. Reach out for the goal as high as possible but don't disturb other people, justify all means, and so on. According to the informant, the education he received from his parents since childhood has always taught him to have a gainful life for others. His parents never force their children to achieve particular goals or professions, but they require existence that brings benefits and does not harm the family or others only.

From the results of the interviews and observations above, the family education strategy and the attachment of parents to their children can refer in the chart below:



### Conclusion and Implications

The outbreak of the COVID-19 pandemic has brought the entire world community to a confusing and worrying situation. Especially for the two parents whose children are at MAS Nurul Furqoon, Binjai City, they also feel the same thing, namely confusion amid uncertainty when this pandemic will end soon. But there is hidden wisdom in every bad thing that had considered that brings a negative impact in general. The Covid-19 disaster has had a positive influence on some parents, namely the availability of plenty of time to accompany their children while studying at home. The cooperation of parents (father and mother) is required to capable to give a sense of their child's securities. Parental care and attention to children should not fade because it will interfere with children's mental development. The COVID-19 pandemic has also taught parents about the importance of building attachment to their children. There is no more hope that a child wants from his parents than the presence of love, responsiveness, and affection in the middle of their family.

### References

[1] Kemmdikbud, "Pedoman Penyelenggaraan Belajar dari Rumah

- Dalam Masa Darurat Penyebaran Corona Virus Disease (covid-19)," 2020. <https://bersamahadapikورونا.kemdikbud.go.id/wp-content/uploads/2020/05/SE-Sesjen-Nomor-15-Tahun-2020-2.pdf>.
- [2] Kemdikbud, "Pelaksanaan Kebijakan Pendidikan dalam Masa Darurat Penyebaran Covid-19," 2020. <https://www.kemdikbud.go.id/main/blog/2020/03/se-mendikbud-pelaksanaan-kebijakan-pendidikan-dalam-masa-darurat-penyebaran-covid19>.
- [3] CNN Indonesia, "PMK Sebut Corona Tak Berdampak Besar pada Angka Putus Sekolah," 2020. <https://www.cnnindonesia.com/nasional/20200708151423-20-522341/pmk-sebut-corona-tak-berdampak-besar-pada-angka-putus-sekolah>.
- [4] CNN Indonesia, "Mendikbud Diminta Waspada Ancaman Putus Sekolah Semasa Covid," 2020. <https://www.cnnindonesia.com/nasional/20200504081412-20-499675/mendikbud-diminta-waspada-ancaman-putus-sekolah-semasa-covid>.
- [5] CNN Indonesia, "Kemendikbud Buat Skenario Belajar di Rumah sampai Akhir 2020," 2020. <https://www.cnnindonesia.com/nasional/20200424114337-20-496861/kemendikbud-buat-skenario-belajar-di-rumah-sampai-akhir-2020>.
- [6] SindoNews, "Ribuan Kasus Kekerasan terhadap Anak Terjadi selama Pandemi Covid-19," 2020. <https://nasional.sindonews.com/read/79810/15/ribuan-kasus-kekerasan-terhadap-anak-terjadi-selama-pandemi-covid-19-1592975177>.
- [7] B. Whalley, D. France, J. Park, A. Mauchline, and K. Welsh, "Towards flexible personalized learning and the future educational system in the fourth industrial revolution in the wake of Covid-19," *High. Educ. Pedagog.*, vol. 6, no. 1, pp. 79–99, 2021, doi: 10.1080/23752696.2021.1883458.
- [8] L. D. Herliandry, N. Nurhasanah, M. E. Suban, and H. Kuswanto, "Pembelajaran Pada Masa Pandemi Covid-19," *JTP - J. Teknol. Pendidik.*, vol. 22, no. 1, pp. 65–70, 2020, doi: 10.21009/jtp.v22i1.15286.
- [9] R. Guetto and N. Panichella, "Family arrangements and children's educational outcomes: Heterogeneous penalties in upper-secondary school," *Demogr. Res.*, vol. 40, no. June, pp. 1015–1046,

- 2019, doi: 10.4054/DemRes.2019.40.35.
- [10] A. Lilawati, "Peran Orang Tua dalam Mendukung Kegiatan Pembelajaran di Rumah pada Masa Pandemi," *J. Obs. J. Pendidik. Anak Usia Dini*, vol. 5, no. 1, p. 549, 2020, doi: 10.31004/obsesi.v5i1.630.
- [11] I. Istikomah, T. Churahman, and ..., "Problematika Wali Murid Sekolah Muhammadiyah dalam Mendampingi Belajar Daring di Masa Pandemi Covid-19," ... *J. Pendidik. ....*, vol. 19, pp. 195–209, 2020, doi: 10.19105/tjpi.v15i2.3813.
- [12] S. Bhamani, A. Z. Makhdoom, V. Bharuchi, N. Ali, S. Kaleem, and D. Ahmed, "Home Learning in Times of COVID: Experiences of Parents," *J. Educ. Educ. Dev.*, vol. 7, no. 1, p. 9, 2020, doi: 10.22555/joed.v7i1.3260.
- [13] S. G. Jaramillo, "COVID-19 and primary and secondary education: the impact of the crisis and public policy implications for Latin America and the Caribbean," *Unicef*, no. 20, 2020.
- [14] L. J. Moleong, *Metode Penelitian Kualitatif*. Bandung: Remaja Rosdakarya, 2002.
- [15] Miles, M. B, and A. M. Huberman, *Analisis Data Kualitatif: Buku Sumber Tentang Metode-Metode Baru*. Jakarta: UI Press, 1992.
- [16] P. H. Coombs, "The World Educational Crisis," *Int. Rev. Red Cross*, vol. 9, no. 105, 2010.
- [17] A. Latif, *Pendidikan Berbasis Nilai Kemasyarakatan*. Jakarta: Raja Grafindo Persada, 1997.
- [18] Supriyono, H. Iskandar, and Sucahyono, *Pendidikan Keluarga dalam Perspektif Masa Kini*. Jakarta: Kementerian Pendidikan dan Kebudayaan, Direktorat Jenderal PAUD dan Pembinaan Masyarakat, 2015.
- [19] J. Stevenson-Hinde, "Attachment theory and John Bowlby: Some reflections," *Attach. Hum. Dev.*, vol. 9, no. 4, pp. 337–342, 2007, doi: 10.1080/14616730701711540.
- [20] D. Sujana, *Peranan Keluarga dalam Lingkungan Masyarakat*. Bandung: Remaja Rosdakarya, 2006.
- [21] J. Leigh and V. N. Anderson, "Secure attachment and autonomy orientation may foster mindfulness," *Contemp. Buddhism*, vol. 14, no. 2, pp. 265–283, 2013, doi: 10.1080/14639947.2013.832082.
- [22] U. P, *Psikologi Perkembangan*. Jakarta: Erlangga, 2012.
- [23] L. McFarland-Piazza, N. Hazen, D. Jacobvitz, and E. Boyd-Soisson, "The development of father-child attachment: Associations between adult attachment representations, recollections of childhood experiences and caregiving," *Early Child Dev. Care*, vol.



- 182, no. 6, pp. 701-721, 2012, doi: 10.1080/03004430.2011.573071.
- [24] T. Li and H. H. Fung, "How avoidant attachment influences subjective well-being: An investigation about the age and gender differences," *Aging Ment. Heal.*, vol. 18, no. 1, pp. 4-10, 2014, doi: 10.1080/13607863.2013.775639.
- [25] A. Yunus, S. Maria, and E. T. Ginting, *Makna Pemakaian Rebu dalam Kehidupan Kekerabatan Orang Batak Karo*. Jakarta: Departemen Pendidikan dan Kebudayaan, Direktorat Jenderal Kebudayaan, 1994.

# **Implementation of Digital Marketing as Integrated Marketing Strategy for Small and Medium Business Products in Palopo City**

Muhammad Aqsa<sup>82</sup>, M. Risal<sup>83</sup>

## **Introduction**

The rapid development of technology, the digital world and the internet of course also has an impact on the world of marketing. The marketing trend in the world has shifted from what was originally conventional (offline) to digital (online). Digital marketing is more prospective because it allows potential customers to obtain all kinds of information about products and transact via the internet. The digital era is indeed impossible to avoid, several marketing experts say that if they want to survive, MSME actors must be able to maximize the benefits of digital development.

According to data released by We are Social, a digital marketing agency in America, explaining that as of January 2020, as many as 48% of internet users in Indonesia search for goods or services online, 46% of users visit online stores, 41% of users make product transactions. or serving online services, 34% of users make online transactions via a computer or laptop, and 33% of users make online transactions via mobile devices such as smartphones. This implies that the potential for online shopping has been sufficiently developed in Indonesia which must be balanced with digital marketing as well by business actors.

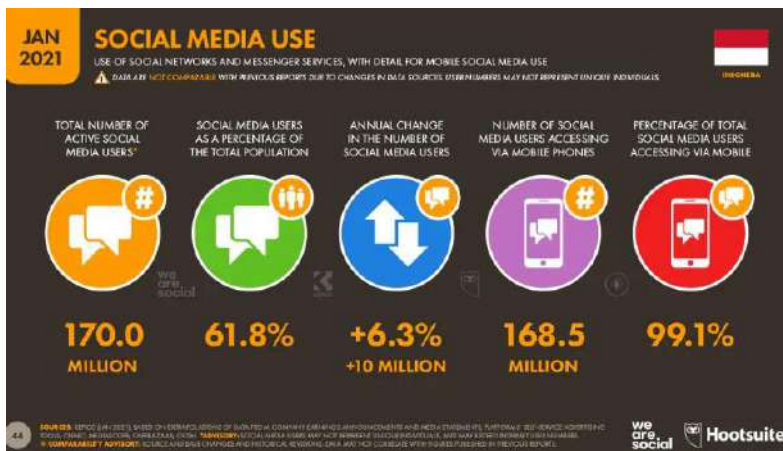
Micro, Small and Medium Enterprises (MSMEs) in Indonesia are said to be growing very rapidly. In mid-2016, the number of MSMEs in Indonesia had reached 57.9 million. According to the Deputy for Production and Marketing at the Ministry of Cooperatives and Small and Medium Enterprises, I Wayan Dipta, this number has the potential to go international. The government itself is fully pushing so that these MSMEs can go international. One way is to teach using the internet which is one way to facilitate marketing to international markets. Moreover, the era of demographic bonus that Indonesia will soon face in 2020-2035, will have the impact of intense competition. If there is no support from policy makers, MSMEs will be unable to compete with outside competitors.

---

<sup>82</sup> Magister Management Universitas Muhammadiyah Palopo

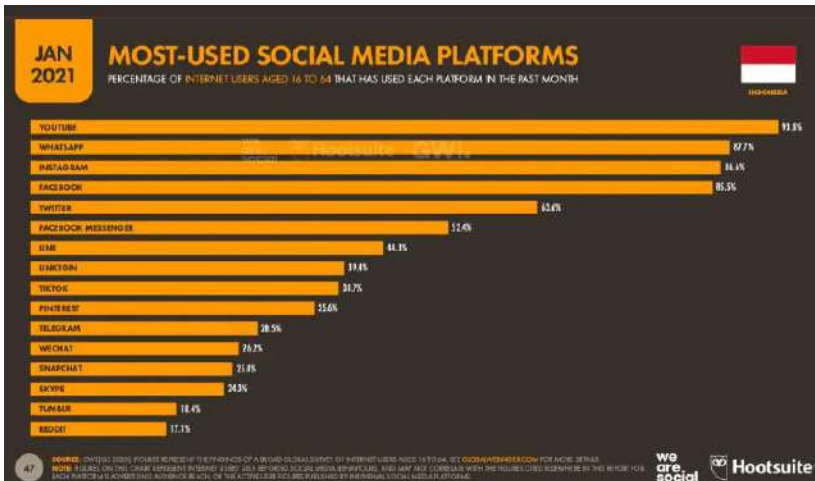
<sup>83</sup> Magister Management Universitas Muhammadiyah Palopo

In line with Press Release No. 216/HM/KOMINFO/11/2017 by the Ministry of Communication and Information (KOMINFO) regarding Go Digital! The National MSME Go Online Movement on November 7 2017. This movement supports Indonesia's economic vision in 2020, which is to become "The Digital Energy of Asia" with a target of growing E-Commerce transactions of USD 130 billion. In pursuing this vision, two main challenges must be faced that must be solved in a balanced and simultaneous manner, namely globalization and a just and productive economic system that favors the people as well as ensuring a fair and independent economic incentive system. This is also accompanied by an increase in social media users in Indonesia by 170 million social media users in Indonesia with a percentage of 61.8% of the total population of Indonesia.



**Figure 1**  
**Percentage of Social Media Users in Indonesia**

The platforms that are often used in digital marketing are social media or social networks. Data from We are Social also stated that the most widely used social media platforms in Indonesia as of January 2021 were Youtube (93%), Facebook (85%). The next position is occupied by Instagram (86%), Twitter (63%), Whatsapp (87%), and TikTok (38%). The rest are placed sequentially by FB messenger, LinkedIn, and other platforms.



**Figure 2**

**Percentage of Most Used Social Media Platforms**

Through a survey by the Indonesian Internet Service Providers Association (APJII), the growth of internet penetration in Indonesia has reached 54.68% throughout 2020. Of the total 262 million Indonesian population, 143.26 million people are estimated to have used the internet, both from desktop computers , mobile device, or from other facilities. Of course, promotions that use the internet are increasingly becoming an irresistible choice considering the growth in the number of internet penetration in Indonesia itself. By utilizing the internet as a communication medium in marketing products or services, it is expected to be able to reach a wider market so that more and more people know and can buy the products or services offered. Especially with the lifestyle of people in Indonesia who can not be separated from the gadget.

One of the effective strategies in "capturing" consumers is digital marketing (digital marketing). This is an important element needed in today's business world. Digital marketing is then often interpreted as a way of promoting or marketing a product or service through digital media. Over the past few years, this is a new creative approach for consumers, especially to create a pleasant impression. The rapid development of technology, especially in the field of information, has created opportunities for creativity and innovation in the MSME business.

Along with changes in people's behavior that pays more attention to the internet, it becomes a challenge for MSMEs to market

their products online. Consumers are more actively looking for what they want using online media, because they can access various information more easily than before. As for digital marketing, all business owners (MSMEs) do not only have to promote products in a clear way. In essence, digital marketing can include the ability to do many things that can reach consumers. In the end, this consumer experience will then lead them to the brand and product of the business owner. In terms of brand recognition, digital marketing is an effort to build brand awareness, which brings in revenue (sales). That's why, in order to properly target consumers.

Based on this data, business owners can determine strategies to build meaningful conversations with their customers. This is commonly referred to as Integrated Marketing Communication, which is a marketing communication planning concept that evaluates the strategic role of various communication disciplines, such as general advertising, personal selling, direct marketing, public relations, and combines these disciplines to provide clarity, consistency and maximum communication impact through comprehensive integration.

This has increasingly made researchers interested in conducting research related to the Application of Digital Marketing as an Integrated Marketing Strategy for Products of Micro, Small and Medium Enterprises (MSMEs) in Palopo City so that they can improve the economy in Palopo City.

## **Discussion**

### **Digital Marketing**

Digital marketing in this study, namely the application of marketing communications through digital media, especially through the internet, for example the use of social media, in this case such as Facebook and Instagram. Strategy is a careful and systematic way of an activity to achieve specific goals. According to [1], in designing an integrated marketing communication strategy, companies must combine the various elements contained in the promotional mix by taking into account the strengths and weaknesses of each of these elements. All elements of the marketing mix must be consistent with the strategic plan that will result in an integrated marketing communications program.

In marketing, [8] explain that the marketing communication strategy is divided into three main activities, namely planning, implementing, and evaluating an integrated marketing

communication program. The integrated marketing communication strategy is divided into three main activities, namely planning, implementing, and evaluating integrated marketing communications.

The digital marketing strategy using social media is very important because it can provide knowledge to MSME actors about the ways and stages in expanding consumer networks through the use of social media in marketing their products so that they can increase competitive advantage for MSMEs themselves. The use of the internet has changed most of the concepts of marketing which previously only relied on the marketing mix consisting of product, price, place and promotion, but the current development is an addition to the basis of marketing, namely the 4C approach consisting of customer, cost, convenience and communication. Businesses must consider costs to maximize profits and use the internet to make consumers comfortable, because consumers can buy products only from home, and companies need to develop two-way communication to form good relationships with customers.

### **Micro, Small and Medium Enterprises (MSME) in Palopo City**

Based on the results that have been obtained through in-depth interviews and observations with informants who are MSME actors in Palopo City. Technological developments make MSME actors need to adapt, especially in the marketing process. Digital marketing by utilizing social media, social chat, marketplace and the use of other platforms, makes it easier for MSME actors to be able to attract and interact directly with consumers. Several MSME actors who became informants in this study consisted of various industrial categories including food and beverage, fashion, retail, and creative industries. MSME actors stated that the use of technology made them feel helped, especially now that all consumers are active on social media and consumers today tend to choose to shop via online.

**Table 1. Palopo City MSME Informant Data**

No	Business Name	Type of business
1	YOTTA!	Health Drink
2	SOLATA CAFE	Cafe&Restaurant
3	DOMPIS BERLIN THRY	Traditional Snack
4	ALFARISIAN	Printing
5	FINLEYS	Barbershop
6	RAIVHA SYARII	boutique

7	PALOPO BANANA	Banana Snacks
8	PALOPO FLOWER BUCKET	Florist
9	TUUK TEA	Drink
10	NIACAKEE	Food
11	FLIES PALOPO	Clothes
12	DWE.STOR	Veil
13	CHICKEN Dumplings	Food
14	HOME DRESS	Clothes
15	RICE BOWL	Food

All MSME actors use social media as a means to provide information and interact with consumers, from some MSME actors use social chat to interact and provide information to customers and some MSME actors use marketplaces such as Shopee, Tokopedia and Lazada and other platforms such as product availability in the application. Go-Food and the use of YouTube as a promotional medium by MSME actors.

**Table 3. List of Digital Marketing Platforms Used**

No	Digital Marketing Platforms	Total	Percentage
<b>1</b>	<b>Social media</b>		
	• Instagram	12	100%
	• Facebook	8	67%
	• Youtube	2	17%
<b>2</b>	<b>Social Chat</b>		
	• Whatsapp	10	83%
<b>3</b>	<b>Marketplace</b>		
	• Shopee	7	58%
	• Tokopedia	2	17%
<b>4</b>	<b>Other platforms</b>		
	• Go-Jek	5	41%
	• Go-Food	7	58%

Some MSME actors update information both on social media and on other platforms, namely once every day as much as 67% and MSME actors usually update their product information every hour and every week. With the increasing frequency of SMEs in updating product information, it will encourage consumers to buy their products. Like what Yotta did, Yotta almost every hour posts their

products and promotions through Instagram because consumers from Yotta are not only from the Palopo area but also in several areas in South Sulawesi such as Makassar, Maros, Gowa, Parepare, Pangkep, Bone.

The results of interviews with informants who are MSME actors in Palopo City, are based on the 4C approach consisting of cost, customer, convenience, and communication. MSME actors agree that digital marketing helps them to promote and market their products effectively. The informants argue that digital marketing makes them save on promotion costs because so far they still rely on online marketing such as distributing brochures, advertising in newspapers and advertising through billboards, their expenses will be greater when they use offline marketing. This is also reinforced by previous research which states that internet marketing expands market reach, lowers marketing costs and improves good relationships with customers [9].

Several informants agreed that digital marketing provides cost savings, increases interaction with customers and provides convenience. MSME actors need to pay attention to the effective marketing process used at this time. Some of the things that informants do is update information through social media, websites, marketplaces, special customer groups and so on, on average they update information once a week because it is to retain old customers and attract new consumers to buy their products. With the internet they can save costs for promotion, because when they use social media they only need internet quota and those who have a special budget for advertising through digital they can use google adsense, facebook ads, instagram ads and so on.

The results of interviews with several informants of MSMEs in Palopo City stated that promoting through digital media made their sales increase, this was influenced by the convenience of consumers in accessing MSME information and the ease of ordering products. The use of internet marketing can also increase sales even in very remote locations. Several informants agreed that digital marketing makes their sales increase from 30% to 100% because digital marketing expands consumer reach and makes it easier for consumers to access information that has been provided on social media, websites, and on other platforms.

Some MSME actors need to collaborate with marketplaces such as Shopee and Tokopedia so as to make consumers from all over Indonesia able to buy MSME products in Palopo City, MSME actors in



the food and beverage category collaborate with Go Food and Go Jek so that consumers can order food and drink. drinks without the need to come directly to the shop, consumers can buy through the application and the drivers from both applications will deliver the order to the buyer's house.

## **Conclusion**

All MSME actors in Palopo City stated that the use of digital marketing helped them in informing and interacting directly with consumers. All MSME actors in Palopo City said that the use of digital marketing expanded their market share, increasing awareness for consumers because MSME actors regularly update information about products and increase sales because some MSEs also collaborate with several marketplaces, then MSME actors in the food and beverage category collaborate with applications. GoFood making it easier for consumers to buy their products.

Some recommendations that can be given regarding the application of digital marketing for SMEs in Palopo City are:

1. It is hoped that MSME actors can use social media as a means of promotion, selling and interacting with consumers. Some MSME actors have used social media as a means of promotion and sales but have not been managed optimally and effectively.
2. It is recommended that MSME players collaborate with marketplace platforms such as shoppe or tokopedia so that the market share can be wider. Palopo City SMEs have collaborated with platforms such as Go-Food.
3. It is recommended that the Palopo City Government and MSME actors can collaborate so that they can increase the productivity and sales of Palopo City MSMEs
4. It is recommended for the Government to create and design a website and play store platform so that it can make it easier for consumers to find Palopo City MSME products in one container and have a wider reach.

## **References**

- [1] Aditya Wardhana. (2015). Digital Marketing Strategy and Its Implications on the Competitive Advantage of MSEs in Indonesia. In National Seminar on Finance and Business IV (pp. 327–337). Indonesian education university.
- [2] Ali, H. (2013). Marketing and Selected Cases. Yogyakarta: CAPS.
- [3] Arikunto, S. (2010). Research procedure: A Practical Approach.

- (Revised Edition). Jakarta: Rineka Cipta.
- [4] Canavan, O., Henschion, M., & O'Reilly, S. (2007). The use of the internet as a marketing channel for Irish specialty food. *International Journal of Retail and Distribution Management*. <https://doi.org/10.1108/09590550710728110>
  - [5] Chaffey, D., Chadwick, FE, Mayer, R., & Johnston, K. (2009). *Internet Marketing: Strategy, Implementation, and Practice*. United States: Prentice Hall.
  - [6] Ministry of Industry. (2016). Economic Growth Encourages MSE Expansion. Retrieved from <http://www.kemenperin.go.id/article/5774/EconomicGrowth-DorongExpansion-UMK>
  - [7] Kominfo. (2013). Kemkominfo: Internet Users in Indonesia Reach 82 Million.
  - [8] Kotler, P., & Keller, KL (2008). *Marketing Management* (13 Volume 1). Jakarta: Erlangga Publisher.
  - [9] Pradiani, T. (2017). Effect of Digital Marketing Marketing System on Increasing Sales Volume of Home Industry Products. *Jibeka Journal*, 11(2), 46–53.
  - [10] [https://www.canva.com/design/DAEgJHFFpiw/YKolt-zKvvhHhDKG2NmMw/view?utm\\_content=DAEgJHFFpiw&utm\\_campaign=designshare&utm\\_medium=link&utm\\_source=publishpresent](https://www.canva.com/design/DAEgJHFFpiw/YKolt-zKvvhHhDKG2NmMw/view?utm_content=DAEgJHFFpiw&utm_campaign=designshare&utm_medium=link&utm_source=publishpresent).

## **Sustainable Development 4.0 in Indonesia: eTOURISM, eMOBILITY, eCITIES and eDESA**

Muhammad Ikhsan Setiawan<sup>84</sup>, I Nyoman Sudapet<sup>85</sup>, Agus Sukoco<sup>86</sup>, Ronny Durrotun Nasihien<sup>87</sup>, Che Zalina Zulkifli<sup>88</sup> and Mohd Idrus Mohd Masirin<sup>89</sup>

### **Introduction**

Sustainable Development are 17 global goals set out in the 2030 Agenda for Sustainable Development, adopted by the United Nations in 2015, for peace and prosperity for people. 17 Sustainable Development Goals (SDGs), ending poverty, deprivation, improving the quality of health and education, reducing inequality, increasing economic growth, climate change and conserving oceans and forests. Industry 4.0 is used as a new industrial paradigm that includes a series of industrial developments in the future using the latest technological elements that allow the industrial environment to be more intelligent. Tourism 4.0 started from the adaptation of the tourism industry, which followed the eruption of industrial developments in general. Tourism 4.0 emerged and developed from government circles, professionals, and practitioners in contrast to Smart Tourism and Smart Destination, which have developed among academics through more research than tourism 4.0. In Indonesia itself, Tourism 4.0 is Millennial Tourism born along with big data technology, travelers' behavior collected via apps & sensors, processed to create a seamless & personalized traveling experience.

The application of sustainable mobility 4.0 uses information technology to develop public transportation based on geographic information systems to increase the competitiveness of regional development. Also eCities or Cities 4.0, for analysis the city green space corridor is an urban park connector that connects green open spaces in every city. The passages are created by planting large trees and potential green areas, such as pedestrians, river borders, the banks of water bodies and reservoirs, railroad borders, and can be

---

<sup>84</sup> Narotama University, Surabaya, [ikhsan.setiawan@narotama.ac.id](mailto:ikhsan.setiawan@narotama.ac.id)

<sup>85</sup> Narotama University, Surabaya, [nyoman.sudapet@narotama.ac.id](mailto:nyoman.sudapet@narotama.ac.id)

<sup>86</sup> Narotama University, Surabaya, [agus.sukoco@narotama.ac.id](mailto:agus.sukoco@narotama.ac.id)

<sup>87</sup> Narotama University, Surabaya, [ronny.durrotun@narotama.ac.id](mailto:ronny.durrotun@narotama.ac.id)

<sup>88</sup> UPSI, Malaysia

<sup>89</sup> UPSI, Malaysia

used as motorized vehicle transportation and eco-friendly city tourism routes. Include in Sustainable Development, eDesa or Desa 4.0, is a concept of intelligent economy and tourism integration. It is part of the global master plan for sustainable development goals (SDGs), which integrates eDesa research products, innovative economy, and digital-based tourism to improve people's welfare. The method for compiling the eDesa application will start from secondary data collection, data analysis, digital data compilation, eDesa geographic information technology preparation, innovative economy and tourism integration, MSMEs, and regional economy form of web GIS and mobile GIS (Android). [1]–[6]

## **Discussion**

IoT internet of thing, Digital live and Web-based applications are gaining popularity along with the number of active internet users around the world. Apart from being easy to access, the website also does not require considerable resources in terms of hardware or software. In terms of ease of use, everyone can use a website application. Web-based applications and their advantages over desktop-based applications. Currently, desktop devices have begun to be replaced with websites that are more user-friendly and widely known to the public. Thus, many new web programmers and startups have sprung up in software houses for website development. Web-based applications are developed using HTML, PHP, CSS, and JS languages that require a web server and browser to run, such as Chrome, Firefox, or Opera. Web applications can run on the internet or intranet (LAN network). Centralized data and ease of access are the main characteristics that make Web Applications more popular and easier to implement in various areas of life. [1]–[6]

eCities application is not only web-based but also Android-based mobile. The web-based eDesa application can be visited at <http://ecities.worldsdg.info> . It is helpful to make it easier for users to access data as if from an Android mobile. There is a dashboard that displays data in tabular form for each menu. The green area menu displays information on green land in urban areas that are connected to transportation centers. The airport menu provides departure and arrival information, the same as the seaport menu. The terminal menu includes information on the distance from the terminal to the airport, seaport, and the bus station. Finally, the menu for the Regional Revenue and Expenditure Budget (APBD), Regional Gross Domestic Revenue (Regional GDP), and Bank Indonesia (BI) displays

information on matters related to economic data. eCities application consists of ten main menus: dashboard, green area, cities tourism, airport, seaport, bus terminal, train station, APBD, Regional GDP, and BI. Each menu will, of course, display different information. The eCities application is also designed for responsive mode. It is done to access data easily from various mobile devices or computers with different screen sizes. The main page for the graphical user interface (GUI) of the eCities application. It is divided into several sections, including the header section and the content section.

The eCities application logo is found in the header section. Meanwhile, the content section has several menus. The menu itself is divided into two parts, namely, for icons and labels. The dashboard menu helps present information in graphs from each of the available data. The data for 2020 is available on arrivals and departures of seaports and airports, the number of passengers in units of people and goods, financial services, insurance services, educational services, company services, and water supply. Other data that can be found are Regional GDP, APBD, and Bank Indonesia. The green area menu helps display the geographical location and extent of green land. It also shows the information on the distance of the green land to the airport and the seaport. The cities tourism menu helps know the distance between tourist areas and transportation centers, namely airports and seaports. The city tourism menu is also equipped with photos or location images to make it easier for users to see the location visually. For more details, see the following image. [7]-[19]



**Figure 1. eCITIES Website and Android Menu**

eDesa application is a concept of intelligent economy and tourism integration. The web-based eDesa application can be visited at <http://edesaworldsdg.info>. It is part of the global master plan for sustainable development goals (SDGs), which integrates eDesa

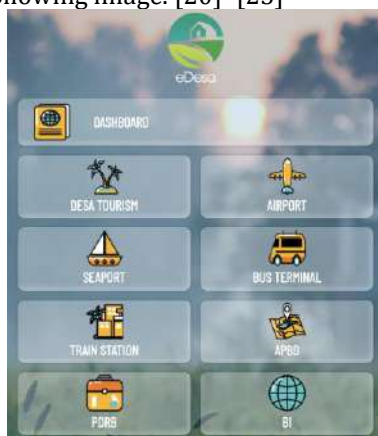
research products, innovative economy, and digital-based tourism to improve people's welfare. The method for compiling the eDesa application will start from secondary data collection, data analysis, digital data compilation, eDesa geographic information technology preparation, innovative economy and tourism integration, MSMEs, and regional economy form of web GIS and mobile GIS (Android). eDesa web-based application consists of several menus, such as the dashboard, which displays data in tabular form, and the tourism village, which displays village map information to the transportation center.

In addition, there are also airport menus and seaport menus that inform departure and arrival schedules. Meanwhile, the station menu and terminal menu show the distance from the terminal to the airport and port. Finally, there is a menu of APBD, Regional GDP, and BI. They show things that are related to data related to the economy. The implementation of the eDesa application uses a multiuser database, namely a MySQL database which has the advantage of a database server with a capacity of 1 terra bytes. The use of the database can be directly multiuser, which can be accessed simultaneously at the same time. The information contained in the eDesa application will make it easier for users to access data anywhere and any time as long as there is an internet connection on the access device. The information presented will be up to date to make it easier for users or related parties to plan village development activities for the community's welfare. Some other advantages when using web-based applications are that it makes it easier to share data in real-time and communicate about the information presented in the system. Web-based servers have better performance than desktop or local servers, so they are safe when used by multiple users.

Storing data in a web-based system is also more secure than on a desktop, where the data is spread across various databases. The risk of data loss and damage on a web-based system is also less than a hard drive. You can specify which users can access specific data so that people who are not granted access rights will not open it. Since a dedicated administrator manages the web-based system, various errors and glitches can be anticipated and corrected immediately. The eDesa application is not only web-based but also android mobile. It is helpful to make it easier for users to access Android mobile data. Similar to web-based, mobile-based eDesa also uses the same menus. The mobile-based eDesa application consists

of several menus, such as the dashboard, displaying data in tabular form—the tourism village, which shows village map information to the transportation center. In addition, there are also airport menus and seaport menus that inform departure and arrival schedules. Meanwhile, the station menu and terminal menu show the distance from the terminal to the airport and port. Finally, there is a menu of APBD, Regional GDP, and BI.

The eDesa application consists of nine main menus, including the dashboard menu, tourism village, airport, seaport, bus terminal, train station, APBD, Regional GDP, and BI. Each menu will, of course, display different information according to the available data and information. The eDesa application is designed with a responsive mode to make it easier for users to access various mobile devices or computers that use different screen sizes. The main page for the application's graphical user interface (GUI), divided into several sections, including a header section and a content section. The eDesa application logo is found in the header section, and application menus are in the content section. The menu section itself is divided into two parts, namely, for icons and labels. The dashboard helps present information in graphical form of each available data. The data available is for the year 2020 for each type of data. There are data on arrivals and departures of seaports and airports, the number of passengers in units of people and goods, financial services, insurance services, education services, company services, water supply, and Regional GDP, APBD, and Bank Indonesia. For more details, see the following image. [20]–[25]



**Figure 2. eDESA Website and Android Menu**

eMobility uses information technology to develop public transportation based on geographic information systems to increase the competitiveness of regional development not only in East Java, but also in Indonesia. The web-based version, you can visit the URL page <https://emobility.worldsdg.info/> . This e-mobility application uses dual versions, namely a web-based version and an Android mobile-based version. This sustainable mobility or e-mobility application can also be downloaded on the Android Playstore with the status of freeware or free. This e-mobility application offers several advantages. Android-based e-mobility applications do not require high mobile device specifications and run on all types or types of Android OS (Operating System).

Users who are still using the Android OS type version 4 (four) up to the latest version at this time, version 10 (ten), can still use it. Likewise, when installing or installing the system on each user's device. By searching with the keyword 'e-mobility on google play store, it will automatically find the sustainable mobility e-mobility application. Users can directly install the same as Android applications in general. This e-mobility application consists of 6 (six) main menus, including the airport, seaport, terminal, station, GRDP, or Gross Regional Domestic Product menu and the info menu. Each menu will, of course, display different information according to the available data and information. The e-mobility application is designed in the responsive mode to make it easier for users to access from various mobile devices or computers that use different screen sizes.

The airport menu is divided into sub-menus information on baggage, goods, passengers, aircraft, and postal packages. Of course, each of these menus will have a different display and presentation of information. The airport menu will also be presented on a digital map, making it easier for users to access or search for airports according to their geographical location. This e-mobility application, also equipped with a geographic information system, uses a digital map service licensed by Google Maps. In the digital map section, you can click on the name of the airport or airport so that information about the airport's name will appear. Users can click the zoom-in and zoom-out buttons to use the map freely as they wish. The seaport menu is divided into several sub-menus of information: the number of units, GT number, arrivals, departures, national unloading, foreign unloading, and foreign loading. Of course, each of these menus will have a different display and presentation of information.



The seaport menu will also be presented on a digital map, making it easier for users to access or search ports according to their geographical location. This e-mobility application, also equipped with a geographic information system, uses a digital map service licensed by Google Maps. The station menu is useful for displaying information on the location of train stations in various regions. The station menu will also be presented on a digital map, making it easier for users to access or search for train stations according to their geographical location. This e-mobility application, also equipped with a geographic information system, uses a digital map service licensed by Google Maps. The following is a display of the station menu which also has a Google Maps digital map feature. In the digital map section, you can click on the train station's name in each region so that information about the station's name will appear. Users can click the zoom-in and zoom-out buttons to use the map freely as they wish. The terminal menu is useful for displaying information on the location of bus terminals in various regions.

The terminal menu will also be presented in a digital map, making it easier for users to access or search for bus terminals according to their geographical location. This e-mobility application, also equipped with a geographic information system, uses a digital map service licensed by Google Maps. The following is a display of the terminal menu which also has a Google Maps digital map feature. In the digital map section, you can click on the name of the bus terminal in each region so that information about the name of the terminal will appear. Users can click the zoom-in and zoom-out buttons to use the map freely as they wish. The Regional Gross Domestic Product menu (Regional GDP) is a menu that is useful for displaying information on the Regional GDP of an area. Like the previous menu, the presentation of information is packaged in a table consisting of several columns, including the region's name, nominal in billions of Rupiah, airport, port, and the distance between the airport and the port. More details can be seen in the following display [26]–[31]



**Figure 3. eMOBILITY Website and Android Menu**

Tourism 4.0, web-based version, you can visit the URL page <https://ewisata.worldsdg.info/>. Augmented Reality technology can allow tourists to carry out activities such as booking hotels, accessing information while at the destination, navigating to and around destinations, translating writing or signs and conversations, finding alternative dining and entertainment options, only through the application on a mobile device or smartphone. Virtual Reality (VR) is a technology that allows users or users to interact with the environment in a virtual world that is simulated by a computer. Users feel that they are in an environment in tourism 4.0; virtual reality has a huge role.

The visible trend is that tourists are starting to show great interest in this technology, along with tourist attractions that use this technology as an artificial tourist attraction instead of an attraction in actual reality. Mixed Reality (MR) merges the real and virtual worlds to produce new environments and visualizations using holographic technology. MR allows tourists to visualize virtual objects as objects in front of them and interact with them. MR is a new technology from the development and improvement of AR and VR technology. This MR technology was initiated by Microsoft, which developed a product called Microsoft HoloLens. By looking at these conditions, it will be predictable that this technology in the future

will be very developed and in great demand by tourists. Technology-based Business Models are tourism business models that adopt digital technology from upstream to downstream.

This business model, significantly developed in the tourism sector, integrates networks between sellers and buyers. Mobile Technology is a technology that encourages innovation and monetization in the field of tourism service providers. The integration of mobile technology in tourism will make it easier for visitors or tourists to carry out activities before they come to the destination, at the destination, and after. At least four mobile devices can be integrated into the tourism sector, such as smartphones, smartwatches, bracelets, and glasses. Chatbots are chat services using an automated system or autoresponder. If in a standard chat service, media chat only becomes a chat tool between humans, which means we chat with interlocutors or reply to our conversations. Suppose the chatbot that reacts to the conversation or response is a robot set up as an autoresponder.

Android-based Tourism 4.0 applications do not require high mobile device specifications and run on all types or types of Android OS (Operating System). Users who are still using the Android OS type version 4 (four) up to the latest version at this time, version 10 (ten), can still use it. The tourism menu is divided into two sub-menus, namely the tourism menu and the airport menu. The tourism menu will also be presented in digital maps, making it easier for users to access or search for tourist distances to airports and ports. This eWISATA application, also equipped with a geographic information system, uses a digital map service licensed by Google Maps. This tourism page displays information on tourist destinations in Indonesia by being presented in digital maps based on GPS and information on the distance between tourist destinations to the airport and the airport. The info menu consists of three sub-menus, namely Regional Gross Domestic Product (Regional GDP) Non-Central Business District (CBD), Regional Gross Domestic Product (Regional GDP) Central Business District (CBD), and Regional Budget (APBD). Of course, each menu will have a function with a different data presentation. Each of these menu will appear sub-menu again according to the menu group. More clarity and detail can be seen in the following image. [1], [5], [40], [32]–[39]



**Figure 4. eWISATA Website and Android Menu**

## **Conclusion**

The 2030 Agenda for Sustainable Development, adopted by the United Nations in 20. 15, for peace and prosperity for people. 17 Sustainable Development Goals (SDGs), ending poverty, deprivation, improving the quality of health and education, reducing inequality, increasing economic growth, climate change and conserving oceans and forests Tourism 4.0 or eTourism or eWisata started from the adaptation of the tourism industry, which followed the eruption of industrial developments in general, emerged and developed from government circles, professionals, and practitioners in contrast to Smart Tourism and Smart Destination, which have developed among academics through more research. In Indonesia itself, Millennial Tourism born along with big data technology, travelers' behavior collected via apps & sensors, processed to create a seamless & personalized traveling experience.

The application of sustainable mobility 4.0 or eMobility uses information technology to develop public transportation based on geographic information systems to increase the competitiveness of regional development. Also eCities or Cities 4.0, for analysis the city green space corridor is an urban park connector that connects green open spaces in every city. The passages are created by planting large

trees and potential green areas, such as pedestrians, river borders, the banks of water bodies and reservoirs, railroad borders, and can be used as motorized vehicle transportation and eco-friendly city tourism routes. Include in Sustainable Development, eDesa or Desa 4.0, is a concept of intelligent economy and tourism integration. It is part of the global master plan for sustainable development goals (SDGs), which integrates eDesa research products, innovative economy, and digital-based tourism to improve people's welfare.

The method for compiling the eDesa application will start from secondary data collection, data analysis, digital data compilation, eDesa geographic information technology preparation, innovative economy and tourism integration, MSMEs, and regional economy form of web GIS and mobile GIS (Android). Application is designed with a responsive mode to make it easier for users to access various mobile devices or computers that use different screen sizes. The main page for the application's graphical user interface (GUI), divided into several sections, including a header section and a content section. The eDesa application logo is found in the header section, and application menus are in the content section. The menu section itself is divided into two parts, namely, for icons and labels. The dashboard helps present information in graphical form of each available data. The data available is for the year 2020 for each type of data. There are also data on Regional GDP, APBD, and Bank Indonesia

## References

- [1] M. I. Setiawan *et al.*, "E-Business, Airport Development and Its Impact on the Increasing of Information of Communication Development in Indonesia," in *Journal of Physics: Conference Series*, 2018, vol. 1007, no. 1, doi: 10.1088/1742-6596/1007/1/012046.
- [2] M. I. Setiawan *et al.*, "E-Business, the impact of the Regional Government Development (APBD) on Information and Communication Development in Indonesia," in *Journal of Physics: Conference Series*, 2018, vol. 1007, no. 1, doi: 10.1088/1742-6596/1007/1/012045.
- [3] M. I. Setiawan *et al.*, "E-Business, the impact of regional growth on the improvement of Information and Communication Development," in *Journal of Physics: Conference Series*, 2018, vol. 1007, no. 1, doi: 10.1088/1742-6596/1007/1/012044.
- [4] A. Kaya and Ö. Aydin, "E-commerce in Turkey and sap integrated e-commerce system," *Int. J. Ebus. eGovernment Stud.*, vol. 11, no.

- 2, pp. 207–225, 2019, doi: 10.34111/ijepeg.20191128.
- [5] I. N. Sudapet, R. D. Nasihien, M. I. Setiawan, and C. Z. Zulkifli, “e-WISATA ANDROID APP DESIGNED FOR TOURISM, REGIONAL GDP, AND TAX OF REGIONAL GOVERNMENT BUDGET IN INDONESIA: THE CONTEXT OF INDUSTRIAL REVOLUTION 4.0,” *Int. J. Ebus. eGOVERNMENT Stud.*, vol. 13, no. 1, pp. 202–219, 2021, doi: 10.34109/ijepeg.202113110.
- [6] M. I. Setiawan, R. D. Nasihien, and M. I. M. Masirin, “Development Of Emobility Mobile App Based On Geographic Information Systems: Integrating Public Transportation, Regional Gdp, Regional Government Budget REVENUES AND EXPENDITURES (APBD) IN INDONESIA,” *Int. J. Ebus. eGOVERNMENT Stud.*, vol. 13, no. 1, pp. 220–238, 2021, doi: 10.34109/ijepeg.202113111.
- [7] M. Ikhsan Setiawan, A. Sukoco, D. Harmanto, P. Halim, A. Mursidi, and I.-H. Ting, “Sustainable Cities, Transportation and Warehousing GDP,” *IOP Conf. Ser. Earth Environ. Sci.*, vol. 498, p. 012112, Jun. 2020, doi: 10.1088/1755-1315/498/1/012112.
- [8] M. Kiba-Janiak, “EU cities’ potentials for formulation and implementation of sustainable urban freight transport strategic plans,” *Transp. Res. Procedia*, vol. 39, no. 2018, pp. 150–159, 2019, doi: 10.1016/j.trpro.2019.06.017.
- [9] A. Merino-Saum, P. Halla, V. Superti, A. Boesch, and C. R. Binder, “Indicators for urban sustainability: Key lessons from a systematic analysis of 67 measurement initiatives,” *Ecol. Indic.*, vol. 119, no. September, p. 106879, 2020, doi: 10.1016/j.ecolind.2020.106879.
- [10] M. Foltynski, “Sustainable Urban Logistics Plan - current situation of the city of Poznań,” *Transp. Res. Procedia*, vol. 39, no. 2018, pp. 42–53, 2019, doi: 10.1016/j.trpro.2019.06.006.
- [11] A. Sharifi, “Urban sustainability assessment: An overview and bibliometric analysis,” *Ecol. Indic.*, vol. 121, p. 107102, 2021, doi: 10.1016/j.ecolind.2020.107102.
- [12] P. Adolfsson, J. Lindblad, and S. Peacock, “Translations of sustainability in urban planning documents — A longitudinal study of comprehensive plans in three European cities,” *Cities*, vol. 119, no. August, p. 103360, 2021, doi: 10.1016/j.cities.2021.103360.
- [13] P. Gaubatz and D. Hanink, “Learning from Taiyuan: Chinese cities as urban sustainability laboratories,” *Geogr. Sustain.*, vol. 1, no. 2, pp. 118–126, 2020, doi: 10.1016/j.geosus.2020.06.004.
- [14] J. Awad and C. Jung, “Extracting the Planning Elements for

- Sustainable Urban Regeneration in Dubai with AHP (Analytic Hierarchy Process)," *Sustain. Cities Soc.*, vol. 76, p. 103496, 2022, doi: 10.1016/j.scs.2021.103496.
- [15] K. Soma, M. W. C. Dijkshoorn-Dekker, and N. B. P. Polman, "Stakeholder contributions through transitions towards urban sustainability," *Sustain. Cities Soc.*, vol. 37, no. October 2017, pp. 438–450, 2018, doi: 10.1016/j.scs.2017.10.003.
- [16] A. Buzási and B. S. Jäger, "District-scale assessment of urban sustainability," *Sustain. Cities Soc.*, vol. 62, no. July, p. 102388, 2020, doi: 10.1016/j.scs.2020.102388.
- [17] L. A. W. Fumagalli, D. A. Rezende, and T. A. Guimarães, "Challenges for public transportation: Consequences and possible alternatives for the Covid-19 pandemic through strategic digital city application," *J. Urban Manag.*, vol. 10, no. 2, pp. 97–109, 2021, doi: 10.1016/j.jum.2021.04.002.
- [18] X. Fang, X. Shi, T. K. Phillips, P. Du, and W. Gao, "The Coupling Coordinated Development of Urban Environment Towards Sustainable Urbanization: An Empirical Study of Shandong Peninsula, China," *Ecol. Indic.*, vol. 129, p. 107864, 2021, doi: 10.1016/j.ecolind.2021.107864.
- [19] V. M. Perra, A. Sdoukopoulos, and M. Pitsiava-Latinopoulou, "Evaluation of sustainable urban mobility in the city of Thessaloniki," *Transp. Res. Procedia*, vol. 24, no. 2016, pp. 329–336, 2017, doi: 10.1016/j.trpro.2017.05.103.
- [20] L. D. Vogel, L. Goertz, S. S. Shani, M. Boots, L. Dorval, and N. E. Wang, "A mobile-based healthcare utilization assessment in rural Ghana," *Procedia Eng.*, vol. 159, no. June, pp. 366–368, 2016, doi: 10.1016/j.proeng.2016.08.394.
- [21] Z. Ni, B. Wu, C. Samples, and R. J. Shaw, "Mobile technology for health care in rural China," *Int. J. Nurs. Sci.*, vol. 1, no. 3, pp. 323–324, 2014, doi: 10.1016/j.ijnss.2014.07.003.
- [22] C. PENG, B. MA, and C. ZHANG, "Poverty alleviation through e-commerce: Village involvement and demonstration policies in rural China," *J. Integr. Agric.*, vol. 20, no. 4, pp. 998–1011, 2021, doi: 10.1016/S2095-3119(20)63422-0.
- [23] S. T. Holden and M. Tilahun, "Mobile phones, leadership and gender in rural business groups," *World Dev. Perspect.*, vol. 24, p. 100370, 2021, doi: 10.1016/j.wdp.2021.100370.
- [24] L. Knierim and J. C. Schlüter, "The attitude of potentially less mobile people towards demand responsive transport in a rural area in central Germany," *J. Transp. Geogr.*, vol. 96, no. October, p.

- 103202, 2021, doi: 10.1016/j.jtrangeo.2021.103202.
- [25] L. Philip, C. Cottrill, J. Farrington, F. Williams, and F. Ashmore, "The digital divide: Patterns, policy and scenarios for connecting the 'final few' in rural communities across Great Britain," *J. Rural Stud.*, vol. 54, pp. 386–398, 2017, doi: 10.1016/j.jrurstud.2016.12.002.
- [26] M. I. Setiawan, R. D. Nasihien, and M. A. B. M. Razi, "Sustainable mobility, development of integrated public transportation technology 4.0 gis supports regional development," *Proc. Int. Conf. Ind. Eng. Oper. Manag.*, vol. 2, no. August, pp. 3919–3926, 2020.
- [27] M. A. B. M. Setiawan, M.I., Nasihien, R.D., Razi, "Sustainable mobility, development of integrated public transportation technology 4.0 gis supports regional development," *Proc. Int. Conf. Ind. Eng. Oper. Manag. Detroit, Michigan, USA*, pp. 3919–3926, 2020.
- [28] M. Ikhsan Setiawan, R. Durrotun Nasihien, M. A. Mohammad Razi, and I.-H. Ting, "Sustainable Mobility, Maritime, Airport, and Regional Government Revenue and Expenditure (APBD)," in *IOP Conference Series: Earth and Environmental Science*, Jun. 2020, vol. 498, p. 012111, doi: 10.1088/1755-1315/498/1/012111.
- [29] M. I. Setiawan, M. A. Bin Mohammad Razi, R. D. Nasihien, and A. T. Bon, "Sustainable mobility and transportation research in Indonesia," *Proc. Int. Conf. Ind. Eng. Oper. Manag.*, vol. 2, no. November, pp. 723–730, 2019.
- [30] M. I. Setiawan, M. A. B. Mohammad Razi, R. D. Nasihien, and A. T. Bon, "Sustainable mobility and transportation research in Indonesia," in *Proceedings of the International Conference on Industrial Engineering and Operations Management*, 2019, no. November.
- [31] M. I. Setiawan, R. D. Nasihien, M. Adib, M. Razi, and A. Rosyid, "Covid19 , Sustainable Mobility and Transportation Research," *IJEBD Int. J. Entrep. Bus. Dev.*, vol. 04, no. 01, pp. 123–130, 2021.
- [32] I Nyoman Sudapet, R. Durrotun Nasihien, M. Haziman Wan Ibrahim, M. Ikhsan Setiawan, A. Sukoco, and A. Rosyid, "COVID-19 and World Tourism Research," *IJEBD Int. J. Entrep. Bus. Dev.*, vol. 04, no. 02, pp. 211–215, 2021.
- [33] I. N. Sudapet, A. Sukoco, M. I. Setiawan, and A. T. Bon, "Tourism, maritime research in the world and its impact in Indonesia," in *Proceedings of the International Conference on Industrial Engineering and Operations Management*, 2019, no. November.



- [34] I. N. Sudapet, R. Durrotun Nasihien, M. H. Wan Ibrahim, M. Ikhsan Setiawan, C. Lin, and S. Wiwoho Mudjanarko, "Tourism, Accommodations, Food Services, and Regional GDP," in *IOP Conference Series: Earth and Environmental Science*, 2020, vol. 498, no. 1, doi: 10.1088/1755-1315/498/1/012110.
- [35] I. N. Sudapet, A. Sukoco, M. H. bin Wan Ibrahim, M. I. Setiawan, and A. T. Bon, "Indonesia research in tourism and digital tourism," in *Proceedings of the International Conference on Industrial Engineering and Operations Management*, 2019, no. November.
- [36] I. N. Sudapet, A. Sukoco, M. H. B. W. Ibrahim, and M. I. Setiawan, "Exploring mediating role of supply chain management between logistic management, supplier selection and planning of supply chain and sustainability, supported tourism business in Indonesia," *Int. J. Supply Chain Manag.*, vol. 8, no. 6, 2019.
- [37] I. N. Sudapet, R. D. Nasihien, M. H. B. W. Ibrahim, A. Sukoco, and M. I. Setiawan, "Tourism 4.0, digital-based tourism to improve the welfare of people in east java," *Proc. Int. Conf. Ind. Eng. Oper. Manag.*, vol. 2, no. August, pp. 3927–3933, 2020.
- [38] M. I. Setiawan *et al.*, "Indonesia airport, passanger and aircraft impact on regional budget (APBD)," in *Proceedings of the International Conference on Industrial Engineering and Operations Management*, 2019, vol. 1, no. MAR, pp. 1752–1753, [Online]. Available: <https://www.scopus.com/inward/record.uri?eid=2-s2.0-85067235786&partnerID=40&md5=5b345595b49130ff73bbea0a0334b8f6>.
- [39] N. Sudapet *et al.*, "Small and medium enterprises, Central Business District (CBD) for accelerating of regional development," *Int. J. Eng. Technol.*, vol. 7, no. 3.6 Special Issue 6, 2018.
- [40] M. I. Setiawan *et al.*, "Indonesia airport, passanger and aircraft impact on regional budget (APBD)," in *Proceedings of the International Conference on Industrial Engineering and Operations Management*, 2019, vol. 1, no. MAR.

# Management of Science Learning in the Era of Society 5.0 in Indonesia

Muhammad Minan Chusni<sup>90</sup>

## Introduction

The changing world is now entering the era of the society revolution 5.0. The concept of Industrial 4.0 and Society 5.0 resolutions actually does not have much difference, but the Society concept focuses more on the context of humans. If the industrial revolution uses AI, and artificial intelligence as its main component, while Society 5.0 uses modern technology, it only relies on humans as its main component [1]. Preparing graduates who are qualified and able to compete globally, and master technological developments are important for everyone and important for the future of a country [2]. Thus, the support and role of education is expected to increase the competitiveness of the Indonesian nation in the midst of global competition with the rapid development of information technology.

In Society 5.0 where the main component is humans who are able to create new value through technological developments, it can minimize the gap between humans and economic problems in the future. It seems difficult to do in a developing country like Indonesia, but that doesn't mean it can't be done because currently Japan has proven it as a country with the most advanced technology.

Referring to the view of Staron states "Life-based learning proposes that learning for work is not restricted to learning at work" [3]. However, Staron's statement is not sufficient for Indonesia's condition. For the people of Indonesia, learning to work is only part of the necessities of life. There are still many other needs that must be met, such as the need to socialize, worship according to religion, protect the environment, maintain local wisdom traditions, have community-nation, and state [4]. The emphasis of life-based learning is the development of knowledge to contribute to the welfare and happiness of society in a balanced and harmonious manner, so that it becomes a reliable human resource. This expression is in line with [5] which states that in an effort to face the era of global competition, Indonesia also needs to prepare reliable human resources in STEM

---

<sup>90</sup> UIN Sunan Gunung Djati Bandung

disciplines in quality and sufficient quantity. Based on the description above, this paper will explore the implementation and management of science learning in Indonesia in the society 5.0 era.

## **Discussion**

### **Education in 5.0 era**

Education in the era of society 5.0 needs to be seen as the development of 21st century competencies, which consists of three major components, namely the competence to think, act, and live in the world [6]. Thinking components include critical thinking, creative thinking, and problem solving. Action components include communication, collaboration, digital literacy, and technological literacy. The components of living in the world include initiative, self-direction, global understanding, and social responsibility.

Educational praxis in schools that relies on the mode of transmitting knowledge from teachers to students may be successful in the industry 1.0 era, but is now no longer effective in preparing the younger generation to enter a society 5.0 ecosystem that prioritizes 21st Century competency development. Education 5.0 can only be implemented by referring to the new paradigm of education characterized by students as connectors, creators, and constructivists in the context of the production and application of knowledge and innovation. [7]. The synthesis of views on the characteristics of Education 5.0 leads to several learning features, namely: 1) Learner-centered learning, providing opportunities for students to learn according to their respective interests and learning speed; 2) Learning develops the ability of students to explore their own knowledge from information sources by using the internet, as a vehicle for them to learn for life; 3) Utilization of ICT infrastructure and virtual learning tools to provide flexibility for students to find quality learning resources, record data, analyze data, and prepare reports and make presentations; 4) Emphasizing hands-on learning through the “flipped classroom” learning method, in which students learn theoretical aspects of knowledge at home and practice in class; 5) Develop soft-skills of critical thinking, creativity, and problem solving, especially authentic and non-routine problem solving; 6) Collaboration and in social interaction as the main approach used in competency development, to introduce work culture in industry and the world of work in the 21st Century; 7) Provide flexibility for the learning process in the form of blended learning, which allows

students to interact, collaborate and learn from each other in classroom settings or remotely via the internet.

### **The Future of Indonesian Education in Era 5.0**

The challenges of industrial revolution 5.0 are as follows: 1) information technology security issues; 2) reliability and stability of production machines; 3) lack of adequate skills; 4) reluctance to change by stakeholders; and 5) loss of a lot of work due to turning to automation [8]. These challenges must be answered quickly and accurately so as not to contribute to an increase in unemployment. The government seeks to respond to the challenges of industry 5.0, the threat of unemployment, and the demographic bonus with a focus on improving the quality of human resources through education. The government through cross-ministerial and institutional policies issued various policies. One of the government's policies is the revitalization of Indonesian education. Support from the government must include, 1) learning systems, 2) education units, 3) students, and 4) educators and education staff are also needed.

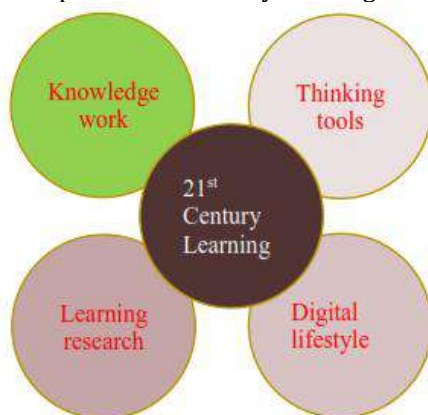
The revitalization of the learning system includes, 1) curriculum and character education, 2) information and communication technology-based learning materials, 3) entrepreneurship, 4) alignment, and 5) evaluation. Educational units include, 1) new school units and new classrooms, 2) other study rooms, 3) classroom rehabilitation, 4) student and teacher dormitories, 5) equipment, and 6) school management and culture. Elements of students include, 1) awarding scholarships and 2) developing talents and interests. Elements of educators and education personnel include, 1) provision, 2) distribution, 3) qualifications, 4) certification, 5) training, 6) career and welfare, and 7) rewards and protection.

Strengthening the four elements that exist in the education system requires a new movement to respond to the industrial era 5.0. One of the movements launched by the government is the new literacy movement as a reinforcement and even shifting the old literacy movement. The intended new literacy movement focuses on three main literacies, namely, 1) digital literacy, 2) technological literacy, and 3) human literacy [9]. These three skills are predicted to be skills that are needed in the future or in the era of society 5.0.

Digital literacy is aimed at improving the ability to read, analyze, and use information in the digital world (Big Data),

technological literacy is aimed at providing an understanding of how machines work and technology applications, and human literacy is directed at improving communication skills and mastery of design science [9]. The new literacy provided is expected to create competitive graduates by perfecting the old literacy movement which only focuses on improving reading, writing, and math skills.

The adaptation of the new literacy movement can be integrated by adjusting the curriculum and learning system in response to the era of society 5.0. The educational response that needs to be developed is 21st century learning.



**Figure 1. 21st Century Learning Orientation**

Figure 1 shows 21st century learning oriented towards digital lifestyles, thinking tools, learning research and how knowledge works. Three of the four orientations of 21st century learning is very close to science learning, namely how knowledge works, strengthening thinking tools, and research. The way knowledge works is the ability to collaborate in teams with different locations and with different tools, strengthening thinking tools is the ability to use technology, digital tools, and services, and research is the ability to conduct investigations and discoveries [10].

All forms of skills and skills needed in the 21st century and the era of society 5.0 must be integrated into the elements of education. Starting from the learning system, education units, students, to educators and education staff. The content of 21st century learning must always adapt to changes, including in the era of society 5.0. The learning content is expected to be able to fulfill 21st century skills, namely; 1) learning and innovation skills include mastery of diverse knowledge and skills, learning and innovation,

critical thinking and problem solving, communication and collaboration, and creativity and innovation, 2) digital literacy skills including information literacy, media literacy, and ICT literacy, 3) career and life skills including flexibility and adaptability, initiative, social and cultural interaction, productivity and accountability, and leadership and responsibility [10].

### **Teaching STEM-based Science**

One of the characteristics of STEM education is that it integrates science, technology, engineering, and mathematics in solving real problems. However, there are a variety of methods used in practice to integrate STEM disciplines, and the pattern and degree of cohesion depends on many factors [11]. If science, technology, engineering, and mathematics are taught as four separate and non-integrated subjects (referred to as “silos”), this situation is more accurately described as S-T-E-M rather than STEM. [12]. The second way is to teach each of the STEM disciplines by focusing more on one or two of the STEM disciplines. The third way is to integrate one into the three STEM disciplines, for example engineering content is integrated into science, technology, and mathematics subjects. A more comprehensive way is to fuse the four STEM disciplines and teach them as integrated subjects, such as technology, engineering and math content in science, so that science teachers integrate T, E, and M into S.

In the context of general primary and secondary education in many countries, including Indonesia, only science and mathematics subjects are part of the conventional curriculum, while technology and engineering subjects are only a minor part or even absent in the curriculum. Therefore, STEM education is more focused on science and mathematics. In this regard, Bybee conceptualized a continuum of STEM integration consisting of nine patterns of cohesiveness, ranging from the S-T-E-M discipline as a “silo” (a stand-alone subject) to STEM as a transdisciplinary subject [13]. Deeper integration into the form of transdisciplinary subjects requires a comprehensive restructuring of the curriculum, making it relatively difficult to implement in the context of the conventional curriculum structure in Indonesia. One pattern of integration that may be implemented without restructuring the primary and secondary education curriculum in Indonesia is to incorporate engineering, technology, and mathematics content in STEM-based science learning.

The pattern of full integration is relatively easier to do at the elementary school level, when students are taught by a class teacher. Meanwhile, the form of "embedded STEM" is more appropriate at the high school level. STEM education manifests in certain situations when learning science or mathematics involves authentic problem-solving activities in social, cultural, and functional contexts [11]. Science and mathematics are considered appropriate to be vehicles for bringing STEM Education, because these two subjects are the main subjects in primary and secondary education, and become the basis for students to enter careers in STEM disciplines, which are seen as fundamental to technological innovation and economic productivity.

STEM-based science learning demands a shift in the mode of the learning process from conventional teacher-centered (teacher centered) modes that rely on knowledge transfer towards student centered learning modes that rely on student activity, hands-on, and collaboration. STEM-based science learning needs to be implemented in problem-based learning units, in which students are challenged critically, creatively, and innovatively to solve real problems, which involve collaborative group (team) activities. STEM-based science learning in the classroom is designed to provide opportunities for students to apply academic knowledge in the real world

## **Conclusion**

Various challenges emerged from the emergence of the society 5.0 revolution, including from the economic, social, technical, environmental, political and legal fields. For Indonesia, the problem of unemployment and the competitiveness of human resources is a real challenge. However, there is also a potential opportunity for a demographic bonus in 2030-2040, namely the population of productive age is more than that of the non-productive population. Therefore, the large population of productive age must be followed by quality improvements, both in terms of education, skills, and the ability to compete in the labor market. The educational response that needs to be developed is 21st century learning, with learning content that must always adapt to changes, including in the industrial era 4.0, namely; 1) learning and innovation skills, 2) digital literacy skills, and 3) career skills and life skills. One alternative is the STEM (Science, Technology, Engineering, and Mathematics) approach.

## References

- [1] Kemenristekdikti, "Pengembangan Iptek dan Pendidikan Tinggi di Era Revolusi Industri 4.0," *Kementerian Riset, Teknologi, Dan Pendidikan Tinggi Republik Indonesia*, 2018. <https://www.ristekdikti.go.id/siaran-pers/pengembangan-iptek-dan-pendidikan-tinggi-di-era-revolusi-industri-4-0/> (accessed Apr. 20, 2019).
- [2] H. Kanematsu and D. M. Barry, *STEM and ICT education in intelligent environments*. Springer, 2016.
- [3] M. Staron, "Life-based learning model—a model for strength-based approaches to capability development and implications for personal development planning," *Aust. Gov. Dep. Educ. Sci. Train. TAFE NSW Available on-line <http://learningtobeprofessional.pbworks.com/w/page/32893040/Life-based-learning>* Accessed, vol. 21, no. 12, p. 2014, 2011.
- [4] P. Sudira, *Pengembangan model "Lis-5c" pada pendidikan teknologi dan kejuruan*. Yogyakarta State University, 2015.
- [5] H. Firman, "Pendidikan sains berbasis STEM: Konsep, pengembangan, dan peranan riset pascasarjana," 2015.
- [6] L. M. Greenstein, *Assessing 21st century skills: A guide to evaluating mastery and authentic learning*. Corwin Press, 2012.
- [7] G. Brown-Martin, "Education and the fourth industrial revolution," *Retrieved from Learn. {Re} imagined <https://medium.com/learning-re-imagined/education-and-the-fourth-industrial-revolution-cd6bcd7256a3>*, 2017.
- [8] F. Hecklau, M. Galeitzke, S. Flachs, and H. Kohl, "Holistic approach for human resource management in Industry 4.0," *Procedia Cirp*, vol. 54, pp. 1–6, 2016.
- [9] J. E. Aoun, *Robot-proof: higher education in the age of artificial intelligence*. MIT Press, 2017.
- [10] B. Trilling and C. Fadel, *21st Century Skills: Learning for Life in Our Times*. San Francisco: Jossey-Bass, 2009.
- [11] A. Roberts, "A justification for STEM education," *Technol. Eng. Teach.*, vol. 71, no. 8, pp. 1–4, 2012.
- [12] W. E. Dugger, "Evolution of STEM in the United States," 2010.
- [13] R. W. Bybee, *The case for STEM education: Challenges and opportunities*. NSTA press, 2013.



# **Culture Freedom to Learn Based on the Philosophy of the Indonesian Nation in Entrepreneurship Courses in the Era of Society 5.0**

Nanis Hairunisya

## **Introduction**

The existence of different cultures and habits from students is a challenge and opportunity for educators in the Merdeka Learning Campus Merdeka (MBKM) program.[1] The different culture of each student, ranging from belief in God Almighty, regional and ethnic origin, habits, daily lifestyles and associations, must be a concern for lecturers in applying learning methods and determining learning outcomes. How an educator embodies the values of the five Pancasila precepts [2] as the philosophy of the Indonesian Nation in the MKBM class, that is where it will be seen how Pancasila is present in preparing university graduates to become a superior generation, responsive to challenges without being uprooted from the cultural roots of the Indonesian nation.

Universities as a source of inspiration and agents of change are in a strategic position in dealing with the consequences of the industrial revolution 4.0 and the emergence of a new concept, namely society 5.0 from Japan. In this era of society 5.0, the competence of lecturers is not only to use the internet of things, but rather plays a role in how big data obtained from the internet can be used and utilized according to the needs and real conditions in the classroom. This means that the role of a lecturer in the era of society 5.0 fills gaps and overcomes cultural differences in the classroom by selecting, sorting out the learning resources needed by students. The role of lecturers in the era of society 5.0 is increasingly strategic in creating a superior generation, because lecturers must be able to harmonize the demands of student literacy skills with student behavior/character that reflects the profile of Indonesian students. The same thing was conveyed by [3] related to the concept of society 5.0 which requires a smart strategy, especially for universities.

The presence of an independent campus or independent learning in the 4.0 era is a challenge for universities to prepare a 5.0 society. The Independent Campus concept in providing work experience to students is basically an experiential learning approach to support the achievement of learning outcomes. Students still don't

really understand and know the Merdeka Campus experiential learning program. So, some actions related to knowledge and awareness sharing should be taken.[4]. Various studies have been carried out on the theme of society 5.0. [5] recommends that policy makers in the fields of government, education and industry should consider the elements of society 5.0 in conducting open research, especially because of the different culture with Japan as the originator of Society 5.0. [6] [7].

Changes in all aspects of life are due to technological innovations that are growing rapidly so that the concept of society 5.0 appears to anticipate it. This is one of the Japanese government's efforts in dealing with global trends that arise due to the sector and society. The presence of the community 5.0 will be able to solve social problems through an integrated global system of virtual and real space. Especially in the world of education, students must have high-level thinking skills, such as the ability to solve problems, think critically, and creatively.[8] Various methods that involve technology have been carried out in an effort to prepare society 5.0, including findings [9] showing the benefits felt by students after implementing gamification in the campus independent learning system. The presence of gamification can provide more motivation to participate in independent Campus activities and enthusiasm in completing tasks.

[10] found a link between Society 5.0 and the role of digital literacy and the COVID-19 pandemic, contributing to the promotion and acceleration of the digitalization process. Teachers and lecturers from all levels of education who are forced by physical distancing conditions and the prohibition of face-to-face learning, in order to immediately achieve digital competence and develop competencies that allow the success of the online teaching and learning process [11][12]

[13] stated that education in Indonesia in welcoming the era of society 5.0 was prepared by looking at the existing infrastructure in Indonesia, human resource development, synchronizing education and industry and the use of technology as a tool for teaching and learning activities. There are four things that make universities produce quality graduates, namely competency-based education, the use of IoT (Internet of Things), the use of virtual or augmented reality and the last is the use of AI (Artificial Intelligence). [14] The concept of independent learning campus self-study is presented to improve the education system in Indonesia.

However, [15] found the industrialization of education in the MBKM policy launched by the Ministry of Education and Culture. This can be seen in the indicators of the success of an educational institution is the acceptance of students in an industry and a short waiting period to get a job. The existence of this indicator shows that the design of education with MBKM is more focused on creating students to become skilled workers according to the demands of the business world and industry. This can be interpreted that the focus of education design prioritizes hard skills rather than soft skills, which in the end will be inversely proportional to the national education goals in Bill 20 of 2003 [16], namely shaping character and personality as a priority. Therefore, the Free Learning Culture that is written in MBKM has opportunities and challenges for lecturers and higher education management

The existence of the implementation of MBKM which leaves a question between balancing hard skills as the focus of MBKM and soft skills as the goal of Pancasila-based national education results juxtaposed with the concept of society 5.0 which requires educators to coexist with intelligent technology, leaving many questions to the author, especially preparing lecturers' competence in manage entrepreneurship learning in the classroom in the future. Entrepreneurship course is a course that trains students to be sensitive to see opportunities both in the business world and in the perspective of other fields of science. In entrepreneurship courses, students are equipped with creative and innovative characters, both in the form of soft skills and hard skills.[17]

Along with the MKBM policy, the role of lecturers in learning is more emphasized on mediators, catalysts and policy makers in deciding which learning resources and learning media can be used by students and what learning models can be done by students. The results of the study [11] also stated that educators have an important role in the post-pandemic world. Educators must be prepared to play a central role in helping nurture digital citizens who can engage ethically to create a more just world. How do lecturers have to improve their competence in welcoming the era of society 5.0 to prepare entrepreneurial students so that a free culture of learning is in line with the Pancasila philosophy?

## **Discussion**

### **Culture Freedom to Learn**

Changes in habits (culture) after the COVID-19 pandemic are a challenge for Indonesian education, which must also prepare students to adapt to the challenges of the Society 5.0 era. The success of online learning is highly dependent on several integrated components, such as students, educators, learning resources, and the technology used. The ability to master MS office software and students' online learning technology as an indicator of a culture of independent learning greatly influences student learning outcomes. Some of the weaknesses of online learning, such as student discipline, lack of internet access, and lack of social interaction, which are indicators in changing the culture of independent learning are common challenges for education management and stakeholders.

The implementation of MBKM has an impact on student study habits. The MBKM program is a milestone in the freedom of student learning. The learning culture that was originally set to follow the courses prepared by the curriculum of the study program became a free culture of learning in choosing subjects that students were interested in according to their talents and interests. Of course, change brings both positive and negative impacts. This change in learning culture will be positive if students know for sure what they are interested in and become an obsession in achieving their goals. However, it will have a negative impact if students do not know the talents and interests they want to pursue, so they only join friends in choosing courses outside their study program.

### **Era Society 5.0**

In the era of Society 5.0 digitalization, virtual and online have become a new culture in accordance with individual expectations now and in the future. This concept allows the development of various analyzes of the process of forming a digital cultured society to carry out sustainable social and economic development. The results make it possible to conclude that, although the concept of Society 5.0 initially had a Japanese national dimension, it is likely, with modifications taking into account the different features of several countries, to be applied by regions of the world seeking future sustainable development.

Society 4.0 and society 5.0 will have a significant dual effect on the education system, in terms of content, methodology and learning models. The main problem that will occur is a shift in values,

models and technological procedures that occur in an extreme and fundamental way. The Industrial Revolution 4.0 developed an internet-based system (IoT) model with various infrastructure approaches, both hardware and software. Japan is addressing the implementation of the high-level 4.0 revolution by developing the 5.0 community model system (Society 5.0). This model leaves most of the system management in artificial intelligence independently in carrying out extensive execution of various life problems. This condition certainly brings new wisdom in the process of cultural transformation of the interface between humans and intelligent machines. Technology and vocational education will be in direct contact with two significant paradigms related to the concept of substance, application, and culture.

Welcoming the condition of society 5.0 as a lecturer in entrepreneurship courses, it is necessary to prepare innovative creative learning methods based on information technology. Improving students' digital knowledge and skills in finding learning references, mastering gadgets, IoT, bolt-on intelligence, big data, augmented reality and virtual reality.

There are several things to note that the increasing role of information and information technology has led to a new stage in the development of modern society. The global information space provides effective human interaction in meeting the needs of goods and services through online shopping. Global informatization and modern events are changing the way consumers think and understand information. This condition must be considered in changing the learning strategy towards society 5.0.

### **Student Success in Entrepreneurship**

The culmination of all the efforts of educators, the academic community and policy makers is the achievement or success of students after completing their education. Even in entrepreneurship courses, the success of these students can be seen during the entrepreneurship internship process. Entrepreneurial students have creative, innovative, unyielding characters, dare to start and take risks, always have the initiative in every condition, tend to be leaders and like to work together. The existence of this MKBM policy really supports the success of entrepreneurship students because with this MKBM students can feel a different experience when they are in other universities. Expanding experience with different cultures will also be a motivating factor for students to organize themselves,

strengthening their own character for the success of their business in the future.

The existence of an independent culture of learning is a driving force for the success of students taking entrepreneurship courses when the era of society 5.0 has actually been implemented. For this reason, from now on, lecturers must have prepared themselves to increase competence in the field of digital literacy and perhaps also robotic science so that they can lead students to success after graduating from college. As educators, we must be present to strengthen the character of these students with the values of Pancasila.

The same thing was conveyed by Rusdiana that an entrepreneur is a businessman who in addition to being able to do business in the economic and commercial fields in an effective manner (appropriate and useful, effective, and efficient), also has an independent character and is spiritual and virtuous. The ideal picture of an entrepreneur is a person who in an emergency is still able to stand on his own abilities to help himself out of the difficulties he faces, including overcoming poverty without the help of government agencies or social institutions. Under normal conditions, entrepreneurs are even able to make themselves advanced, rich, successful physically and mentally.

Entrepreneurs must have the determination and ability to read the opportunities of a phenomenon and create innovative and creative products. Future young entrepreneurs will definitely experience challenges and opportunities in terms of product marketing strategies, business idea development, and also consistency in running a business.

One of the strategies to realize society 5.0 in the field of entrepreneurship education is that lecturers must continue to improve pedagogic competence in utilizing high-level technology. Lecturers must be able to make students active with project base learning methods, contextual learning and easy to understand learning materials with the help of technology. In addition, the skills of making technology-based learning media must continue to be developed. Lecturers must be able to master the 21st century learning process which includes Technological Pedagogic Content Knowledge (TPACK). Information and communication technology is a tool in achieving a learning process that prioritizes 21st century skills that must be possessed by students. .

The main effort in preparing education in the era of Society 5.0 is to improve the competence of lecturers. The shift in learning culture must be anticipated in order to avoid culture shock. In order to minimize this learning culture shock, from the start, we must use the Pancasila philosophy in a new learning culture in mastering digital learning technology. Of course, the preparation for society 5.0 must be supported by all parties, namely the government, society, parents, the industrial world.

The skills that must be possessed in entrepreneurship learning towards society 5.0 are (1) learning and innovation skills; (2) proficiency in information, media and technology; (3) life and career skills. Some of the skills that are part of learning and innovation skills are: (a) creativity and innovation; (b) critical thinking and problem solving; (c) communication and collaboration. The information skills include: (a) Information literacy; (b) media literacy; (c). ICT (Information, Communications and Technology) literacy. For life and career skills include: (a) Flexibility and Adaptability; (b). Initiative and independence; (c) cross-cultural skills; (d) Productivity and accountability and (e) leadership and responsibility.

## **Conclusion**

Some of the efforts that must be made by lecturers as educators in facing society 5.0 with an independent culture of learning in the first entrepreneurship course are to be based on the Pancasila philosophy. Furthermore, lecturers must improve their competence in preparing society 5.0 with the concept of 21st century learning. Lecturers must be able to master the 21st century learning process which includes Technological Pedagogic Content Knowledge (TPACK). The skills that must be possessed in entrepreneurship learning towards society 5.0 are (1) learning and innovation skills; (2) proficiency in information, media and technology; (3) life and career skills. To prepare for society 5.0, there must be cooperation with all parties, including the government, community, family and industry.

## **References**

- [1] M. Pendidikan, D. A. N. Kebudayaan, and R. Indonesia, "Peraturan Menteri Pendidikan Dan Kebudayaan Republik Indonesia Nomor 3 Tahun 2020 Tentang Standar Nasional Pendidikan Tinggi." 2020.
- [2] D. Panitia Lima, Mohammad hatta, "Uraian Pancasila Dilengkapi

- dengan Dokumen Lahirnya Pancasila." Mutiara Jakarta, 1984.
- [3] M. S. Sarif, "Society 5.0 Qalb With Tawhidic Paradigm," *J. Educ. Soc. Sci.*, vol. 8, no. 1, pp. 208–217, 2017.
  - [4] Y. Suharyanti, L. A. Rudwiarti, P. Mudjihartono, and A. J. Wibowo, "Student's Preferences and Perceptions on Kampus Merdeka Experiential Learning Programs," 2021, doi: 10.2991/assehr.k.210202.076.
  - [5] M. E. Gladden, "Who Will Be the Members of Society 5.0? Towards an Anthropology of Technologically Posthumanized Future Societies," *Soc. Sci.*, vol. 8, no. 5, p. 148, May 2019, doi: 10.3390/socsci8050148.
  - [6] K. Fukuda, "Science, technology and innovation ecosystem transformation toward society 5.0," *Int. J. Prod. Econ.*, vol. 220, p. 107460, Feb. 2020, doi: 10.1016/j.ijpe.2019.07.033.
  - [7] M. J. Sá, A. I. Santos, S. Serpa, and C. M. Ferreira, "Digital Literacy in Digital Society 5.0: Some Challenges," *Acad. J. Interdiscip. Stud.*, vol. 10, no. 2, p. 1, Mar. 2021, doi: 10.36941/ajis-2021-0033.
  - [8] P. Mytra, W. Wardawaty, A. Akmal, K. Kusnadi, and R. Rahmatullah, "Society 5.0 in Education: Higher Order Thinking Skills," 2021, doi: 10.4108/eai.18-11-2020.2311812.
  - [9] Q. Aini, M. Budiarto, P. O. H. Putra, and N. P. L. Santoso, "Gamification-based The Kampus Merdeka Learning in 4.0 era," *IJCCS (Indonesian J. Comput. Cybern. Syst.)*, vol. 15, no. 1, 2021, doi: 10.22146/ijccs.59023.
  - [10] A. Androniceanu, "Innovative Digital Models for an Intelligent and Sustainable Education," in *Encyclopedia of Educational Innovation*, 2020.
  - [11] B. A. Buchholz, J. DeHart, and G. Moorman, "Digital Citizenship During a Global Pandemic: Moving Beyond Digital Literacy," *J. Adolesc. Adult Lit.*, vol. 64, no. 1, pp. 11–17, Jul. 2020, doi: 10.1002/jaal.1076.
  - [12] H. Jormand, S. Bashirian, M. Barati, S. Khazaei, E. Jenabi, and S. Zareian, "A Qualitative Study On People's Experiences Of Covid-19 Media Literacy," *MEDIA Lit. Acad. Res.*, 2021.
  - [13] F. Nastiti and A. Abdu, "Kajian: Kesiapan Pendidikan Indonesia Menghadapi Era Society 5.0," *Edcomtech J. Kaji. Teknol. Pendidik.*, vol. 5, no. 1, pp. 61–66, Apr. 2020, doi: 10.17977/um039v5i12020p061.
  - [14] D. N. Saputra, "New Curriculum: The Concept of Freedom Learning In Music Learning in Department of Music Education," 2020, doi: 10.31098/ictase.v1i1.15.



- [15] D. Kodrat, "Industrial Mindset of Education in Merdeka Belajar Kampus Merdeka (MBKM) Policy," *J. Kaji. Perad. Islam*, vol. 4, no. 1, pp. 9–14, Apr. 2021, doi: 10.47076/jkpi.v4i1.60.
- [16] P. R. Indonesia, "Undang-Undang Republik Indonesia Nomor 20 TAHUN 2003 Tentang Tentang Sistem Pendidikan Nasional," 2013.
- [17] Rusdiana, *Kewirausahaan Teori Dan Praktik*. CV Pustaka Setia., 2018.

# Development of Children's Basic Movement Skills

Nevi Hardika

## Introduction

For lovers of physical education, the terms locomotor, nonlocomotor and manipulative motion are no longer new. The three basic movement patterns above we have often heard and memorized by heart. In lectures the author often says "too much" for physical education students who do not know and have never heard of the terms locomotor, non-locomotor and manipulative. Again "really too".

Research results from, [1] The occurrence of improvement Increasing motor skills competency and increasing physical fitness are the desired learning outcomes for Therefore related to health it can be proven that there is a relationship between the level of competence of manipulative skills and physical fitness between boys and girls in primary school age children.

Explanation of the results of the study, [2] by carrying out the Lunastix Task which is considered a learning activity because it is gender neutral, fundamental object manipulation skills can show clearly that there is a relationship between the conception of children's abilities related to their beliefs about effectiveness in sports efforts in the fundamental domain skills for success in sports skills.

While the research findings according to, [3] Motor skills competency is a factor that enables it to provide the physical foundation needed for the enjoyment and success of physical activity involvement in children's motor skill competencies must be developed naturally as a result of physical growth based on dynamic interactions between tasks, students, and the environment and the development of motor skills must be learned and practiced in a structured learning environment based on the sequence of children's motor development and highly dependent on the teacher providing quality physical education.

[4] Explain that; Movement learning is a series of processes associated with practice or experience that lead to relatively permanent changes in a person's ability to perform skilled movements.

Whereas, [5] Motor learning is a relatively permanent process of changing movement behavior as a result of practice and experience. [6] also argues that motor learning is a process of increasing a motor skill caused by training conditions or obtained from experience, not due to maturation conditions or temporary motivation and

physiological fluctuations. While the research findings according to, [7]; The development of fundamental motor skills (fundamental motor skill) is very important for early childhood because the pattern of gestational pregnancy at an early age has involved large muscle groups and smooth muscles and motor skills are generally separated into locomotor, object control, and stability skills.

From the description above, it can be concluded that Learning motion is a series of relatively permanent changes in motion behavior involving smooth and large muscles obtained from experience and practice to display skilled and correct movements that must be applied to early childhood. [8] Basically the achievement of learning motion is influenced by several factors, namely: (1) Understand what to learn, (2) opportunity to respond, (3) There is feedback, and (4) Reinforcement between feedback. The definition of learning to move in the form of a definition put forward by several experts, among others, is as follows:

[9] defines: Learning motion is a process of behavioral adaptation with regard to movement and muscular response. [9] defines: Learning motion is a series of processes associated with practice or experience that lead to relatively permanent changes in the ability to respond. [10] defines: Learning to move is a process by which a person develops the ability to perform a task, through a combination of physical and psychological factors.

From these 3 definitions, it can be concluded that a comprehensive definition is: Learning to move is a relatively permanent process of adapting movement behavior and muscular responses, as a result of efforts to develop the ability to perform tasks through practice and experience that involves integrated physical and psychological factors. Basic Movement Skills are repetitive movements that are carried out continuously from habits and make them the basis of their environmental experience. The development of basic movements is a process to obtain motion that is constantly evolving based on: (1) the process of developing nerves and muscles which are also influenced by heredity, (2) the result of previous motion experiences, (3) current motion experiences, (4) movements described in relation to certain movement patterns. At the time before elementary school age, humans can control gross movements and after elementary school age there is a significant development in controlling better coordination and involving smaller muscles or what is called fine motion. In general, the basic human movement is walking, running, jumping and throwing.

## **Discussion**

Argued that the process of learning motion skills occurs in 3 phases of learning, namely: (1) Cognitive stage, For the first time, students are introduced to new movement skills, and the main task of students is to understand and understand the stages and requirements for doing the movement [11]. Student in cognitive stage this may have a lot of questions. (2) Associative stage, this stage is marked by a movement that is getting better. After trying many movements accompanied by movement strategies, a student at this stage becomes bound and chooses a certain movement pattern. Movement becomes more consistent, with fewer errors. The ability to make movements with external objects/events and also to correct deficiencies such as attention to self-movement, allowing students to start doing new things. It is also advantageous in its ability to adapt into motion adapted to various environmental conditions. (3) Automatisasi stage, at this stage, students need to practice with a long time. Actually, not all students will achieve this final stage.

In the automation stage, performance reaches the highest level of proficiency and has become automation. Students' attention during this stage is relocated to strategic decision making. In addition, multiple tasks can be performed simultaneously. Finally, students in this stage are consistent, feel confident, make a little; errors and can generally detect and correct the mistakes they make. Further strengthened [12] Basic movement skills are skills that students usually do to improve the quality of life which are divided into three categories, namely: locomotor, non-locomotor, and manipulative. Followed by [13] Skills are actions that require movement activities that must be learned in order to get the correct form of movement. A person is said to be skilled if he can move according to the right movement.

### **1. Locomotor Movement**

Movement to move) where certain body parts move or move. For example walking, running and jumping; (1) Walking is a movement to step in all directions that is carried out by anyone and knows no age. (2) Running is a development of the movement of walking. The difference lies in the rhythm of the swing steps. In running, the rhythm is faster and at certain times both feet don't touch the ground. (3) Jumping/jumping is a movement to lift the body from one point to another that is farther or higher with a fast or slow pace of running by supporting one battery and landing on the feet/other limbs with good balance.

*In research, [7] Many stated that to build the competence of fundamental motor skills (FMS) it is important to be very important in building more specific movement patterns in context that allow for a lifetime of movement experience, one of which is locomotor motion. Locomotor skills involve navigating the body through space with special patterns of movement (eg, symmetrical, asymmetrical, lateral); object control skills involve manipulation of goods either by projecting or receiving them; and stability skills involve stabilizing the body's center of gravity.*

## 2. Non-Locomotor Movement

Non-Locomotor motion (movement does not move) where only certain parts of the body are moved but do not move. For example pushing, pulling, bending and twisting. Push/Reject from the back or the front. Example; push the wall. (2) Pulling/Pulling (to get close, forward, up, out). Example; tug of war game. (3) Bending/Folding (things that are a bit stiff). Example: lift your right leg while bent at a 90 degree angle. (4) Rotate / move so that it spins (turns around). Example; Turn both arms in front of the body. In research, [14] argued that non-locomotor motion is movement that is done in place. Without space for movement, non-locomotor abilities consist of bending and stretching, pushing and pulling, lifting and lowering, folding and twisting, shaking, coiling, tossing and so on.

## 3. Manipulative Movement

Where something is moved. For example throwing, catching, kicking, hitting and other movements related to throwing and catching. Throwing is a movement to direct an object that is held by swinging the hand in a certain direction. This movement is done using the strength of the hands and arms and requires the coordination of several elements of the movement. (2) Catching / The beginning of the effort to catch that is done in the form of hand movements to stop an object that is threaded on the floor and objects that are nearby. (3) Kicking/Flap movement is a movement that maintains body balance in a standing position on one leg while the other leg is lifted and swung forward. (4) hitting/hitting movements, for example hitting the ball, are carried out in the following manner; At first the child tries to swing his arms with his arms straight up in front of him. Furthermore, the movement will develop and be able to hit the ball from the side towards the front and hit the ball overhead.

*The results of the study, [1] That the manipulative skills of boys are superior compared to girls and therefore a demonstration of competence in manipulative skills is very important to promote healthy levels of physical fitness for boys and girls. This study shows that manipulative skills used to play a variety of physical sports teams and individual physical education are an essential content of elementary school students to learn and improve manipulative skills that involve a game so that there is a relationship between manipulative skills and physical fitness of students in fourth grade elementary school.*

Based on the understanding of motor learning, the identified elements in motor learning are as follows: (1) [10] motor learning is a motor learning process is an internal process that occurs in students/athletes, due to external factors (circumstances outside of students that influence their motor development) and internal factors (student characteristics: intelligence, body type, motor skills, etc.) Based on the information processing learning theory, motor learning occurs because of the incoming information, which is then processed and actualized in the form of motion. (2) The result of learning is the ability to respond which is actualized in the form of movement. The final result is expected that students can master the internal factors of a skill and do it regularly and on time. The quality is measured from the performance when doing the movement and the results of the movement (response). (3) The ability or movement that is produced is relatively permanent. The motor skills that are mastered and learned by students/athletes can be attached to themselves for a relatively long time.

[10] Human ability to remember is very limited, it is getting less and less and can even be lost or completely forgotten. (4) Movement skills as a result of practice and experience Motor skills are not due to growth, development and maturity, but the result of practice, according to [6]. (5). Changes can be negative or positive. Athletes practice every day in essence, they want to improve the motor skills that have been mastered and maintain the achievements that have been achieved. But learning/training results do not always lead to continuous improvement, because many factors affect the increase in training results. The benefits of motor learning include the following:

1. So that students/athletes can acquire skills and then practice to improve those abilities.

2. Provides permanent changes in behavior to perform movements correctly as a result of motor learning.
3. Can provide feedback related to the feeling of continuous movement that already exists from the results of training in the nervous system that has been stored by memory to automate movement.
4. Improving coordination between perception and action properly and correctly and automating the movement of movement skills. Can take advantage of the mechanics of the musculoskeletal system to optimize the efficiency and consistency of movement. Conclusion

The concept of the process of motion occurring is starting from the learning stage that learning motion is a process of gaining knowledge, the unit process is associated with practice or experience that leads to relatively permanent changes in the ability to produce skilled motion. [4] reflects 4 concepts namely: (a). Learning is a process of acquiring the ability for a skillful movement, (b). lessons are obtained from an experience or practice, (c). learning cannot be measured directly instead the core of behavior, (d). Learning outcomes are relatively permanent changes in behavior, not changes to learning thinking.

From some of the expert opinions above, conclusions can be drawn about the concept of motor learning namely: that the motion that arises due to the response and stimulus means that humans will move because they want something they need or want, make effective and efficient movements in achieving goals. Furthermore, in carrying out the movement requires correct movement coordination, the aspects involved in the coordination of all members of the body so that they can work well together. In motor, the elements that determine are: 1. Muscles, 2. Nerves, and 3. Brain. The three elements carry out their respective roles in a "positive interaction", meaning that one element is interrelated, supports each other, complements each other with other elements to achieve a more perfect motor condition.

- a. The formation of the concept of motion when learning is how to kick a ball, children will not learn it separately and children will not learn to kick for each varied bait ball, but children will learn to group responses as a concept as a movement developed by various responses. according to the needs. The concept of human motion according to experts, namely:
- b. The concept of human motion [15] quoted by Cheryl suggests that in learning motion there are 3 stages, namely: (1) In the cognitive stage, students become aware of the movements being studied,

while mastery of movements is not yet good, they are still in the stage of experimenting with movements. The learning process begins with actively thinking about the movement being studied. Students try to know and understand the movement of previously learned information to the form of skills they face now. (2) In the association stage, students are able to perform movements in a series that does not falter. The ability to recognize motion errors is needed to increase mastery of motion. By continuing to practice repeatedly, the movement will become more efficient, smoother and in accordance with the wishes. (3) Auto Stage, learners master movement skills automatically. Students are able to perform skill movements without being influenced, even though when doing movements students must pay attention to other things besides the movements being carried out. To reach the automatic stage requires repeated learning and practice. Movement skills can be interpreted as the ability to carry out certain movement tasks well. The better the mastery of movement skills, the more efficient the implementation will be.

- c. The concept of human movement according to [16] Movement skills can be categorized into 2, namely: (1) Open motor skill is a movement skill which in its implementation occurs in changing environmental conditions and the actor moves to adjust to the stimulus that arises from the environment. Example: mountain bike. Perpetrators are forced to observe road conditions, speed, direction and balance. (2) Closed motor skill is a movement skill where its implementation occurs in unchanging environmental conditions and the stimulus for movement arises from within the actor himself. Example: back roll. The performer starts when he is ready to do it and moves according to what was planned.
- d. The concept of human movement manusia Anne Shumway-Cook. Based on the differences in movement skills can be categorized into 3, namely: (1) Discrete Motor Skill is a movement skill where in practice it can be clearly distinguished the starting poin and ending point of the movement. Example: 1x front roll. the starting point of the movement is when the perpetrator is squatting and placing both palms and the nape of the neck on the mat, while the end point is when the actor is in a squatting position again. (2) Serial motor skills are discrete motion skills that are performed several times continuously. Example: roll forward several times. (3) Continuous motor skill is a movement skill that cannot be easily marked the starting point or ending point of the movement. Example: tennis.



The starting point and ending point of the movement is not easy to know because it is a series of various movements.

It has been argued that the basic motions of humans are walking, running, jumping and throwing. The combination of basic movements is the development of basic movements that are applied and developed through various variations of basic movements. The combination of basic movements aims to foster and improve physical fitness, as well as to improve optimal performance in a sport. The forms of combination of basic movements, among others;

1. Various combinations of walking and running.  
Example; walk with long strides, then run as fast as possible.
2. Combination of running and jumping.  
Example; run slowly, at a predetermined limit jump up as high as possible.
3. Combination of running and throwing.  
Example; run as fast as possible while carrying the ball. At some point throw the ball.
4. Combination of walking, running and jumping.  
Example; walk normally, if there are signs of running as soon as possible then jump on the sandbox.
5. Combination of walking, running and throwing.  
Example; walk a few meters, then run and stop throwing the ball on target.
6. Combination of togok, arm, shoulder and leg movements.  
Example; contorting the body, pushing objects that do not move (walls).
7. Basic movements in various forms of walking.  
Example; imitating the walking of one of the animals.

## References

- [1] S. Z. Weiyun Chen, Steve Mason, Austin Hammond Bennett, "Manipulative Skill Competency and Health-Related Physical Fitness in Elementary School Students," *J. Sport Heal. Sci.*, vol. 5, no. 4, pp. 491–499, 2016.
- [2] W. Li, "Understanding the Meaning of Effort in Learning a Motor Skill: Ability Conceptions," *J. Teach. Phys. Educ.*, vol. 25, no. 3, pp. 298–309, 2006.
- [3] W. Chen, W. Zhu, S. Mason, A. Hammond-bennett, and A. Colombo-dougovito, "Effectiveness of Quality Physical Education in Improving Students' Manipulative Skill Competency," *J. Sport Heal. Sci.*, vol. 5, no. 2, pp. 231–238, 2016.

- [4] R. A. Schmidt, *Motor Learning and performance from Principle into Practice*. Champaign: Human Kinetics, 1991.
- [5] J. B. Oxedine, *Phychology of Motor Learning*. New Jersey: Prentice HallInc, 1984. [6] B. E. Rahantoknam, *Belajar MotorikTeori dan Aplikasinya dalam Pendidikan Jasmani dan Olahraga*. Jakarta: Rahantoknam, B. Edward, Belajar MotorikTeori dan AplikProyek Pengembangan Lembaga Pendidikan Tenaga Kependidikan, 1988.
- [6] E. K. Webster, C. K. Martin, and A. E. Staiano, "Fundamental Motor Skills, Screen-Time, And Physical Activity in Preschoolers," *J. Sport Heal. Sci.*, vol. 8, no. 2, pp. 114–121, 2019.
- [7] M. Asmawi, "Dimensi Pembelajaran Keterampilan Gerak Dalam Pendidikan Jasmani," *J. Olahrag, Fak. Ilmu Keolahragaan Univ. Negeri Jakarta*, p. 133, 2006.
- [8] Richard A. Magill, *Motor Learning and control concepts and application*. New York: McGraw-Hill, 2007.
- [9] R. N. Singer, *Motor learning and Human Performance: An Application to Motor Skills and Movement Behaviors*. New York: Macmillan Publishe, 1980.
- [10] Fitts and Posner, "Learning and Skilled Performance in Human Performance." Brock-Cole, Belmont, USA, 1967.
- [11] A. M. Yudha M. Saputra, *Perkembangan Gerak dan Belajar Gerak*. Medan: Departemen Pendidikan dan Kebudayaan, 2000.
- [12] Y. Kiram, *Belajar Motorik*. Jakarta: Depdikbud Dirjen Dikti., 1992.
- [13] A. Hidayat, "Peningkatan Aktivitas Gerak Lokomotor, Nonlokomotor Dan Manipulatif Menggunakan Model Permainan Pada Siswa Sekolah Dasar," *J. Pendidik. Jasm. dan Olahraga*, vol. 9;2, no. September, pp. 21–29, 2017.
- [14] F. and Posner, *Motor Learning and Control*. New York: Mc Graw Hil, 1967. Gallahue, dkk, *Understanding Motor Development: Instant Children Adolescents Adults, Second Edition (New York: Mc Graw Hil, 2012)*. New York: Mc Graw Hil, 2012.

# Implementation of Quality-Based Islamic Worldviews Competitiveness in Industry 4.0 and Era of Society 5.0

Novi Indriyani Sitepu

## Introduction

Resolution 4.0 and society 5.0 differ in their focus. In society 5.0 focuses more on the human context. If the resolution industry 4.0 uses tools and artificial intelligence as the main components, then society 5.0 makes humans the main component and modern technology is a tool controlled by humans. Humans are able to create technology, minimize inequality in humans and economic problems.

Humans in Islam have a major role as world prosperity as well as world destroyer. Because of its role, that can repair as well as damage. Humans in the context of Islam are very compatible with Society 5.0. Humans are mandated by God to prosper and manage the world to benefit in a balanced way. However, it is also caused by human activities which cause nature to be damaged and the occurrence of many natural disasters that can result in death

Humans in Islam have two functions are: 1) *Abdun* as a form of servanthood that is religious ritual in the form of a relationship with God; and 2) *Khalifah* as God's representative in managing the universe. The universe is a facility for humans to collect provisions for life in the afterlife. Because of these two functions, God gave humans three main potentials, are: the power of reason, the strength of the heart and physical strength. The human potential is used as a human provision in carrying out its functions as *abdun* and *khalifah*.

Islam teaches humans to do everything by prioritizing quality. All forms of work done by humans must be based on quality. Rewards are an indicator of the assessment of the quality of human work. This encourages people to try to do good deeds (good behavior). So that based on the study of economic verses and hadiths, it can be understood that humans must be qualified and quality encourages the emergence of competitiveness in human performance. In the Islamic context, competitiveness and quality must be framed in sharia and oriented towards *maslahah* (goodness).

The *maslahah* orientation is certainly produced from quality humans called *ihsan*. *Ihsan* has a deep meaning, the image: worship as if you will die tomorrow and work as if you will live forever. The picture shows that whatever is done must be of good quality, both worship and *char*.

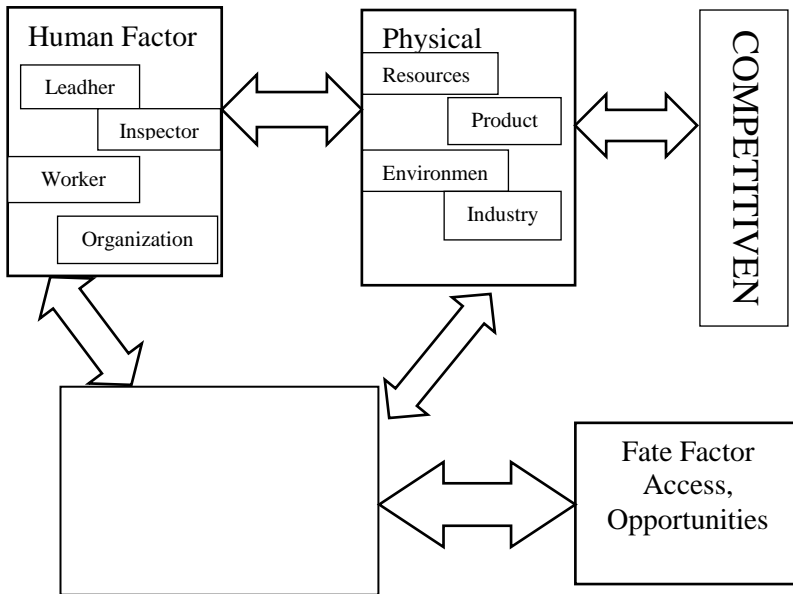
## **Discussion**

Cho's theory is motivated by the need for a model that says not how many levels of resources a country has, but who is able to create resources and when they are created. This theory can be said to complement Porter's diamond model and emphasizes the human factor as a stimulus for business dynamics [5]. Usually underdeveloped countries are more dependent on natural resources than develop and give rise to a business environment. Meanwhile, humans depend on the stage of development of the country, they are developing countries there will be many groups of workers, giving rise to politicians and bureaucracies which give birth to entrepreneurship and the presence of technical personnel and professional designers.

The economic status of a country is determined by its international competitiveness, so that a country also moves from the stage of backwardness to being developing, semi-developed and advanced. In the concept of an Islamic worldview. Quality as a boost to the desire to compete professionally. Then the model can be formed as shown in the following figure 1.

The difference between the Quality-Based Islamic Worldviews Competitiveness model with Dong Sung Cho's 9 Factor Theory is in the box where in this model all factors are in one box which will simultaneously increase competitiveness. This means that the human factor is the driving force for physical factors and both must be of high quality. The three factors have an interdependent relationship and influence each other. Meanwhile, Access and Opportunity are the causes of the slow pace of competitiveness being implemented.

**Figure1. Quality-Based Islamic Worldviews Competitiveness Models**



The Competitiveness of Islamic worldviews based on quality can be described as follows:

1. The Competitiveness

The concept of competitiveness is based on the basic concept of the Islamic worldview, they are that all activities must be of high quality (QS. Al-Baqarah: 148), based on a fighting spirit (QS. Al-Jumu'ah:10), motivation and optimism to achieve professional quality work, with an Islamic and fair work ethic. Allah commands humans to compete in the quality of amal (QS. Al-Maidah: 2) so that competitiveness can be measured by the level of achievement obtained, they are competitiveness based on the personal-quality.

2. The Quality

The basic concept of quality is based on the Islamic worldview, they are doing everything seriously (QS. Al-Insyirah:7) in order to give the best results (QS. AL-Baqarah: 267) by understanding and being able to take responsibility for it (QS. Al-Isra': 36) and carry it out as worship (QS. Al-An'am: 162). The indicators of spiritual

quality are piety and Islamic morality. Meanwhile, the indicators of intellectual quality are competence and skills, and physical and health indicators are performance. The Quality does not only emphasize the final aspect are product and service but human quality, process quality and environment quality too. It is impossible to produce quality products and services without quality people and products [9].

3. The Human Factor [8].

Humans are implementers and movers. Human potential as the driving force of the organization in realizing its existence, this potential is an asset and functions as capital in the organization. Human relations are recommended in Islam (QS. Al Hujurat: 10-13; QS. Al-Anfal: 63) that humans are social beings who need other people and are responsible for all their activities both as *abdun* maupun *khalifah*. This position to accountable for God as a form of servanthood (*abdun*) and accountable to humans as a form of God's guardian (*khalifah*) in charge of maintaining the prosperity of the world. *Abdun* maupun *khalifah*.

a) Leader

The basic concepts of leaders in Islam are (1) Strong means is *power, strong, potential*. This strength is associated with spiritual, intelligence: (2) Amanah and keeping promises means *secure, trustworthy, loyal, honest, guarantor, keeper, guardian, head*: (3) Making regulations (QS. An-Nisa':58) and being responsible

b) Supervisor (*Ar-Riqabah*)

Supervision is carried out to straighten the crooked, correct the wrong and correct the right. The Qur'an provides a firm conception so that harmful things do not happen. Humans are losers except for those who believe and do good deeds (Surah Al-Ashr: 2-3). This situation shows that what makes people lucky is faith and amal salih, are actions that are accordance with performance.

c) Workers (*'Amiil*)

Work based on the basic concepts of Islam, they are Islam recommended to work professionally (QS. At-Taubah: 105) through quality improvement including through are training, competence and discipline [1]. Every one works according to their profesision. Human in Islam are known are rational economics agents working on various interest are personal and God, social and environment. In concept Islamic

economics, ethics is considered as a form of human behavior [6]. So that, all human work must be done with fith and good morals so as to produce ihsan according to sharia.

d) Organization (*At-Tandziim*)

The organization is based on the basic concept of Islam (QS. Al-Imran: 19) are requires cooperation and commitment, work done regularly and directed will get good results. So it needs a directed and orderly process through coordination, discipline and mutual cooperation [7].

4. Physical Factor

Physical factors are: parts that will be processed by humans to be utilized. Allah SWT. Has provided facilities for all necessary resources through the law of "*taskhir* [3] which is to subdue the entire contents of the heavens and the earth for human to be mobilized and utilized properly [11]. Nature was created by God, one of which is for needs of human life which must be maintained and taken advantage of.

a) Resources

The kinds of resources are: natural resources and human resources. Human needs nature and other human in utilizing universe [10]. So it, natural resources and human resources are the two saids with the most potential in development.

b) *Supply* and *Dimand*

Demand is one of the elements that move the market, the desire that arises in consumers which is something complex. According to Ibnu Taimiyah, opinion, it comes from Allah. Supply is an important force in the market as the availability of goods in the market [2].

c) Environment

The basic concept of Islam teaches us to take care of the environment in a good way. The quality of the environment is an indicator of development and the teachings of Islam as a technology to manage. However, many humans are causing environmental damage. God emphasizes humans to take care of the environment.

d) Supporting Industry

Islam regulates the relationship between business actors (QS. Al-Baqarah: 188) in industrialization on the basis of mutual importance to each stakeholder (business processes with limitations on how to obtain goods/services according to sharia) fairly. Islam views that the factors of production in

economic activity (QS.Al-Imran: 109) basically belong to Allah and to him all affairs are returned.

5. Access and Opportunity.

Access and opportunity are based on the basic concepts of Islam. Access (QS. Al-Insyirah:7) is in the form of convenience facilities, methods and ways of obtaining something must be in accordance with Islamic law. And opportunity (QS. Al-Anbiya': 90) is the existence of destiny in the form of opportunity and utilization. There is a recommendation to make the best use of time, so as not to waste the opportunity.

This quality-based Islamic world views competitiveness model illustrates that in Islam doing something must be optimal and quality, so that the source of the movement of quality physical factors is humans, humans move because of opportunities and easy access to movement. And the reference of everything is the quality of both physical, human and non-physical.

The existence of quality will drive more conducive competitiveness, namely according to sharia, where the competition that occurs is competing to provide the best performance in itqan in all respects. Professionalism in Islam is an act that is loved by Allah as in the hadith of the Prophet Muhammad. in the history of Tabrani, they are: "إن الله يحب إذا عمل أحدكم عملاً أن يتقنه" which means "Indeed, Allah loves people who when doing a job is done in itqan". So that if a job is handed over to someone who is not an expert, it will be destroyed, as in the hadith of the Prophet Muhammad. narrated by Bukhari, they are: "إذا أسند الأمر إلى غير أهله فانتظر الساعة" which means: "If a matter is handed over to those who are not experts then wait for the moment (destruction)" [4]. Therefore, in Islamic world views, all activities must be of the best quality. Good quality will lead to good competitiveness according to the Islamic frame.

In the era of industry 4.0 and Society 5.0, humans are transferred to the function of equipment if the human is not able to master the equipment. Therefore, the implementation of quality in all lines of life activities is highly recommended considering this is in accordance with the human function as the vicegerent of Allah and the benefits of the earth being created, namely for human needs. Therefore, based on the Wolviews Islamic competitiveness model, it is very suitable to be used as the basis for carrying out the concept of competitiveness in the era of society 5.0. because at this time humans are at ease of access due to rapid technological developments. This



model shows the importance of trying to the maximum and the results of the effort left to fate.

## Conclusion

Humans in carrying out life activities must be of quality. The quality of human performance will lead to healthy competitiveness. Competitiveness in Islamic worldviews shows that quality factors, physical factors and human factors have an interdependent influence. The success of the performance of these three factors is determined by the factors of access, opportunity and destiny from God.

## Reference

- [1] A.P. Mangkunegara and A. Waris, Effect of Training, Competence and Discipline on Employee Performance in Company (Case Study in PT. Asuransi Bangun Askrida), *Journal Procedia-Social and Behavioral Sciences*, Vo. 211, 25 November 2015, pp 1240-1251
- [2] A. Rahmi., Mekanisme Pasar dalam Islam, *Journal Ekonomi dan Bisnis*, 2015. Vol. 4 No. 2, pp.177-192
- [3] A. W. Munawir, *Al-Munawir Kamus Arab Indonesia*, Surabaya, Pustaka Progress, 1997.
- [4] Bukhariy, *al-Jami'ah al- Shahih al-Mukhtashar*, Jilid I, Beirut, Dar-al Kitab, tt
- [5] D.S. Cho and M.H. Chang, Evolution of competitiveness Theory from Adam Smith to Michael Poter, Publisher by word Scientific, 2000
- [6] H. Furqani, The concept of human development in the nation of economic man: secular and islamic perspective, *Media Syariah*, Vol.XIII No.2 Juli-December 2011, pp. 131-147
- [7] H. Safri, Manajemen dan Organisasi dalam pandangan islam, *Journal of Islamic Education Management*, Vol.2 No 2 Oktober 2017, pp. 153-166
- [8] I. Fakhri, Konsep Potensi Manusia (di Tinjau dari Perspektif Islam), *Transformasi: Jurnal Studi Agama Islam*, Vol.11, No. 2, 2018
- [9] J. S. Baran and D. K. Davis, *Mass Communication Theory: Foundation, Ferment and Future*, California: Wadsworth Publishing Company, 2000, pp. 50
- [10] M. Ihsan, Perspektif Filsafat Pendidikan Islam tentang Alam dan lingkungan, *Jurnal Hunafa*, Vol. IV, No. 31-40, Maret 2017, pp. 32

- [11] Y. Tricahyani, Urgensi Sumber Daya Insani dalam Institusi Perbankan Syariah, *Muslim Heritage*, Vol. 3, No. 1, pp. 87-105, 2018

# **Disease Perception And Its Relation To Quality Of Life Of Undergoing Haemodialysis Patients**

Nur Chayati, Nur Aini Handayani

## **Introduction**

Hemodialysis is a method of washing the blood, to replace damaged kidney function. In Indonesia, the number of patients with kidney failure cases continues to increase every year. Data from the Indonesian Renal Registry (IRR) in 2015 showed that there were around 1,885 active undergoing hemodialysis patients in 2007 and this number continued to increase to 30,554 patients in 2015. This number was obtained from 249 kidney units that sent data from a total of 382 kidney registered units (Indonesian Nephrology Association [1]. While in Yogyakarta, Central Java, Indonesia there were 717 active undergoing hemodialysis patients from 22 kidney units registered in Yogyakarta [1]. There are 153 patients who are routinely scheduled to undergo hemodialysis therapy and there are 83 patients who perform hemodialysis therapy independently or unscheduled at RSUP dr. Sardjito Yogyakarta in 2019 [2].

Undergoing hemodialysis patients have physical problems such as blood pressure instability, anemia, skin itching, muscle cramps, and weight gain [3]. Not only have physical problems, hemodialysis patients also experience various psychological problems. This is due to the discomfort and limitations of the hemodialysis therapy process undertaken by the patient. Discomfort in the patient will have a frustrating effect. This happens because the patient is afraid of being a burden to the family. There is a guilt which arises or useless feeling which is caused by the uncertainty of the future due to the illness. This can make the patient depressed, because the patient has to limit everything he wants to do, such as limiting fluid intake, limiting food intake, limiting work, and limiting creativity [3]. Patients cannot play their roles optimally in their environment due to their limitations [4]. Some of the patients' problems in terms of physical, psychological and economic will affect the patients' quality of life [4].

The impact of hemodialysis on the patients' quality of life depends on the point of view of the patients' perception of the disease he is suffering from [5]. Previous study stated that from 60 respondents, 75% had a moderate quality of life category [6]. However, another study showed that from 67 patients, a half of the

respondents (50.7%) had a good quality of life [5]. It is inline with a study at Yogyakarta which stated that 86.8% of patients (from 37 patients) had a good quality of life while the other 13.2% were still poor [7]. From several studies that have been carried out, it can be seen that the impact of hemodialysis on quality of life is still quite varied from bad to good.

Perception is a prejudice that is believed by the human person, the perception that is believed to be between one another is not necessarily the same, because it depends on the mindset of each individual [8]. The perception of illness is about how a person stigmatizes himself for what he believes. Chronic kidney failure (CKD) patients have different perspectives from one another about the perception of their disease [9]. In one study stated that there is a positive or unidirectional relationship between perception of pain and quality of life [10]. Patients who can control their perception of their health will produce a good quality of life, while patients who cannot control their perception of their health will have a low quality of life [10]. Perceptions of disease and the relationship between perceived disease and quality of life in renal failure undergoing hemodialysis patients have not been studied much, so that the purpose of this study was to examine the relationship between disease perception and quality of life in renal failure undergoing hemodialysis patients. This study was a cross sectional approach to 113 patients with a total sampling method. Data collection using the B-IPQ Indonesian version to measure the perception and KDQOL questionnaires for quality of life assessment.

## **Discussion**

### **Patients' perception of the disease**

Patients have a good perception of the impact of illness on life. The average total score of the eight B-IPQ questionnaire items is 48.4 (slightly above the middle limit of 40 with an average total value range of 0 to 80). It indicates that chronic kidney disease is not considered as something that causes worry and anxiety (Table 1).

**Table 1. The average value of items 1-8 questionnaire B IPQ**

Question item	1	2	3	4	5	6	7	8	Total
Average	6,4	4,8	6,9	7,1	5,3	5,2	7,2	5,5	48,4

\*Notes: 1 (consequence = patients' belief about how strong the influence of the disease on the patients' quality of life), 2 (timeline = belief about the time susceptibility of chronic disease), 3 (personal control = belief of the patient about his or her ability to control the disease), 4 (treatment control = the patients' beliefs about pain control by using drugs), 5 (identity = concerns about the experience of symptoms that arise as a result of the development of the disease), 6 (concern = about feelings such as feelings of worry or concern about the patients' illness) , 7 (comprehensibility = a description of the patients' understanding of his illness), 8 (emotional response = the patients' emotional response to his illness).

The patient was able to accept that his current illness could not be cured, but could be controlled by doing scheduled therapy. This is in line with research on the kinetics of the left ventricular segment of patients with end-stage chronic renal failure which stated that there was a significant effect after undergoing hemodialysis therapy with before undergoing hemodialysis therapy [11]. This good perception is also influenced by a high level of patient education as much as 76%, a person's educational status is one of the important factors in determining health status. The higher the level of education, the awareness of health will increase [12]. The knowledge and skills that must be possessed can improve welfare and better perceptions, the better the level of education, the better one's perception [13]. Good perception is also related to marital status, this is associated with the support of people around with information and knowledge obtained through the marriage process related to perceptions that affect patient trust [14].

The patients perception of their concern about the progress of the disease is poor. The time factor affects the patients' perception of the disease, usually the longer the patient are exposed and undergoing treatment, the better the patients' perception over time [15]. However, in contrast to the results obtained in this study, the longer the patients were exposed to chronic kidney failure, the

patients' perception actually became worse, this could be related to the patients' concern about the disease that could not be cured, the patients' concern that he had to undergo hemodialysis regularly, and maintain A healthy lifestyle makes patients tend to need a process and time to accept their current condition. The time required differs from one patient to another according to the coping of each patient. Undergoing hemodialysis patients therapy require admission time, which is 2 weeks - 3 months depending on their condition [16].

The patients believe that they can control their illness. There are 65% of patients who are no longer working. This is because the patients should not be overworked and exhausted. The limitations of the patients make the patient still have to try to maintain activities according to the portion that does not make the patient tired [17]. The condition of the patients who do not work causes the patients to have free time to maintain his condition against his illness. The patients believe that by having free time due to reducing extreme activities, their illness can be overcome with medical assistance. In addition, patients who receive family support cause patients to believe that they can handle or control their current chronic kidney failure condition [18].

The patients believe that the current treatment he is undergoing can help control his disease so it doesn't get worse. In addition to this belief, the income factor also affects, meaning that the patients' income for one month is sufficient to cover the patients' medical costs, especially patients are also helped by the BPJS program which has provided adequate funds [19]. The higher the income earned, the better one's perception [20]. Thus, patients believe that the treatment they are undergoing is assisted by adequate income and the role of the government is able to help survival. Although it cannot cure the patient completely, the treatment that the patient undergoes is able to control the disease so that it does not get worse [11].

Some patients experience quite disturbing symptoms due to kidney failure or as a result of hemodialysis therapy, these points are obtained as a result of the symptoms experienced by patients during hemodialysis therapy, such as itching, dry skin, dizziness, nausea, and no appetite. eat. Complaints of weakness, fatigue and lethargy were also found as a result of the hemodialysis therapy being undertaken [21]. Some patients are still worried about their chronic kidney failure. This concern is inseparable from the coping mechanisms of each individual, because there is a relationship between the level of anxiety or concern with the coping mechanisms of patients with

chronic kidney failure, so that when the patients' coping mechanism is adaptive, the concern about the disease will decrease. remain in high vulnerability [22].

The patients' understanding of chronic kidney failure is good. This result is influenced by factors of age and education. The 50 years age can affect the patients' perception of the disease, because age increases the understanding of each individual [23]. The higher the level of education, the awareness will increase through the knowledge and skills possessed, of course this will also affect the patients' understanding [13]. However, young people are also detected to have less knowledge. This is influenced by internal factors that can come from the lack of motivation of medical personnel and external factors can come from patients who tend to be difficult to receive information [24]. Physical changes and physical activity experienced by patients as a result of chronic kidney failure affect the patients' life including unstable emotions [25].

### **Patients' quality of life**

Quality of life consist of five component, symptoms or problem, effects of kidney disease, kidney disease burden, SF-12 physical health composite, and SF-12 mental health. Measuring the quality of life composite from 113 patients are shown in Table 2.

Table 2. The quality of life score of patients

<b>Scale (Scale quantity in scale)</b>	<b>Mean</b>	<b>Median</b>	<b>SD</b>
Symptoms/problem list (12)	81,91	87,50	15,32
Effects of kidney disease (8)	73,34	75,00	18,60
Kidney disease burden (4)	44,97	43,75	29,63
SF-12 physical health composite	34,47	34,27	8,68
SF-12 mental health composite	49,30	50,65	9,72

The first part of the quality of life is a list of problems that occur in patients with chronic kidney failure which is fairly high. This indicates that problems that occur in patients such as weakness, fatigue, lethargy are quite prevalent [21]. This can be related to the length of treatment and quality of life, when the patients discontinue treatment, the patient should already understand the consequences that will be experienced, and when they have to continue treatment the patient must also be prepared with the side effects that will be faced. However, over time the patients will understand that the

treatment he is undergoing will help and make his perception and quality of life better [26]. Another cause is stress and lack of family support [27]. In addition, the cost factor can also affect the list of problems, such as the high cost of hemodialysis which once therapy is around Rp.975,422,641, and patients with BPJS also have to pay around Rp. 255,593,641. This figure can be said to be high, coupled with therapy carried out 1-3 times a week, this is what makes a list of patient problems and affects the patients' quality of life [28].

The second part, which is the effect of chronic kidney failure, gets a high average value, meaning that this chronic kidney failure has quite a lot of effects. These side effects include muscle pain, chest pain, cramps, itching, dry skin, shortness of breath, dizziness or lightheadedness, no appetite, and paleness which is quite high and affects the patients' quality of life. The presence of weakness, fatigue, lethargy, peripheral edema, anemic conjunctiva, nutritional status, hypertension, and anemia are advanced diseases resulting from chronic kidney failure which is also an effect of kidney disease that affects quality of life [21].

The third part, namely the burden of kidney disease can be said to be low. This condition is associated with community-based self-awareness prevention and control of BPJS assistance as well as access to increased health facilities that reduce the burden of patients from chronic kidney failure [29].

The patients' physical health is very good. Physical health can be said to be the picture that the patient gives to his current physique or commonly called body image. The patient has a positive picture of his current physique, it can be said that the patients' body image is not disturbed, the patient can accept his physical condition that is different from before chronic kidney failure. Patients who have a disturbed body image have very little chance of having a good quality of life compared to patients whose body image is not disturbed [30]. The mental health component shows that the patients' current mental health is disturbed because the patient feels anxious and worried about his illness. Anxiety in Undergoing hemodialysis patients is caused by situational crises, death threats, and not knowing what the end result will be from the current therapy [31].

### **The relationship between the perception of the disease with the patients' quality of life**

There is a relationship between perception of disease and



quality of life in undergoing hemodialysis patients (Table 3).

**Table 3. Spearman correlation analysis of disease perception and quality of life**

<b>Variable</b>	<b>n</b>	<b>r</b>	<b>p</b>
Quality of life	113	0,315	0,001
Perception of disease			

These results are in line with the results of research conducted by Oktaviani that there is a positive or unidirectional relationship or correlation between perceptions of disease and quality of life [10]. Chronic kidney failure is a disease that requires lifelong treatment. This is what causes some patients to begin to build perceptions about the disease they are suffering from. Perceptions about the disease that are built by patients through factors of age, gender, gender, education, occupation, marital status, income, and length of time undergoing hemodialysis can affect the quality of life [32].

There is a significant relationship between the perception of disease with quality of life, but the level of association is low. Many factors cause a decrease in the quality of life, one of which is a negative perception that is built when a person cannot manage the disease he is suffering from. On the other hand, patients who think that their condition is fine tend to have a good quality of life, so the dimensions of the B-IPQ will tend to be more positive [10]. Perceptions can affect the quality of life due to physical, psychological, social, environmental factors and the quality of life itself [33].

### **Conclusion**

There is a significant relationship between perception of disease and quality of life in chronic kidney failure Undergoing hemodialysis patients. The average score of the patients' disease perception is 48.4 which indicates the patients' perception of the disease is good. The average score of the patients' quality of life is 56.81 which indicates the better the patients' quality of life.

### **References**

- [1] Perhimpunan Nefrologi Indonesia [PERNEFRI]. (2015). *8<sup>th</sup> Report of Indonesia Renal Registry*.

- <http://indonesianrenalregistry.org/data/INDONESIAN%20RENAL%20REGISTRY%202015.pdf>
- [2] Prasanto, H. (2019). "Menyambung" Hidup dengan Dialisis. <https://radarjogja.jawapos.com/jogja-utama/2019/03/01/menyambung-hidup-dengan-dialisis/>
- [3] Kusumawardhani. (2016). Efek samping cuci darah. <http://hkhkfgs.hfgugjh>.
- [4] Arosa, Jumaini & Wolferst. (2014). Hubungan lamanya menjalani hemodialisis dengan tingkat kecemasan pada pasangan hidup pasien yang menderita penyakit ginjal kronik di RSUP Prof. Dr. R.D. Kandao Manado. <http://ejournal.unsrat.ac.id/index.php/eclinic/article/download/6825/6349>
- [5] Rustandi, H., Tranado, H., & Pransasti, T. (2018). Faktor-faktor yang mempengaruhi kualitas hidup pasien chronic kidney disease (CKD) yang menjalani hemodialisa di ruang hemodialisa. Volume 1, No. 2. <https://journal.ipm2kpe.or.id/index.php/JKS/article/download/8/43>
- [6] Dewi, S. P. & Anita, D. C. (2015). Hubungan lamanya hemodialisa dengan kualitas hidup pasien gagal ginjal di RS PKU Muhammadiyah Yogyakarta. [http://scholar.google.co.id/scholar?q=kualitas+hidup+pasien+h&d&hl=id&as\\_sdt=0&as\\_vis=1&oi=scholar#d+gs\\_qabs&u=%23p%DdUmjfDRFO9AJ](http://scholar.google.co.id/scholar?q=kualitas+hidup+pasien+h&d&hl=id&as_sdt=0&as_vis=1&oi=scholar#d+gs_qabs&u=%23p%DdUmjfDRFO9AJ)
- [7] Sugiyo. (2019). Kualitas hidup pasien GJK di RS PKU Muhammadiyah Yogyakarta. <http://yogyakarta.co.id/naskah%publikasi20%%2256>
- [8] Pratiwi, A., Untari, E.K., & Yuswar, M.A. (2017). Hubungan antara pengobatan dengan persepsi penyakit gagal ginjal kronik dan kualitas hidup pasien yang menjalani hemodialisis di RSUD Soedarso Pontianak. <https://www.jurnal.untan.ac.id>.
- [9] Priyanti, D. (2016). Perbedaan kualitas hidup pasien gagal ginjal kronis yang bekerja dan tidak bekerja yang menjalani hemodialisis di Yayasan Ginjal Diatrans Indonesia. <http://repository.ac.id/ggk.hidup/5363/>
- [10] Oktaviani & Dwi, E. (2015). Hubungan persepsi sakit dengan kualitas hidup pada pasien gagal ginjal kronis yang menjalani terapi hemodialisa di rumah sakit tentara tingkat II dr. Soepraoen Malang. <http://repository.ac.id/125363/>

- [11] Kamasita, S. E., Suryono, Nurdian, Y., Hermansyah, Y., Junaidi, E. & Fatekurohman, M. (2018). Pengaruh hemodialisa terhadap kinetik segmen ventrikel kiri pada pasien penyakit ginjal kronik stadium V. <https://jurnal.unej.ac.id/index.php/NLJ/article/view/6506>
- [12] Bosniawan, A. (2018). Faktor-faktor determinan yang mempengaruhi pada kualitas hidup penderita gagal ginjal kronik di RSUD Sukoharjo. <http://eprints.umu.ac.id//59809/22/Publikasi%20ilmiah.pdf>
- [13] Nurrokhmah, R. K., Yanzi, H. & Pitoewas, B. (2017). Faktor-faktor yang mempengaruhi rendahnya nilai pada kompetensi guru (UKG). <https://www.neliti.com/publications/252774/faktor-faktor-yang-mempengaruhi-rendahnya-nilai-pada-uji-kompetensi-guru-ukg>
- [14] Taufik, M, Sutiani, H. & Hermawan, A, D. (2018). Pengetahuan, peran orang tua dan persepsi remaja terhadap preferensi di usia ideal menikah. <http://ejournal.poltekkes-pontianak.ac.id/index.php/JVK/article/view/77>
- [15] Sukmawati, A, K. (2018). Analisis faktor yang berhubungan dengan penerimaan diri pasien gagal ginjal kronis yang menjalani terapi hemodialisa di rumah sakit umum haji Surabaya. <http://repository.unair.ac.id/85199/4/full%20text.pdf>
- [16] Agustin, I, K., Asmawati & Sawiji. (2018). Respon Psikologis dalam siklus penerimaan menjalani terapi hemodialisa pasien gagal ginjal kronik. <https://ejournal.stikesmuhgombang.ac.id/index.php/JIKK/article/download/309/187>
- [17] Rosiah, Casani, S., & Hidyanti, W. (2017). Studi fenomenologi : pengalaman aktivitas fisik yang menjalani hemodialisis. <http://journal.stikeppnjabar.ac.id/index.php/jkk/article/view/78>
- [18] Novitasari, L & Wakhid, A. (2018). Hubungan dukungan keluarga dengan efikasi diri pasien gagal ginjal kronik yang menjalani hemodialisa di RSUD Kabupaten Semarang. <http://jurnal.stikescendekiautamakudus.ac.id/index.php/stikes/article/view/260>
- [19] Tania, F. & Thabrany, H. (2016). Biaya dan Outcome Hemodialisis di Rumah Sakit Kelas B dan C. *Jurnal Ekonomi Kesehatan Indonesia*, 1(1), 1-54.

- [20] Novayanti, D., Bunuwa, I. S., Safe'i, R., Wulandari, C., & Febriyano, I, G. (2017). Analisis faktor-faktor yang mempengaruhi persepsi masyarakat dalam pembangunan hutan tanaman rakyat pada KPH Gedong Wani. <http://www.google.com/url?sa=t&rct=j&q=&esrc=s&source=web&cd=&ved=2ahUKEwiGzK7YuYPqAhWNWX0KHbd7BmIQFjAAegQIAhAB&url=http%3A%2F%2Fjournal.unhas.ac.id%2Findex.php%2Fjhm%2Farticle%2Fdownload%2F2861%2F1698&usg=AOvVaw3zpUXDX8f6t3ALUD41fcrw>
- [21] Aisara, S., Azmi S. & Yanni, M. (2018). Gambaran klinis penderita penyakit ginjal kronik yang menjalani hemodialisa di RSUP Dr. M Djamil Padang. <http://jurnal.fk.unpad.ac.id/index.php/jka/article/view/778>
- [22] Fay, D. S. & Istichomah, I. (2017). Hubungan tingkat kecemasan dengan mekanisme koping pada pasien CKD (Cronic Kidney Disease) yang menjalani hemodialisa di RS Condong Catur Yogyakarta. <https://www.nwli.com/id/publications/137795/hubungan-tingkat-kecemasan-dengan-mekanisme-koping-pada-pasien-ckd-chronic-kidne>
- [23] Akhmad, A. D., Satibi & Puspendari, D. A. (2015). Analisis persepsi dan faktor yang mempengaruhi persepsi terhadap penerapan sistem pembiayaan JKN pada fasilitas kesehatan penunjang di D.I Yogyakarta. [https://r.search.yahoo.com/\\_ylt=AwrX5ZYKK.deaxcAIR73RQx.;\\_ylu=X3oDMTBybjhmNXEwBGNvbG8Dc2czBHBvcwM1BHZ0aWQDBHNlYwNzcg--/RV=2/RE=1592236939/RO=10/RU=https%3a%2f%2fjournal.u-gm.ac.id%2fjimpf%2farticle%2fview%2f29456%2f17600/RK=2/RS=gToG9CRNbNfOWNwj6Fnbmbw332s-](https://r.search.yahoo.com/_ylt=AwrX5ZYKK.deaxcAIR73RQx.;_ylu=X3oDMTBybjhmNXEwBGNvbG8Dc2czBHBvcwM1BHZ0aWQDBHNlYwNzcg--/RV=2/RE=1592236939/RO=10/RU=https%3a%2f%2fjournal.u-gm.ac.id%2fjimpf%2farticle%2fview%2f29456%2f17600/RK=2/RS=gToG9CRNbNfOWNwj6Fnbmbw332s-)
- [24] Winarni, T., Sujana, T. & Gasong, D, N. (2018). Management discharge planning pada pasien gagal ginjal kronis di RS kota Salatiga. <https://ejr.stikesmuhkudus.ac.id/index.php/jikk/article/view/481>
- [25] Rosyanti, L., Hadi, I. & Ibrahim, K. (2018). Eksplorasi perubahan fisik dan gejala emosional pada pasien gagal ginjal terminal yang menjalani hemodialisis (pendekatan kualitatif). <https://www.neliti.com/publications/296594/eksplorasi-perubahan-fisik-dan-gejala-emosional-pada-pasien-gagal-ginjal-termin>

- [26] Suriya, M. (2018). Faktor-faktor yang berhubungan dengan kualitas hidup pasien TB Paru di rumah sakit khusus paru Lubuk Alung Sumatera Barat. <https://jurnal.univrab.ac.id/infrx.php/keperawatan/article/download/476/366/>
- [27] Ardiyati, H. B. (2015). Peran dukungan keluarga terhadap manajemen stres pada pasien gagal ginjal di Yogyakarta. <https://media.neliti.com/media/publications/256840-peran-dukungan-keluarga-terhadap-manajem-7c7027e9.pdf>
- [28] Rusli, N, T. (2017). Analisis biaya dan faktor-faktor penentu inefisiensi layanan hemodialisis pada pasien gagal ginjal kronik rumah sakit RK Charitas Palembang tahun 2016. [https://r.search.yahoo.com/\\_ylt=AwrXhSTeieheHiUAE0z3RQx;\\_ylu=X3oDMTBycWJpM21vBGNvbG8Dc2czBHBvcwMxBHZ0aWQDBHNlYwNzcg-/RV=2/RE=1592326751/RO=10/RU=http%3a%2f%2fjournal.fkm.ui.ac.id%2farsi%2fartikel%2fdownload%2f2221%2f758/RK=2/RS=mUVXhtWZee252bho10CmLKxFHLo-](https://r.search.yahoo.com/_ylt=AwrXhSTeieheHiUAE0z3RQx;_ylu=X3oDMTBycWJpM21vBGNvbG8Dc2czBHBvcwMxBHZ0aWQDBHNlYwNzcg-/RV=2/RE=1592326751/RO=10/RU=http%3a%2f%2fjournal.fkm.ui.ac.id%2farsi%2fartikel%2fdownload%2f2221%2f758/RK=2/RS=mUVXhtWZee252bho10CmLKxFHLo-)
- [29] Dinas Kesehatan Kab. Bogor. (2018). Cegah dan kendalikan penyakit ginjal dengan patuh. <https://dinkes.bulelengkab.go.id/artikel/cegah-dan-kendalikan-penyakit-ginjal-dengan-cerdik-dan-patuh-16>
- [30] Oxtavia, V., Jumaini, & Lestari, W. (2018). Hubungan citra tubuh dengan kualitas hidup pasien gagal ginjal kronik yang menjalani hemodialisis. <https://www.neliti.com/publications/188733/hubungan-citra-tubuh-dengan-kualitas-hidup-pasien-gagal-ginjal-kronik-yang-menja>
- [31] Wakhid, A. & Suwanti, L, N. (2019). Gambaran kualitas hidup pasien gagal ginjal kronis yang menjalani terapi hemodialisa. <https://jurnal.unimus.ac.id/index.php/JJK/article/wiew/4495>
- [32] Resmiya & Miabach. (2019). Pengembangan alat ukur kualitas hidup Indonesia. <https://ejournal.upi.edu/index.php/insight/article/view/22247/0>
- [33] Jacob & Sanjaya. (2018). Aspek kesehatan fisik. <https://www.journal.edu/23456/aspek>

# **Reconstruction of agent-based model in predicting the risk of stock On Indonesian Stock Exchange (BEI)**

Nursaid, Heru Cahyono, Muh. Fahrurrozi

## **Introduction**

The capital market is an open system that contains various sub-systems. A stock market index reflects the changing stock price from time to time, and it is influenced by the intensity of the sale or purchase of shares at a specific price and time in the stock market (open system). As various elements influence the markets, market dynamics are formed, and asset prices securities and market index changes are inevitable. Later on, the dynamics of the market itself trigger system complexity in the capital market.

The system's complexity in the capital market causes the dynamics and stimulates irrational behaviors in the market, such as over-confidence, over-reaction, and under-reaction. To this day, scholars provide theories and frameworks that aim to understand the dynamics and complexity of the capital market. For example, arbitrage principle, capital assets pricing theory, efficient market hypothesis, and agency theory. Even though conventional financial theories are sufficient in explaining linear behavior in the stock market, the empirical studies showed contrast results. Investors demonstrate irrational behavior instead, and the conventional financial theories were questioned in terms of effectivity in grasping non-linear behavior in the capital market [1].

In responding to the above phenomenon, advanced financial theories are needed. Therefore, this study intends to advance financial framework that can describe the non-linear behaviors in the capital market by adopting the Agent-Based Model. Our study attempts to advance and reconstruct the Agent-Based Complex Adaptive System (CAS) framework originated from the science of complexity by [35], to predict the stock price.

Based on several existing literature [32], [5], [14], [13], and [3], our study particularly attempts to employ an experimental method using computational simulation model to examine the role of the basic attributes and also temporal attributes in predicting the stock price. Factors that are included in the basic attributes are the investment strategy and strength of agent influence. In contrast, factors included in the temporal attributes are capital, ownership of and risk expectation.

Besides offering an additional financial framework, this study also proposes a simulation method as an alternative to forecast market behavior. Some methods such as time series analysis [2] and [22], operation research [ ], or machine learning [15], [18] are well known and have been widely applied. However, these methods are limited in the context of forecasting the non-linearity of investor behavioral aspects. Therefore, this paper may provide investors with tools to predict the firms' stock price and minimize potential loss and risk caused by poor estimation.

Modern financial economics theory is built based on the assumption that market players act rationally in two points. *First*, in making a decision, the market player refers to the utility theory axiom. *Second*, there will be no unbiased forecast. Based on the assumption of rationality behavior, a market player naturally has a risk-averse attitude. Additionally, the utility function of a market player is a marginal utility towards the declining welfare, and the shape is concave. The price shaping of an asset happens because of the rationality attitude of an investor towards the equilibrium market, so it refers to the efficient market hypothesis function..

Experts make many attempts to understand the character of an asset or investment return. The attempts are managed so that the factors influencing investment return can be identified. For example, the statistic model from [20] framework explained the standard deviation of a return that is considered as a risk reflection of an asset. This model develops in stochastic data, such as the Markov model, price arbitrage principle from Miller and Modigliani, and the more specific one is the option price model by Fisher Black, Myron Scholes, and Robert Merton [17].

Referring to the efficient market hypothesis, the financial asset price should reflect all available information so that the accurate estimation of asset investment can be performed at any time. The implication of reasonable asset prices in an efficient market is that there will be a slight chance that an investor obtains abnormal returns without conveying risk [29]. Empirical researches about risk management are commonly performed, such as research by using various variables. Some other researchers used experimental methods such as [27], [33], [31], [6], [32].

Although scholars were determined to study market and risk in an efficient setting, the empirical reality of the stock market, especially in a foreign country from 1980 until 1990, shows that there were many irregular situations from the ideal efficient market. In

other words, there were a lot of irrational situations of an investor towards new information. Investors at that moment showed an overconfident and underreaction attitude toward new information, for instance, an initial public offering (IPO), merger, stock split, and spin-off [25]. Volatility clustering and fat tail distribution of asset returns are examples of these so-called stylized facts [7], [8], [11]. In the same period, information technology media sometimes gave biased information, thus causing inaccuracy in investment decisions [23].

The complexity of the capital market system stimulates irrational behaviors in the market. These irrational behaviors cause non-linear stock market financial data. The non-linear data could appear in several forms, such as excess kurtosis, fat-tail distribution, and multifractality [32], [5], [14], [13], and [3]. Conventional financial theories frequently build on the linearity approach. This linearity approach is less effective in grasping and accommodate dynamic and non-linear behavior in the capital market.

The ineffectiveness of conventional financial theory and financial risk studies is becoming a concern for many scholars [10]. The non-linear data characters promote financial theory advancement through behavioral finance theory in the 1990s. The theoretical concept of behavioral finance is formed based on two understandings, cognitive psychology and the limits of price arbitrage. Behavioral finance is likely to utilize the bottom-up approach in observing the stock market rather than a conventional top-down approach. In the bottom-up approach, the agent is believed to have a more significant role in the dynamic changes of the market (price and index). An agent's vital role is to uphold an alternative model using computing simulation, the Agent-Based approach. One of the models of the approach is the Agent-Based Model.

### **Agent-Based Model**

Agent-based model as disaggregate model, starting the idea by constructing the computational devices (known as agents with some properties) and then simulating them in parallel to model the real phenomena. The process is emerging from the social system's lower (micro) level to the higher level (macro). The agent-based model's history can be traced back to the [34], a theoretical machine capable of reproduction. [34] proposed a device that would follow precisely detailed instructions to fashion a copy of itself. The finding



was a theoretical model with a reproductive ability developed by Von Neumann's partner, Stanislaw Ulam, a mathematician.

Agent-based modeling of human social behavior is an increasingly important research area. For example, it is critical to designing virtual humans, human-like autonomous agents that interact with people in virtual worlds. A critical factor in human social interaction is our beliefs about others. During social interaction, our models of communication can affect the delivery of messages. The actions we take are influenced by how we believe others will react. Even though the interaction is considered in computational models, the theory of mind is rather ignored.

In the Agent-Based Model, the social agent is viewed as an object. When the situation is considered as not well established and complex, it consistently relies on the fundamental value in the agent who has dynamic interaction like in the real world [30]. The agent is assumed to have intelligence, ability, and utility, but the agent cannot enrich the cognitive experience except by using game theory. The underlying game theory utilization is also reasoned from a space and time perspective faced by agents and agents' response towards the situation described in the computing algorithm as an agent's form of behavior [26].

### **Hypothesis development**

The basic attributes consist of investment strategy and the power of the agent's influence. The investment strategy consists of three categories, which are fundamentalist, chartist, and noisy. Fundamentalist strategy is a strategy that always tends to keep the price in a definite value. Chartist strategy is a strategy in which the agent monitors the market's tendency based on historical data. The noisy strategy is buying randomly with 0,5 probability but just going to sell if the agent feels secured (for example, finding two other randomly selling agents). [36] found that investor strategy, either as fundamentalist, chartist, or noisy, may determine the investor decision and eventually determine the stock price. According to this finding, we predict that the investment strategy determines the investor behavior and eventually affects the stock price.

Agent influence power is defined as the influence of one agent on another agent in determining their decision to short futures, inactive, or long futures. [24] found that an agent's trading decision is based on sentiment. Consequently, the stock price process depends on the propagation of information among the interacting agents, budget

constraints, and market feedback. Based on [24] finding, we predict that agent influence power may become a predictor for the investor behavior and determine the stock price.

Meanwhile, the temporal attributes consist of capital, ownership, and risk expectation. Capital is stated as money and/or shares that will be invested later. Ownership is the number of shares owned by the investor in the market. Risk expectation is an alleged investment risk consisting of three possibilities: a) in the money, a situation where the strike price is lower than the cash price of the stock (market price); b) out of the money, a situation where the strike price is higher than the stock cash price (market price); and c) at the money, a condition where the strike price is equal to the cash price of the stock (market price). Previous literature shows that ownership is one predictor of stock price [16], while [19] found that risk perception affects an investment decision.

Hypothesis: The basic attributes (investment strategy and the power of agent's influence) and temporal attributes (capital, ownership, and risk expectation) determines the stock price.

## **Methods**

### **Approach and data**

This research utilized an experimental method with a computational simulation model [28]. This dynamic model is created in such a way, so it is not distinct significantly from the actual situation of the capital market. This research is explanatory because it explains the causal relationship between variables [9]. The research object is an investor's basic and temporal attributes, investment strategy, investment risk, and investment performance in the LQ-45 future index.

In this research, the alternative risk expectation is the suspected investment risk using the term on derivative security. This derivative security consists of three options: a) in the money, b) out of the money, and c) at the money, along with several reasons. First, the convenience to understand the term, second, the fact that futures only uses two alternative situations, which are normal backwardation when future price below spot desired spot price, and contango when future prices above desired spot price [17].

Data used in this research is categorized into two types[28]: (1) data from the control group, LQ-45 index data from 2002-2006; and (2) data from the experimental group or simulation of the LQ-45 index obtained from the agent-based model. This period of data was

chosen based on the assumption that the Indonesian economy is relatively stable at the period, so we can minimize the exogenous factors that affect our model. The simulation process is performed up to a minimal, and the convergent deviation between the control group and the experimental group is achieved. The obtained experimental data is created on various combinations of basic attributes, temporal attributes, and investment strategy between investors.

### **Variables and measurements**

Basic attributes function as a first independent variable group, the basis, and the background of investors' behavior. This basic attribute consists of investment strategy and the power of the agent's influence. The investment strategy is the underlying investment strategy, consisting of three fundamentalist, chartist, and noisy. Fundamentalist strategy is a strategy that always tends to keep the price in a definite value. Chartist strategy is a strategy in which the agent monitors the market's tendency based on historical data. The noisy strategy is buying randomly with 0,5 probability but just going to sell if the agent feels secured (for example, finding two other randomly selling agents). Agent Influence Power is stated as the influence of one agent to another agent in determining their decision to short futures, inactive, or long futures.

The temporal attributes have a function as the second independent variable, which temporal attribute consists of capital, ownership, and risk Expectation. Capital is stated as money and/or shares that will be invested later. Ownership is the number of shares owned by the investor in the market. Risk expectation is an alleged investment risk consisting of three possibilities: a) in the money, a situation where the strike price is lower than the cash price of the stock (market price); b) out of the money, a situation where the strike price is higher than the stock cash price (market price); and c) at the money, a condition where the strike price is equal to the cash price of the stock (market price).

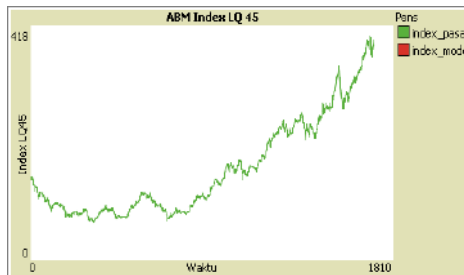
### **Results**

Based on the simulation model, an alternative input iteration process is carried out by first determining the initial configuration. The number of agents or investors is set at 100 people. According to each alternative investment strategy, the composition of the number of agents is: selling (short-futures): inactive: buying (long-futures) = 30: 40: 30. Total futures contracts traded are 5. The base

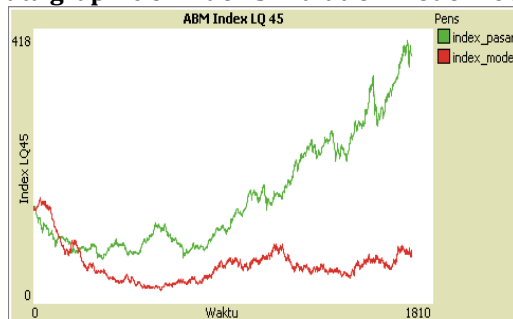
price for each contract is set at IDR 1,000,000, while the initial capital owned by the investor is IDR 1,000,000,000. The distribution of initial capital, strategy, and power of influence for each agent is given randomly at the start of the simulation iteration.

Activation from the Agent-Based Model using the Netlogo software were conducted where each agent's behavior is formulated with following details. First, the basic attributes consist of investment strategy and the influence of agents. The investment strategy consists of three different types, namely fundamentalist, chartist, and noisy. In the simulation modeling, each investor character is given a different notation, namely for the type of "fundamental" investor is (☒) while for the type of investor "chartist" is (☺), and for the type of investor "noisy" is (☺).

Based on the activation of the computational simulation model program using Netlogo software, the result shows a green color line graph visual. This line is a time harmonious data from the control group from 2000 to 2006 or during the data observation period 7-year transaction. It consists of 1694 observation data transaction days that are presented in Figure 1.

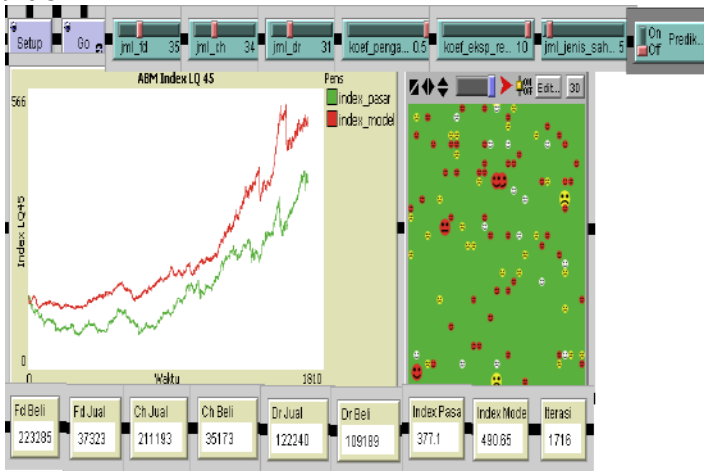


**Figure 1.**Data graphic of Index Simulation Model 2000-2006



**Figure 2.**Data graphic of Index Simulation Model 2000-2006

According to the scenario (investor composition total 30: 40: 30, influence coefficient 0,5 and coefficient risk expectation 1- 10), the iteration process produces a graph that consists Meanwhile, the iteration process of changing variations in the composition of investors, the weight of the coefficient of influence, and the weight of the risk expectation coefficient, and the number and type of share ownership were conducted repeatedly. The result is presented in Figure 3.



**Figure 3. Data graphic of Index Simulation Model 2000-2006 (Source : processed data)**

As shown in Figure 3, the green line shows the actual data LQ-45, while the red line represents the result from our model. Our model's line almost has an identical fluctuation compared to the actual data trend line after going through the iteration process manually setup the program thousands of times. This process takes place in a trial & error that reflects the model's weaknesses because there is no certainty (random) in iterations of several conditions close to the trend data patterns to the two populations converging.

Based on the iteration process, which is partly revealed in the figures, it can be summarized the results of the analysis of various model variants starting from a variant I (one) to variants of model XIII (thirteen), namely as follows: (1) the composition of investors as agents are 35 fundamental investors, with a frequency of buying transactions 223,285 times and selling transactions 37,323 times, and chartis types as many as 34 with a frequency of buying transactions 35,173 times selling transactions 211,193 times. While 31 investors

are noisy, total selling transactions carried out 122,240 times and 109,189 times buying transactions; and (2) during the model observation period, 370,756 times of selling transactions were accumulated and dominated by chartist investors. Buying transactions in the same period were 367,647 times dominated by fundamental type investors.

The coefficient of influence at position 0.5, which means the influence of agents on other agents in decision making (selling, buying, and or not active), is robust. The coefficient of risk expectation at a value of 10, which is meaningful of the total weight of investor decisions, the role of risk expectations of agents expects a negative difference situation. That is when the contract index is higher than the real index value (market price) or an out-of-the-money situation. Ownership of type and number of shares at a value of 5, which means the situation of ownership of type and number of shares by an agent or investor is relatively small when compared to the total spectrum of the value of ownership of type and number of shares which is as much as 45.

### **Discussion and conclusion**

Our research objective is to reconstruct an Agent-Based Model to predict stock price. We argue that the basic attributes (investment strategy and the power of agent's influence) and temporal attributes (capital, ownership, and risk expectation) can become predictors of the stock price. Our findings that, in general, the trend of price stock resulted from our model is identical with the trend of the stock price from real data. Therefore, it provides support for our hypothesis, stated that basic attributes and temporal attributes might become a valid predictor for the stock price. Our findings also support previous literature, which found that investment strategy [36], the power of agent's influence [24], capital, ownership [16], and risk expectation [19] is a predictor of stock price. Furthermore, the finding suggests that our model may become a robust framework to predict investment behavior, mainly reflected in stock price.

From these findings, our research may contribute in several aspects. First, for the investors, our model provides an alternative to predict the stock price by considering behavioral aspects of investors. It is essential because it can minimize the potential loss and risk of investment behavior due to an incomprehensive estimation model. Second, for scholars in investment studies, our study contributes by reconstructing an Agent-based Model. However, despite its

contributions, our paper has a limitation. The most important limitation of this study is because we used context-specific data, which is only from Indonesia. Future studies may need to replicate this study on a broader context to increase the generalizability of our model.

## References

- [1] Al Mamun, M., Syeed, M. A., & Yasmeeen, F. (2015). Are investors rational, irrational or normal?. *Journal of Economic & Financial Studies*, 3(04), 01-15.
- [2] Bollerslev, T., Chou, R. Y., & Kroner, K. F. (1992). ARCH modeling in finance: A review of the theory and empirical evidence. *Journal of econometrics*, 52(1-2), 5-59.
- [3] Bouchaud, J. P., & Potters, M. (2000). *Theory of financial risks* (Vol. 4). From Statistical Physics to Risk Management: Cambridge University Press, Cambridge.
- [4] Campbell, J. Y., Lettau, M., Malkiel, B. G., & Xu, Y. (2001). Have individual stocks become more volatile? An empirical exploration of idiosyncratic risk. *The journal of finance*, 56(1), 1-43.
- [5] Canessa, E. (2000). Multifractality in time series. *Journal of Physics A: Mathematical and General*, 33(19), 3637.
- [6] Cetin, O. L., & Baydar, C. (2004). *Agent-based modelling for optimal trading decisions*. Accenture Working Papers.
- [7] Cont, R. (2001). Empirical properties of asset returns: stylized facts and statistical issues. *Quantitative finance*, 1(2), 223.
- [8] Cont, R. (2007). Volatility clustering in financial markets: empirical facts and agent-based models. In *Long memory in economics* (pp. 289-309). Springer, Berlin, Heidelberg.
- [9] Cooper, D. R., Schindler, P. S., & Sun, J. (2006). *Business research methods* (Vol. 9, pp. 1-744). New York: Mcgraw-hill.
- [10] Cunningham, L. A. (1994). Capital Market Theory, Mandatory Disclosure, and Price Discovery. *Wash. & Lee L. Rev.*, 51, 843.
- [11] Dangl, T., Döcker, E. J., Gaunersdorfer, A., Pfister, A., Sögner, L., & Strobl, G. (2001). Adaptive erwartungsbildung und finanzmarktdynamik. *Schmalenbachs Zeitschrift für betriebswirtschaftliche Forschung*, 53(4), 339-365.
- [12] El-Yaniv, R. (1998). Competitive solutions for online financial problems. *ACM Computing Surveys (CSUR)*, 30(1), 28-69.
- [13] Farmer, J. D., & Lillo, F. (2004). On the origin of power-law tails in price fluctuations. *Quantitative Finance*, 4(1), C7.

- [14] Gabaix, X., Gopikrishnan, P., Plerou, V., & Stanley, H. E. (2003). A theory of power-law distributions in financial market fluctuations. *Nature*, 423(6937), 267-270.
- [15] Giles, C. L., Lawrence, S., & Tsoi, A. C. (2001). Noisy time series prediction using recurrent neural networks and grammatical inference. *Machine learning*, 44(1), 161-183.
- [16] Gul, F. A., Kim, J. B., & Qiu, A. A. (2010). Ownership concentration, foreign shareholding, audit quality, and stock price synchronicity: Evidence from China. *Journal of financial economics*, 95(3), 425-442.
- [17] Hull, J. C. (2003). *Options, Futures and Other Derivatives (Fifth Edition)*, Prentice-Hall Pearson Education., New Jersey.
- [18] Kim, K. J. (2003). Financial time series forecasting using support vector machines. *Neurocomputing*, 55(1-2), 307-319.
- [19] Klos, A., Weber, E. U., & Weber, M. (2005). Investment decisions and time horizon: Risk perception and risk behavior in repeated gambles. *Management Science*, 51(12), 1777-1790.
- [20] Markowitz, H. M. (1968). *Portfolio selection*. Yale university press.
- [21] Mauboussin, M. J. (2002). Revisiting market efficiency: The stock market as a complex adaptive system. *Journal of Applied Corporate Finance*, 14(4), 47-55.
- [22] Mikosch, T., & Stărică, C. (2004). Nonstationarities in financial time series, the long-range dependence, and the IGARCH effects. *Review of Economics and Statistics*, 86(1), 378-390.
- [23] Müller, U. A., Dacorogna, M. M., Davé, R. D., Olsen, R. B., Pictet, O. V., & Von Weizsäcker, J. E. (1997). Volatilities of different time resolutions—analyzing the dynamics of market components. *Journal of Empirical Finance*, 4(2-3), 213-239.
- [24] Pastore, S. , Ponta, L., & Cincotti, S. (2010). Heterogeneous information-based artificial stock market. *New Journal of Physics*, 12(5), 053035.
- [25] Poteshman, A. M. (2001). Underreaction, overreaction, and increasing misreaction to information in the options market. *The Journal of Finance*, 56(3), 851-876.
- [26] Raberto, M., Cincotti, S., Focardi, S. M., & Marchesi, M. (2001). Agent-based simulation of a financial market. *Physica A: Statistical Mechanics and its Applications*, 299(1-2), 319-327.
- [27] Sallans, B., Pfister, A., Karatzoglou, A., & Dorffner, G. (2003). Simulation and validation of an integrated markets model. *Journal of Artifical Societies and Social Simulation*, 6(4),p.1-35.



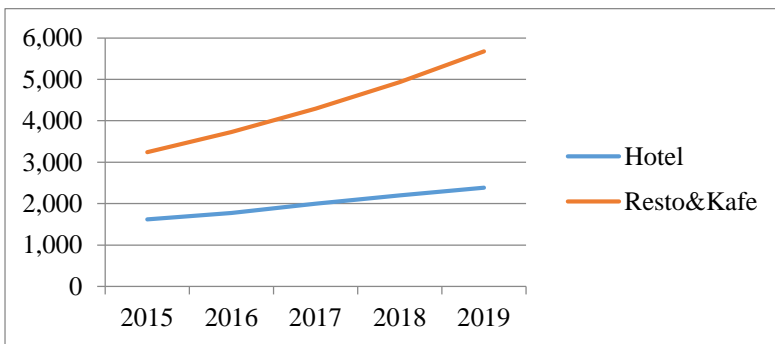
- [28] Sekaran, U. (2000). *Research Methods for Business*, New York: John Wiley & Sons, Inc.
- [29] Shiller, R. J. (2000). *Irrational Exuberance.*, Princeton University Press, Princeton.
- [30] Šperka, R., & Spišák, M. (2013). Transaction costs influence on the stability of financial market: agent-based simulation. *Journal of Business Economics and Management*, 14(sup1), S1-S12.
- [31] Srbljinović, A., & Škunca, O. (2003). An introduction to agent based modelling and simulation of social processes. *Interdisciplinary Description of Complex Systems: INDECS*, 1(1-2), 1-8.
- [32] Surya, Y., Situngkir, H., Hariadi, Y., & Suroso, R. (2004). *Aplikasi Fisika dalam Analisis Keuangan: Mekanika Statistika Interaksi Agen*. Sumber Daya MIPA.
- [33] Takahashi, H., & Terano, T. (2003). Agent-based approach to investors' behavior and asset price fluctuation in financial markets. *Journal of artificial societies and social simulation*, 6(3).
- [34] Von Neumann, J. (1981). The principles of large-scale computing machines. *Annals of the History of Computing*, 3(3), 263-273.
- [35] Waldrop, M. M. (1993). *Complexity: The emerging science at the edge of order and chaos*. Simon and Schuster.
- [36] Zhang, Y., & Li, H. (2011). Investors' risk attitudes and stock price fluctuation asymmetry. *Physica A: Statistical Mechanics and its Applications*, 390(9), 1655-1661.

# How to Increase Customer Satisfaction Based on Service Quality, Brand, And Trust in Cafe Customers?

Nurul Qomariah<sup>91</sup>, Wekel Mega Wisesa<sup>92</sup>

## Introduction

The culinary business is one of the most popular businesses among Indonesian people today. The businesses that are most in demand by the Indonesian people are very diverse including: restaurants, depots, stalls, cafes, etc. A cafe is a form of informal restaurant that emphasizes on providing a comfortable place to relax, rest, and talk while enjoying coffee or tea and other light dishes. Figure 1 shows the growth of HOREKA (Hotels, Restaurants and Cafes) in Indonesia from 2015 to 2019:



In Figure 1, it can be seen that the growth of cafe business in Indonesia is increasing rapidly. With the increasing number of hotels, restaurants, and cafes operating in the community, this will trigger the emergence of separate competition among business people in this field. Strategies to win the competition must be implemented so that the hotel, resort and cafe business can survive. There are things that need attention in running a business in the service sector. This hotel, restaurant and cafe business is a business in the service sector. One thing to note is customer satisfaction. Customer satisfaction is an important factor for service business owners to pay attention to and in order to continue to compete with competitors in similar business fields. This is because satisfaction is the feeling of consumers for the

<sup>91</sup> Universitas Muhammadiyah Jember,, [nurulqomariah@unmuhjember.ac.id](mailto:nurulqomariah@unmuhjember.ac.id)

<sup>92</sup> Universitas Muhammadiyah Jember, [wekelmegawisesa20@gmail.com](mailto:wekelmegawisesa20@gmail.com)

services they have received [1]. Satisfied consumers will provide good information and will recommend to others. To be able to get consumer satisfaction, one of them is to provide good service quality, attractive brands and trust that is continuously maintained so that consumers feel comfortable in enjoying every product offered by service providers.

Consumer satisfaction is a person's feelings of pleasure or disappointment that arise after comparing the performance of the product thought to the expected performance [1]. [2] states that consumer satisfaction is a situation shown by consumers when they realize that their needs and desires are as expected and well fulfilled. According to [3], satisfaction is influenced by the comparison of perceived services with expected services, and according to consumers' short-term emotional reactions to the performance of certain services.

Service quality is the level of expected and control or the level of excellence to meet consumer desires [4]. [5] states that quality as interpreted by ISO 9000 is a combination of properties and characteristics that determine the extent to which the output can meet the requirements of consumer needs. consumers who determine and assess to what extent these traits and characteristics meet their needs. According to [6], a brand is a name, term, sign, symbol, or design or a combination of these that identifies the product or service of one seller or group of sellers and differentiates that product from competitors' products.

Research [7], [8], [9], [10], [11], [12], [13], [14], [15], [16], [17], [18], [19], [20], [21], [22], [23], [24], [25], [26], [27], [28], [29], [30],[31], [32], states that service quality affects customer satisfaction. Research [33] states that service quality has no effect on customer satisfaction. Based on previous research that has been done by researchers, the hypotheses in this study:

H1: Service quality has a significant positive effect on customer satisfaction.

A brand is a name, term, sign, symbol or design, or a combination of them, intended to identify the goods or services of one seller or group of sellers and to differentiate them from those of competitors [2]. According [3], a brand is a logo, legal instrument (ownership rights), company, shorthand notation, risk reducer, positioning, personality, value chain, vision, value adder, identity, image, relationship and evolving entity. Based on the definition of a brand that has been presented, it can be concluded that a brand is a

symbol, letters that can be read and certain specific colors that make it easier for consumers to remember a product and can distinguish similar products from competing products. A brand is actually a seller's promise to consistently provide certain features, benefits, and services to buyers. The best brands provide quality assurance. Consumer satisfaction is a person's feelings of pleasure or disappointment that arise after comparing the performance of the product thought to the expected performance [1]. Well-known brands are usually already attached to the hearts of customers and have been proven to be able to provide their own satisfaction for customers. Therefore, the service provider must maintain a well-known brand by providing the best quality and service for customers.

Research [34], [35], [36], [37], [38], [39], [40], [41], [42], [43], [44], [45], [32], [46], [47], [48], [34], [40], [41], [39], [38], [49], [37], [30], [50], [46] states that the brand of a product can increase customer satisfaction. Based on previous research that has been done by many previous researchers, the hypotheses in this research are:

H2: Brand has a significant positive effect on consumer satisfaction.

[51] defines trust as a person's willingness to be sensitive to the actions of others based on the expectation that others will take certain actions on people who believe in them, regardless of their ability to monitor and control them. [52] defines consumer trust as all knowledge owned by consumers and all conclusions made by consumers about objects, attributes and benefits. Building a relationship in business requires trust between business people and their consumers, there needs to be trust to maintain long-term relationships between producers and consumers in order to create loyalty for consumers. Trust cannot just arise from within the consumer, but trust arises because it is built from the beginning of the transaction and is proven by the results given by the producer of the desires expected by the consumer. According to [3], satisfaction is influenced by the comparison of perceived services with expected services, and according to consumers' short-term emotional reactions to the performance of certain services.

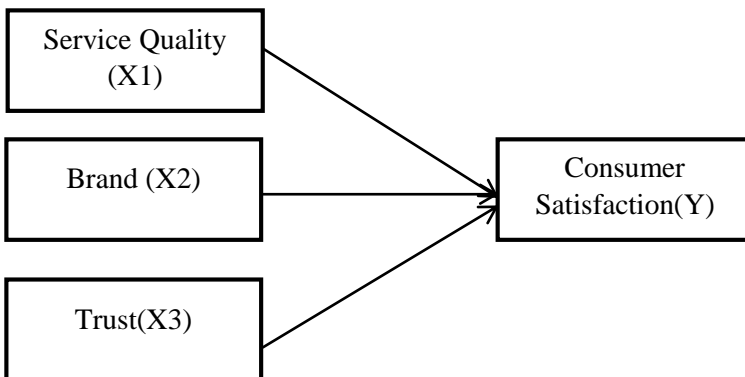
Research [51] stated that trust has significant and positive impact to consumer's satisfaction, with t-value 4.97. [53], [54], [55], [56], [57], [58], [58], [59] stated that trust has significant influence to the customer satisfaction. Research [60], stated that partially trust has no significant effect on customer satisfaction. Based on previous

research that has been done by many previous researchers, the hypotheses in this research are:

H3: Trust has a significant positive effect on consumer satisfaction.

This study has three research questions, namely: first, does service quality affect customer satisfaction? Second, does the brand affect customer satisfaction? Finally, does trust affect customer satisfaction at Kafe Kolong Jember? This research has three objectives. The first objective is to determine the effect of service quality on customer satisfaction. Second, to determine the effect of brand on customer satisfaction. Third, to determine the effect of trust on customer satisfaction. This research contributes to the marketing management literature that focuses on improving the relationship between service quality, brand and trust with customer satisfaction. This research also contributes to the food and beverage industry in the form of a cafe business which is currently trending in the community.

**Figure 2: Research Conceptual Framework**



as conducted at the Kolong Cafe in Jember Regency. Actually there are many cafes in Jember Regency, such as: 14 Mili Café, Root Cafe, My Sister Café, Brother Coffee and Bar, Radio Kafe, Grand Kafe, Hi Hi Cafe, Kontjo Lawas, Anglo Saxon Café, Coffee Toffe Jember, Koplak Kafe, Excelso Coffee Jember, Thin Thin Cafe, Do Kafe, Macapat Kafe, Colony Cafe, Cak Wang. Kafe Kolong was chosen as the research site because Kafe Kolong has its own characteristics that attract customers, namely the location of Kafe Kolong which is under the bridge.

In determining the sample, the sampling procedure used is purposive sampling, namely the determination of samples of respondents who at the time of distributing the questionnaire were at the Kolong Jember Cafe and were making purchases with the following criteria:

1. Consumers who are used as respondents are at least 18 years old, at which age they can assess the quality of service at Kafe Kolong Jember.
2. Consumers who have made purchases at the Kolong Jember Cafe.

According to [61] suggesting the number of samples is the same sample as the number of indicators as many as 15 indicators multiplied by 5 parameters up to 10 parameters. The number of samples in this study was set at 75 respondents, obtained from the total number of indicator variables used in this study, 15 indicators multiplied by 5 parameters ( $15 \times 5 = 75$ ).

This study uses three independent variables, namely: service quality, brand and trust, and one dependent variable, namely consumer satisfaction. Each variable has an indicator that will be used as a measuring tool in the form of a questionnaire. Dimensions, number of indicators and their sources are presented in Table 1.

**Table 1: Number of Research Indicators**

Dimension	No of items	Source
Service Quality	5	[62]
Brand	4	[2]
Trust	3	[56]
Satisfaction	3	[4]

Descriptive analysis is used to provide an overview of a data so that the data becomes easy to understand. Descriptive analysis is used to determine the public's perception of a certain thing. With this analysis, the trend of research findings will be known, whether they fall into the low, medium or high category. The description that will be described is about the respondent's data and the description of the research variables.

Validity test and reliability test were used to measure the research measuring instrument in the form of a questionnaire. Validity test is used to determine the extent to which the validity of the data obtained from the questionnaire distribution. The validity test criteria is carried out by testing the significant level of Pearson's product moment, with a significance value of  $<5\%$ . The data reliability

test is carried out to determine the ability of a measurement result to be relatively consistent, if it is consistent if the measurement is repeated two or more times [63]. Reliability criteria were carried out by testing the Cronbach Alpha statistic  $> 0.60$ . Multiple linear regression analysis using the latest SPSS was used to determine the effect of the independent variables (service quality, brand, trust) on the dependent variable (consumer satisfaction) [64]. The regression equation model used can be formulated as follows:  $Y = a + b_1X_1 + b_2X_2 + b_3X_3 + e$ .

## Discussion

Statistical descriptions of respondents related to gender, age and education are presented in Table 2.

**Table 2: Descriptive Statistical Analysis Results**

Variable	Percentage
<b>Sex</b>	
Male	68
Female	32
<b>Age in years</b>	
18 – 25	54
26 – 33	20
34 – 41	16
42 – 49	10
<b>Education</b>	
High School	16
Diploma	21
Bachelor	52
Postgraduate	11

The results of statistical calculations for the validity test show that the correlation between each variable indicator of service quality (X1), brand (X2), trust (X3), and consumer satisfaction (Y) shows that  $R_{count} > R_{table}$  and  $Sig < 0.05$ . It can be concluded that all question items for service quality (X1), brand (X2), trust (X3), and consumer satisfaction (Y) variables are declared valid (refer Table.3).

**Table 3: Validity Test Results**

Variable	Item	$R_{table}$	$R_{count}$	Sig.	Information
Service Quality (X <sub>1</sub> )	X1.1	0,227	0,558	0,000	Valid
	X1.2	0,227	0,605	0,000	Valid

Brand(X <sub>2</sub> )	X1.3	0,227	0,811	0,00 0	Valid
	X1.4	0,227	0,678	0,00 0	Valid
	X1.5	0,227	0,555	0,00 0	Valid
	X2.1	0,227	0,746	0,00 0	Valid
	X2.2	0,227	0,721	0,00 0	Valid
	X2.3	0,227	0,628	0,00 0	Valid
	X2.4	0,227	0,579	0,00 0	Valid
Trust(X <sub>3</sub> )	X3.1	0,227	0,565	0,00 0	Valid
	X3.2	0,227	0,692	0,00 0	Valid
	X3.3	0,227	0,707	0,00 0	Valid
Consumer Satisfaction (Y)	Y.1	0,227	0,689	0,00 0	Valid
	Y.2	0,227	0,858	0,00 0	Valid
	Y.3	0,227	0,705	0,00 0	Valid

Reliability measurement is done by testing the Cronbach Alpha statistic. A variable is said to be reliable if it gives a Cronbach Alpha value > 0.60 [63]. The results of the calculation of reliability testing on service quality (X<sub>1</sub>), brand (X<sub>2</sub>), trust (X<sub>3</sub>), and consumer satisfaction (Y) instruments obtained Cronbach's Alpha or r alpha values above 0.60. This proves that the research instrument in the form of a questionnaire is reliable because r alpha is greater than 0.60 (refer Table 4).

**Table 4: Reliability Test Results**

Variable	Cronbach's Alpha if item deleted	Reliability Standard	Information
Service Quality (X <sub>1</sub> )	0,757	0,60	Reliable
Brand (X <sub>2</sub> )	0,756	0,60	Reliable
Trust (X <sub>3</sub> )	0,741	0,60	Reliable



Consumer Satisfaction (Y)	0,799	0,60	Reliable
---------------------------	-------	------	----------

The results of multiple linear regression analysis that have been analyzed with the latest version of SPSS software produce regression constants and coefficients for each variable of service quality (X1), brand (X2), trust (X3). The results of multiple linear regression calculations obtained multiple linear regression equations as follows:  $Y = 0.506 + 0.158X_1 + 0.254X_2 + 0.432X_3 + e$  (refer Table 5).

**Table 5: Regression Coefficient**

Variable	Regression Coefficient	Significance Level	Information
Constant	0,506	-	Significant
Service Quality (X <sub>1</sub> )	0,158	0,013	Significant
Brand (X <sub>2</sub> )	0,254	0,011	Significant
Trust (X <sub>3</sub> )	0,432	0,006	Significant

Hypothesis testing is carried out to test the stated hypothesis. Hypothesis testing is done by t-test, namely partial testing. This test is conducted to determine whether the independent variables individually affect the dependent variable. As for the significance of the terms of acceptance or rejection if the significant number is below or equal to 0.05 then the alternative hypothesis is accepted and H<sub>0</sub> is rejected. The results of the t test are presented in Table 6.

**Table 6: Hypothesis Test Results**

Variable	t <sub>table</sub>	t <sub>count</sub>	Sig.	Information
Service Quality (X <sub>1</sub> )	1,665	2,538	0,013	H <sub>0</sub> rejected
Brand (X <sub>2</sub> )	1,665	2,628	0,011	H <sub>0</sub> rejected
Trust (X <sub>3</sub> )	1,665	2,858	0,006	H <sub>0</sub> rejected

### **The Effect of Service Quality on Consumer Satisfaction**

The results of statistical analysis show that the regression coefficient of the service quality variable is 0.158 with a significance level of 0.013 and the t count of 2.538 is greater than the t table of 1.665. Based on these calculations, the hypothesis which states that service quality affects consumer satisfaction is accepted. Thus the

quality of services provided by Kafe Kolong Jember in the form of the place and location of the cafe, accuracy of service delivery, responsiveness of cafe employees, guarantee of quality products and services can provide satisfaction to cafe customers.

According to [65] service quality is the expected level and control or level of excellence to meet consumer desires. According to [5] said quality is a combination of properties and characteristics that determine the extent to which the output can meet the requirements of consumer needs. Consumers who determine and assess to what extent these traits and characteristics meet their needs. In carrying out the company's strategy, it cannot be separated from creating the quality of services provided to consumers. If the quality of service increases, then customer satisfaction will increase as well. Service quality has a close relationship with customer satisfaction. Service quality gives consumers the impetus to forge strong relationships with the company. It can be said that a service is prepared by consumers from its quality. Therefore, service quality will affect the level of satisfaction felt by consumers. This feeling of satisfaction drives consumers to establish a strong relationship with the company. In a certain period of time, the relationship will create loyalty in consumers.

The results of this study are in line with previous research conducted which states that service quality has a significant effect on consumer satisfaction. Research that also links service quality with customer satisfaction includes: [46], [43], [44], [66], [45], [24], [16], [67], [15], [21], [7], [17], [13], [23], [11], [22], [29], [68].

### **The Effect of Brand on Consumer Satisfaction**

The results of statistical analysis show that the regression coefficient of the brand variable is 0.254 with a significance level of 0.011 and the t count of 2.628 is greater than the t table of 1.665. Based on these calculations, the hypothesis which states that the brand affects consumer satisfaction is accepted. Thus the brand created by Kafe Kolong Jember in the form of brand awareness, brand association, brand loyalty can provide satisfaction to cafe customers.

Brand equity is the added value given to products and services. Brand equity can be reflected in the way consumers think, feel, and act in relation to the brand, as well as in the price, market share, and profitability that brands provide to companies [2]. Brand equity is the value directly or indirectly owned by the brand. Brand equity is the strength of a brand that promises the value expected by

consumers for a product that results in more satisfaction than other products [5]. Brand equity is a set of brand assets and liabilities associated with a brand, name, symbol, which can increase or decrease the value provided by a product or service both to the company and its consumers. Thus, it can be concluded that brand equity is the strength of a brand that promises the value expected by consumers for a product so that other products can be purchased. Brand equity can provide value and benefits, both for consumers and for companies. Brand equity is an asset that can provide its own value in the eyes of consumers, the assets it contains can help consumers in interpreting. Process, and store information related to these products and brands. Brand equity can affect consumer confidence in making purchasing decisions on the basis of past experience in use or proximity, associations with various brand characteristics.

The results of this study are in line with previous research conducted by [38] which states that the brand has an effect on consumer satisfaction of Canon DSLR cameras. Research [39] which argues that the brand has an effect on consumer satisfaction Starbucks Coffee in Taiwan. Research that also links brand image with customer satisfaction includes: [42], [44], [66], [31], [69], [33], [46], [43], [11], [23], [24], [30], [48], [49], [37], [41], [40], [34], [70].

### **The Effect of Trust on Consumer Satisfaction**

The results of statistical analysis show that the regression coefficient of the brand variable is 0.432 with a significance level of 0.006 and the t count of 2.858 is greater than the t table of 1.665. Based on these calculations, the hypothesis which states that trust has an effect on consumer satisfaction is accepted. Thus the trust that has been built and developed by Kafe Kolong Jember in the form of: the ability to provide good service, integrity of employees, and the kindness of employees can provide satisfaction to cafe customers.

Trust is the most important thing in the occurrence of a buying and selling transaction, both for products and also for services. Building a relationship in business requires trust between business people and their consumers, there needs to be trust to maintain long-term relationships between producers and consumers in order to create loyalty for consumers. Trust cannot just arise from within the consumer, but trust arises because it is built from the beginning of the transaction and is proven by the results given by the producer of the desires expected by the consumer. [56] states that trust is a person's willingness to be sensitive to the actions of others based on the

expectation that others will take certain actions on people who believe in them, regardless of their ability to monitor and control them. Trust is the belief that someone's word or promise can be trusted and someone will fulfill his obligations in an exchange relationship [57]. Trust relates to the company's intention to rely on their exchange partners. Trust arises when those involved have received certainty from the other party, and are willing and able to fulfill their obligations. Based on the explanation above, it can be concluded that trust is a belief in the goodness of other individuals or groups to carry out their duties and obligations for the common good.

A person looks for products and services that will solve problems in meeting his needs. Beliefs, attitudes, and behaviors are formed in two different ways. In the direct formulation, beliefs, attitudes, and behaviors are created without any other circumstances occurring before. Thus, as the behavioral influence perspective shows, behavior can occur without the formation of a strong initial attitude or consumer belief about the object to which the behavior is directed. Likewise, as the experiential perspective suggests attitudes (eg, feelings) can be created without the initial development of consumers' specific beliefs about the attitude [71]. Once a belief, attitude, or behavior is directly formed, there is a tendency for the three states to create a hierarchy. In this way, consumers first form trust in a product and then form beliefs and attitudes towards the product.

The results of this study are in line with previous research conducted [72] which states that trust has an effect on consumer satisfaction. Research [55] states that customer trust gives significant and positive influence to the customer satisfaction on E-commerce and online shopping transactions. Research [54], states that trust has an effect on Shopee e-commerce consumer satisfaction. Other studies that also discuss the relationship between trust and satisfaction include: [42]. [23], [60].

## **Conclusions and Suggestions**

The conclusions in this study will be described based on the results of the analysis and discussion that have been described previously, namely: (1) the quality of services provided by Kafe Kolong can provide satisfaction to consumers. Physical evidence in the form of a place to hang out, the reliability of employees in serving, responses from employees in receiving input, guarantees for the quality of the products provided and empathy from the employees are able to provide a level of satisfaction to consumers. From the results

of this study, the better the quality of the services provided, the higher the customer satisfaction; (2) the brand has an effect on consumer satisfaction at Kafe Kolong Jember. The better the brand of the product or service it will give confidence to consumers which can ultimately provide satisfaction to consumers; (3) trust has a positive and significant effect on consumer satisfaction at the Kolong Jember Cafe. The higher the public trust in the product or service, the more satisfaction felt by consumers. The trust that has been given by consumers must continue to be maintained by the service provider. Consumer trust should not be tarnished by trivial things, because once the trust that has been given is tarnished, consumers will be disappointed and will reduce customer satisfaction.

Based on the results of research and discussion in this study, several suggestions can be put forward, namely: (1) for cafe business people it is better for physical evidence of a cafe place to be adjusted to the desires and needs of current consumers; (2) for future researchers, it is better if the questionnaires are distributed using technology through questionnaires with link.bit.ly to be more time efficient and paperless; (3) for further researchers, it is recommended to use variables other than the variables that have been used in order to provide satisfaction to consumers who like to hang out in cafes. ; (4) For respondents, this research is expected to be able to provide knowledge about the influence of service quality, brand, and trust on consumer satisfaction in cafes so that respondents are able to have good knowledge when they want to use cafes as a place to relax and hang out.

## References

- [1] N. Qomariah, *Marketing Adactive Strategy*. Jember: Cahaya Ilmu, 2016.
- [2] P. Kotler and K. L. Keller, *Marketing Management 15e*. New Jersey: Person Prentice Hall, Inc., 2016.
- [3] F. Tjiptono, *Service Management Mewujudkan Layanan Prima. Edisi 2*. Yogyakarta: Andi, 2011.
- [4] F. Tjiptono, *Strategi Pemasaran*. Yogyakarta: Andi, 2011.
- [5] R. Lupiyoadi, *Manajemen Pemasaran*. Jakarta: Salemba Empat, 2013.
- [6] P. Kotler, *Marketing an Introducing Twelfth Edition*. England: Pearson Education, Inc., 2015.
- [7] N. Qomariah, "Pengaruh Kualitas Pelayanan Terhadap Kepuasan dan Loyalitas Pelanggan:(Studi kasus pada Universitas

- Muhamadiyah Jember),” Universitas Jember, 2008.
- [8] Subagiyo, “Pengaruh Kualitas Pelayanan Akademik Dan Citra Institusi Terhadap Kepuasan Mahasiswa Lp3I Cilegon,” *J. Lentera Bisnis*, vol. 4, no. 1, pp. 1–26, 2015.
- [9] D. Ratnasari and T. A. Gumanti, “Relationship marketing, service quality, satisfaction and customers loyalty of bank sharia mandiri banyuwangi,” *Int. J. Sci. Technol. Res.*, vol. 8, no. 6, pp. 7–10, 2019.
- [10] S. Purnomo and N. Qomariah, “Improve Community Satisfaction and Trust in the Public Service Mal of Banyuwangi District,” in *Proceeding CelSciTech UMRI 2019*, 2019, vol. 4, pp. 40–47.
- [11] W. A. Setyawati, M. Rifai, and C. Sasmito, “Pengaruh Kualitas Pelayanan , Fasilitas , Harga dan Citra Institusi Terhadap Kepuasan Pasien,,” *Madani, J. Polit. dan Sos. kemasyarakatan*, vol. 10, no. 2, pp. 50–63, 2018.
- [12] D. Yulisetiari and Y. A. Prahasta, “The effect of price, service quality, customer value, and brand image on customers satisfaction of telkomsel cellular operators in east Java Indonesia,” *Int. J. Sci. Technol. Res.*, vol. 8, no. 3, pp. 5–9, 2019.
- [13] V. Ariska, N. Qomariah, and B. Wijayanti, “The impact of service quality, price, products, and trust on ‘kober mie setan’ consumer satisfaction,” *Int. J. Sci. Technol. Res.*, vol. 9, no. 4, pp. 1782–1785, 2020.
- [14] Nursaid, S. H. Purnomo, and N. Qomariah, “The Impact of Service Quality and Institutional Image on the Satisfaction and Loyalty of Master of Management Students,” in *1st Borobudur International Symposium on Humanities, Economics and Social Sciences (BIS-HESS 2019)*, 2020, vol. 436, pp. 156–161, doi: 10.2991/assehr.k.200529.033.
- [15] A. Setiawan, N. Qomariah, and H. Hermawan, “Pengaruh Kualitas Pelayanan Terhadap Kepuasan Konsumen,” in *Jurnal Sains Manajemen dan Bisnis Indonesia*, 2019, vol. 9, no. 2, pp. 114–126, doi: <http://dx.doi.org/10.32528/jsmbi.v9i2.2819>.
- [16] R. Anggriana, N. Qomariah, and B. Santoso, “Pengaruh Harga, Promosi, Kualitas Layanan Terhadap Kepuasan Pelanggan Jasa Ojek Online ‘OM-JEK’ Jember,” *J. Sains Manaj. dan Bisnis Indones.*, vol. 7, no. 2, pp. 137–156, 2017.
- [17] M. M. Yanuar, N. Qomariah, and B. Santoso, “Dampak kualitas produk, harga, promosi dan kualitas pelayanan terhadap kepuasan pelanggan Optik Marlin cabang Jember,” *J. Manaj. dan Bisnis Indones.*, vol. 3, no. 1, pp. 61–80, 2017.

- [18] D. Lie, A. Sudirman, E. Efendi, and M. Butarbutar, "Analysis of mediation effect of consumer satisfaction on the effect of service quality, price and consumer trust on consumer loyalty," *Int. J. Sci. Technol. Res.*, vol. 8, no. 8, pp. 421–428, 2019.
- [19] D. D. Rahayu, "Analysis of customer satisfaction level on service quality of three-star hotel in Pekanbaru," *Int. J. Sci. Technol. Res.*, vol. 8, no. 10, pp. 592–598, 2019.
- [20] R. I. Verriana and M. Y. Anshori, "Pengaruh Kualitas Layanan ( Service Quality ) Terhadap Loyalitas Melalui Kepuasan," *Account. Manag. J.*, vol. 1, no. 1, pp. 63–79, 2017.
- [21] E. Soliha, A. Rizal, A. Maskur, N. B. Mawarni, and R. Rochmani, "Service quality, bank image, and customer loyalty: The mediating role of customer satisfaction," *Int. J. Sci. Technol. Res.*, vol. 8, no. 10, pp. 2667–2671, 2019.
- [22] M. Maskur, N. Qomariah, and Nursaidah, "Analisis Pengaruh Kualitas Pelayanan, Harga, Dan Kepuasan Pelanggan Terhadap Loyalitas Pelanggan (Studi Kasus pada Bengkel Mobil Larasati Lumajang)," *J. Sains Manaj. Bisnis Indones.*, vol. VI, no. 2, pp. 212–221, 2016.
- [23] Sutrisno, D. Cahyono, and N. Qomariah, "ANALISIS KUALITAS PELAYANAN , KEPERCAYAAN SERTA CITRA KOPERASI TERHADAP KEPUASAN DAN LOYALITAS ANGGOTA," *J. Sains Manaj. Bisnis Indones.*, vol. 7, no. 2, pp. 157–174, 2017.
- [24] N. Qomariah, A. Budiastuti, A. Sanosra, A. Susbiani, and E. Budisatoto, "Building Student Satisfaction and Loyalty Based on Service Quality and Institutional Image," *SSRG Int. J. Econ. Manag. Stud.*, vol. 7, no. 9, pp. 24–33, 2020.
- [25] N. K. Aliman and W. N. Mohamad, "Linking Service Quality, Patients' Satisfaction and Behavioral Intentions: An Investigation on Private Healthcare in Malaysia," *Procedia - Soc. Behav. Sci.*, vol. 224, no. August 2015, pp. 141–148, 2016, doi: 10.1016/j.sbspro.2016.05.419.
- [26] R. Samal and S. K. Pradhan, "Service Quality, Customer Satisfaction and Loyalty: An Empirical Analysis of Public Sector Banks in Bhubaneswar," *Siddhant- A J. Decis. Mak.*, vol. 14, no. 2, p. 97, 2014, doi: 10.5958/2231-0657.2014.00512.6.
- [27] W. M. Lassar, C. Manolis, and R. D. Winsor, "Service quality perspectives and satisfaction in private banking," *Int. J. Bank Mark.*, vol. 18, no. 4, pp. 181–199, 2000, doi: 10.1108/02652320010349067.
- [28] Y. Jiang and C. Wang, "The impact of affect on service quality and

- satisfaction: The moderation of service contexts," *J. Serv. Mark.*, vol. 20, no. 4, pp. 211–218, 2006, doi: 10.1108/08876040610674562.
- [29] N. Qomariah, A. Fahrurrozi, and Y. Rozzaid, "Efforts to Increase Retail Customer Satisfaction," *Int. J. Econ. Manag. Stud.*, vol. 7, no. 7, pp. 25–31, 2020.
- [30] R. Chao, T.-C. Wu, and W.-T. Yen, "The Influence of Service Quality , Brand Image , and Customer Satisfaction on Customer Loyalty for Private Karaoke Rooms in Taiwan," *J. Glob. Bus. Manag.*, vol. 11, no. 1, pp. 59–67, 2015.
- [31] I. K. Subagja and P. H. Susanto, "Pengaruh Kualitas Pelayanan, Kepuasan Nasabah Dan Citra Perusahaan Terhadap Loyalitas Nasabah Pt. Bank Central Asia Tbk Kantor Cabang Pondok Gede Plaza," *J. Manaj. Bisnis Krisnadwipayana*, vol. 7, no. 1, pp. 69–84, 2019, doi: 10.35137/jmbk.v7i1.249.
- [32] M. Mutmainnah, "Pengaruh Kualitas Layanan Dan Citra Perusahaan Terhadap Kepuasan Dan Loyalitas Nasabah," *J. Manaj. dan Pemasar. Jasa*, vol. 10, no. 2, p. 201, 2018, doi: 10.25105/jmpj.v10i2.2344.
- [33] N. Qomariah, "Pengaruh Kualitas Layanan dan Citra Institusi Terhadap Kepuasan dan Loyalitas Pelanggan," *J. Apl. Manaj.*, vol. 10, no. 1, pp. 177–187, 2012.
- [34] C. chan Wu, "The impact of hospital brand image on service quality, patient satisfaction and loyalty," *African J. Bus. Manag.*, vol. 5, no. 12, pp. 4873–4882, 2011, doi: 10.5897/AJBM10.1347.
- [35] N. Qomariah, *PENTINGNYA KEPUASAN DAN LOYALITAS PENGUNJUNG (Studi Pengaruh Customer Value, Brand Image dan Atribut Produk Terhadap Kepuasan dan Loyalitas Pengunjung Pariwisata Pantai)*. Jember: Pustaka Abadi, 2020.
- [36] A. Fahmi and D. Hands, "The Taxi Service Review: Malaysia Context," *Mediterr. J. Soc. Sci. MCSER Publ.*, vol. 7, no. 4, pp. 2039–9340, 2016, doi: 10.5901/mjss.2016.v7n4p.
- [37] G. Kavengi, "The Impact of Bank Brand Image on Customer Satisfaction and Loyalty : A Case of Kenya Commercial Bank," *Eur. J. Bus. Manag.*, vol. 5, no. 21, pp. 35–40, 2013.
- [38] P. Pusparani and N. Rastini, "Pengaruh Kualitas Produk Dan Brand Image Terhadap Kepuasan Konsumen Dan Loyalitas Pelanggan Kamera Canon Digital Single Lens Reflex (Dslr) Di Kota Denpasar," *E-Jurnal Manaj. Univ. Udayana*, vol. 3, no. 5, p. 255333, 2014.
- [39] T. Y. Tu, C. M. Wang, and . H.-C. C., "Corporate Brand Image and



- Customer Satisfaction on Loyalty: An Empirical Study of Starbucks Coffee in Taiwan," *J. Soc. Dev. Sci.*, vol. 3, no. 1, pp. 24–32, 2012, doi: 10.22610/jsds.v3i1.682.
- [40] S. L. S. Jr, M. W. Omar, and N. A. Wahid, "the Effect of Brand Image on Overall Satisfaction and Loyalty Intention in the Context of Color Cosmetic," *Yin Yang Csr Ethical Brand.*, vol. 12, no. 1, pp. 83–100, 2007.
- [41] R. Neupane, "The Effects of Brand Image on Customer Satisfaction and Loyalty Intention in Retail Super Market Chain UK," *Int. J. Soc. Sci. Manag.*, vol. 2, no. 1, pp. 9–26, 2015, doi: 10.3126/ijssm.v2i1.11814.
- [42] E. Usvela, N. Qomariah, and Y. G. Wibowo, "Pengaruh Brand Image , Kepercayaan , Dan Nilai Pelanggan Terhadap Kepuasan Pelanggan Herbalife," *J. Manaj. dan Bisnis Indoensia*, vol. 5, no. 2, pp. 300–312, 2019, doi: <https://doi.org/10.32528/jmbi.v5i2.2930>.
- [43] S. Y. Atmanegara, D. Cahyono, N. Qomariah, and A. Sanosra, "Pengaruh Kualitas Pelayanan , Citra Perusahaan , dan Lokasi Terhadap Kepuasan Konsumen Hotel Ijen View Bondowoso," *J. Sains Manaj. dan Bisnis Indonessia, E-ISSN 2541-2566*, vol. 9, no. 1, pp. 79–89, 2019.
- [44] N. Nursaid, S. H. Purnomo, and N. Qomariah, "The Impact of Service Quality and Institutional Image on the Satisfaction and Loyalty of Master of Management Students," in *1st Borobudur International Symposium on Humanities, Economics and Social Sciences (BIS-HESS 2019, 2020)*, vol. 436, pp. 156–161, doi: 10.2991/assehr.k.200529.033.
- [45] A. Muzammil, M. Yunus, and N. Darsono, "Pengaruh Kualitas Pelayanan Dan Citra Perusahaan Terhadap Loyalitas Pelanggan Indihome Pt. Telkom Indonesia Di Banda Aceh Dengan Kepuasan Dan Kepercayaan Pelanggan Sebagai Variabel Mediasi," *J. Manaj. dan Inov.*, vol. 8, no. 3, pp. 104–133, 2017.
- [46] A. Djanas, "Kualitas Pelayanan dan Citra Perusahaan terhadap Kepuasan Serta dampaknya terhadap Loyalitas Wisatawan," *JSM (Jurnal Sains Manajemen) Progr.*, vol. V, no. 2, pp. 184–192, 2016.
- [47] N. Qomariah, "Impact of Customer Value, Brand Image and Product Attributes to Satisfaction and Loyalty Tourism Visitors in Jember Regency," *Mediterr. J. Soc. Sci.*, vol. 8, no. 5–1, pp. 129–135, 2018, doi: 10.2478/mjss-2018-0105.
- [48] H. Saleem and N. S. Raja, "The impact of service quality on customer satisfaction, customer loyalty and brand image:

- Evidence from hotel industry of Pakistan,” *Middle - East J. Sci. Res.*, vol. 19, no. 5, pp. 706–711, 2014, doi: 10.5829/idosi.mejsr.2014.19.5.21018.
- [49] N. K. Upamannyu, “Effect of Brand Image on Customer Satisfaction & Loyalty Intention and the Role of Customer Satisfaction Between Brand Image and Loyalty Intention: a Study in Context of Cosmetic Product,” *J. Soc. Sci. Res.*, vol. 3, no. 2, pp. 274–285, 2014, doi: 10.24297/jssr.v3i2.3119.
- [50] S. A. Dewi and Rulirianto, “PENGARUH CITRA PERUSAHAAN, KEPERCAYAAN PELANGGAN, DAN KUALITAS PELAYANAN TERHADAP LOYALITAS PELANGGAN PT BUANA LANGGENG JAYA TULUNGAGUNG Shinthya,” *J A B J. Apl. Bisnis*, pp. 244–249, 2011.
- [51] T. Hendratono, “PENGARUH TRUST DAN LINGKUNGAN FISIK TERHADAP KEPUASAN PELANGGAN,” *J. Ilm. Hosp.*, vol. 1, no. 2, pp. 1–18, 2011.
- [52] Sunarto, *Pengantar Manajemen*. Bandung: Alfabeta, 2006.
- [53] S. Wulandari and S. Suwitho, “PENGARUH KEPERCAYAAN DAN KUALITAS LAYANAN TERHADAP KEPUASAN KONSUMEN ASURANSI JIWA,” *J. Ilmu dan Ris. Manaj.*, vol. 6, no. September, 2017.
- [54] N. Latifah, A. Widayani, R. A. Normawati, P. Studi, A. Kekhususan, and O. Perkantoran, “Manajemen PENGARUH PERCEIVED USEFULNESS DAN TRUST TERHADAP KEPUASAN KONSUMEN PADA E - COMMERCE SHOPEE,” *Bisma J. Bisnis dan Manaj. p-ISSN 1978-3108, e-ISSN 2623-0879 Vol. 14 No. 1 , 2020, Hal. 82 - 91 Bisma*, vol. 14, no. 1, pp. 82–91, 2020.
- [55] A. Andhini and Khuzaini, “PENGARUH TRANSAKSI ONLINE SHOPPING, DAN KEPERCAYAAN KONSUMEN TERHADAP KEPUASAN KONSUMEN PADA E-COMMERCE,” *J. Ilmu dan Ris. Manaj.*, vol. 6, no. 7, 2017.
- [56] K. Putra and R. Indriyani, “PENGARUH KEPERCAYAAN PELANGGAN TERHADAP KEPUASAN PELANGGAN CV MITRA PERKASA UTOMO,” *Agora*, vol. 7, no. 1, 2018.
- [57] M. Kartika and R. L. Ganarsih, “ANALISIS E-WOM, ONLINE SHOPPING EXPERIENCE DAN TRUST TERHADAP KEPUTUSAN PEMBELIAN DAN KEPUASAN KONSUMEN E-COMMERCE SHOPEE PADA MAHASISWA PASCASARJANA UNIVERSITAS RIAU,” *J. TEPAK Manaj. BISNIS*, vol. XI, no. 2, pp. 289–307, 2019.
- [58] S. Arifin, “Pengaruh Kepercayaan, Fasilitas Dan Kualitas Pelayanan Terhadap Kepuasan Konsumen Pada Hotel Jepara

- Indah," *68 J. Din. Ekon. BISNIS*, vol. 8, no. 1, pp. 67–78, 2011, doi: <https://doi.org/10.34001/jdeb.v8i1.101>.
- [59] H. Setiawan, M. M. Minarsih, and A. Fathon, "Pengaruh Kualitas Produk, Kualitas Pelayanan Dan Kepercayaan Terhadap Kepuasan Nasabah Dan Loyalitas Nasabah Dengan Kepuasan Sebagai Variabel Intervening ( Studi Kasus Pada Nasabah Koperasi Rejo Agung Sukses Cabang Ngaliyan )," *J. Manag.*, vol. 2, no. 2, 2016.
- [60] T. C. Mawey, A. L. Tumbel, and I. W. J. Ogi, "PENGARUH KEPERCAYAAN DAN KUALITAS LAYANAN TERHADAP KEPUASAN NASABAH PT BANK SULUTGO," *J. EMBA*, vol. 6, no. 3, pp. 1198–1207, 2018.
- [61] A. Ferdinand, *Structural Equation Modeling dalam Penelitian Manajemen . Edisi ke 2. Semarang: BP UNDIP*. Semarang: BP Universitas Diponegoro, 2015.
- [62] A. Parasuraman, V. Zeithaml, and L. Berry, "A conceptual model of service quality and its implications for future research," *J. Mark.*, vol. 49, no. Fall 1985, pp. 41–50, 1985.
- [63] I. Ghozali, *Aplikasi Analisis Multivariat dengan Program IBM SPSS 21 Update PLS Regresi*. Semarang: BP Universitas Diponegoro, 2013.
- [64] Sugiyono, *Metode Penelitian Administrasi*. Bandung: Alfabeta, 2010.
- [65] F. Tjiptono and G. Candra, *Pemasaran Strategik*. Yogyakarta: Andi, 2012.
- [66] F. I. Saputra, "Kualitas Layanan , Citra dan Pengaruhnya terhadap Loyalitas melalui Kepuasan Pelanggan ( Studi Pada PT Bank Bni 46 Sentra Kredit Kecil Surabaya )," *Apl. Manaj.*, vol. 11, no. 3, pp. 445–457, 2013, doi: 10.1016/j.eneco.2016.05.009.
- [67] E. Iriyanti, N. Qomariah, and A. Suharto, "PENGARUH HARGA, KUALITAS PRODUK DAN LOKASI TERHADAP LOYALITAS PELANGGAN MELALUI KEPUASAN SEBAGAI VARIABEL INTERVENING PADA DEPOT MIE PANGSIT JEMBER," *J. Manaj. Dan Bisnis Indones.*, vol. 2, no. 1, 2016.
- [68] S. Khoo, H. Ha, and S. L. T. McGregor, "Service quality and student/customer satisfaction in the private tertiary education sector in Singapore," *Int. J. Educ. Manag.*, vol. 31, no. 4, pp. 430–444, 2017, doi: 10.1108/IJEM-09-2015-0121.
- [69] E. W. Indarto, I. Suroso, S. Sudaryanto, and N. Qomariah, "the Effect of Brand Image and Product Attributes on Customer Satisfaction and Customer Loyalty," *J. Apl. Manaj.*, vol. 16, no. 3,

- pp. 457–466, 2018, doi: 10.21776/ub.jam.2018.016.03.10.
- [70] R. fang Chao, “The Impact of Experimental Marketing on Customer Loyalty for Fitness Clubs: Using Brand Image and Satisfaction as the Mediating Variables,” *J. Int. Manag. Stud.*, vol. 10, no. 2, pp. 52–60, 2015.
- [71] J. C. Mowen and M. Minor, *Perilaku Konsumen*. Jakarta: Erlangga, 2001.
- [72] S. Kundu and S. K. Datta, “Impact of trust on the relationship of e-service quality and customer satisfaction,” *EuroMed J. Business*, vol. 10, no. 1, pp. 21–46, 2015.

# **Revitalization of Islamic Religious Education Readiness Facing Era 5.0**

Nurzannah

## **Introduction**

Islamic religious education is a pillar of the nation's character and moral development. Therefore, Islamic Religious Education must be closely monitored so that its implementation is not backward and left behind because it is unable to keep up with the dynamics and changing times. The escort in question is not just seeing and paying attention, but making improvements in various aspects. This improvement is more directed at the form of revitalization of its existence substantially and comprehensively. It is very important to do this, considering that even within the country itself, Islamic education has not yet had a strong position. Even though it is de jure, that Islamic education has been equalized and has become part of national education and is the responsibility of the government. However, de facto, Islamic education still lags behind general education (others). It is no longer a secret that Islamic education has always been in a marginal position in the national education system [1]. So that the quality of Islamic education and learning cannot be accounted for, and seems almost a failure. Because the morals and character of the people of this nation are already alarming.

In addition, global changes have occurred massively. Meanwhile, the implementation of Islamic education seems stagnant, in the sense that the quality of Islamic education is not encouraging. For a long time, the quality of Islamic Religion teachers has been below that of general subject teachers. Not to mention related to facilities, funding, and others. Change is something sunatullah and is eternal. Even that change is considered the most eternal thing in this world [2] Therefore, change should not only be seen and watched. However, it must be followed, even challenged and conquered. This opening statement would like to usher in a discussion of the current changes and their relevance to the readiness to implement Islamic religious education in schools in Indonesia.

Islamic religious education is a pillar of the nation's character and moral development. Therefore, Islamic Religious Education must be closely monitored so that its implementation is not backward and left behind because it is unable to keep up with the dynamics and changing times. The escort in question is not just seeing and paying

attention, but making improvements in various aspects. The changing times and their dynamics can never be stopped, continue to move according to the cycle of time, and never reach a point. Likewise with the changes that are happening today. At the beginning of the 21st century, the world entered the era of 4.0, to be precise, starting in 2000-2005. At that time the internet began to develop, and continues to grow along with the development of science and technology. Era 4.0 is an industrial revolution that has the potential to increase global income and the quality of human life globally as well. Until now, the people who have benefited the most are consumers who can afford to buy and access the digital world; technology has enabled new products and services that increase the efficiency and enjoyment of human personal life. From ordering taxis, booking flights, buying products, making payments, listening to music, watching movies, or playing games, everything can be done remotely [3]. But keep in mind that in its application, the concept of industrial revolution 4.0 uses artificial intelligence [4]. This means that human functions can be replaced by smart technology.

The benefits presented by the technology of the 4.0 industrial revolution era were popularized with the term The Internet of Things (IoT). The main factor of IoT is the integration of various diverse technologies [5]. IoT aims to expand the benefits of continuously connected internet connectivity [6]. IoT integrates billions of smart devices that can communicate with each other with minimal human intervention [7]. Because the benefits are felt by most of the world's people, IoT has gained tremendous popularity in the last decade [8]. The benefits resulting from IoT cover almost all aspects of life, including education. The question arises "has the existence of IoT been used by teachers in learning, especially Islamic education teachers in schools"?

Before the Corona Virus 19 "endemic" in Indonesia, people's lives have shown symptoms of dependence on gadgets, as a result of the use of IoT. From adulthood to early childhood who have not been to school. The use of IoT has led to a new lifestyle in the wider community. There are various virtual world-based social communities, and so on. Most of their activities use internet-connected devices. Again, this is part of utilizing IoT. After the corona period - the last two years - human life is increasingly dependent on the internet. This is due to the occurrence of social distancing, limiting human activities outside the home. Everything that is needed can be done by using the internet. It is at this time that the world of education

has spectacularly switched to utilizing IoT. At a minimum, learn from home with an online system.

At the beginning of the transition of learning from an offline system to an online system, most of the educators in various educational institutions in Indonesia from the lowest to the highest levels experienced shock and pressure [9]. Did the Islamic Religious Education teachers not experience panic at that time? Of course you panic, right? How not? Lecturers and teachers, including Islamic religious education teachers - so far - have not touched digital-based learning. Although they are generally used to using gadgets as smart phones, they are only used as a means of communication, shopping, and watching entertainment. Therefore, the government's policy of shifting the learning system to online is a scourge for educators. Let alone digital-based learning, collaborative and challenging learning models and strategies are also very rarely used. This paper does not intend to demean Islamic religious education teachers. This is a bitter reality that must be revealed, so that it can be addressed in a better direction.

The condition of Islamic education teachers described above occurred in the industrial era 4.0. Not to mention that we and Islamic Religious Education teachers can take advantage of positively and maximally the opportunity for the development of learning technology in this 4.0 era, times have begun to shift to the industrial revolution 5.0 or enter a transition phase leaving the industrial revolution 4.0 [10]. Era 5.0 is a softer condition than the era of the industrial revolution 4.0. Because, the birth of the concept of society 5.0 originated from the anxiety experienced by the Japanese people since 1999 which has been severely affected as a result of the exploration of the 4.0 era which almost ignores human functions in the process.

## **Discussion**

Learning Islamic Religious Education in real terms, the quality is still below the quality of learning carried out by teachers of other subjects in schools. This is caused by many factors, including, 1) The education taken by previous Islamic religious education teachers was carried out in a very simple and conventional manner. The approach and method used when they learn, generally is a teacher-centered learning approach (Teacher Centered Learning). The popular method used is lecture; the highest is the question and answer method and group discussion [11]. This situation has been going on

for decades, and has been passed down from generation to generation; even today there are still many people who do this; 2) The ability of existing Islamic Religious Education Teachers, is not upgraded, so that it stagnates; 3) Developing technology and digital-based learning that is growing massively, is responded to in a relaxed manner (because the teacher's mastery of technology is still low) [12]; 4) The literacy culture of Islamic Education teachers is low [13], [14], especially the literary culture of students 5) inadequate facilities and infrastructure; 6) Funding is classified as low, and so on.

In addition to the above issues, it must be remembered that the generations that will be taught by Islamic religious education teachers today and in the next few years are Generation Z and Generation Alpha. Generation Z (Gen Z) is the generation born between 1996–2010 (although some argue that the generation born between 1995-2012. While the Alpha generation is the generation born from 2010-2025. These two generations have similarities and differences. When Gen Z was born, technology is developing. The first generation Alpha was born when the Apple Corporation launched the iPad product, Instagram was created, and App became the word in 2010. They are nicknamed screenagers, because the screen is in front of them at a very early age [15]. Will lead to different behavior and character between these two generations, especially regarding social behavior that tends to close itself to the outside world, because it is engrossed in its own work and the world of technology it has.

For Gen Z, teachers must immediately leave the old ways of teaching, in order to be successful in guiding them [16]. They not only have the virtual world, but also the real world [17]. Social media is the most intense communication medium used by Gen Z. They can spend hours on social media all day long. That is, Gen Z is very attached to Social Media. On the other hand, Generation Alpha has different characteristics and characters from Gen Z, including: Generation Alpha tends to be practical and behaves instantly, likes practical problem solving, Reluctant to spend a long process looking at a problem [18].

The description of the generation that will be taught by Islamic Education teachers, requires patterns and learning systems that suit their needs. Therefore, learning problems that must be addressed by Islamic Education teachers include those related to learning strategies and methods, mastery of technology, and low literacy culture of PAI teachers.



## Learning Strategies and Methods

Discussing the problem of strategies and learning methods used by PAI teachers in the learning process, we need to reflect for a moment on an atsar friend who is leaning on the following Ali bin Abi Talib.

لا تربوا اولادكم كما رباكم آباؤكم، فقد خلقوا لزمان غير زمانكم

"Do not educate your children as your fathers taught you, for they were not created in your time."

The signal that can be taken from the atsar of friends is that parents, educators, and teachers must teach their students with different strategies and methods from what their teachers used when they were students. The development of the times must be a mirror for teachers in determining learning approaches and methods. The learning approach that is required to fulfill 21st century skills in general is a scientific-contextual approach. While the learning method used is collaborative-variatif, which is based on Student Centered Learning (SCL). The scientific approach according to experts uses learning steps with the stages of observing, asking, reasoning, associating, and communicating [19]. Interestingly, this scientific approach (if applied correctly), is actually an approach that has a mind working cycle that almost cannot stop, unless the learner stops it himself, namely when it reaches the associative stage. This scientific approach is in accordance with the thinking needs of the 5.0 era, namely HOTS (Higher Order Thinking Skill).

This associative stage creates an associative way of thinking, where the results of the analysis carried out, stages and processes of associative thinking are the same as the implementation of the scientific approach process [20]. Associative thinking is carried out in accordance with the steps of a real scientific approach. At this stage students will arrive at the stage of communicating and acquiring new knowledge. Moreover, this scientific approach is combined with contextual learning, students learn and think with the real things around them, be it social events, natural events, and problems that they experience directly, especially those associated with Islamic values. This scientific-contextual approach is carried out using various collaborative learning methods. If this is implemented, young scientists who are sensitive to the environment and have an attitude of humanity and divine values will emerge.

The problem is, can the scientific-contextual approach and varied-collaborative learning methods be applied to Islamic religious education lessons? The answer is only one word, "can". Of course, religious teachers must really prepare lesson plans properly, such as analyzing the material to be taught before it starts, determining what problems are suitable to be given to students that are relevant to the subject matter to be taught, and the teacher himself must understand the various learning methods that can be used, and still have to provide solutions if needed by students. All these things can be done by the teacher, either with online or offline learning. If this is done by Islamic Religion teachers, then they have answered the friend's atsar stated above. Therefore, Islamic religious education teachers must also master multimedia technology.

### **Mastery of multimedia technology**

Mastery of multimedia technology is an absolute must for teachers, including Islamic Religious Education teachers. The massive use of IoT in everyday life requires Islamic religious education teachers to move from conventional learning to multimedia-based learning. Why is that? Because almost all of our students, especially junior high and high school levels, their daily life can hardly escape their smartphones. What more if the one being taught is the Alpha generation. Therefore, Islamic Education teachers must be good at reading this situation. Its use does not have to be every meeting (because, not every Islamic Education subject matter can be taught online), nor does it have to use complex and sophisticated applications. It's never too late; there's no such thing as a non-digital native generation. Anyone who wants to learn to take advantage of the IoT era, he can definitely master it according to his capacity (even though the teacher is a baby boom generation). Isn't it, one of the principles of using media and learning resources in learning is that they must also be in accordance with the abilities of the teacher [21], and of course they must also consider the conditions and needs of students.

The Covid-19 pandemic period (as explained above), is indeed difficult for teachers. This is because teachers are not used to doing multi-media-based learning processes, as well as students. Over time, there are many applications on the internet that can be used by teachers in carrying out the learning process, from simple to complex ones, such as; Google Classroom, Edmodo, Study House, Teacher Room, Your School, Smart Class, Zenius, Google Suite for Education,

Microsoft Office 365 for Education [22]. For teachers who are not used to it, learn by using simple applications, such as; WhatsApp Group, Zoom Meeting, Google Classroom, Google Meet, and others [23]. Although these applications are only used as a substitute for face-to-face classrooms, many research results mention their usefulness in the learning process carried out by teachers (it is not maximized, because there are still many inhibiting factors) [24].

In addition to the platforms or learning applications mentioned above, the internet also provides many learning resources that religious teachers can use to enrich their teaching materials, such as lectures by ustadz on YouTube, digital Al-Quran, digital Hadith, learning animations, scientific articles, and so on. All of that can also be used by students as a source of learning to do the tasks given by the teacher. The wealth of applications and learning resources on the internet is a shame if they are not used. Finding it is also not difficult, it even makes the teacher's task easier. The problem is, do Islamic religious education teachers understand and are proficient at using the internet and the learning applications in it? If so, it is hoped that this knowledge can be shared with more senior teachers. If not, then individually it is mandatory to study, and institutionally, the school must be willing to make efforts to improve the ability of religious teachers in their schools to have adequate abilities in utilizing technology in learning.

There are quite a number of channels on the Internet that provide tutorials on the use of multimedia in learning. This can be used as an educational tool for PAI teachers in order to improve their ability to use learning applications. Another way to improve the ability of teachers to use multimedia technology is to take part in various trainings which are of course facilitated by the school.

### **Literacy culture**

The meaning of literacy has now been expanded, but on this occasion it is defined as the ability to read and write. The literacy culture of Indonesian society is still very low. UNESCO noted that the reading interest index in Indonesia has only reached 0.001. This means that among 1000 Indonesians, only 1 has an interest in reading [25], [26]. This is an indicator that the average Indonesian people have low knowledge and critical thinking. Because, a high reading culture is one way to increase knowledge, and broaden one's thinking horizons. Meanwhile, the era of society 5.0 that has been echoed in dire need of human abilities in the HOTS (Higher Order Thinking Skill)

category, namely a complex, tiered, and systematic way of thinking. And this is what is called the high-level way of thinking of society in the era of society 5.0. One way to build a higher thinking process and understand a problem better is to read a lot.

Countries with a high level of public literacy are countries whose people have developed an interest in literacy for a long time. With that literacy culture, they are able to build and advance the civilization of their country. The problem of the low literacy culture in Indonesia, including the teachers is not a simple one. However, this is a serious problem that must be solved. According to the Governor of DKI Jakarta, Anis Baswedan, that in essence, the interest in reading by the Indonesian people is high, what is low is their reading ability [27]. This is illustrated that gadget users are able to read short WA chat messages for hours, but do not want to read long messages, especially books, this is reality.

## **Conclusion**

Society 5.0 is a good opportunity for Islamic Religious Education teachers to instill the values of rahmatan lil 'alamin to students, so that the frenzied development of technology and multi-media learning is not used by students and the community sporadically and worldly euphoria is meaningless. Era 5.0, as explained earlier, requires dynamic hands that are full of honing, compassion and care and wisdom, so that technological advances in era 5.0 still have a human side that is balanced with rapid and skyrocketing technological advances, and in using them one must be able to limit it.

Wanting to get to that point, teachers and all elements of the Islamic education process must maintain quality by continuously improving themselves in order to develop multi-media or digital-based learning. And directing students to be able and willing to upgrade high-level thinking skills with critical thinking, without forgetting to do Dhikr. Islamic religious education teachers must continue to hone and upgrade their knowledge, both related to the approach and learning methods they use, their ability to use multi-media technology, and improve their literacy culture. All that can only be done if there is a high awareness of each other. Because, no matter how often people support, and provide training to us, if we don't want to change, then the current condition will never change at all.

## References

- [1] M. Y. A. Bakar, "Problematika Pendidikan Islam di Indonesia," *DIRASAT Jurnal Manajemen & Pendidikan Islam*, vol. 1, no. 1, pp. 99–123, 2015.
- [2] R. Kasali, *Change*. Jakarta, 2005.
- [3] K. Schwab, "The Fourth Industrial Revolution: what it means, how to respond," 2016.
- [4] S. Yuliardi, "Warta Ekonomi.co.id Era Society 5.0, Apa Bedanya dengan Industry 4.0?," *WE. online*, 2020.
- [5] S. H. Shah, "A Survey : Internet of Things ( IOT ) Technologies , Applications and Challenges," vol. i, pp. 381–385, 2020.
- [6] Y. Efendi, "Internet Of Things (Iot) Sistem Pengendalian Lampu Menggunakan Raspberry Pi Berbasis Mobile," *J. Ilm. Ilmu Komput.*, vol. 4, no. 2, pp. 21–27, 2018, doi: 10.35329/jiik.v4i2.41.
- [7] M. A. Al-garadi, A. Mohamed, A. Al-ali, X. Du, and M. Guizani, "A Survey of Machine and Deep Learning Methods for Internet of Things ( IoT ) Security," pp. 1–42, 2020.
- [8] S. Sengupta and A. Sahay, "Social entrepreneurship research in Asia-Pacific: Perspectives and opportunities," *Soc. Enterp. J.*, 2017, doi: 10.1108/SEJ-11-2016-0050.
- [9] Nurzannah, "Serba Serbi Mengajar dengan Daring di Pandemi Covid 19," in *Catatan Pembelajaran Dosen di Masa Pandemi Covid-19*, 2021, pp. 42–47.
- [10] A. M. Ramli, "Pentingnya Bangsa Ini Mulai Adaptif Dengan Industri 5.0," *REPUBLIKA.CO.ID, BANDUNG*, 2021.
- [11] Nurzannah & Haidar Putra D., "Implementasi Kurikulum 2013 di MAN 1 Medan," *Anal. Islam.*, vol. 7, no., pp. 148–165, 2018.
- [12] H. Suherman, "Problematika dan Tantangan Pembelajaran Pendidikan Agama Islam di Tengah Pandemi Covid-19," *Tsamratul Fikri | J. Stud. Islam*, vol. 14, no. 2, p. 199, 2021, doi: 10.36667/tf.v14i2.533.
- [13] M. Nur, "Minat Baca Guru Pendidikan Agama Islam Terhadap Literatur Keagamaan Di Sma," *EDUKASI J. Penelit. Pendidik. Agama dan Keagamaan*, vol. 15, no. 3, pp. 327–348, 2017, doi: 10.32729/edukasi.v15i3.452.
- [14] C. Abidin, "Yang harus dilakukan untuk meningkatkan tingkat literasi Indonesia," *The Conversation*, 2017.
- [15] dkk. Anita Lie, *Mendidik Generasi Milenial Cerdas Berkarakter*. Yogyakarta: Kanisius, 2020.
- [16] A. Pujiono, "Media Sosial Sebagai Media Pembelajaran Bagi Generasi Z," *Didache J. Christ. Educ.*, vol. 2, no. 1, p. 1, 2021, doi:

- 10.46445/djce.v2i1.396.
- [17] N. F. Purnomo, A., Ratnawati, N., & Aristin, "Pengembangan Pembelajaran Blended Learning Pada Generasi Z," *J. Teor. Dan Praksis Pembelajaran IPS*, vol. 1, no. (1), pp. 70–76, 2016.
  - [18] E. Santosa, *Raising Children in Digital Era*. Jakarta: PT. Gramedia, 2015.
  - [19] M. Hosnan, *Pendekatan Sainifik dan Kontekstual dalam Pembelajaran abad 21: Kunci Sukses Implementasi Kurikulum 2013*. 2014.
  - [20] Nurzannah, "Paradigm of Associative Thinking Through A Scientific Approach In The 2013 Curriculum," vol. 2, pp. 864–868, 2021.
  - [21] S. Sungkono, "Pemiliban Dan Penggunaan Media Dalam Proses Pembelajaran," *Majalah Ilmiah Pembelajaran*, vol. 4, no. 1. 2008.
  - [22] M. H. Assidiqi and W. Sumarni, "Pemanfaatan Platform Digital di Masa Pandemi Covid-19," *Pros. Semin. Nas. Pascasarj.*, pp. 298–303, 2020.
  - [23] Nurzannah, "Learn Fun With Some Simple Digital," in *Digital Learning*, 2021, pp. 54–64.
  - [24] Reza, Nur Fitria., dkk. "Manfaat Media Internet dalam Pembelajaran PAI pada Masa Pandemi Covid-19 di SDN Linggarsari 1 Kecamatan Telagasari Kabupaten Karawang," 2021.
  - [25] A. Permatasari, "Membangun Kualitas Bangsa dengan Budaya Literasi," *Semin. Nas. Bulan Bhs. UNIB*, pp. 146–156, 2015.
  - [26] M. Suswandari, "Membangun Budaya Literasi Bagi Suplemen Pendidikan Di Indonesia," *J. Dikdas Bantara*, vol. 1, no. 1, 2018, doi: 10.32585/jdb.v1i1.105.
  - [27] J. Handipaningrat, "Video Anis Baswedan tentang Soft Skill," Jakarta, 2018.

# Gender Digital Divide and Empowering Women in the Industrial Age 5.0

Oktiva Anggraini

## Introduction

In the information age, many countries have replaced information sources from traditional organizations with high-level communications technology (*advance communication technology*). On the other hand, the technology that originally acted as tools for carrying out activities changing roles to gather information which develops continuously [1]. Another portrait of developing countries showing their unpreparedness for improvement technology overtakes technology in developed countries. It is this phenomenon that raises the digital divide or *digital divide* as a global problem. The digital divide has in turn resulted in gender inequalities in technology adoption. This article attempts to describe digital gender divide and empower women in the industrial era 5.0.

## Discussion

The digital divide has captured the attention of researchers and politicians in the era of 1990 in the United States by giving rise to the term *digital divide*. The issue of the digital divide, in turn, is global because the same problem is experienced by developing countries as well as poor countries. The concepts of the *digital divide* were born, including from the OECD (2001) which defines as the gap between individuals, households and actors business and geographical location of technology users in accessing technology communication and its use in a variety of activities. At a time when information technology revolves around the use of computers, the terminology of the digital divide is attached to the accessibility of the community to computer. This terminology then shifted when internet technology dominated and massive. Van Deursen and van Dijk (2010) call the digital divide more on the gap in the use of the internet in society [2].

The digital divide includes three stages [7]. The first one known as the *access divide* or gaps at an early stage which are marked with the number of people who access ICT (information technology and communication) and those without ICT. The next stage is the *usage divide*, the primary digital divide which is marked by differences in the use of ICT among citizens who have access to ICT. Finally, *the quality of use divide* which focuses on differences in the quality of

citizens' ICT use in everyday life.

Defines the digital divide as a term that distinguish between 'who has access' to ICT and those who 'do not'. Access to resources various digital forms, are interpreted [5] as things that a *multi-faceted* phenomenon that includes many interrelated factors such as: who which regulates access, skills and psychological and material factor use [4]. About actors who play a role in regulating access, placed on one's *financial* ability and vice versa who lack. Getting richer person, the greater the control over technology. Psychological aspects, more focus on an interest in ICT compared to those who lack interest or negative attitude towards technology. As for what is meant by access Skills include the ability of citizens to be characterized by high media literacy enough to be able to access *online* and the availability of time for access it. Medium access to materials, more associated with the availability of infrastructure owned structure [6].

The digital divide in turn extends to gender inequality in the adoption and use of the Internet by women compared to men. Technology is considered more masculine and less friendly to people women's interests. Gender inequality in the physical world is replicated indigital world.

Technology can overcome and be revered as a future changer, able to break down barriers that were originally constrained by geographical, class, racial and gender issues and socio economic levels. However, technological advances have not been able to end inequality and poverty immediately.

Technology is important in the pattern of social change. Technological phenomena cannot be fully understood without reference to gender issue. One of the most enduring technological inequalities is gender differentiation [3]. The social theory of technological construction (*social construction of technology*) said that technology is socially shaped by different social contexts. Society forms a potential medium that based on the possibilities of new technologies for creating messages and use, the most productive and in accordance with the community.

Technology is able to change so that the role of society is getting bigger in gender development by creating new possibilities about gender roles themselves apply in a new area. In view social formation, gender shapes development and the meaning of the technology itself. Technology is considered as the result of social formation (*social*)*shaping*). Social determination is closely related



to the theory of public space. Draft it provides a theoretical approach related to technology in particular with *new media* [8].

Proved that women lagging behind in technology ownership and the development of technological expertise [3]. Meanwhile, Van Voonen [10] explains the theoretical relationship feminism with information technology. Publications identify the lack of women's involvement in the creation of the latest technological designs. However, their role as consumers of certain technologies, women's participation in The virtual world is supported by many factors including *cyberfeminism*. *Cyberfeminism* is a rebellion against the world's patriarchal culture which demands a change between women and computers and the chain of relationships and communication [10]. Unlike Spender women need to catch up with men to get the power and financial benefits of technology. *Cyberfeminism* asserts on the predominant role of gender in social relations and as a result of women's oppression [10].

The following reports will demand a global picture of *the gender digital divide* and the barriers to accessing and using the internet. *The International Union Technology* (2019) notes that more than 393 million women in developing countries do not own a mobile phone. The internet penetration rate for women is 41% while that for men is 59% [16]. In terms of cellular ownership, there is a larger gender gap in South Asia at 23 percent while in sub-Saharan Africa it is 13 percent [15]. In everyday life, women are more likely to share cell phones with other family members than men. Women are 20% less likely to own a *smartphone* than men.

The *World Wide Web Foundation* (2020) analysis found that the gender gap in the internet in developing countries increased by 55% worldwide from 2013-2019 [9]. The gap in internet access is just one element of a much larger digital gender divide. This gap includes all the ways in which women are less able to use and influence the technologies that are reshaping the world. In terms of meaningful connectivity, the *Alliance for Affordable Internet* (A4AI) also measures these countries against a minimum threshold, adequate devices and sufficient amount of data. The number of online tasks, economic transactions and others demand greater internet bandwidth. Again, the performance of developing countries is far behind.

In terms of features, women more often have simple feature phones and are less supportive of internet use [15]. These two facts show that women's purchasing decisions and purchasing power of cellphones are lower than men's. The simplicity of feature phones

means that women's abilities are limited in buying cell phones. Not to mention in terms of *usability*, the phone which is too simple is realized that it does not support its accessibility to the internet. Some jobs that require the possession of a smartphone will result in women's dependence on other parties. Continuous dependence will result in a lack of women's *performance* in the workplace work. The *digital divide* in Indonesia needs to be underlined specifically so that get attention because it is still far from expectations. In the 2019 IMD *World Digital Competitiveness* survey, Indonesia is ranked in the eight lowest countries (56) in the world. Compared to countries in Southeast Asia, Malaysia's position is at number 26 and Singapore is in position 2. This was acknowledged by President Jokowi on one occasion. His statement is in line with the *Report from the Global Competitive Index*. Indonesia won 64,629 points in 2019. lower than the previous year of 64,935 [11].

To address the technology gap, it is necessary to identify some of the main causes. First, financial ability. The portrait of poverty in the country can be an absolute explanation. Not all information technology devices such as laptops, gadgets and *wifi* services can be reached by the public. Report A4AI (2018) shows that internet users in rural areas refrain from buying internet quotas because of the high price of quotas. Second, the technology infrastructure is uneven. With a population of more than 260 million people, internet users in the country exceeded 171 million people in 2018, However, with the wide coverage area of the country which is dominated by other waters and 60% of farmers and fishermen, many villages have not been reached by facilities. electricity and internet [12].

The lack of skills and knowledge in technology is the next cause. The unequal education of the community affects their accessibility in the use of technology. Elementary school children in urban areas are more familiar with smartphones so they can easily adapt to various online lessons. This condition is different from students in rural areas who are not used to even having a smartphone. Lack of digital skills also ranks highly as a barrier to accessing the internet. A4AI stated that the main reason besides financial is mastery of media literacy. As many as 45% of non-internet users cited this as the main reason they did not use the internet.

The fifth consideration is that women feel insecure and comfortable surfing in cyberspace. Women are more worried about their personal data (private messages, home address and health information) being exposed in public than men. The last consideration

that needs to be considered is the life style and culture and philosophy that developed in the country. The condition of rural communities who make up a large part of our country is accustomed to living in harmony, mutual cooperation and mutual assistance. This is manifested in his social life which prefers face-to-face activities such as social gathering, family gatherings to *village meetings*. They are not used to virtual invitations, virtual meetings (with *zoom, google meet, tuweb etc.*) and may find the new practice strange, disrespectful and ethical. Social capital as a reinforcement of community ties cannot be simply removed with a set of technologies. It takes a long time for changes to get used to the community with the new order that is all based on information technology [13].

The COVID-19 pandemic has changed the world system and underlined how important access to global information technology is. This phenomenon revealed the phenomenon of striking inequality around the level of welfare, geography, gender and age that makes some citizens vulnerable to the virus and its effects. The lack of media literacy results in the performance of almost all elements of development. As a simple example, farmers who are not digitally literate will have difficulty digesting all-digital information and distributing agricultural assistance, counseling through *online media*. They find it difficult at harvest time when it comes to marketing *online*. As a result, not a few farmers let their crops rot on the land or were thrown away during this pandemic. It's just one example that disproportionate digital growth will become a serious problem.

For the millions of women with limited internet access, this savior had a detrimental effect. Remembering girls play a disproportionate role as front line employees, caregivers, educators, gendergap impacts on families and communities economy. In fact, when there is an effort to increase gender equality the whole society will benefit. Digital development inclusiveness will be very important while all countries want to emerge from the crisis Covid 19, Indonesia is no exception [14].

In early 2020, the government is strengthening the industrial economy digital by encouraging the growth of *start-ups*. One of the programs that The result is the Movement of a Thousand Startups or *start-ups* which in. In turn, it is expected to reduce economic inequality and the Gini Ratio figure. In local level, the Gandeng Gendong program carried out in the city of Yogyakarta for example, has been able to empower women and marginalized communities. Anggraini's research (2021) shows that through the Gandeng Carry

program, (GAGE), social capital can be a bridge in gaining access to resources, both capital, facilities and economic instruments such as education and training for the development of the creative economy in Yogyakarta. When knowledge becomes an important part of innovation that society needs then the knowledge-producing college and duty transform it, play a role in raising the creative economy. Through Gage, inspired by the spirit of *Segoro Amarto*, this program collaborates with actors/businesses, especially women, to take part in digital literacy training. Activity similar growth and bloom in various big cities driven by various NGOs, religious leaders, community leaders as a form of overcoming the complexity economy during a pandemic. This shows that the pandemic period provide inspiration to explore the use of technology digitally more inclusively and pay attention to *resilience* aspects [15].

Currently, Indonesia has entered a transition phase leaving the Revolution Industry 5.0. The industrial revolution 4.0 places more emphasis on the digital revolution in the form of cyber physical. Whereas in the industrial revolution 5.0 the emphasis was on the role of humans as the center of civilization that utilizes digital technology as a tools of life in various fields. Industry 5.0 is not only focused on machine-to-machine relations and robotic effectiveness, but on human-to-human/machine. The role of the machine can drive public infrastructure and others.

Indonesia has no other choice but to continue development digital infrastructure, create policies and regulations that encourage efficient and progressive growth of the telecommunications industry. Given, digital technology will not automatically empower the marginalized and destroy traditional power structures without investment and commitment government to address this gap. Furthermore, efforts to empower women or increase the role of adolescent girls in access to and use of communication technology and information should take into account the number of *barriers* they have woman. Mainly in terms of more supportive social norms men's interests and their control over internet devices.

With seriousness in realizing digital gender equality, it will ensure that women and girls can participate fully online without fear for their safety or rights. More future sunny will not wait. The involvement of parents and digital literacy for them is expected to lead to a better understanding of the value of girls' digital adoption. Especially since the Corona outbreak that hit in 2020. Like it or not technology is the only solution so that humans can continue to

interact and carry out various activities, even though there are social restrictions in order to reduce potential spread of the virus. The government should commit to collecting gender data in technology sector regularly and publish it publicly. In formulating policies related to women, *policy makers* need disaggregated data by gender taking into account the specific experiences of men and woman [16].

This is a serious problem, not only for Indonesia because the data UNDP (2018) shows that less than half of the world's countries report the percentage of data on male and female internet users and only a fewable to report it regularly. To expand the connectivity target meaningful internet, the government needs to increase the network bandwidth internet so that people who access the internet do not experience difficulties which means. Meaningful connectivity targets provide a complete picture of Internet access that is perceived by the community as well as helping *policy makers* to formulate a more appropriate *policy* in minimizing the digital divide between gender and connect more people to the internet and empower Public.

Above all expansion of tools and infrastructure, literacy issues media is very important. The government must invest and improve media literacy for women. Transformative gender policies and culture provide tools that empower women by providing they have the opportunity and control over ICT, determine what type of ICT is and what they need and wrap it up with supportive policies women to achieve their goals. With this social dimension needed to be integrated in decision-making that impacts the role women in ICT [14].

With digital skills and better media literacy, it is hoped that it will be able to encourage the role of women to create content which is beneficial for both women and society at large. Thus, women not only use technology but play a role determine the flow of information technology that is right for him and the community. Today, less than a third of professionals in the technology sector are women. This means that men still dominate content in this sector (UNDP, 2018). Governments should develop national strategies to support education, innovation and technology leadership for women and girls so that their perspective is reflected in technology design and development.

## **Conclusion**

In closing, it can be concluded that the emergence of the *digital gender divide* is related to financial problems, infrastructure

readiness and the lack of women's and socio-cultural skills. Media literacy and the government's commitment to technology investment cannot be delayed any longer to overcome the *digital gender divide*. Therefore, the realization of gender equality in mastering digital technology does not only lead to the fulfillment of rights for women, but will support the progress and prosperity of the nation.

Transformative gender policies and culture are realized by providing tools that empower women, provide opportunities and control and use ICT. The state is not present enough alone, it needs close cooperation between the private sector and universities to facilitate it. Many government programs and private collaborations are systemically focused on gender equality and still demand an active contribution from the world of higher education. As university people, researchers who are active in the field of research and community service are expected to be able to support the above needs to realize digital gender equality.

## Reference

- [1] Aghaei, Sareh, Mohammad Ali Nematbakhsh dan Hadi Khosravi Farsani. 2012. Evolution of the World Wide Web: from Web 1.0 to Web 4.0. *International Journal of Web & Semantic Technology (IJWesT)* Vol. 3, No. 1, January 2012.
- [2] Choudhury, Nupur. 2014. World Wide Web and Its Journey from Web 1.0 to Web 4.0. *International Journal of Computer Science and Information Technologies*, Vol. 5 (6), 2014, 8096-8100.
- [3] Dixon, L. J., Correa, T., Straubhaar, J., Covarrubias, L., Graber, D., Spence, J., & Rojas, V. (2014). Gendered space: The digital divide between male and female users in internet public access sites. *Journal of Computer-Mediated Communication*, 19, 991–1009. DOI: 10.1111/jcc4.12088
- [4] Gurung, Lina, The Digital Divide, *Dhaulagiri Journal of Sociology and Anthropology*, volume 12, 2018, pp 50-57.
- [5] Harris, Thomas E. dan Mark D. Nelson. 2008. *Applied Organizational Communication: Theory and Practice in A Global Environment*. New York: Taylor & Francis Group
- [6] Hartley, Peter dan Clive G. Bruckmann. 2002. *Business Communication*. London: Routledge.
- [7] Molnar, S.2003. *The explanation frame of the digital divide. Proceedings of the IFIP summer school 'Risks and challenges of the networked society*. Karlstad University, August.
- [8] Norris, P., 2001, *Digital Divide: Civic Engagement, Information*

- Poverty, and The Internet Worldwide (Communication, Society and Politics)*; Cambridge University Press: Cambridge, MA, USA.
- [9] Octavianto, A. W. 2014. Strukturasi Giddens dan social construction of technology (SCOT) sebagai pisau analisis alternatif penelitian sosial atas teknologi media baru abstrak teknologi dan masyarakat. *VI(2)*, 41–57.<http://library.umn.ac.id/jurnal/public/uploads/papers/pdf/7a99d56d426087ec0e1e8dd3fb026f6b.pdf>
- [10] Royal, C. 2008. Framing the internet: A comparison of gendered spaces. *Social Science Computer Review*, 26(2), 152–169. DOI: 10.1177/0894439307307366.
- [11] Supriyanta, Oktiva Anggraini, 2021, Rekapitalisasi Modal Sosial dan Pengembangan Ekonomi Kreatif Berbasis Triple Helix di Yogyakarta Era New Normal, Prociding SEMINAR NASIONAL & CALL FOR PAPER, Universitas Kristen Immanuel Yogyakarta.  
<http://journal.ukrim.ac.id/index.php/PFE/article/view/28>
- [12] Van Dijk, J.; Hacker, K. The Digital Divide as a Complex and Dynamic Phenomenon. *Inf. Soc. Int. J.* 2003, 19, 315–326.
- [13] Van Zoonen, L. 2002. Gendering the internet: Claims, controversies and cultures. *European Journal of Communication*, 1(1), 5–23
- [14] Wahyuningtyas, Neni dkk. *Digital Divide Perempuan Indonesia*, Jurnal Sejarah dan Budaya, 2016, tahun ke sepuluh no.1.pp 87-88.
- [15] GSMA Connected Women, 2020. The mobile gender gap report 2020.  
<https://www.gsma.com/mobilefordevelopment/wpcontent/uploads/2020/02/GSMA-The-Mobile-Gender-Gap-Report-2020.pdf>
- [16] ITU, 2019. Facts and figures. <https://itu.foleon.com/itu/measuring-digitaldevelopment/home> World Wide Web Foundation, 2020, Hak-Hak Daring Perempuan: Menutup kesenjangan digital gender demi dunia yang lebih setara. UNDP Annually REPORT, 2018.

# **Practicing Communication, Collaboration, Critical Thinking and Creative Thinking Skills in Learning**

Peni Suharti<sup>93</sup>

## **Introduction**

21st century skills, which consist of communication, collaboration, critical thinking and creative thinking skills are today's global demands [16], [5]. Thus, these 21st Century Skills must be developed in students [13], [9], [3], [19]. Collaboration and communication skills are tools of life in carrying out their activities both in the community, education, and work environment, while critical and creative thinking skills are needed in solving problems faced in real life. For this reason, the learning process must facilitate the development of the four 21st century skills in students [5], [19]

Communication skills are important soft skills that must be achieved by students in the learning process [9]. Soft skills are closely related to the ability of students to communicate the results of their observations or decisions taken. The results of students' thoughts should be able to be clearly communicated by students, both in writing and orally. By communicating what they think in the learning process, they will better internalize what they understand

Collaboration skills are another skill that students need to have [7], [13]. When students collaborate, it will involve the active participation of students to achieve common goals with a high positive dependence in solving academic and daily life problems. Through collaboration, students who have low abilities will also be helped to achieve the expected learning goals. [2], [6], [12]. For this reason, it is very important to facilitate students to have collaboration skills.

Based on the results of research at Harvard University, the National Association of College and Employee (NACE) states that the most important indicators of a champion are the ability to collaborate/collaborate, integrity, communication, and ethics. 80% of a person's success is determined by the person's soft skills in managing themselves and others. While hard skills such as skills and technical knowledge only determine 20%. [9].

Creative thinking skills are divergent thinking activities which are the foundation for producing something new (original), then reflected in changes in one's mental or personality. Creative

---

<sup>93</sup> Universitas Muhammadiyah Surabaya



thinking will direct the development of knowledge already possessed by students, provide other perspectives and reconstruct it into a product as a form of creative thinking. Therefore it is important to develop creative thinking skills in students. [8]

[19] stated that creative thinking skills are very important to be realized by teachers in the science learning process because there is a discovery process that can hone students' creative thinking. If creative thinking skills are not developed, it will lead to low understanding of concepts by students. Learning activities that will encourage students to think creatively in science learning are investigative activities that allow students to conduct investigations. This learning activity will encourage students to think creatively.

Critical thinking skills are reasonable and reflective thinking that focuses on deciding what to believe or do. Critical thinking is a systematic process used in mental activities such as problem solving, decision making, analyzing assumptions, and conducting scientific research. Critical thinking is an activity to evaluate or evaluate something in an effort to make rational and reasoned judgments and conclusions. This means that critical thinking allows students to evaluate evidence in an effort to make rational conclusions. Based on the expert opinion above, it can be stated that critical thinking skills are needed in solving problems faced in real life, so that critical thinking skills need to be mastered by students. For this reason, students must be facilitated to have critical thinking skills [4], [19].

This is in line with Permendikbud No. 20 of 2016 about concerning graduate competency standards, which explains that the competency standards of education unit graduates in the field of skills have acting and thinking skills which include: independent, collaborative, communicative, productive, critical, and creative, through a scientific approach as a development of what is learned in the unit. education and other resources independently.

Efforts that can be made to improve students' communication, collaboration, critical thinking and creative thinking skills are by conducting learning using learning strategies that apply investigative steps. Through investigation, it will encourage students to become thinkers and be able to provide many alternative answers to a problem. And work together to solve problems faced through student communication and collaboration. The learning environment that is formed must provide opportunities for students to think openly and flexibly without fear and shame. In addition, the learning environment must have a situation that facilitates discussion and

encourages students to convey ideas so that communication and collaboration occurs among students [1].

The problem that arises is what learning model can facilitate students in practicing communication skills, collaboration, critical thinking and creative thinking? The purpose of this study is to describe the appropriate learning model to facilitate students in practicing communication and collaboration skills, critical thinking and creative thinking, based on literature studies..

## Discussion

Learning models that are able to train communication and collaboration skills, critical thinking and creative thinking are learning models that are able to create positive dependence among students, as well as facilitate students' critical and creative thinking processes. These four skills can be facilitated through investigative steps to solve problems [14], [15]. The investigation in question is an investigation that will encourage students to become good thinkers and be able to provide many alternative answers to a problem through communication and collaboration. To collaborate there must be positive dependence among students.

The IBSC (Investigation Scientific Based Collaborative) learning model is a collaborative learning model that has 5 syntaxes, namely: 1) Motivation and Problem Orientation, 2) Sharing Task Collaboration Investigation, 3) Presentation, 4) Jumping Task Collaboration Investigation and 5) Evaluation (Suharti , P., 2019). The explanation of each syntax is as presented in table 1

**Table 1: Teacher and Student Activities in the IBSC Learning Model**

<b>Theacher Activities</b>	<b>Student Activities</b>
Phase 1: Motivation and problem orientation	
1. The teacher motivates to arouse students' interest by presenting/raising facts, phenomena, or issues related to the learning objectives that must be achieved	1. Students are motivated and interested when presented facts, phenomena, or problem issues related to the learning objectives that must be achieved
2. The teacher conveys the objectives of learning,	2. Students pay attention to the objectives of the learning delivered by the teacher.
3. The teacher provides direction regarding the collaborative	

<b>Theacher Activities</b>	<b>Student Activities</b>
learning process as well as the assessment of communication skills and collaboration skills in the learning that is carried out	3. Students listen to the teacher's directions about the collaborative learning process and the assessment of communication skills and collaboration skills in the learning that is carried out.

Phase 2: Collaboration Investigation  
Sharing task

- |   |   |
|---|---|
| <ol style="list-style-type: none"> <li>1. The teacher gives students a Student Worksheet (LKS) containing assignments that are sharing tasks for each group</li> <li>2. The teacher explains the instructions for carrying out the discussion and their duties along with the sources that will be used</li> <li>3. The teacher acts as a mediator and facilitator to increase students' positive dependence so that communication and collaboration occurs among students by fostering empathy for high-skilled students and raising the courage of students who do not understand to ask their friends who already understand. Through 4 steps:               <ol style="list-style-type: none"> <li>a. The teacher goes around observing the work in each group to find out which students have difficulty or do not understand and which students already understand.</li> <li>b. The teacher asks students who do not understand which part has not been understood.</li> <li>c. The teacher tells the group if any of their friends do not understand.</li> <li>d. The teacher subtly asks students who do not understand to ask their friends who already understand and subtly asks students who already understand to help their friends who do not understand.</li> </ol> </li> </ol> | <ol style="list-style-type: none"> <li>1. Students receive student worksheets (LKS) containing tasks that are sharing tasks in each group</li> <li>2. Students listen to the teacher's explanation of the instructions for carrying out the discussion and their duties along with the sources that will be used</li> <li>3. There is a different role for each student in the group to take part in solving the main problem of sharing tasks</li> <li>4. Students who do not understand dare to ask their friends who already understand.</li> <li>5. Students who already understand help their friends who do not understand</li> <li>6. There is a positive dependence among students so that communication and collaboration occurs among students because of the growing sense of empathy in high-ability students and the courage of students who do not understand to ask their friends who already understand.</li> </ol> |
|---|---|

Phase 3: Presenting/Presentation

<b>Theacher Activities</b>	<b>Student Activities</b>
1. The teacher asks students to present/present by displaying the results of the discussion (LKS Sharing task)	1. Students present information logically on the results of their group work
2. The teacher guides the students to have a discussion.	2. Students manage time proportionally during presentations
3. The teacher acts as a mediator and facilitator for communication and collaboration in class discussions	3. Students use image media
	4. Students speak without grammatical errors with good gestures
	5. Students use the appropriate volume of voice and speech when delivering
	6. Students understand the listener's question
	7. Students integrate knowledge when answering questions

#### Phase 4: Collaboration Investigation jumping task

- |  |  |
|--|--|
| <ol style="list-style-type: none"> <li>1. The teacher gives a follow-up task in the form of a problem from jumping material (Jumping task) both conceptual and application that exceeds the minimum competence that must be completed collaboratively.</li> <li>2. The teacher acts as a mediator and facilitator to facilitate the occurrence of positive student dependence so that communication and collaboration occurs among students by fostering empathy for high-ability students and raising the courage of students who do not understand to ask their friends who already understand, by:               <ol style="list-style-type: none"> <li>a. The teacher goes around observing the work in each group to find out which students have difficulty / do not understand and which students do.</li> <li>b. The teacher asks students who do not understand which part has</li> </ol> </li> </ol> | <ol style="list-style-type: none"> <li>1. Students work on advanced tasks in the form of problems from Jumping tasks, both conceptual in nature or application that exceeds the minimum competence that must be completed collaboratively through LKS.</li> <li>2. High ability students feel challenged to complete the jumping task</li> <li>3. There is a different role for each student in the group to solve the problem.</li> <li>4. Students who do not understand dare to ask their friends who already understand.</li> <li>5. Students who already understand help their friends who do not understand</li> <li>6. There is a positive dependence among students so that communication and</li> </ol> |
|--|--|

<b>Theacher Activities</b>	<b>Student Activities</b>
<p>not been understood.</p> <p>c. The teacher tells the group if any of their friends do not understand.</p> <p>d. The teacher subtly tells students who do not understand to ask their friends who already understand and subtly asks students who already understand to help those who do not understand.</p> <p>Phase 5: Evaluation</p> <ol style="list-style-type: none"> <li>1. The teacher guides students to review the material that has been studied today.</li> <li>2. The teacher motivates students whose jumping tasks have not been completed to finish at home by collaborating in their groups</li> <li>3. The teacher informs the students that the post test is carried out after learning 1 KD is complete (3 meetings)</li> <li>4. The teacher ends the lesson by greeting</li> </ol>	<p>collaboration occurs among students because of the growing sense of empathy in high-ability students and the courage of students who do not understand to ask their friends who already understand.</p> <ol style="list-style-type: none"> <li>1. Students review the material that has been studied today under the guidance of the teacher</li> <li>2. Students whose jumping tasks have not been completed can finish at home by collaborating in their groups</li> <li>3. Students listen to the explanation about the implementation of the post test</li> <li>4. Students answer the teacher's greeting when the lesson ends.</li> </ol>

**(Sourch, Suharti, 2019)**

Based on the activities of teachers and students in the syntax of the Investigation Based Scientific Collaborative (IBSC) learning model, it can be said that the IBSC model can facilitate students in practicing the four 21st century skills. This can be explained as follows. In the IBSC model there is the Investigation Collaboration Sharing Task syntax (second syntax) and Investigation Collaboration Jumping Task (fourth syntax). In both syntaxes, students are asked to carry out investigations to solve the main problem through solving the sub-problems given. This main problem can only be solved if the sub-problems have been resolved first. Sub-problems are distributed to members to be resolved and become their expertise in the problem. So to be able to solve the main problems students must communicate and collaborate in groups.

When group members are completing their tasks on the Syntax Investigation Collaborative Sharing task and Jumping Task, the teacher acts as a mediator and facilitator to foster positive dependence among students. The way the teacher does is observe in each group whether there are students who have difficulty in solving the problems that are their assignments. If one member of the group (expert) has difficulty, the teacher tells the student to ask a friend in the group for help who can help. The teacher also reminds students who have high abilities in the group to be willing to help friends in groups who are having difficulties. The teacher reminds that if one sub-problem is not resolved then the group will not be able to solve the main problem. That way, a positive dependence among students in the group will occur. When positive dependence has occurred among students in the group, this will encourage communication and collaboration among students. After each expert solves the sub-problem, then they communicate with each other and collaborate to solve the main problem. Without communication and collaboration among group members, major problems will not occur. Thus the IBSC model can facilitate communication and collaboration skills. This is in accordance with the opinion of Moreno (2010). about positive dependency theory and positive transfer. Likewise with the opinions of [14], [15], which state about positive dependency theory, Sharing Task Investigations and Jumping Task Investigations.

When each member of the group who acts as an expert is able to solve the sub-problem or when the group solves the main problem, critical and creative thinking skills are needed. Because when they try to solve the problem, there will be analysis, synthesis and evaluation as well as creating their thinking process to ensure the answer is correct and appropriate in solving the problem. Students will think openly, divergently and critically.

## **Conclusion**

To practice communication skills, collaboration, critical thinking and creative thinking, in learning, you can use the IBSC Learning model through the syntax of Sharing Task Collaboration Investigation and Jumping Task Collaboration Investigation. Both of these syntaxes facilitate students to think analytically openly and divergently and facilitate positive dependence between students.

## References

- [1] Asmara, R., Susantini, E., & Rahayu, Y. S. (2015). Pengembangan Perangkat Pembelajaran Biologi Berorientasi Pendekatan TASC (Thinking Actively in Social Contexts) Untuk Melatihkan Keterampilan Berpikir Kreatif Siswa. *Pendidikan Sains Pascasarjana Universitas Negeri Surabaya*, 5(1), 885-890
- [2] Burns, M., Pierson, E., & Reddy, S. (2014). Working together: How teachers teach and students learn in collaborative learning environments. *International Journal of Instruction*, 7 (1), 17-32
- [3] Care, E. & Griffin, P., Scoular, C., Awwal, N., Zoanetti, N. (2015). Collaborative problem solving tasks. In P. Griffin & E. Care (Eds.), *Assessment and teaching of 21st century skills: Methods and approach*. Dordrecht: Springer
- [4] Ennis R H. (1996). *The Nature of Critical Thinking: An Outline of Critical Thinking Dispositions and Abilities* University of Illinois
- [5] Hakkinen, P., Jarvella, S., Markitalo, S.K., Ahonen, A., Naykki & Valtonen, T. (2016). Preparing Teacher-Student for Twenty-first-century Learning practices (PREP 21): A Frame work for Enhancing Collaborative Problem Solving and Strategic Learning Skills. *Teachers and Teaching Theory and Practice*, pp 1-17.
- [6] Jones, H. M. B. & Vall, O. C. (2014). Preparing special educators for collaboration in the classroom: Pre service teachers' beliefs and perspectives. *International Journal of Special Education*, 29 (1), 1-12.
- [7] Kemendikbud. (2016). *Salinan lampiran peraturan menteri pendidikan dan kebudayaan nomor 20 tahun 2016 tentang standar kompetensi lulusan pendidikan dasar dan menengah*. Jakarta: Kemdikbud
- [8] Listiana, L., & Bahri, A. (2019). Empowering Student's Creative Thinking Skill In Biology Classroom: Potential Of Group Investigation Combined With Think Talk Write (GITTW) Strategy. *Humanities & Social Sciences Reviews*, 7(3), 477-483.
- [9] NRC. (2011). *Assessing 21st Century Skills: Summary of a Workshop*. J.A. Koenig, Rapporteur. Committee on the Assessment of 21st Century Skills. Board on Testing and Assessment, Division of Behavioral and Social Sciences and Education. Washington, DC: The National Academies Press
- [10] National Research Council. (2015). *Enhancing the effectiveness of team science*. Committee on the Science of Team Science, N.J. Cooke and M.L. Hilton, Editors. Board on Behavioral, Cognitive, & Sensory Sciences, Division of Behavioral and Social Sciences and

- Education. Washington, DC: The National Academies Press
- [11] Nielsen, K.H. (2012). *Scientific Communication and the Nature of Science*. Science & Education.
  - [12] OECD. (2015). *OECD programme for international student assessment 2015*. OECD Publishing
  - [13] Partnership 21<sup>st</sup> century Skill. (2010). 21<sup>st</sup> Century Knowledge and Skill in Educator Preparation, AACTE
  - [14] Sato, Manabu. (2014). *Mereformasi Sekolah: Kosep dan Praktek Komunitas Belajar*. Edisi Indonesia. Tokyo: The International Development Centre of Japan Inc.
  - [15] Sato, Masaki. (2011). *Dialog dan Kolaborasi di Sekolah Menengah pertama, Praktek learning Community*, Kerjasama Depdiknas, Depag dan Jica.
  - [16] Scott, C.L. (2015). The Future of Learning 2: What Kind of Learning forTehe 21<sup>st</sup> Century? Education Research Foresight. Working Paper, pp 1-14
  - [17] Slavin. (2008). *Collaboratif learning: teori, riset dan praktik*. Bandung. Nusa Media
  - [18] Suharti, P. (2020). Validity of Investigation Based Scientific Collaborative (IBSC) Learning Model To Facilitate Students' Communication and Collaboration Skills. International Conference on Research and Academic Community Services (ICRACOS 2019). Vol.390
  - [19] Zubaidah, S. (2016). Keterampilan Abad Ke-21: Keterampilan Yang Diajarkan Melalui Pembelajaran. *Isu-isu Strategis Pembelajaran MIPA Abad 21* (pp. 1-17). Sintang: STKIP Persada Khatulistiwa Sintang



# Utilization Of *Canva* in Learning to Write Poetry as a Learning Source in the Era Society 5.0

Purwati Zisca Diana

## Introduction

The Covid-19 pandemic has exposed many weaknesses in the implementation of national education, ranging from infrastructure readiness to human resources, particularly the capacity and creativity of educators. It is not surprising that education has been one of the hardest-hit sectors. Teaching and learning activities were almost paralyzed. Some are not familiar with the concepts, characteristics, communication approaches, and strategies of distance education. As a result, learning activities only take place in one direction. Almost every day students are burdened with various teaching materials and assignments. Therefore, educators must be able to recognize and master various applications to support interesting and participatory teaching and learning activities. In addition, educators must also prepare teaching materials according to the needs of students.

During the pandemic, many schools shifted conventional teaching and learning activities that were held face-to-face in classrooms to distance education with virtual classes through applications such as *zoom meetings*, *google meet*, or similar applications. Online learning (online) is a distance education that is carried out using internet-based communication media [1]. Without the support of a relatively stable internet connection, online learning cannot run effectively. The problem is, in some areas the availability of the internet network is still limited, causing problems during the virtual learning process [2].

Along with the development of technology, the current learning process is forced into the world of digital education. One form of technological development is *society 5.0* which was initiated by Japan. *Society 5.0* is a modern-based science that utilizes the technology *internet of things*. Therefore, digital education is an evolution of distance education which was originally done by post [3]. Students today are called generation Z or generation Alpha who was born in a digital environment so they are called digital *natives*[4]. This generation is considered to have digital instincts so that they quickly adapt to the digital world.

New technologies in education have a number of characteristics that are the strengths of digital education [5]. These

characteristics develop according to the progress of new media that allow simultaneous interaction, are connected to massive data and are multimedia [6]. However, the adoption of new digital technologies in education does not in itself bring about changes in educational praxis.

The touch of technology in the learning process makes educators and students have to adapt to various media, models, methods, and digital-based approaches. Included in the creative learning of literature. Appreciating literary works is not easy because it requires experience in processing ideas and creativity into literary works [7]. The learning process in the classroom will be easier and maximum if the educators also have the knowledge and experience of creative writing. One of the creative writings of literature is poetry. Poetry has the characteristic of condensing language. Naming the poem according to its density or concentration, in Dutch the poem is called *gedicht* or in German *Dichtung*; the term contains the meaning of "compacting or concentration", *dichten* means "composing poetry", and also means "compacting"[8].

The use of technology for educators and students plays a very important role in the process of teaching and learning success. However, online learning which has been running for almost two years has had a saturation effect, both for educators and students. The ability of educators to develop learning programs and produce teaching materials is a demand in digital education. Therefore, this paper aims to describe the utilization of the instructional media *Canva* on learning to write poetry to overcome the saturation students in online learning (*online*) during a pandemic and prepare Covid-19 digital education in learning in the age of *society 5.0*.

## **Discussion**

### **of Teaching Materials Teaching**

Materials are all forms of materials used by educators in the implementation of teaching and learning activities in the form of written materials (books, modules, *handouts*, student worksheets, brochures, etc.) and unwritten materials (video/film, interaction-based internet, *podcasts*, CDs, cassettes, and so on) [9]. The material in teaching materials is a means of learning for students to achieve learning objectives in accordance with competency standards and basic competencies.

Types of teaching materials can be grouped into four, namely (1) printed materials, in the form of books, modules, *handouts*, student worksheets, photos/pictures, brochures, and so on; (2) audio teaching

materials, such as radio, *podcasts*, audio CDs, and others; (3) audio-visual teaching materials, such as videos, films, and the like; and (4) interactive teaching materials [10].

The learning process is a communication process, so to deliver teaching materials, learning media is needed. Media is an intermediary between the source of the message and the recipient of the message. Learning media according to *AECT* are all forms of channels that are used as a message delivery process [11]. Based on several opinions from experts, it can be concluded that the definition of learning media is anything that can convey messages through various channels, can stimulate the thoughts, feelings, and willingness of students so that they are motivated to create a learning process in accordance with the learning objectives to be achieved.

Learning media bridges differences in perception and interpretation of learning material. Learning media can be a guide to achieving learning objectives and assist educators in conveying the structure of learning materials. Learning media can improve the quality of learning carried out by educators in a comprehensive, innovative, interesting way, and grow the enthusiasm of students.

### **Literary Creative Writing: Poetry**

Poetry as a literary genre is different from prose. Poetry has the characteristics of condensing language. In poetry, words do not come out of memory. The words in the poem are born and reborn (formed) at the time of their own pronunciation [12]. Throughout its history, poetry has always changed due to the evolution of changing tastes and aesthetic concepts. However, Riffaterre argues, that there is one thing that remains in poetry, namely stating something indirectly, meaning to say one thing and mean another [13]. Based on several definitions of poetry according to experts, it can be defined that poetry is a variety of literary works that use linguistic events as a medium to express feelings or descriptions of a certain atmosphere [14].

The elements of poetry are emotions, imagination, thoughts, ideas, tone, rhythm, sensory impressions, word order, figurative words, density, and mixed feelings. In conclusion, there are three main elements of poetry, namely 1) things that include thoughts, ideas, or emotions; 2) the shape; and 3) the impression [15]. Everything is revealed by the medium of language. There are three aspects that need to be considered in poetry, namely as follows. First, the nature of art or the function of art; Poetry as a literary work has a dominant

aesthetic function. These beauty elements are poetic elements, such as poetry, diction, rhythm, and style of language. Second, density; poetry is an expression of the essence because poetry is compressed and dense, so the poet chooses words accurately. Third, indirect expression, meaning that the poem states something that means something else[16].

Poetry as a literary work, the aesthetic elements are dominant. These beauty elements are poetic elements, which include: rhyme, rhythm, style, and diction. The types of language styles include: sounds, words, sentences, and discourses [17]. Rakhmat Djoko Pradopo argues that poetry is an important recording and interpretation of human experience and composed in the most meaningful form[8]. In line with Richard that the essence of poetry contains an overall meaning which is a combination of theme, feeling, tone, and message [17].

Based on some of the opinions above, it can be concluded that the essence of poetry is a literary work that has a high aesthetic value and comes from the interpretation of human life experiences which are transformed into memorable forms as a result of the poet's imagination and ideas as outlined in specific typographical forms. Poetry itself is always changing. These changes are based on evolutionary development and human aesthetic concepts.

The elements of poetry according to Jabrohim et al. among others: 1) diction, 2) images, 3) concrete words, 4) figurative language, 5) verification, (6) typography, and rhetorical means. While the inner structure of the poem consists of four, namely 1) *sense* (theme or meaning) is the main issue raised by the poet (poetry writer); 2) tone is the attitude of the poet towards the reader or connoisseur of his work; 3) feeling (*rasa*) is the attitude of the poet towards the subject matter raised in his poem; and 4) the mandate is the goal in creating the poem [18].

### **Utilization of Instructional Media Canva**

*Canva* is a design application in the network (*online*) that provides a variety of features, such as posters, logos, brochures, flyers, presentations, graphics, banners, infographics, certificates, flyers, certificates, business cards, postcards, invitation cards, thank you cards, bookmarks, book covers, labels, newsletters, and much more[19]. The types of presentations available on *Canva* include educational presentations, creative, simple, business, advertising, marketing, technology, architecture, and so on [20].

The use of *Canva* in learning is one of the influences of the development of the industrial revolution 4.0 which requires educators and students to be *literate* technologically. This is also in accordance with the goals of *society 5.0*, where educators and students can utilize technology in the learning process. In addition, *Canva* is one of the media that can be used in the learning process in a practical way, is easy to make, and can attract the attention of students because of the variety of templates, features, and others. Pelangi also stated that the application *Canva* can be used as a visual literacy for students in learning Indonesian [20].

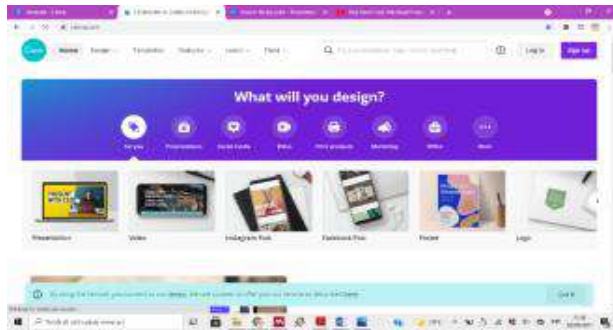
The advantages of *Canva*, include: 1) it has a variety of attractive template designs; 2) able to develop the creativity of educators and students in designing learning media because of the many interesting features; 3) save time in designing learning media; 4) have good image resolution and attractive presentation slide templates; 5) the design results can be downloaded in jpg, png, pdf format, and others; 6) the design results are automatically saved on *the Canva website* and can be shared on social media [21].

Although *Canva* has many advantages, it is not without its weaknesses. The following are the weaknesses in *Canva*, including: 1)-based *website* so it requires an internet connection to access; 2) the free version is limited in access, such as not being able to *export design files* with transparent backgrounds; 3) the feature *export design* with animated GIF or video is only available in the paid version; 4) there are similarities in user templates [21].

Here are the steps for creating a design *Canva*.

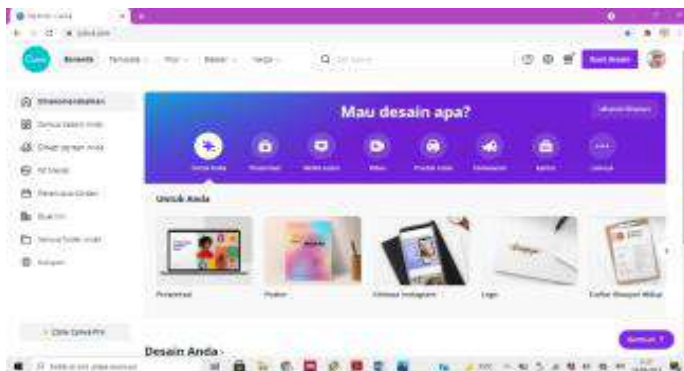
1. Go to the site *canva.com* and register for an account.

If you are already registered with account *Canva*, you can enter directly, but if you don't have an account, you must register first. How to register an account, select *sign up* using *email*, *google*, or *Facebook*. Then enter your full name, email, and *password*, if you *signed up* using *email*. If you *sign up* using *google* and *Facebook* then do *authorize access*.



**Figure 1. Opens the site *canva.com* and register an account**

2. Once you have an account, choose the design according to your needs using the application *Canva*. Designs to choose from include: logos, presentations, posters, and so on.



**Figure 2. Choosing a design *canvas***

3. Creating a presentation design  
 In creating a presentation design using *Canva*, select the presentation menu, there will be seen many templates that can be selected as desired. In addition, in presentation design *Canva's format*, you can upload directly from your existing file *powerpoint* that has been converted into *pdf*. The app *Canva videos* can also add recorded to explain each slide.

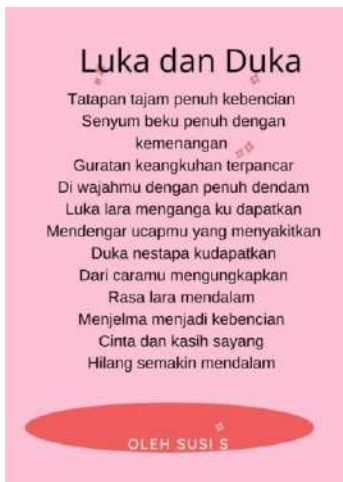


**Figure 3. Features of audio-visual recording in a Canva presentation**

### Implementation Utilization Canva

Utilization application *Canva* as a medium of learning, certainly is needed by teachers in order to provide maximum comprehension for learners, especially in the midst of a pandemic such as this. Based on the needs analysis for educators who experience several problems, including 1) the lack of understanding of educators regarding digital-based poetry writing learning media that supports online learning, causing boredom for students; 2) educators do not feel confident in creating a work, especially in writing poetry as a support for teaching materials; and 3) due to the Covid-19 pandemic, online learning has not been carried out optimally, it is still limited to providing "assignments *online*".

Based on the problems faced by these educators, training in creative writing of literature (poetry) and digital-based learning media was carried out to overcome boredom for students. As a result of the training, educators were able to improve their abilities and skills in writing poetry and develop them in the learning media *Canva*.



## Figures 4 and 5 Educator's Work of Poetry Poetry Instructional Materials

Figures 4 and 5 is the result of creative works of poetry educators as outlined in instructional media *Canva* for teaching materials of learning to write poetry. In addition to the teaching materials in the form of poetry creations above, here are also examples of teaching materials for poetry texts in the form of e-posters.



**Figure 6 Poetry Text E-Poster Series Using Canva**

Based on the explanation above, it can be concluded that the application *Canva* can help educators in designing interesting learning media. *Canva* is not only used to create logos, brochures, leaflets, and so on, but can also be used as a learning media for presentations and learning posters. Seeing the current situation and conditions, where the learning system is still carried out online (*online*) or *blended learning*, media is needed that attracts the attention of students, and does not cause boredom during online learning.

## Closing

Digital-based learning media is very much needed in today's technological developments. *Canva* can help educators to deliver interesting and not boring teaching materials. *Canva* can be developed as a form of technology that can support the learning process towards *society 5.0*, which is required to be able to provide knowledge based on *internet of things*. *Canva* is an internet-based application that has a variety of *templates* and interesting features that can be used to support learning based on technology, skills, creativity, and other benefits.



## Reference

- [1] T. Solihudin JH, "Development of Web-Based E-Module To Improve Achievement of Physics Knowledge Competence in HighStatic and Dynamic Electrical Materials," *SchoolWaPFI (Wahana Pendidik. Fis.*, vol. 3, no. 2, p. 51, 2018.
- [2] D. Wahyudi, "Development of E-Modules in Android-Based High School Mathematics Learning," *GAUSS J. Pendidik Mat.*vol. 2, no. 2, p. 1, 2019.
- [3] B Wisudo, L. Paat, J. Paat, and Etc., *Digital Education Strategy*Malang: Intrans Publishing, 2021.
- [4] E. Wibowo, "Development of E-Module Teaching Materials Using the Kvisoft Flipbook Maker Application," 2018.
- [5] NS Herawati and A. Muhtadi, "Development of interactive electronic modules (e-modules) in Chemistry class XI SMA," *J. Inov. Teknol. Educators.*, vol. 5, no. 2, pp. 180–191 , 2018.
- [6] REN Afrianti and A. Qohar, "Development of Contextual-Based E-Modules in Class XI Linear Program Materials," *J. Education Mat. and Science*, vol. 7, no. 1, p. 22, 2019.
- [7] S. Hamdy, *Discourse Guide & Musical Appreciation asi Poetry*. Yogyakarta: Student Center, 2015.
- [8] RD Pradopo, *Poetry Studies*. Yogyakarta: Gadjah Mada University Press, 1997.
- [9] Ministry of National Education, *Guidelines for Selecting and Composing Teaching Materials*. Jakarta: Ministry of National Education, 2006.
- [10] PZ Diana, "Development of Collaborative-Based Indonesian Textbooks for Strengthening Character Education in Higher Education," in *Dissertation*, Universitas Sebelas Maret Surakarta: Unpublished, 2016.
- [11] MA Hamid, R. Ramadhani , M. Juliana, M. Safitri, MM Jamaludin, and J. Simarmata, *Learning Media*. Medan: Our Writing Foundation, 2020.
- [12] R. Ratih, *Poetry, Women Poets and Their Creative Process*. Yogyakarta: Student Center, 2019.
- [13] M. Riffaterre, *Semiotics of Poetry*. Bloomington: Indiana University Press, 1979.
- [14] DM Citraningrum, "Writing Poetry Using Creative Learning Techniques," *J. General Jember*, vol. Vol.1, no. No.1, pp. 82–90, 2016.
- [15] S. Ahmad, *Involvement in Poetry*. Kuala Lumpur: Utusan Publications & Distributors SDN. BHD., 1978.

- [16] L. Altenbernd and Lislie L. Lewis, *A Handbook for the Study of Poetry*. London: Collier-MacMillan Ltd., 1970.
- [17] A. Wicaksono, *Literary Creative Writing and Some of Its Learning Models*. Yogyakarta: Garudhawaca, 2014.
- [18] HJ Waluyo, *Poetry Theory and Appreciation*. Jakarta: Erlangga, 1995.
- [19] RE Tanjung and D. Faiza, "CANVA AS A LEARNING MEDIA IN BASIC ELECTRICITY AND ELECTRONICS LESSONS Rahma Elvira Tanjung 1) , Delsina Faiza 2) 1," *J. Vocational Tek. Electron. and Information.*, vol. 7, no. 2, pp. 79–85, 2019.
- [20] G. Pelangi, "Utilizing the Canva Application as a Media for Learning Indonesian Language and Literature," *J. Sasindo Unpam, Vol 8, No 2, December 2020 Beneficiary.*, vol. 8, no. 2, pp. 79–96, 2020.
- [21] SP Astuti, "Development of Canva Media as Learning Media on Static Electricity Materials," vol. 3, no. 1, pp. 8–15, 2021.

# Postmethod Era and Its Implication to Language Teacher's Education

Purwo Haryono<sup>94</sup>

## Introduction

Language learning methods have gone through three phases, namely pre-method era, method era, and post-method era. In the pre-method era, the emerging methods were not based on linguistic and psychological theories. It was only in the era of methods that the emerging methods were already based on linguistic and learning theory. Many methods emerged in this second era, all of which claim to be the best methods. In this second era, language learning experts are trying to find the most effective method to teach language. The teacher acts as a user of teaching sequences that have been created by language learning experts. In the process of learning a foreign language, the teacher should not just ask students to listen to the teacher's explanation. Teachers must enable students to use language as a communication tool both in spoken and written form [1], [2] as well as technology and internet-based [3], [4]. In an effort to provide convenience in learning foreign languages, education experts have worked to create and manipulate foreign language learning methods with various approaches. Foreign language teachers must understand and apply various methods with their approach.

Methods are defined variously by several foreign language learning experts. In explaining the method, some language learning experts, such as [5], [6], [7], [8], always start by citing the notion of approach, method, and technique proposed by Anthony. They are related hierarchically. The approach has the highest place because it relates to a set of assumptions or theories of foreign language learning. The approach adopted by foreign language teachers is put into a method that contains a plan of learning steps that are implemented in the form of learning techniques in the classroom. If compared, the terms approach, method, and technique provide a clearer description. Approach in language learning is something that reflects a particular model or research paradigm which is called theory. The method is a set of procedures that provides directions on how to teach a second language or a foreign language. Meanwhile,

---

<sup>94</sup> Widya Dharma Klaten University

technique is a tool or activity implemented in the classroom which causes it to be the narrowest concept among approach, method, and technique [8], [6], [9].

Meanwhile, language theory and language learning really help teachers understand the parts of language learning. However, there is still a lack of explanation regarding the position of each framework and this has led to widespread dissatisfaction (Kumaravadivelu, 2006). Anthony himself admits that his framework can still be modified, considering that the differences between approaches and methods on the one hand and the differences between methods and techniques on the other are not very clear. The fact that many approaches and methods are used interchangeably in many references shows that there is no clear boundary between the two. Three distinctions, namely approach, design, and procedure are proposed by [6]. In this model the method acts as an umbrella. The approach is still interpreted as assumptions, beliefs, and theories about the nature of language and language learning that are axiomatic in nature. The approach contains the theory of language and the nature of language learning. The design contains several elements, namely general objectives and specific objectives of a method, syllabus models, types of learning activities, the role of students, the role of teachers, and the role of learning materials. Meanwhile, the procedure refers to the learning techniques, learning practices, and observed behaviors that are carried out by the teacher in the classroom when a method is used.

The terms and explanations from various language learning experts about approaches and methods overlap each other. Many criticisms were given against the method in this method era as no best method has been found. In fact, the new methods are a manipulation of the existing methods. With these conditions, it is natural that [10] discusses the post-method condition, namely about teachers ability to produce their own methods for learning in the classroom. The teacher must act as a professional's theory and personal's theory. Once entered in the post-method era, the teacher's role is very large in the success of language learning. Teachers must be critical and responsive to the needs of different students [11]. Teachers not only act as users of theory but also as providers of theory [1], [12] especially in today's computer age [13]. Based on his practical experience, a teacher can create his own theory and practice the theory he has produced. The impact of the emergence of the post-method era of course has an impact on language teacher education.

## **Discussion**

In the method era, confusion came about existing language learning methods because there was no easy way to group methods conceptually. Language learning methods can be grouped into three, namely (a) language-centered methods; (b) learner-centered methods; and (c) learning-centered methods [5]. Language-centered methods primarily concerned with language forms as offered by the Audiolingual Method. This method provides opportunities for students to practice linguistic structures that have been selected and ordered previously. Learner-centered methods relate to the needs, desires, and conditions of learners as offered by Communicative Language Teaching [14]. It tries to provide opportunities for students to practice the selected and sorted linguistic structures along with their communicative functions by doing activities that focus on meaning. The assumption held by adherents of learner-centered methods is that the mastery of form and function can encourage the mastery of the target language. In addition, students are expected to be able to use elements of formal and functional language to meet communication needs outside the classroom. According to this view, language development is more intentional than incidental.

Learning-centered methods are principally related to cognitive processes in language learning. These methods (e.g. the Natural Approach) provide opportunities for students to engage in interaction. According to experts, the learning-centered method of language development is not a nonlinear process, and therefore does not require a selection and sequencing process. It is the creation of conditions so that students are involved in meaningful learning. The theorists believe that learning a language will work best if it focuses on the learning process, and not on the language.

While, the post-method era is an era in which language teachers must immediately restructure their views on language learning and teacher education. This era requires rethinking on learning that occurs in the classroom using a pedagogical and ideological perspective with a constructivist approach [15]. In addition, this era also requires language teachers to reorganize the relationship between theory and practice of language learning. To explain the post-method era, there are three pedagogical parameters, namely parameters of particularity, parameters of practicality, and parameters of possibility [10], [16]. Particularity is the most important post-method pedagogical aspect. Pedagogy in the post-method era must be sensitive to a group of teachers who teach a group

of students with a specific purpose and a certain context [5], [10], [16]. Teachers must be sensitive to the individual context of the students, the institutional context in which the teacher teaches, the social context that surrounds them, and the cultural context in which learning takes place. Even, today game and google search have been used in language education [17], [18]. Otherwise, learning will not be effective and relevant. A language teacher must be able to assess local resources as well as the obstacles that exist around them in order to develop their knowledge and skills to assess local needs, observe teaching practices, evaluate outputs, identify problems that may arise, and last but not least, find solutions to problems that arise. This activity is a cycle that continues to rotate and this will affect the next principle, namely the parameters of practicality.

Parameters of practicality are primarily closely related to the relationship between theory and practice. More specifically, this parameter relates to a teacher's skill in monitoring the effectiveness of his own learning [5], [10]. By practicality, a method must be applicable to real situations. Thus, theory must relate to practice. In other words, a theory will be useless if it cannot be applied in practical activities [16], [19]. With this parameter a teacher is encouraged to build a theory from the practice he has done, then put into practice what he has theorized himself. By deriving and building theory from his own practical experience, it is hoped that he will be able to understand and identify problems that arise which in turn can be handled well in the learning process. By utilizing previous experiences and experiences that will occur, a teacher will feel aware of his own problems which refer to good learning practices. This is referred to as a sense of plausibility [5], [16].

Parameters of possibility implies that the method must be appropriate and suitable socially, culturally, and politically. In addition, this parameter is also related to language ideology and student identity [5]. Teachers and students come to class with all their views and thoughts and personalities. Personality in the classroom is expected to be the same as his daily personality outside the classroom. The experiences brought into the educational setting are built by the social, economic, and political environment and not only based on experiences gained in the classroom [20]. Parameters of possibility treats the experience gained from language learning as a source to form a teacher's self-identity. More than just an educational experience, language use and learning offers teachers an opportunity to build identity and self-subjectivity. This is said by Weeden as

quoted by [5], [10], [21] that language is a place or something where forms of social organization are formed and also the social and political consequences that occur. In addition, language can also act as a construct about the self and is subjective [19].

Many parties are involved in the entire educational process, including administrators, policy makers, curriculum designers, teacher education institutions, and textbook or textbook writers. Teachers still play a very important role considering that teachers are tasked with building learning outcomes. Challenging priorities seeks to build a teacher education program with a global perspective that emphasizes activities to develop teacher knowledge, accelerate the freedom to develop theory and practice, understand the context of local situations, improve teacher intellectuality, and master learning models [22], [10], [23]. In the method era, the teacher only acts as a user of the theoretically developed method by experts. However, in the post-method era the teacher is expected to play a dual role considering that teachers are human beings who have a lot of information to build their own theories [24], [5]. Thus, teachers are expected to be able to identify problems as well as to solve them. Teachers are expected to be able to create their own methods according to their respective backgrounds and have the opportunity to facilitate students to learn better and help them engage in the learning process. The ability of a teacher is not determined by the theorists, but is highly dependent on the teacher himself [25], [23].

To answer the challenges that teachers must face in the post-method era, teacher education should be directed at enabling prospective teachers or teachers to be able to understand themselves and their environment. Environment can mean social, political, cultural, and other environments. Prospective teachers are not only equipped with knowledge about methods but are also directed so that prospective teachers and also teachers can apply their knowledge and experience in building methods that are most suitable for their respective backgrounds. Thus, it is hoped that teachers can teach students better [26], [27]. Even as an emphasize of the above statement, it is said by [7] that the learning approach applied by a teacher is not something that is static, but must be dynamic which can change at any time based on experience in teaching students. The approach applied by the teacher can be different because the approach is dynamic which, of course, can be observed and can be used as experience. In addition, the approach applied by the teacher

can be researched to find new findings rather than just evidence from a research result conducted by learning theorists [22], [21], [14].

## Conclusion

Several important points can be drawn relating to the methods associated with teacher education. Despite receiving many responses to the theory of approaches, methods, and techniques put forward by Anthony, many language learning experts still admit that the theory has opened their eyes for further research related to language learning methods. Historically, the development of language learning methods can be categorized into the pre-method era, the method era, and the post-method era, each of which has its own perspective. In the pre-method era, language learning methods were less or not based on linguistic theory and learning theory. In the method era, the methods produced by language learning experts were already based on linguistic theories and learning psychology. The teacher's role is as a user of the theory produced by method experts. In the post-method era, the teacher has a very important role, namely acting as a theory builder as well as a user of his own theory. The post-method era certainly has an impact on the education of teachers and prospective teachers. Teacher education must be directed at understanding and applying the paradigm that a teacher must always adapt language learning methods according to the context.

## References

- [1] Z. Zeng, "Construction of EFL Student Teachers' Beliefs about Method: Insights from Postmethod," *English Lang. Teach.*, vol. 11, no. 1, 2017, doi: 10.5539/elt.v11n1p93.
- [2] Q. N. Nhat and B. P. Hung, "The dogme approach: A radical perspective in second language teaching in the post-methods era," *Journal of Language and Education*, vol. 6, no. 3. 2020, doi: 10.17323/jle.2020.10563.
- [3] F. M. AL-Madani, "Student Perception of Traditional English Teaching Methods (CLT approach) and Comparison to Modern Methods (Using Technology)," *Int. J. Educ. Inf. Technol.*, vol. 15, 2021, doi: 10.46300/9109.2021.15.5.
- [4] T. Budiman and F. Franky, "The Relationship Pattern of Internet Usage Frequency, Generation Z Characteristics, and Teaching Method in the Millennium Era," *Int. J. Interact. Mob. Technol.*, vol. 15, no. 18, 2021, doi: 10.3991/ijim.v15i18.24555.
- [5] B. Kumaravadivelu, *Understanding language teaching: from*



- method to postmethod*. London: Lawrence Associate, Inc., 2006.
- [6] J. C. Richards and T. S. Rodgers, *Approaches and methods in language teaching*. Cambridge: Cambridge University Press, 2014.
- [7] H. D. Brown, "English language teaching in the 'post-method' era: towards better diagnosis, treatment, and assessment," in *Methodology in language teaching: an anthology of current practice*, J. C. Richards and W. A. Renandya, Eds. Cambridge: Cambridge University Press, 2002, pp. 9–18.
- [8] M. Celce-Murcia, "Teaching English as a second of foreign language," in *Language teaching approaches: an overview*, M. Celce-Murcia, Ed. New York: Heinle & Heinle, 2001, pp. 3–11.
- [9] J. C. Richards, "Longman Dictionary of Language Teaching and Applied Linguistics," *Longman Dict. Lang. Teach. Appl. Linguist.*, 2013, doi: 10.4324/9781315833835.
- [10] B. Kumaravadivelu, *Language teacher education for global society: a modular model for knowing, analyzing, recognizing, doing and seeing*. New York: Routledge, 2012.
- [11] P. N. Valdez, "Research in critical pedagogy: Implications for English language classrooms in Asia," *PASAA*, vol. 60, 2020.
- [12] M. Loey, G. Manogaran, M. H. N. Taha, and N. E. M. Khalifa, "A hybrid deep transfer learning model with machine learning methods for face mask detection in the era of the COVID-19 pandemic," *Meas. J. Int. Meas. Confed.*, vol. 167, 2021, doi: 10.1016/j.measurement.2020.108288.
- [13] N. S. Ivasiv, M. S. Kozolup, O. V. Oleniuk, N. V. Rubel, and N. Y. Skiba, "Current methods for assessing the level of foreign language proficiency of university students," *Int. J. Learn. Teach. Educ. Res.*, vol. 19, no. 10, 2020, doi: 10.26803/ijlter.19.10.17.
- [14] A. Marzban and F. Karimi, "Applicability of CLT and Postmethod Pedagogy in Iranian Context of ELT: Expert Teachers' Perspectives," *Turkish Online J. Qual. Inq.*, 2018, doi: 10.17569/tojqi.329991.
- [15] T. Brett, "Principled Eclecticism in the Classroom: Exploring the use of Alternative Methodologies in ELT," *Arab World English J.*, no. 2, 2021, doi: 10.24093/awej/mec2.15.
- [16] R. C. Bacus, "Teachers' beliefs, praxes, and post-method pedagogy in English language teaching," *Int. J. Learn. Teach. Educ. Res.*, vol. 20, no. 1, 2021, doi: 10.26803/ijlter.20.1.5.
- [17] Y. L. Huang, D. F. Chang, and B. Wu, "Mobile game-based learning with a mobile app: Motivational effects and learning

- performance," *J. Adv. Comput. Intell. Intell. Informatics*, vol. 21, no. 6, 2017, doi: 10.20965/jaciii.2017.p0963.
- [18] S. Han and J. A. Shin, "Teaching Google search techniques in an L2 academic writing context," *Lang. Learn. Technol.*, vol. 21, no. 3, 2017.
- [19] X. Sun, "Revisiting postmethod pedagogy: Adopting and adapting Socratic circle to secondary EFL teaching," *TESOL J.*, vol. 12, no. 3, 2021, doi: 10.1002/tesj.601.
- [20] P. Poláková and B. Klímová, "Mobile technology and generation Z in the English language classroom – A preliminary study," *Educ. Sci.*, vol. 9, no. 3, 2019, doi: 10.3390/educsci9030203.
- [21] M. A. A. Khan, "Analysis of EFL Teaching in Pakistan: Method and Strategies in the Postmethod Era," *REiLA J. Res. Innov. Lang.*, vol. 2, no. 3, pp. 93–100, Dec. 2020, doi: 10.31849/reila.v2i3.4802.
- [22] D. B. U. Devi, "Efficacy of Situation Specific Need-Based Micro Approaches of Post Method Pedagogy Application in L2 Learning," *Int. J. Res. Appl. Sci. Eng. Technol.*, vol. 9, no. 9, 2021, doi: 10.22214/ijraset.2021.38089.
- [23] J. Y. H. Chan, "Four decades of ELT development in Hong Kong: Impact of global theories on the changing curricula and textbooks," *Lang. Teach. Res.*, vol. 25, no. 5, 2021, doi: 10.1177/1362168819865563.
- [24] R. Angelo, "Neoliberal ideology, discursive paradox and communicative language teaching," *Policy Futur. Educ.*, vol. 19, no. 7, 2020, doi: 10.1177/1478210320971539.
- [25] G. Hall, "Theoretical insights for a Postmethod era," in *Exploring English Language Teaching*, 2020.
- [26] F. Orabueze, H. I. Okafor, U. U. Okonkwo, M. M. Chinonso, and O. Ekwueme, "Methods and techniques of teaching English and German classes in Nigeria during the Covid-19 pandemic era," *XLinguae*, vol. 14, no. 1, 2021, doi: 10.18355/XL.2021.14.01.08.
- [27] K. Allmann and G. Blank, "Rethinking digital skills in the era of compulsory computing: methods, measurement, policy and theory," *Inf. Commun. Soc.*, vol. 24, no. 5, 2021, doi: 10.1080/1369118X.2021.1874475.

# **The Existence of Religion, Scripture, and Islamic Thinkers in the Era 5.0**

Rafiudin

## **Introduction**

The debate on the existence of religion in the 5.0 era has become interesting discussions on social media lately. The advanced of information technology that has spoiled humans is the strongest reason for material worshipers to invite others to leave something useless. Unfortunately, that something is a religion which in the belief of the majority people in Indonesia is the basic of life. Various studies that conclude the importance of religion seem to be ignored [1]-[3] and only become a subject of discussion in academia without application in the field.

The development of a sharp mindset among teenagers largely corners the religious people who have been trying hard to build human civilization so which is based on religious beliefs and leaves other paths besides the path that has been arranged by God in religious teachings. Whereas adolescence is considered as the fastest period to be able to access religious knowledge along with increasing intellectuality [4]. The rapid movement about mindset and perspective changes of today's young generation, therefore reviewing the understanding of religion, its functions and the scripture that become the guidance of life among Muslim thinkers needs to be discussed continuously so that each generation has understood well about his [5]. Especially the understanding of religion.

Religion is not only act as a routine which is considered monotonous, but needs to be viewed from a comprehensive perspective in order to produce a new paradigm in social life. Dialectics in religion with the counseling method [6], [7] is the main focus in an effort to reduce a case that has recently spread with the spirit of unlimited happy life. Religion becomes a reference to show its existence in answering the existing problems.

## **Discussion**

### **Dialectic in Religion**

Max Muller argues that a complete definition of religion has not been reached because research on religion continues and experts are still investigating the origins of religion [8]. An incomplete understanding of religion is often used as the main reason for

destroying the existence of religion among the younger generation. Something that has not been finished to be studied still leaves the possibility of bad things for every adherent of a certain religion in the world.

Jack David Eller argues that religion is a part of human life. The existence of definitions and concepts depends on what is learned with all existing aspects. There is no single definition that is able to capture the depth of the meaning of religion, but it has contributed greatly to everyone's current understanding [9]. Eller's thoughts on religion seem simple, moreover, the existence of religion seems to be left to each person. This, of course, can be used as a strong reason that religion essentially depends on who interprets it without anyone having important rights or domains in defining the nature of religion.

Edward Burnett Tylor argues that the minimal definition of religion is "the belief in spiritual beings" [10]. The existence of religion in this meanings shows that humans consist of two dimensions, namely the physical realm and the spiritual realm where religion can only fill the spiritual realm while the physical realm can be filled with something more productive such as technology.

According to Erich Fromm, religion is any system of thought and action shared by a group of people that provides a framework of direction (life) and objects for worship for those who are members of that group personally [11]. Religion in this definition is more inclined to the understanding of a particular group of people or ethnicity and nation. Each group can define religion by existing experience and mutual agreement among them. Religion cannot be generalized to all religions [12].

Emile Durkheim, Marx, and Weber argue that religion is an unseen realm (fundamentally an illusion) that cannot be known and cannot be thought of by the human mind itself [13]. Religion in this meanings is more likely to be pessimistic about understanding religion, even more so that religion is far from logic and human thought patterns so that people who doubt the existence of religion will feel more supported by this kind of thinking.

According to R. Stark and CY Glock, religiosity is obedience and commitment to religion which includes several elements including church membership, belief in religious doctrines adopted, life ethics, attendance at worship events and views and others that show obedience to religion [14]. This view is closer to a complete understanding of religion. Divine religions understand religion more

in a two-way view, namely the existence of spiritual and physical in religion.

In the 5.0 era where technology has become a part of culture in human life, it demands a more holistic existence of religion. The paradigm of thinking of the younger generation becomes reduced in responding to human success in all fields. The ability to control technology is considered to be the cause of success and religion is not a good tool to lead someone to be successful.

### **The Bible as a Support for the Existence of Religion**

The first treatment carried out by religious adherents to their scriptures was translation and then the contents of their teachings in the form of symbols, rites, and worship procedures were gradually carried out as a form of purification of the scripture which they believed came from God. The majority of Christians also believe that their scriptures are also the words of God [15]. The nature and definition of scripture, in it contains historical, moral, legal, poetic, philosophical values, directs for worship, there are myths, legends, and predictions [16].

The scriptures contain many things such as the history contained in the Hebrew scriptures and the Japanese Kojiki Shinto, it is necessary for humans to understand that God or gods work in history, so anyone need not be afraid of change. There are also scriptures that contain laws and rituals such as Hebrew and Confucian, it is necessary so that humans can maintain the traditions of living in the past when entering the challenges of change. The scriptures also contain rules and attitudes which are better known as morals so that humans can live properly like the teachings of Qur'an. The scriptures also contain wisdom and poetry, also contain philosophy such as some parts of the Upanishads from the Vedas and Buddhist Sutras to help people realize and understand the meaning of the timeless in the midst of time [17]. The scripture presents readings that contain collections, summaries, and insights rather than philosophical systematics or theological treatises [18].

The scripture has characteristics, among others, must be written, to make its way into worship, contain authority of the text, have a sacred meaning. The scripture is considered important as a symbol of religious community identity. Promotions to spread literacy are carried out by adherents. Religious leaders are confirmed to be proper interpreters and certify that the religious path is the way of salvation for everyone. Scripture can also be used as legitimacy. The

Vedas, for example, were not written until modern times. This was done to maintain his great sacredness. The book was transmitted orally from father to son, teacher to student over several generations [19], [20]. The background of the scriptures, such as Hebrew Judaism, Arabic in Islam, or Sanskrit in Hinduism gives its own color and is considered the most powerful if spoken by the original tongue of the adherents of the scripture [21].

Henry More said that scripture is open to rational interpretation. The example of the Qur'an is used for several reasons, namely its content can be tested logically (Primarily cognitive), its teachings can be applied as a means of worshiping Allah (Ritual/public worship), the Qur'an commands to respect it (Venerate). The true scriptures do not contrary to reason. The scripture adds to the understanding of God, the existence of God, the immortality of the soul (soul), the existence of the spirit, furthermore about philosophical truth. The Vedas, for example, also consistently teach character [21].

The existence of religion is in the pages of the scripture which are the guidelines for the life of religious people. The relationship of one generation with the next generation is measured by how much the generation has understood the scriptures that left by the previous generation. A new understanding will emerge when there is a deadlock in understanding the scriptures that have been embraced during this time.

### **Islamic Thinkers become Religious Guides**

M. Abdul Karim, said that as long as the thoughts pursued by every Muslim thinker, in any field (theology, worship, politics, ethics, philosophy, mysticism, economics, etc.), are within limits that do not conflict with the teachings of the Qur'an and Sunnah of the Prophet, then this thought can be called Islamic thought [22]. In essence, every generation from before the arrival of Islam to the present has its own unique thoughts, both in terms of processes, patterns, and results.

In the XVIII century at a time when Western Europe was amazed by Islamic civilization. The Muslims actually feel that their world is in decline. It turns out that such an attitude began to spread around the year 1000 H or 1590 M, when many Muslims thought the life of the world would end [23]. Symptoms of the decline of Islam appeared in the XI century and continued until the XVIII century. At the beginning of the nineteenth century the Muslims rebuilt the glory of Islam with the idea of modernism and reformism or the idea of

renewal in Islam with the motto "back to the Qur'an and Al-Hadith. Renewal of religion is essentially a renewal of the spirit of Islam by getting rid of all the weaknesses and ignorance that have hit the hearts and minds of the Muslims [24].

The first reformer scholar was Ibn Taimiyah (1263-1328) with his student and friend, Ibn Qayyim al-Jauziyah (1292-1350). Despite their movement for approximately four centuries no one responded [25]. One hundred years earlier, a reformist, Al-Ghazali, had also been born [24]. He firmly stated: Do not you know the truth through the characters, but know the truth, you will automatically know the experts. Look for the truth through analysis, not through the attitude of following (taqlid), because wisdom (al-hikmah) is the lost property of a believer, therefore he has the right to take it wherever he finds it [24]. In Saudi Arabia (Nejd) there was Muhammad bin Abdul Wahab (1703-1787) who was famous for the Wahhabi movement or the muwahhidah group, assisted by his friend, the statesman Ibn Sa'ud Ibn Abdul Aziz [25].

Muhammad Abduh (1849-1905), and Rasyid Rida (1856-1935) were supporters of the *Muhyi Astaris Salaf* movement, better known as the *Salafiyah* movement around the nineteenth century, which was pioneered by Sayyid Jamaluddin Al-Afghani, known as a wise man from the east in Arabic literature [23]. He was born near Kabul, Afghanistan in 1838 and died in Istanbul, Turkey in 1897. The aim of the movement was to uphold the glory of Islam and the Muslims (izzul Islam Wal Muslimin) [25].

KH Ahmad Dahlan (1868-1923), the founder of Muhammadiyah (1912) was a national figure who had his own impression of *Tafsir Al-Manar* by M. Abduh and Rasyid Rida. The reform system in Muhammadiyah is also of course dominated by the thoughts of these two figures [25]. One of them is the *Tajdid* movement [26]. A word used by the renewal movement in the Islamic world other than the word *Ishlah* at that time [27]. KH Hasyim Asy'ari (1875-1947 AD), the founder of Nahdlatul Ulama (1926) also admired the rationality expressed by Muhammad Abduh in his *Tafsir al-Manar* taught by Sheikh Ahmad Khatib Al-Minangkabawi

Muhammad Abduh, the Egyptian-born reformer, was graduated from Al-Azhar University with the title of 'Alim and is a lecturer at his University [25]. Abduh changed Al-Azhar to be similar to universities in Europe. Abduh succeeded in entering general subjects such as mathematics and earth sciences at Al-Azhar [27]. Abduh's thoughts against dualism or dichotomy in the religious and

public education systems [27], were successfully inherited by KH Syam'un through Abduh's favorite student, Rasyid Ridha, a Lebanese-born reformer who had waged a war of thought (ghazwatul fikr) against the absolute government of the Ottoman Empire, England, and France [25]. KH Syam'un (1883-1949), the founder of Al-Khairiyah (1925) received enlightenment and direct guidance from Muhammad Rasyid Ridha. Ridha's thought is estimated to dominate the perspective of KH Syam'un in empowering human resources at the Al-Khairiyah Islamic Boarding School.

History records that the thinkers and figures of Islamic reform are very popular. Thoughts and ideas for renewal continue to be studied. Even its influence can be felt until now. In the Arab world, known figures Muhammad bin Abdul Wahab, Muhammad Abduh, Rashid Ridha, and so on.

In India and Pakistan, there are known reformers such as Muhammad Iqbal, Ali Jinnah, Kalam Azad, Ahmad Khan, Jamaluddin al-Afghani, and others. The same thing happened in Indonesia. The reformers who are quite popular can be mentioned, among others: KH Ahmad Dahlan, KH Hasyim Asy'ari, then followed by other contemporary figures such as Harun Nasution, Nurcholis Madjid, Abdurrahman Wahid, Amin Rais, and so on.

## **Conclusion**

Thinkers with their religion and scriptures these are used as guidelines for life become the spirit of a shift in civilization towards a more realistic direction and is built on the basis of faith. This shift tries to reduce all the values of fantasy, fiction, and superstition that exist among Muslims.

Three dimensions starting from thinkers, scriptures, and religion will create a new civilization cycle, especially in the 5.0 era. The paradigm of Muslim thinkers who are solid and mature in terms of thought is not always directly proportional to the context that is built in a civilization.

The placement of a thought in the 5.0 era requires an assimilation effort with rapidly developing technology and an increasingly rapid flow of information. The efforts of every Muslim thinker in fighting for a new Islamic civilization in terms of all fields (economic, educational, and social) will reach the pinnacle of glory.

One indication will be seen if the assimilation of community thoughts and culture 5.0 can be adopted by millennials who have the complexity of understanding religion and scriptures that are used as



guidelines. The problem of understanding religion is the main measure of the level of achievement of an Islamic cultural portrait in the future.

## References

- [1] T. R. Noor, "Remaja dan Pemahaman Agama," *Vicratina*, Vol. 3, no. 2, pp. 54-70, 2019.
- [2] K. Hidayat, *Agama untuk Peradaban: membumikan etos Agama dalam kehidupan*. Tempat: Pustaka Alvabet, 2019.
- [3] I. Arifudin, "Integrasi Sains dan Agama Serta Implikasinya terhadap Pendidikan Islam," *Edukasi Islamika*, Vol. 1, no. 1, pp. 161-180, 2016.
- [4] R. D. Fitriannah, "Perkembangan Jiwa Agama pada Anak (Analisis Kajian dan Pemikiran dalam Psikologi Agama)," *Al-Fitrah*, Vol. 2, no. 2, pp. 331-340, 2019, doi: 10.15548/tajdid.v24i1.2276
- [5] Junaidi and Hasanah, "Memahami Islam secara Utuh dan Implikasinya dalam Dunia Pendidikan: Kajian Pendekatan Fenomenologis Annemarie Schimmel," *Edupedia*, Vol.6 no.1, pp.9-20, 2021, doi: 10.35316/edupedia.v6i1.1357
- [6] Z. D. Muhammad, *Pembinaan Nilai-nilai Agama Islam melalui Bimbingan dan Konseling di SMA Muhammadiyah 8 Cerme Gresik*, 2021.
- [7] S. Jafari, "Religion and Spirituality Within Counseling/ Clinical Psychology Training Programmes: A Systematic Review," *Taylor & Francis Online*, Vol.44, no. 3, pp. 257-267, 2016, doi: 10.1080/03069885.2016.1153038
- [8] A. Bakhtiar, *Filsafat Agama*, Jakarta: PT. Rajagrafindo Perasada, 2007.
- [9] J. D. Eller, *Introducing Anthropology of Religion: Culture to the Ultimate*, Oxon: Taylor & Francis, 2007.
- [10] F. Bowie, *Theories and Controversies, Antropologi of Religion*, Massachusetts: Blackwell Publisher, 2000.
- [11] K.S. Yogiswari, "Konsep Ketuhanan dalam Filsafat Erich Fromm (1900-1980)," *Sanjiwani*, Vol.12, no. 1, pp.13-27, 2021.
- [12] T. Ghashghaei, " Hossein Atrak' A Critiquial Study of Erich Fromm's View on Causes of Human's Tendency to Religion," *Journal of Religious Thought*, Vol. 13 no. 47, pp.75-94, 2013, doi: 10.22099/jrt.2013.2457
- [13] Jr. T.F. Godlove, *Teaching Durkheim*, New York: Oxford University Press, 2004.

- [14] R. Robertson, *Sociology of Religion*, Penguin: Harmondsworth, 1993.
- [15] A. Hessayon and N. Keene, *Scripture and Scholarship in Early Modern England*, England: Ashgate Publishing, 2006.
- [16] N. Lasmana and S. Ahmad, "Al-Qur'an dan Tiga Kitab Suci Samawi Lainnya, *Jurnal Asy-Syukriyyah*," Vol. 18, no. 1, pp. 39-52, 2017, doi: 10.36769/asy.v18i1.70
- [17] LLC, DWJ Books, *The Encyclopedia of World Religions*, New York: An imprint of Infobase Publishing, 2007.
- [18] G.L. Jardim, *Recovering the female voice in Islamic scripture : women and silence*, England: Ashgate Publishing Limited, 2014.
- [19] M. Awanita, "Sistem Pendidikan Hindu dalam Kitab Suci," *Pasupati*, Vol. 3 no. 1, p.39, 2014.
- [20] K.B. Sastrawam, "Filsafat Ilmu Pengetahuan Kitab Suci Weda," *Genta Hredaya*, Vol. 2 no. 1, 2020.
- [21] K. M. Jaya and A. E. T.R. Ni Made, "Kitab Suci Veda sebagai Sumber Pendidikan Budi Pekerti," *Guna Widaya*, Vol. 8, no. 20, pp.105-114, 2021.
- [22] M.A. Karim, *Sejarah Pemikiran dan Peradaban Islam*, Yogyakarta: Pustaka Book Publisher, 2007.
- [23] E. Mortimer, *Islam dan Kekuasaan*, Penerjemah, Enna Hadi dan Rahmani Astuti, Bandung: Mizan, 1984.
- [24] T. A. B. Surur, *Imam Al-Ghazali Hujjatul Islam*, Penerjemah, LPMI, Solo: CV Pustaka Mantiq, 1988.
- [25] M. Kamal et al., *Muhammadiyah Sebagai Gerakan Islam*, Yogyakarta: Persatuan Yogyakarta, 1988.
- [26] M. M. Abror, "Muhammadiyah dan Kesatuan," *Suara Muhammadiyah*, No.19, pp. 1-15, 2013.
- [27] R. Permana, *Sejarah Al-Khairiyah*, Cilegon: PB Al-Khairiyah, 2017.

# Realization of Online Learning in the Perception of Junior High School Student

Rizka Harfiani<sup>95</sup>

## Introduction

The pandemic in Indonesia forced face-to-face teaching and learning activities in schools to be stopped[1]. During the pandemic, students, teachers, and parents have a role in carrying out educational activities. Teachers have to rack their brains and try hard to adapt to technology and try to build an atmosphere of maximum engagement with students and parents[2]. Learning online is a challenge for the Indonesian people, not only because of technical problems, but also other problems that are quite energy-consuming[3].

The very fast change in the learning system, from face-to-face at school to online learning, without being accompanied by adequate preparation beforehand, resulted in many stuttering faced[4]. There are four different things in the implementation of learning during the pandemic, namely classroom arrangements based on zones, adhering to health protocols to prevent the transmission of covid-19, prohibition of coming to school for school residents who have comorbidities, and school readiness in accordance with applicable regulations[5]. Teachers have an additional role in implementing pandemic learning, namely ensuring the achievement of educational goals and the fulfillment of academic and non-academic targets, teachers must also ensure the safety of students physically and psychologically, teachers must provide emotional support for students, parents, and families, and be able to develop good cooperation with school principals, parents/families, and students in the education process[6].

During the pandemic, the world relies a lot on digital technology which provides a lot of convenience in providing various information, including also in the implementation of online learning[7]. Distance learning which was carried out during the pandemic, had positive and negative impacts. There are six negative impacts, namely the threat of dropping out of school, decreased learning achievement, children have the potential to become victims of domestic violence, limitations of gadgets and internet quotas,

---

<sup>95</sup> Universitas Muhammadiyah Sumatera Utara, Medan

children are at risk of learning loss and lack of socialization. While the positive impact of learning distance is that children have a lot of time with their families, varied learning methods, children are sensitive and adapt to changes, children must explore technology, and some children feel comfortable studying at home[8].

The positive responses of students in the implementation of online learning are increased student motivation in learning, high levels of student satisfaction, increased student interest in learning, and high student responses to the implementation of online learning[9]. Online learning can also be accessed flexibly, anywhere and anytime[10]. Online learning is also able to improve student activity in discussions for the better[11]. Increasing the use of technology in learning makes them more independent, inhibits the spread of the corona virus, saves transportation costs and pocket money, is closer to family and can help parents work while studying[12]. The results showed that all aspects contained in the student responses showed good categories, this indicates that online learning is effectively used during the covid-19 pandemic[13].

While students' negative responses to online learning, they consider online learning to be unattractive because some materials are difficult to understand, and they cannot cooperate with their friends. The tasks given are generally in the form of independent tasks (not in groups), so this is considered ineffective. Problems are also encountered when studying at home, such as slow network, blackout, difficulty asking questions, difficulty understanding some lessons, lack of teacher guidance, many assignments, limited quotas, unfavorable home atmosphere, some lessons cannot be practiced[12]. The results of student responses to online learning are also less pleasant, the problems faced are due to limited quotas, application errors and lack of guidance from teachers. In addition, they also rarely meet friends, cannot discuss directly, find it difficult to receive material and the number of assignments given[14].

The implementation of online learning in schools has encountered many problems experienced by students, such as poor internet connection, reduced learning motivation, difficulty concentrating and the many tasks assigned by the teacher. Overall, students prefer traditional learning compared to online learning, but on the positive side students feel that online learning is more structured and they are more confident when discussing[15].

Factors supporting the effectiveness of online learning are the carrying capacity of network access and the ability of devices to access

the internet[16]. In addition, the supporting factors in online learning are government policies, teacher support and learning facilities, such as digital technology, providing free quotas, expanding internet access, and providing learning facilities. While the inhibiting factors include students not understanding the use of learning media used by teachers[17]. The success of online learning really depends on several integrated components, such as students, educators, learning resources, and the technology used. While the weakness of online learning is the decreasing level of student discipline, lack of internet access, lack of social interaction and this is a common challenge for educational organizations and stakeholders[18].

The results of the evaluation of student learning activities that compare the grades and interaction patterns of students before and during the pandemic, show that during the pandemic there was a decline in student achievement, low student participation, and very drastic changes in student behavior, compared to the period before the pandemic[19].

The cause of many students who find it difficult to understand subject matter using the online system is due to the variety of student learning styles, in addition to the problem of slow internet signals and quota fees that must be spent for online learning[20]. Therefore, in online learning, teachers should be more effective in using e-learning which contains more complex material as an optimal learning tool and resource for students[21]. One of the efforts to increase student satisfaction in learning is to further improve the quality of the implementation of the use of e-learning[22]. The three critical success factors in delivering knowledge online are the sophistication of appropriate technology, educators who master digital technology, and the use of technology in the perspective of students. Educators will play a central role in online learning, where their role is as one of the learning catalysts and knowledge navigators[23].

Based on the description of the literature above, it is known that the online learning process has both positive and negative sides. Many aspects affect the implementation of online learning. For this reason, it takes a lot of research from different conditions, so that it can provide an overview of the implementation of online learning in Indonesia. In this study, researchers were interested in observing the realization of online learning in students' perceptions, because students as learning objects directly felt the impact of the online learning system. So it is important for us to know what they experience and feel during the online learning process. The

perception of students who study in a city environment that has more complete facilities and does not experience obstacles in internet access is certainly very different from students in rural areas who still have difficulty accessing the internet, the obstacles they face are more varied, for that in this case the researchers took respondents, namely students who are in rural locations, so they can take pictures of the problems they face in the implementation of online learning during the pandemic.

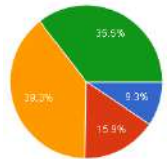
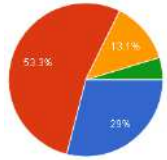
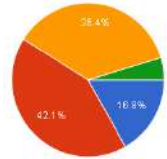
### Discussion

The focus of this research is on the implementation of online learning based on student responses regarding its implementation, the understanding gained, skills in using digital media, convenience in online learning from home, and the tasks assigned by the teacher during the online learning process. The following is a description of the research findings based on a statistical-descriptive review, which the researchers present in tabular form:

**Table: Results of Student Responses to Online Learning**

Questionnaire	Number of Respondents	Percentage (%)	Category (%)	Diagram
How do you feel about online learning?				
<ul style="list-style-type: none"> <li>● Very unpleasant</li> <li>● Unpleasant</li> <li>● Pleasant</li> <li>● Very pleasant</li> </ul>	46	2,99	83	
<b>Amount</b>	<b>107</b>	<b>00</b>	<b>100</b>	
How well do you understand the material presented by the teacher in online learning?				
<ul style="list-style-type: none"> <li>● Really don't understand</li> <li>● Don't understand</li> <li>● Understand</li> <li>● Very understanding</li> </ul>	37	4,58	84	
	53	9,53	16	
	17	5,89		
	0	,00		

<b>Amount</b>	17	10	10	
Can you use digital media in online learning?				
● Really can't	1	1,82	1	
● Can not	1	1,06	1	
● Can	1	1,45	1	
● Really can	1	57	1	
<b>Amount</b>	17	10	10	
Do you feel comfortable studying online from home?				
● Very uncomfortable	1	1,97	1	
● Uncomfortable	1	1,27	1	
● Comfortable	1	1,08	1	
● Very comfortable	1	57	1	
<b>Amount</b>	17	10	10	
What about the assignments given in online learning?				
● Not very burdensome	1	35	1	
● Not burdensome	1	1,89	1	
● Burdensome	1	1,25	1	
● Very burdensome	1	1,51	1	
<b>Amount</b>	17	10	10	



Based on the results of observations and interviews, it is known that Muhammadiyah 47 Junior High School organizes an online learning system starting in March 2020, where Indonesia is starting to experience a period of the covid-19 pandemic. In the first semester of the learning system, there were two methods, namely online learning and home visits. Meanwhile, in the next semester, because online learning was deemed less effective, a learning system was carried out in schools with a limited face-to-face method. This means that students study in schools in waves. Wave division based on class division. Each class is limited to only 50% who can enter the class. So

that there is a division of learning time, namely the first week 50% of students can come to school to carry out learning and the rest continue to learn from home. Meanwhile, the following week, there was a change of students who could come to study at school. This was done by the school as a solution to accommodate the aspirations of students, parents, and teachers who wanted the learning process to return to normal conditions, namely the implementation of learning in schools.

In this study, researchers focused on the realization of online learning in students' perceptions. To analyze the research data that has been obtained, the researcher will discuss one by one the indicators of the questions posed by descriptive-analysis.

First, the indicator to be analyzed is student interest in online learning. From the results of the data obtained, it is known that 83% of students stated that online learning was not fun, even most felt that online learning was very unpleasant. This shows the low interest of students in the implementation of online learning. the results of this study were supported who obtained the results of student responses in online learning being less fun, because of the many obstacles and problems encountered in its implementation. In line with the results research which states that students' motivation in learning is reduced by the online learning system. However, unlike the research conducted, the results of his research actually show that there is an increase in student interest and motivation in online learning, and the level of student satisfaction in online learning also increases. The difference in the results of this study may occur due to the different characteristics of students, the different carrying capacity of the facilities, the level of teacher's ability to innovate learning strategies, and the conditions of the implementation of learning experienced by students are also different.

Second, the indicator analyzed is the level of understanding of students in online learning. The results of the data show that 84% of students are unable to understand the learning material delivered by the teacher through online learning, this condition is of course concerning, because if students do not have understanding, it means that the learning objectives will not be achieved. This research is reinforced by the results which shows students' negative responses to online learning because some subject matter is difficult for students to understand. Also states that the lack of guidance from teachers makes it difficult for students to accept subject matter. explained that students find it difficult to understand subject matter with an online



system due to the variety of student learning styles, besides that internet signals also greatly affect students' ability to capture lessons.

Third, the indicators observed were students' skills in using digital media in online learning. The research data obtained that 59% of students are not able to use digital media as the main learning media in the online learning system. This is supported by the results of research which states that one of the inhibiting factors of online learning is the inability of students to use learning media used by teachers. Whereas stated that online learning is highly dependent on digital technology. Also states that the use of digital media in online learning is very flexible, it can be used anywhere and anytime states that three main factors in the success of online learning are the sophistication of appropriate technology, teachers who master digital technology, and students who have the ability to use technology appropriately. Based on the discussion above, it can be analyzed that if teachers and students do not have skills in using digital technology, then online learning cannot run effectively.

Fourth, the observed indicator is the comfort of students in learning. From the results of the study, it was found that 82% of students did not feel comfortable studying at home. This is in line with research conducted who found problems when studying at home, such as slow networks, blackouts, difficulty asking questions, and an unfavorable home atmosphere. Whereas stated that in the implementation of online learning, students, teachers, and parents have a very important role in learning activities. Teachers also have an additional role in providing emotional support for students, parents, and families, as well as being able to establish good cooperation with parents/families according to. Stated that the positive impact of online learning is that children have a lot of time with their families, and some children should feel more comfortable studying at home. From the discussion above, it was found that the problem is that children or students do not feel comfortable studying at home, this is of course many factors that influence it as stated.

Fifth, indicators of the workload received by students. Based on the survey results, it was found that 75% of students felt that the tasks given by the teacher were very burdensome. The number of assignments given to students actually has no effect on increasing student achievement or learning outcomes. Conducted a study comparing student achievement during the pandemic with before the pandemic, and he found that there was a decline in student achievement during the pandemic. States that the problems faced in

online learning, one of which is the number of tasks that teachers assign to students. Also states that the tasks given are generally independent tasks and not group assignments, so students cannot actively interact with students friends, and this causes less effective learning.

In an effort to strengthen the validity of the data, the researchers extended the research time, and based on the results of observations and interviews it was found that the problems that arise in the implementation of online learning at Muhammadiyah 47 Junior High School, are: 1) there are still many students who do not have gadgets; 2) the limited use of learning media, only in the form of chat and voicenotes, so that they cannot replace the presence of the teacher; 3) the increasing need for internet quota, which is directly proportional to the increase in the budget for learning; 4) the emergence of boredom of parents on the behavior of children who are more often struggling with cellphones than to interact and communicate with people in the surrounding environment; 5) the emotional readiness of students in receiving lessons is not recorded; 6) the tasks given by the teacher are rarely done by children, this can happen because students do not understand in understanding the questions and subject matter; 7) the learning process is not optimal, because everything is limited, and 8) decreasing level of student discipline and student learning outcomes.

## **Conclusion**

Based on the results of research and discussion, it can be concluded that the online learning system in the perceptions of students of Muhammadiyah 47 Junior High School, gives negative results. Of the five observation indicators, all of them show a high percentage of the ineffectiveness of the online learning process. The findings of this study can certainly be input for the government and educational institutions in determining more appropriate education system policies. And for teachers, they are also more innovative in finding learning strategies that can increase students' interest and motivation in learning, both offline and online.

## **References**

- [1] I. Kamil, "Kilas Balik Pembelajaran Jarak Jauh akibat Pandemi Covid-19," *Kompas.com*, 2020.
- [2] A. Adit, "5 Langkah Susun Strategi Pendidikan di Masa Depan Pasca Pandemi," *Kompas. Com*, 2020.

- [3] F. Rahadi, "Pembelajaran Daring Harus Dilakukan Secara Menyenangkan," *Republika.co.id*, Jakarta, 2021.
- [4] A. S. Syafitri, "Pendidikan Daring di Masa Covid-19," *Kompas.Com*, 2020.
- [5] N. F. Shalihah, "4 Hal yang Beda Saat Belajar Tatap Muka di Sekolah pada Masa Pandemi," *Kompas.Com*, 2020.
- [6] A. Adit, "Ini Peran dan Tuntutan Kompetensi Guru di Masa Pandemi," *Kompas.Com*, 2020.
- [7] V. D. Soni, "Global Impact of E-learning during COVID 19," *SSRN Electron. J.*, 2020, doi: 10.2139/ssrn.3630073.
- [8] L. D. Wijaya and E. Kurniawati, "Dampak Negatif dan Positif Pembelajaran Jarak Jauh Selama Pandemi Covid-19," *Tempo.co*, Jakarta, 2020.
- [9] D. Andriani, K. H. Prasetyo, and E. L. Astutiningtyas, "Respon Siswa Terhadap Pembelajaran Dalam Jaringan (Daring) Pada Mata Pelajaran Matematika," *Absis Math. Educ. J.*, vol. 2, no. 1, p. 24, 2020, doi: 10.32585/absis.v2i1.830.
- [10] S. Sujarwo, S. Sukmawati, A. Akhiruddin, R. Ridwan, and S. S. Suharti Siradjuddin, "An Analysis of University Students' Perspective On Online Learning in The Midst of Covid-19 Pandemic," *J. Pendidik. dan Pengajaran*, vol. 53, no. 2, pp. 125–137, 2020, doi: 10.23887/jpp.v53i2.24964.
- [11] R. Husaini, "Student's response in online learning process: A case study of English Education students," *JETLe (Journal English Lang. Teach. Learn.)*, vol. 2, no. 1, pp. 16–22, 2020, doi: 10.18860/jetle.v2i1.10127.
- [12] M. Rompas, "Respon Siswa terhadap Belajar dari Rumah pada Masa Corona Virus Melalui Pembelajaran Jarak Jauh dalam Jaringan," *J. Kreat. Online*, vol. 9, no. 1, pp. 32–43, 2021.
- [13] Purniawan and W. Sumarni, "Analisis Respon Siswa Pada Pembelajaran Daring di Masa Pandemi Covid 19," in *Seminar Nasional Pascasarjana UNNES*, 2020, pp. 784–789.
- [14] H. N. Arifin, "Respon Siswa Terhadap Pembelajaran Dalam Jaringan Masa Pandemi Covid-19 Di Madrasah Aliyah Al-Amin Tabanan," *J. Pendidik. Ekon.*, vol. 5, no. 9, 2020.
- [15] I. Yuzulia, "The Challenges of Online Learning during Pandemic: Students' Voice," *Wanastra J. Bhs. dan Sastra*, vol. 13, no. 1, pp. 08–12, 2021, doi: 10.31294/w.v13i1.9759.
- [16] R. Hamid, I. Sentryo, and S. Hasan, "Online learning and its problems in the Covid-19 emergency period," *J. Prima Edukasia*, vol. 8, no. 1, pp. 86–95, 2020, doi: 10.21831/jpe.v8i1.32165.

- [17] Nuryana and M. F. Munsir, "AKTUALISASI DISTANCE LEARNING PADA MASA PANDEMI COVID-19 DI JENJANG PENDIDIKAN DASAR DAN MENENGAH A . PENDAHULUAN Isu pandemi Covid 19 hingga hari ini masih menjadi catatan dan perhatian penting bagi semua pihak . Pandemi menarik untuk dicermati bukan saja," *Edueksos*, vol. X, no. 1, pp. 149–169, 2021.
- [18] Y. B. Hermanto and V. A. Srimulyani, "The Challenges of Online Learning During The Covid-19 Pandemic," *J. Pendidik. dan Pengajaran*, vol. 54, no. 1, pp. 46–57, 2021, doi: 10.31294/w.v13i1.9759.
- [19] M. D. Dascalu *et al.*, "Before and during COVID-19: A Cohesion Network Analysis of students' online participation in moodle courses," *Comput. Human Behav.*, vol. 121, Aug. 2021, doi: 10.1016/j.chb.2021.106780.
- [20] M. Syafi'i, W. R. A. Wiranti, and Yusnawati, "Respon Siswa Dalam Pembelajaran Online Selama Pandemi Covid-19 Di SMP Negeri 1 Dumai," *Riau Educ. J.*, vol. 1, no. 1, pp. 27–31, 2021.
- [21] Z. Jamaludin, S. Syaharuddin, A. Ahmad, N. I. Sari, V. Mandailina, and D. Pramita, "Analysis of Students Responses To Online Learning Using Unified Theory of Acceptance and Use of Technology Model," *Paedagogia J. Kajian, Penelit. dan Pengemb. Kependidikan*, vol. 12, no. 1, pp. 75–82, 2021.
- [22] P. C. Sun, R. J. Tsai, G. Finger, Y. Y. Chen, and D. Yeh, "What drives a successful e-Learning? An empirical investigation of the critical factors influencing learner satisfaction," *Comput. Educ.*, vol. 50, no. 4, pp. 1183–1202, May 2008, doi: 10.1016/j.compedu.2006.11.007.
- [23] T. Volery and D. Lord, "Critical success factors in online education," *Int. J. Educ. Manag.*, vol. 14, no. 5, pp. 216–223, Sep. 2000, doi: 10.1108/09513540010344731.

# Indonesia In Society 5.0 ; Impact On Legal Policy

Rizka <sup>96</sup>

## Introduction

The Society 5.0 concept aims to solve social problems from a new perspective. In this new era, various aspects will be connected and technology will join the intelligent society with full integration of big data, Internet of Things (IoT), Artificial Intelligence (AI), and people services to help digital and physical infrastructure for humans. The goal is to provide a social basis on which to build: anyone can develop values, anytime and anywhere, in a safe environment and in accordance with the natural environment, without the limitations that exist today [1].

With the globalization of the economy and knowledge, and the widespread integration of new technologies driving modern economies, lifestyles, and cultures, today's society must face and adapt to these changes to prepare for the increased automation of technology and the integration of new technologies throughout society, individuals must be trained for fluency in new information technologies and be prepared to deal with concerns and problems that will arise [2].

Industry 4.0 which is based on cyber physical has made drastic changes, both in terms of economic, social, political, and even individual behaviour. The Covid-19 pandemic that hit globally, has made all the world's population turn to telecommunications and digital technology. The necessity of social distancing and transactions without meeting physically have almost doubled the use and spending of telecommunication quotas. You can count this doubled increase, the multiplier impact of its effect on the digital economy.

Indonesia is one of the countries that will face industry 4.0 and society 5.0. With the rapid development of technology, it is hoped that the Indonesian people can carry out their activities more effectively and efficiently. The Indonesian government in dealing with industry 4.0 and society 5.0 experienced several obstacles in their application. This can be seen from the legal aspect which is unable to keep up with current technological developments, so that people do not have limitations in using the technology. If the Indonesian government does not immediately make legal products related to

---

<sup>96</sup> Universitas Muhammadiyah Surakarta

policies about industry 4.0 and society 5.0, it is feared that there will be no legal protection for the community because of industry 4.0 and society 5.0. For example, with the development of technology, a company becomes motivated to make a policy of adding sophisticated machines to replace human resources. This will result in significant unemployment growth.

Entering Industry 5.0 with the characteristics of super speed telecommunications, the law will not be separated from its impact. Various legal professions in government, such as regulatory and legislative processes, cannot work conservatively without a digital approach. Likewise, the process of drafting regulations, which so far, often requires lengthy legal, political, and bureaucratic processes and tends to prioritize procedures and sectoral egos rather than substance, must be reorganized.

The progressive steps of the government and parliament, such as the omnibus law model of legislation, in the field of digital transformation, real instances can be found, particularly in the fields of postal telecommunications and broadcasting, are real examples. Many things that have been delayed for a dozen years are hampered by regulations, so that digital transformation is hampered such as the use of sharing infrastructure, digital dividend frequency spectrum, making the telecommunications industry able to compete with over the top as carriers of modern technology.

## **Discussion**

### **About Society 5.0**

Five strategic fields were selected as being able to use Japan's strengths and appeal to

the world: Extension of healthy lifespan, Realization of mobility revolution, Creation of next generation supply chains, Building and development of pleasant infrastructure and towns, and FinTech. Taking "extension of a healthy life span" as an example, Japan is one of the first countries in the world to move toward an aging society, but it also has a wealth of data thanks to a universal healthcare system and a nursing care insurance system. As a result, the construction of a "new system of health" will be accomplished through medical treatment, nursing care, and self-support, with an emphasis on health management, sickness prevention, and self-support. Important cross-cutting themes like human resource development and value generation through digitalization promotion have already been incorporated into specific actions.[3].

Recognizing that the world is becoming increasingly interconnected beyond traditional borders at a rate we have never seen before, and that the world is evolving at a breakneck pace fuelled by digital transformation, the executive members have demonstrated "preparedness" for this unpredictable and unforeseeable near future as the most fundamental challenge to be addressed throughout the Fifth Basic Plan. It will be vital to invest in people and provide space for them to test their ideas if future industry and society are to be created. What we're seeing here is a shift away from traditional technology-driven innovation policies and toward a more societally focused and problem-driven approach. The framework of the Fifth Basic Plan can be divided into four categories: 2. Dealing with socioeconomic and geopolitical challenges 1. Educating the next generation: Industry and Society in the Future 3. Investing on "fundamentals" like people and greatness. 4. More effective STI systems.[4].

Society 5.0 is a concept of community technology that is human-centred and collaborates with technology (AI and IoT) to solve social problems that are integrated in virtual and real-world spaces. Prior to Society 5.0, there were earlier versions, namely Society 1.0 (Hunting Society), Society 2.0 (Farming Society), Society 3.0 (Industrial Society) and Society 4.0 (Information Society). So, Society 5.0 is a new era in social life that has been integrated with technological systems in the form of IoT (Internet of Things) and AI (Artificial Intelligence) that can process big data and analyse that data. Technology integration with society will be important as it is relevant to use drone delivery, artificial intelligence, big data, autonomous trucks, and robotics soon for the benefit of humankind [5].

Society 5.0 reaches a high level of convergence between cyberspace and real space, allowing AI based on big data and robots to perform or assist as work agents and adjusts that humans have created to date. It liberates people from mundane daily duties and jobs at which they are not very skilled, and through the creation of new value, it enables the provision of only the products and services that are needed by the people who need them in their time of need, thereby perfecting the entire social system and organization. However, not everything is easy, and it is important to be aware of the worrying behaviour caused by all the situations described, such as the so-called "cyberchondria" and "digital syndrome," which need to be carefully analysed and prevented today [6].

People in the Era of Society 5.0 live in an order that is in line with the idea of globalization and the elimination of waste in its various mobility. People in the Era of Society 5.0 indeed live in an integrated manner with technology. Therefore, the people of that era had an ordering system in one data that was connected to all the software that supported their activities [7].

### **Legal Handling Policy**

The law is limping in the face of that reality as a postulate which says that “the law has been flawed since its emergence.” This further emphasizes that, no matter how futuristic the law is, in the end, the law will be far and difficult to follow a reality. For this reason, the law is not something that is final and has been completed (“finitive scheme”), but something that continues to move and change in its efforts to serve and make people happy [8].

The challenge facing 5.0 is the need to reform law enforcement in order to achieve the rule of law that is just. Forms of law enforcement reform that can be carried out, are first, the use of a just law as the basis for good decision making by state apparatus. Second, Suhartoyo continued, court institutions must be able to keep independence, impartiality, and freedom in deciding cases. Third, increasing the professionalism of law enforcement officers. Fourth, law enforcement is increasingly based on the principles of justice. Fifth, the promotion and protection of human rights. Sixth, public participation and effective oversight mechanisms.

In the field of government, legal rules that are burdensome and can result in too excessive costs must adapt to the development of the industrial revolution 4.0 or 5.0 so that justice seekers can feel the substantive changes of these rules. Such as the efforts of the Judicial Commission (KY) in realizing access to justice. The role of Judicial Commission is to try to oversee the justice process so that the judiciary runs in a transparent, accountable, and impartial manner.

The practice of “The Japanese Twist” deserves to be a lesson for the Indonesian people in various fields, especially in the field of law. In the field of law, even though Indonesia has begun to discourse on laws that are unique and in accordance with the personality of the nation, Indonesian law cannot be separated from the existence of western domination, in this case the Netherlands. Apart from still being dominated by the concept of “civil law” and the principle of concordance, Indonesian law is also seen as too normative and



formalistic. Such laws tend to be rigid, inflexible, and difficult to integrate with the development of society. Therefore, in the face of the 4.0 industrial revolution, the Indonesian nation's legal system should follow the Society 5.0 mindset. by prioritizing "local minded" even in the face of international and universal problems. That way, the way of law in Indonesia must be "The Indonesian Twist" as has been carried out in Japan in welcoming Society 5.0 [8].

### **Brand Protection**

The brand is one of the intellectual properties that can be extended. Brands that are registered and whose protection period has expired, which is ten years, can still be extended for another ten years and so on. If the computer program product is added with a brand and the brand period can be extended and extended, the brand has indirectly protected the computer program even longer. People will be fanatical about the product by always remembering the brand.

The copyrighted work will be transformed as a means of guaranteeing product quality so that the quality of the copyrighted product can be guaranteed. Copyright can be transformed as information on the origin of the product by the brand so that the public is increasingly protected and it is clear where to address the request for accountability. The strengthening of brands for copyright protection is an example of intellectual property protection with multiple regimes, namely the copyright legal regime and the brand legal regime. Creative and innovative works in the 4.0 technology phase will be strengthened by brands, either product brands, service brands or collective brands. The creative work of society 5.0 in the industrial 4.0 phase needs to get multi-regime legal protection, so that between one legal regime and another legal regime does not overlap and there is a function of legal certainty [9].

### **Copyright Protection**

Intellectual Property is the official translation of Intellectual Property Rights (IPRs). Based on its substance, IPR is closely related to intangible objects and protects intellectual works born of human creativity, taste, and work. IPR is a product of the creation and innovation of the human ratio. Agus Sardjono argues that IPR is a right that cannot be separated from economic problems. According to Indonesia Dictionary, commercialization is the act of making something into merchandise. Commercialization is a series of efforts from the development and marketing of a product or process and the

application of the process in production activities. Production activities aim to increase more value. There is more value from an intellectual property product and economic rights are attached to the owner [9].

### **Data Protection**

Two legal challenges with the 5.0 era are first, aspects of the protection and management of personal data; and the second is the legal aspect of artificial intelligence or AI.

First, the protection and management of personal data, data has two legal aspects, namely the protection aspect and the management aspect. The protection aspect focuses on preventing the parties from spreading and using other than transaction interests. On the other hand, personal data management in this case focuses on managing databases to support business activities without harming the owner of personal data, for example the risk of data being hacked.

If the threat of data hacking cannot be predicted, it will result in business interruption and will cause a victim multiplier, namely the increase in victims because the initial crime (in this case the initial data hack) did not be expected. Currently, Indonesia only has Ministerial Regulation Number 20 of 2016 concerning the protection of personal data. This policy has many main weaknesses to support an artificial intelligence-based business ecosystem. The urgency of welcoming the society-based 5.0 era must encourage the government to immediately ratify the personal data protection bill (RUU PDP). In addition, in recent days, reports about 279 million Indonesian population data have been hacked.

The second challenge is that the AI aspect is still experiencing legal gaps. Legal rules related to AI should have been prepared when entering the 4.0 era. But the fact is that so far there is none. Regarding the protection of personal data, Indonesia does not yet have specific rules about the protection of personal data at the legal level. However, based on research conducted by the Institute for Community Studies and Advocacy (ELSAM) there are at least 30 (thirty) statutory provisions governing the obligation to provide personal data protection in Indonesia.

Although the Constitution of electronic information and transaction (UU ITE) regulates personal data, the Constitution of electronic information and transaction does not provide a definition of personal data itself. [10]

Legal protection for misuse of personal data can be done through self-regulation or prevention efforts if the current regulations do not cover the system for misuse of personal data. Therefore, the bill on the protection of personal data must be ratified at once, considering that many other countries have regulated the protection of personal data. Those who are directly affected by the processing of personal data can ask the Board of Commissioners to evaluate the process to decide if it meets the provisions of the Data Protection Act 1998 [11].

In cross-related obligations, the Ministry of Communications and Information Technology has initiated legal action with the legal apparatus, namely the police by carrying out educational activities related to the prevention of special internet fraud practices that intersect with privacy law protection for personal data security, including the following: 1. Increase awareness of information security to the public and law enforcement officers. 2. Improving the knowledge and capability of law enforcement officers (Police, Prosecutors and Judges) regarding trends in cyber-crime and law enforcement, both legal and technical digital forensics, so as not to act illegally in the laws that exist in society; 3. Develop the required and necessary regulations, namely personal data, eligibility certification, reliability certification, and electronic signature; 4. Encouraging e-commerce operators to register their electronic systems with the intention of being known by the public as trusted providers; 5. Conduct an information security index assessment for government agencies or institutions so that these agencies understand the condition of their information security and can take the necessary efforts to improve information security. [12]

### **Impact of Society 5.0 On E-Commerce**

Products transacted in e-commerce will be more diverse. The industrial era 4.0 will bring out many new products in various fields, then in the era of society 5.0, people's lives are already based on digital technology and online transactions, so that e-commerce will automatically transact various products to meet the needs of the community online. The growth of start-up companies will increase significantly. Because the industrial era 4.0 and society 5.0 will bring up diverse products and higher business transactions, then the need for products is also getting higher, companies will automatically appear to fulfil all of this, especially start-up companies. With the establishment of these companies, it will create job opportunities.

Business competition will become tougher. As increased companies appear, the competition will be tougher, especially for companies that have the same business processes, marketplace, and marketing targets. Producers, consumers, and distributors will increase. When products are increasingly diverse and the need for products automatically increases the number of producers, consumers and distributors is increasing. Public policies and regulations will get better. The government as a policy and regulation maker will always make, review, and improve policies and regulations so that the policies and regulations issued are getting better and helping all parties. Marketing and advertising will grow and be more creative because the industrial era 4.0 and society 5.0 are an era of digital transformation that will help product marketing and advertising so that they grow and be more creative and will attract consumer interest.

E-commerce support services will get better and more complex. The use of IoT technology, big data, cloud, AI, and other technologies in industry 4.0 and society 5.0, will provide added value for e-commerce support services so that they are better, more sophisticated, and more complex. Business partnerships will be wide open. The use of the internet will direct access to cross borders between countries, so that opportunities for business partnerships will be wide open, not limited to one country but can reach the international community. E-commerce technology will get better, renewable, and more sophisticated. Because e-commerce will follow and adapt its technology to technological developments in the industrial era 4.0 and society 5.0, in that era technology will always develop according to the needs of industry and society. [13]

## **Conclusion**

Advances in technological development have impacts and benefits; establishing Society 5.0 with technological attributes will allow Japan, as well as the rest of the globe, to achieve economic progress while addressing important social issues. Including in Indonesia in terms of legal policies, of course, must prepare with a pattern of society 5.0. For handling legal policies, it is also necessary to reform law enforcement in order to achieve the rule of the fair law. The role of law is especially important in regulating the balance between technological developments and human resources. In addition, not all levels of society in Indonesia understand the technology that is currently developing. People who do not have

access to current technological developments will certainly have difficulty in dealing with industry 4.0 and society 5.0. Therefore, Indonesian government needs to carry out equal distribution of education that prioritizes the application of industry 4.0 and society 5.0 so that people start being educated from elementary school to university levels in following technological developments.

## References

- [1] C. Narvaez Rojas, G. A. Alomia Peñafiel, D. F. Loaiza Buitrago, and C. A. Tavera Romero, "Society 5.0: A Japanese concept for a superintelligent society," *Sustain.*, vol. 13, no. 12, 2021, doi: 10.3390/su13126567.
- [2] A. Yamada, "Japanese Higher Education," *J. Comp. Int. High. Educ.*, vol. 13, no. 1, pp. 44–65, 2021, doi: 10.32674/jcihe.v13i1.1980.
- [3] M. Fukuyama, "Society 5.0: Aiming for a New Human-centered Society," *Japan Spotlight*, no. August, pp. 8–13, 2018.
- [4] Y. Harayama, "Panorama Digital Asia," pp. 33–45, 2016.
- [5] A. G. Pereira, T. M. Lima, and F. Charrua-santos, "Industry 4.0 and Society 5.0: Opportunities and Threats," *Int. J. Recent Technol. Eng.*, vol. 8, no. 5, pp. 3305–3308, 2020, doi: 10.35940/ijrte.d8764.018520.
- [6] M. J. Sá, A. I. Santos, S. Serpa, and C. M. Ferreira, "Digital Literacy in Digital Society 5.0: Some Challenges," *Acad. J. Interdiscip. Stud.*, vol. 10, no. 2, pp. 1–9, 2021, doi: 10.36941/ajis-2021-0033.
- [7] M. Rahmawati, A. Ruslan, and D. Bandarsyah, "The Era of Society 5.0 as The Unification of Humans and Technology: A literature review on materialism and existentialism," *J. Sociol. Dialekt.*, vol. 16, no. 2, p. 151, 2021, doi: 10.20473/jsd.v16i2.2021.151-162.
- [8] D. E. Prasetyo and U. N. Surabaya, "Bifurkasi Hukum di Indonesia dalam Menapaki Revolusi Industri 4.0 dan Society," no. April, pp. 0–10, 2020.
- [9] Surdaryat, D. E. Sukarsa, and A. M. Ramli, "Perlindungan Kekayaan Intelektual Karya Kreatif Dan Inovatif Bisnis Startup di Indonesia," *Acta Diurnal J. Huk. Kenotariatan*, vol. 4, no. 1, pp. 68–82, 2020.
- [10] S. Yuniarti, "Perlindungan Hukum Data Pribadi Di Indonesia," *Bus. Econ. Commun. Soc. Sci. J.*, vol. 1, no. 1, pp. 147–154, 2019, doi: 10.21512/becossjournal.v1i1.6030.
- [11] S. M. T. Situmeang, "Penyalahgunaan Data Pribadi Sebagai Bentuk Kejahatan Sempurna Dalam Perspektif Hukum Siber," *Sasi*, vol. 27, no. 1, p. 38, 2021, doi: 10.47268/sasi.v27i1.394.

- [12] S. A. Astuti, "Era disrupsi teknologi 4.0 dan aspek hukum perlindungan data hak pribadi," *PAJOUL (Pakuan Justice J. Law)*, vol. 01, no. 01, pp. 1-32, 2020, [Online]. Available: <https://journal.unpak.ac.id/index.php/pajoul/index>.
- [13] D. Hendarsyah, "E-Commerce Di Era Industri 4.0 Dan Society 5.0," *IQTISHADUNA J. Ilm. Ekon. Kita*, vol. 8, no. 2, pp. 171-184, 2019, doi: 10.46367/iqtishaduna.v8i2.170.

# **The Implementation of the Teaching and Learning Model of the Value Clarification Technique in Society Era 5.0**

Ronggo Warsito<sup>97</sup>, Dhiva Maulida Rizqi Nur'Aini<sup>98</sup>

## **Introduction**

Pancasila education is a form of value education that fosters confidence in humans. This belief includes what is good and not good, appropriate and inappropriate. The value system basically exists in a person's heart that will determine his behavior and actions. Value education aims so that a person can distinguish between good and bad through reasoning and beliefs. Relevant to this, the goal of Pancasila Education is the development of attitudes, morals, and beliefs to act in accordance with the values of Pancasila. Pancasila education will be achieved well if the approach is in the form of activities that provide a stimulus. It also invites and makes it easier for students to learn. Learning Pancasila Education uses a variety of learning resources. With a variety of learning resources, it is possible for teachers and students to critically and creatively. This is relevant to what was stated by Sari [1]. The target of teaching and learning requires certain methods. The method that suits these goals is the Value Clarification Technique.

Value Clarification Technique is one of the strategies to develop affective aspects. This is very suitable to be applied in the era of society 5.0 which seeks to restore the importance of human values, social values, and so on. Value Clarification Technique is a teaching and learning technique that fosters attitudes or values and morals. The VCT is very much in line with the Civics Education field of study which prioritizes the development of affective aspects. This does not mean that VCT cannot be used to develop other aspects. VCT can be used to foster and develop the three aspects, namely cognitive, affective, and psychomotor. However, the main goal of the VCT strategy is to develop the affective aspect. This statement is relevant to that conveyed by Maulana, Mahfud, and Adi [2] and relevant to Arif, Riza, and Pambudi [3]. The VCT teaching is effective for developing

---

<sup>97</sup>Universitas Widya Dharma Klaten, [warsito.unwidha@gmail.com](mailto:warsito.unwidha@gmail.com)

<sup>98</sup>Universitas Sebelas Maret Surakarta, [dhivamaulida13@student.uns.ac.id](mailto:dhivamaulida13@student.uns.ac.id)

affective aspects and is also suitable for developing cognitive and psychomotor aspects. If value clarification is used as a teaching method, then VCT is a teaching technique to instill, explore, or express certain values.

Morals must be taught by involving students in active and real activities. Morals are developed through social interaction and the use of reasoning, so that they actively discover positive moral concepts or principles. The VCT strategy begins with some dubious conflicts or problems. Students are involved in investigating problems, discussing problems in small group discussions and then summarizing and formulating their views. The Value Clarification Technique targets the cultivation and development of a value. This is done in order to achieve a critical, rational and objective and humane development process (appreciating human potential). This is very much in line with the aspirations of the 5.0 community [4] The VCT also involves affective aspects, namely emotions, feelings, and others from students. This condition includes an atmosphere that is familiar, warm, open, and free from any coercion.

The VCT tries to eliminate verbalism, coercion, and rape of human potential such as indoctrination. The VCT wants to preserve and personalize a value in oneself and behavior. If the Value Clarification Technique is used as a method in Pancasila Education, then the VCT seeks to direct that goal. The intended direction is a change in attitudes and behavior according to the guidance of Pancasila values. This is because Pancasila is not merely to be understood, but more than that to be lived and practiced. This statement is relevant to that conveyed by Separsa, Lasmawan, and Suarni [5] according to him that learning Pancasila education is not only to be memorized but more importantly to be lived and practiced in daily behavior. In this way, the learning outcomes are more imprinted because they are contextual. One of the ways to learn Pancasila education is to use the value clarification technique strategy [6]

Through the VCT there are many things that can be expected. Students can learn to make positive choices when faced with difficult ethical and moral problems. Students can see the alternatives. Students can consider alternatives and consequences seriously. Teachers and students are able to strengthen their choices. Educators can treat and live the student's choices. With the VCT the students can directly test ways of behaving in their lives. The expert gave a slightly different opinion regarding the purpose of the VCT. Purpose of the



Value Clarification Method is quite diverse [7]. The VCT is able to explore the level of quantity and quality of a person regarding a value. The VCT method can foster a person's awareness of a value. The VCT can help direct and renew one's values through new values. The VCT trains a person in how to assess, examine a value, or make decisions about a value.

## **Discussion**

This study resulted in a teaching and learning strategy with the Value Clarification Technique (VCT) pattern. The strategy in question is described as follows. Starting with a topic or subject, it is packaged in a comprehensive program called the Complete Program. This Complete Program is comprehensive. The complete program includes General Lecture Objectives and Lecture Specific Objectives. In addition, it also contains subject matter, method choices, media choices, and evaluation points. A complete program consisting of six elements is used as a basis for finding or determining target values. Target values include (1) stimulus, (2) story, (3) example, (4) picture or photo, and others. The complete program is implemented in the teaching and learning process. In the teaching and learning process with the application of this the VCT, efforts are made to create a humane learning atmosphere. Human learning means learning that is warm, open, familiar, full of motivation, and is free and objective. Besides being human, it also needs a conditioning learning atmosphere [8]

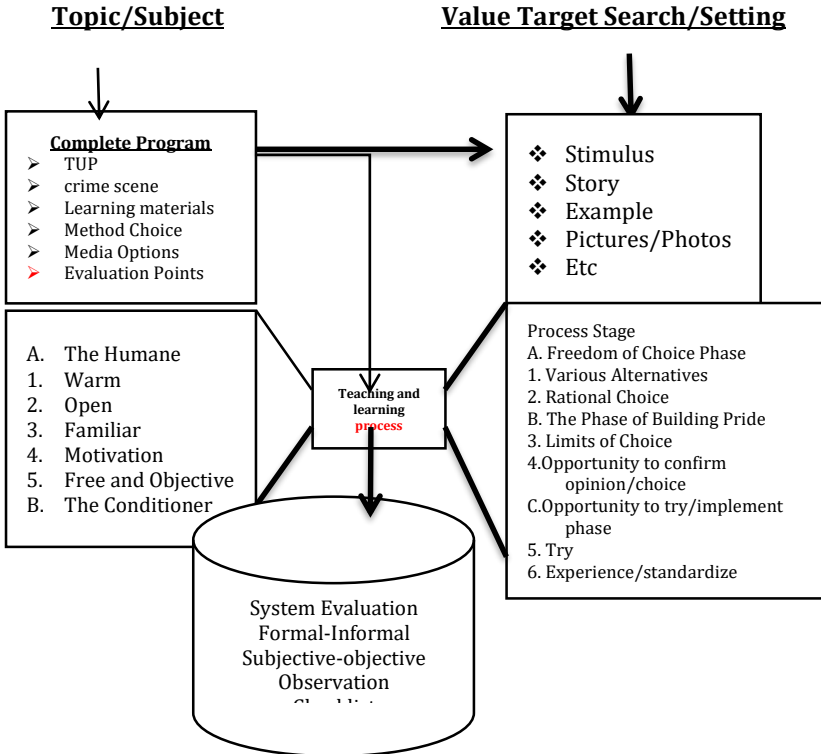
The teaching and learning process with the implementation of the VCT is carried out in three stages of the process. The three stages of the process in question are (1) the phase of freedom of choice, (2) the phase of building pride, and (3) the phase of trying/implementing the opportunity. The phase of freedom of choice includes two things, namely the diversity of alternatives and various rational choices. The phase of building pride includes two things, namely the limit of his choice and the opportunity to confirm his opinion/choice. The opportunity phase of trying/implementing also includes two things, namely trying and experiencing/standardizing. The teaching and learning process that has been going well, needs to be evaluated [9]. The purpose of this evaluation activity is to determine the supporting and inhibiting factors in the teaching and learning process. Evaluation activities are also intended to determine the extent to which the teaching and learning process has been in accordance with what was programmed. In addition, the evaluation

also aims to determine the extent to which students have reached the Minimum Completeness Criteria [10]

Evaluation activities are used to evaluate the system as a whole [11]. Evaluation activities are carried out both formally and informally. The evaluation technique uses test and non-test techniques. The tests used are in the form of subjective tests and objective tests. Subjective tests are in the form of essays or descriptions and objective tests are in the form of multiple choice. This test is very important to carry out. By doing a test, it can be seen the success of a lesson and find out the shortcomings that exist [12]. Evaluation is not only done by using a test technique, but also by using a non-test technique. The non-test technique used is the observation and checklist technique. Observation is to know of an object. By observing, the description of an object can be known. Observation is also useful to cover the deficiencies that exist in the test. The observation technique will be able to perfect the shortcomings of the test technique [13]. Checklist is one of the informal methods of observation that has determined indicators. Checklists are used to describe psychomotor, social, and cognitive development [14]. Checklist is a non-test strategy that is also useful to cover weaknesses in the test technique. Students usually enjoy working on this checklist because they don't have to think hard. Students or respondents can fill out the checklist according to the conditions that exist in each student.

The general chart of teaching and learning strategies with a VCT pattern is presented below.

## GENERAL CHART OF VCT PATTERN TEACHING LEARNING STRATEGIES



An example of the value clarification technique model by posing a controversial issue that contains conflict is presented below. Here, students are taught to dialogue both internally (himself) and externally (with friends). The purpose of the VCT here is to foster sharpness of senses/emotions for a case that is very decisive or important. The VCT is also a means of training skills to determine a decision. The VCT trains to work together, express opinions, accept the opinions of others, submit arguments, and make decisions. The story material that can explain this study can be described as follows. This value clarification technique will be able to bring out the emotions or feelings of students. In addition, how to direct these emotions in a good and useful direction.

### **Between Hope and Anxiety**

There is a husband and wife (A and B) who have three sons, all male. The three sons were eleven, nine, and seven years old, respectively. Suddenly A and B want to have another child, but it's a girl. Not long after, the wife was pregnant or three months pregnant and according to an obstetrician's statement, the baby had an abnormality. Upon this information, the husband and wife became anxious and wanted to abort. But after being examined by another obstetrician, the doctor stated that the baby was normal and male. A and B became anxious and confused because another boy was about to be born. In the end, the husband and wife decided to abort the baby.

Task:

How do you respond to A and B's decision to abort the baby?

1. What would you do if you were A?
2. What would you do if you were B?
3. How would you feel if you were the prospective baby to be aborted?

Task: An example of the second case is presented as follows. Rendi, single, handsome, final year student of a college in Jakarta. Apart from being a final student, he is also the head of the credit bureau at a large bank in Jakarta. He loves a beautiful girl, Melati who is also a staff member of the bank, who is the head of the finance bureau. They love and love each other and agreed to marry in the near future. The invitations have been printed and they have prepared everything. Next comes the regulation, that in a work unit and or the same office it is forbidden to have employees who have a sibling relationship and or husband and wife. If that happens, one must either move or quit. Rendi found it hard to quit because he was working to pay for his college education, which was almost finished and the costs of his sister and mother who were sick and widowed. Likewise Melati, she started her career as a lowly employee and worked for her three younger siblings who were still small and orphaned.

Find pairs in groups of three boys (students) and three girls (students). The male plays the role of Rendi and the female as Melati. Review the case above and discuss it carefully. Fill in the following form as your activity report!

Activity Sheet Format:

Main problems faced:

.....  
.....

.....  
The dilemma we face:  
.....  
.....  
.....

Decisions taken:

1. 1st pair : .....
2. 2nd pair : .....
3. 3rd pair : .....

Group decision options:  
.....

Reason for Decision:  
.....

The steps in TKN after preparing a complete program are four stages. The four stages are (1) determining the stimulus, (2) presenting the stimulus, (3) determining the position, and (4) testing the reason. The first step, determining the stimulus involves a value dilemma. The second step presents the stimulus by raising the problem, identifying facts, determining common understanding, and determining the center of the problem to be clarified. The third step is determining the position which includes the activities of determining individual/individual positioning, determining the position of groups/classes, and clarifying the choice of position (reason for choice). The fourth step, testing the reasons includes two activities, namely testing the reasons with various arguments and strengthening the arguments. The termination strategy in question is (1) conclusion and direction (2) follow-up. Conclusions and directions include recapitulation/conclusion activities, comments, and final/closing activities. Follow-up in the form of remedial/enrichment activities, and extra activities outside the classroom either individually or in groups.

There are several processes or steps for taking value through value clarification techniques. States that teaching a value requires three important steps. The three steps in question. First, the teacher must provide opportunities for students to express their ideas, feelings or experiences related to the topic of the problem. Second, the statement or expression of values related to the topic of the problem must be accepted by not imposing a direct decision. Third, students should be encouraged to test their position on a specific problem and also explore other aspects of the problem.

## Conclusion

The Value Clarification Technique is a teaching and learning strategy that fosters attitudes, values, and morals. The VCT is one of the strategies to develop the affective aspect so that it is very suitable for the field of Civics. This does not mean that the VCT cannot be used to develop other aspects. The VCT can be used to foster and develop the three aspects, namely cognitive, affective, and psychomotor. However, the main goal of the VCT strategy is to develop the affective aspect. The VCT strategy begins with some dubious conflicts or problems. In TKN, students are actively involved in investigating problems and discussing problems and then summarizing and formulating their views. Learning with the VCT strategy also involves affective aspects, namely emotions, feelings, and others from students. In the VCT learning, an atmosphere that is familiar, warm, open, and free from any coercion is created.

The implementation of the VCT learning model strongly supports the growth and development of human attitudes. The VCT strives to be able to bring out the good nature of humans which is their nature. By nature every human being is good. It will be able to grow and develop with the VCT strategy. The VCT strategy like this is very suitable to be applied in the era of society 5.0. Society 5.0 as developed by Japanese Prime Minister Shinzo Abe seeks to restore the importance of human values, social values, and so on. Society 5.0 has the characteristics of human centered, technology based, technology dedicated to improving human capabilities. Society 5.0 aims to balance technological progress with integrated social problem solving.

## References

- [1] I. P. Sari, "IMPLEMENTASI PEMBELAJARAN BERBASIS E-LEARNING MENGGUNAKAN CLAROLINE," *Res. Dev. J. Educ.*, vol. 4, no. 1, 2017, doi: 10.30998/rdje.v4i1.2070.
- [2] S. A. Maulana, H. Mahfud, and F. P. Adi, "Peningkatan nilai karakter disiplin peserta didik kelas V sekolah dasar melalui penerapan model value clarification technique," *Didakt. Dwija Indria*, vol. 8, no. 102, 2020.
- [3] K. B. Arif, J. K. Riza, and P. R. Pambudi, "VALUE CLARIFICATION TECHNIQUE IN ENHANCING FORGIVENESS," *Abjadia*, vol. 4, no. 1, 2019, doi: 10.18860/abj.v4i1.6288.
- [4] M. Kabatiah, "Efektivitas Pengintegrasian Pendidikan Karakter di Perguruan Tinggi Melalui Teknik Klarifikasi Nilai Pada Mata

- Kuliah Pendidikan Kewarganegaraan,” *J. Kewarganegaraan*, vol. 18, no. 1, 2021, doi: 10.24114/jk.v18i1.23730.
- [5] K. S. Anom Separsa, Wayan Lasmawan, “PENGARUH IMPLEMENTASI TEKNIK KLARIFIKASI NILAI TERHADAP PRESTASI BELAJAR PKn DENGAN KOVARIABEL SIKAP MULTIKULTUR PADA SISWA KELAS VIII SMP NEGERI 1 PAYANGAN,” *e-Journal Progr. Pascasarj. Univ. Pendidik. Ganesha Progr. Stud. Penelit. dan Eval. Pendidik.*, vol. 4, 2014.
- [6] C. C. Hyun *et al.*, “Implementation of contextual teaching and learning (CTL) to improve the concept and practice of love for faith-learning integration,” *Int. J. Control Autom.*, vol. 13, no. 1, 2020.
- [7] A. Wibowo, “KEEFEKTIFAN METODE KLARIFIKASI NILAI DALAM MENINGKATKAN KARAKTER SISWA PADA MATA PELAJARAN PKN,” *JIPSINDO*, 2015, doi: 10.21831/jipsindo.v0i0.4525.
- [8] A. Admin and N. Amirudin, “PENDIDIKAN HUMANISME DALAM PERSPEKTIF ISLAM,” *TAMADDUN*, 2017, doi: 10.30587/tamaddun.v0i0.74.
- [9] I. Magdalena, H. N. Fauzi, R. Putri, and U. M. Tangerang, “Pentingnya Evaluasi Dalam Pembelajaran Dan Akibat Memanipulasinya,” *Pendidik dan Sains - stitpn*, vol. 2, 2020.
- [10] D. Mardapi, S. Hadi, and H. Retnawati, “MENENTUKAN KRITERIA KETUNTASAN MINIMAL BERBASIS PESERTA DIDIK,” *J. Penelit. dan Eval. Pendidik.*, vol. 19, no. 1, 2015, doi: 10.21831/pep.v19i1.4553.
- [11] I. L., “EVALUASI DALAM PROSES PEMBELAJARAN,” *Adaara J. Manaj. Pendidik. Islam*, vol. 9, no. 2, 2019, doi: 10.35673/ajmpi.v9i2.427.
- [12] K. Anwar, “URGENSI EVALUASI DALAM PROSES PEMBELAJARAN,” *Rausyan Fikr J. Pemikir. dan Pencerahan*, vol. 17, no. 1, 2021, doi: 10.31000/rf.v17i1.4183.
- [13] A. Syamsudin, “Pengembangan Instrumen Evaluasi Non Tes (Informal) untuk Menjaring Data Kualitatif Perkembangan Anak Usia Dini,” *J. Pendidik. Anak*, vol. 3, pp. 403–4013, 2014.
- [14] R. : Selviani, Dewi ; Tanjung, “Pengembangan Ceklis Observasi dalam mata pelajaran Bahasa Inggris untuk Sekolah Dasar,” *Competitive*, vol. 11, 2016.

# Telepsychology: Alternative Digital Mental Health Services Towards the Society Era 5.0

Rr. Setyawati<sup>99</sup>

## Introduction

The rapid development of information technology has a significant impact on human lives. Because the Industrial Revolution 4.0 could merge digital technologies and the internet, the changes involved all elements of human existence that were previously done manually. As a result of the industrial revolution 4.0, the concept of Society 5.0 was born. Society 5.0 is a technology-based concept of a human-centered and technology-based. The existence of information technology, which is becoming more widespread and integrated in various parts of human life, has also had an impact on the field of psychology. In addition to the concepts of personal and social self, there is also a debate regarding the virtual self in the theoretical realm. Virtual space has also transformed the emerging practical arena of psychological therapies. The study of psychology must face a new potential and challenge as the world becomes increasingly connected and competitive. In the 4.0 era, providing mental health care online is both a demand and a need.

Sigmund Freud was the one who pioneered the use of technology in mental health care, providing psychotherapy through correspondence, which subsequently evolved into telephone-based psychotherapy. Furthermore, in 1972, in the United States, computers at Stanford University and UCLA were used to simulate psychotherapy sessions using the internet. Telepsychology became widely known in 1986 when Cornell University launched the "Dear Uncle Ezra" program under the direction of psychologist Jerry Feist. "Uncle Ezra" has answered more than 20,000 questions from Cornell students and advice seekers from more than 30 countries. When the World Wide Web became widely available in the early 1990s, and mental health experts began to build websites giving mental health information, some began to accept and respond to requests for personal assistance, resulting in the emergence of online counseling. Several mental health professionals, including Ivan Goldberg, MD, and John Grohol, Psy.D.,

---

<sup>99</sup> Universitas Muhammadiyah Purwokerto,  
[rrsetyawati21psiump@gmail.com](mailto:rrsetyawati21psiump@gmail.com)



began delivering online mental health assistance through support groups and free online chats between 1993 and 1995.

In Indonesia, technology-assisted mental health services are still uncommonly applied by psychologists. Some research findings suggest that mental health service providers are still technologically savvy, but that they are too rigid and find it difficult to keep up with the pace of information technology in the digital era. The COVID-19 pandemic has changed the way mental health services are delivered, particularly in Indonesia. Due to social limitations as a means of avoiding the spread of the Covid-19 virus, mental health services employing virtual media or the internet are fast expanding. Psychological services, such as online counseling or cyber counseling, were available prior to the Covid-19 pandemic. Conditions arose during the Covid-19 pandemic that required mental health service providers to master a variety of social networking applications, including zoom meeting, cloud, google meeting, google talk, line, WhatsApp, email, Facebook, and other types of applications such as through smartphones or other devices.

"Telecare," "telehealth," "tele-behavioral health," "telepsychiatry," "tele-mental health," and "telepsychology" are all phrases that are frequently used interchangeably or without definition. The American Psychological Association (APA) defines telepsychology as the provision of behavioral and/or mental health care services such as through technological resources in lieu of, or in addition to, traditional face-to-face methods, such as telephone therapy, video conferencing diagnostic interviews, the use of applications to track mood states, and email consultation.

Telehealth refers to the provision of health-care, health-education, and health-information services through remote technology. The use of telecommunications or video conferencing technology to deliver mental health services is known as tele mental health. Telepsychiatry or telepsychology are other terms for it. Although regulatory boards have used up to 19 words to refer to TBH, tele behavioral health (TBH), a term that incorporates addiction therapy more, may be chosen over tele mental health (TMH). Telepsychiatry, a subset of telemedicine, can include psychiatric examination, therapy (individual therapy, group therapy, family therapy), patient education, and medication management, among other services.

## Results

Based on journal searches, there are several research topics related to telepsychology, namely:

**Table 1. Telepsychology and Mental Disorders**

Researcher(s)	Research Methods	N (Number of Samples)	Research Results
(Varker et al., 2018)	Systematic Review, a search for scientific journals using Medline, PsycINFO and the Cochrane library published from January 2005 to July 2016.	Search results of 2266 scientific articles, 24 articles that were studied	Telepsychology has been shown to be effective in treating clients with depression, anxiety, PTSD, or adjustment disorders, as well as interventions by telephone, texting via the Internet and video conferencing.
(Bolton & Dorstyn, 2015)	Systematic review and meta-analysis of scientific articles from 1970-2014. The literature search used the	11 (eleven) studies (N:472 participants)	Internet- and video-based telepsychology has shown satisfactory results as targeted interventions for clients with PTSD.
(Dorstyn et al., 2013)	Cochrane Library, Embase, PILOT, PubMed, PsycINFO, and Web of Science databases. Systematic Review Search databases from 1970 (CINAHL, Cochrane Library, Embase, Informit, PubMed, PsycINFO,	498 adults of Asian, African-American or Spanish descent	Methodologically it has not met the criteria for convincing and significant influence of telepsychology can overcome depression, anxiety, quality of life and psychosocial support.

---

(Coughtrey & Pistrang, 2018)	Scopus and Web of Science databases, Gray literature (i.e. Google, Gray Matters, New York Academy of Medicine, MedNar, Open Grey, SumSearch 2) and two journals peer-reviewed	790 people aged 18 and over	Psychotherapy using the telephone is quite effective in reducing symptoms of depression and anxiety
(Holmes et al., 2019)	(Journal of Telemedicine and Telecare, Journal of Telemedicine and e-Health).	862 people, in average age of 34 years old	Psychotherapy using the telephone is quite effective in reducing symptoms of depression and anxiety
(Simpson et al., 2015)	A systematic review of 14 articles published over a 25-year period (January 1991–May 2016) was conducted using the PsycINFO, PubMed, and Web of Science databases.	23 people	Psychotherapy using digital technology, namely computers and telephones, can reduce symptoms of anxiety and depression.
	Systematic Review using Cochrane Library, Embase, Pubmed, PsycINFO and Scopus databases		Video psychotherapy is a feasible and acceptable technique for rural residents to access psychological care in Australia
	Non-experimental		

---

mixed design,  
randomized  
controlled trial.

**Table2. Interventions in Telepsychology**

<b>Researcher(s)</b>	<b>Research Methods</b>	<b>N (Number of Samples)</b>	<b>Research Results</b>
(Weinberg, 2020)	Review the literature of group therapy research online	n. a	Online group therapy is quite successful, it is worth considering the issues of online attachment, the presence of online therapy, and the role of therapeutic alliances in online groups.
(Zwerenz et al., 2017)	Experiment using control group and intervention group	229 depressed patients	Online self-help psychotherapy in the form of behavioral cognitive psychotherapy modules, positive psychology, emotion-focused therapy and dream work can reduce depression and anxiety.
(García et al., 2021)	Qualitative using an interpretive phenomenological approach Experiment	4 practitioners and 3 patients	Online psychotherapy using relational psychoanalysis, gestalt therapy, cognitive
(Watkins et al., 2016)	Literature Review	736 depressed patients	
(Smith et al., 2021)		n.a	

---

			behavioral therapy
			Internet-based cognitive behavioral therapy (CBT) can reduce depressive symptoms
(Fagundes Machado et al., 2020)	Qualitative using an exploratory approach	8 (eight) psychologists	Online psychotherapy requires more in-depth study. Types of online psychotherapy that are widely used are
(Lazuras & Dokou, 2016)	Quantitative using survey	63 (sixty-three) mental health practitioners (Psychologists, Psychological Counselors, Psychotherapists and Psychiatrists)	cognitive behavioral therapy, acceptance-based behavior therapy, etacognitive therapy, and exposure variant therapy. problem solving therapy and humanistic therapy.
(Dowling & Rickwood, 2013)	Systematic Review of articles published between 1995 and 2012. EBSCO database searches were: Academic Search Complete, CINAHL Plus, Psychology and Behavioral Sciences Collection, PsychArticles, and Psych INFO.	Six (6) research	Online psychotherapy using psychodynamic techniques promotes a dynamic process in many ways that is very similar to the face-to-face

---

(Navarro et al., 2020)	Qualitative with pilot study Qualitative	Nine (9) mental health practitioners.	intervention process.  Mental health professionals accept online counseling.
(Prescott et al., 2020)		Twenty-five (25) Facebook Groups)	Online counseling by means of two-way chat is the same as face-to-face counseling. Online chat is effective despite relatively slow sessions and the absence of face-to-face cues (e.g., verbal tone, facial expressions, and body language).  Text-based online counseling (TBOC) is effective for dealing with mental disorders in adolescents.  Online peer therapy uses Facebook Groups to improve mental health.

## **Discussion**

Based on the results of the literature review above, the authors found two points that can be discussed, namely ethical issues and the sustainability of telepsychology in Era Society 5.0.

### **Ethics in Telepsychology**

Telepsychology has the potential to be developed and beneficial for mental health practitioners and service users in Era Society 5.0. Telepsychology has the ability to increase the service area, but standards and procedures, infrastructure readiness, public acceptance, and the digital abilities of psychology specialists or mental health practitioners must all be considered, particularly in Indonesia. It is still required to develop techniques for dealing with ethical difficulties that arise while offering psychological treatments to clients via the internet. Since the usage of letters, telephones, and e-mails, ethical difficulties in telepsychology have developed, and there are currently more applications for online psychological services, particularly in Indonesia.

Described the results of a literature review that there are 24 ethical arguments in favor of online psychotherapy and 32 against [16], the top five ethical arguments in favor of online psychotherapy are (1) increased access to psychotherapy and service availability and flexibility; (2) improved therapeutic and communication benefits; (3) benefits associated with specific client characteristics (eg remote location); (4) convenience, satisfaction, acceptance, and increase in demand; and (5) economic benefits. The top five ethical arguments against engaging in online psychotherapy are (1) issues of privacy, confidentiality, and security; (2) the competence of the therapist and the need for special training; (3) communication issues specific to technology; (4) research gaps; and (5) emergency matters.

Another challenge that mental health professionals face during the telepsychological process is transference, countertransference, empathic mirroring, and containment [13]. When practicing telepsychology in Australia, ethical guidelines must consider various factors, including general requirements, secrecy, authority, and permission [6]. Telepsychology requires permission from an approved institution or group to operate. In the United States, telepsychology is permitted by state law or local rules of conduct, and no state specifically prohibits online therapeutic practice [7].

## **Challenges and Opportunities for Telepsychology in the Era of Society 5.0**

According to the findings of the literature review, technology poses a threat to traditional mental health ideals and practices. The field of psychology has a reputation for being anti-technology. Changes in mental health care as a result of technological advancements would not endanger human values. The outbreak of the Covid-19 pandemic exemplifies the issues that the Society 5.0 idea must face. The ability of Society 5.0 to tackle difficulties that have arisen as a result of the Covid-19 Pandemic. The personality of the Society 5.0 community, which makes use of technology and digital data to foster creativity and happiness in themselves and others.

In concept of psychotechnology (the technology is very useful for providing mental health care), psychologists can attract new clients, perform screening, assessment and various types of therapy (Holländare, Andersson, & Engström, 2010) and offer a variety of services beyond what was previously practical or what was previously practical or usually implemented. Professional psychologists who are appropriately equipped can use telepsychology to not only improve the effectiveness of mental health services, but also to widen the range of services and their understanding of psychology practice. Telepsychology is an alternative for collecting research data outside of the area of practice. Telepsychology in study requires particular concerns, such as ensuring data confidentiality and verifying a person's identification, as well as remote data collecting strategy. First, research and evaluation protocols must be considered. Second, explanation and consent must be considered, which includes informing participants about the nature and purpose of the procedure/research, their ability to opt-out, and the use of their data only with permission. Third, data information security must be considered, which includes keeping data collected through internet surveys safe and only collecting data from clients with their written permission [10].

## **Conclusion**

Telepsychology is a type of alternative mental health service that could be developed as part of Society 5.0 adaption. Technology advancements should be able to improve human well-being. Thus, psychology, as a science that analyzes human behavior, must coexist alongside technology. The application of telepsychology for advancement in the field of psychology is still unexplored. Therefore,



it is impossible to escape the intersection of psychology and technology. Each psychologist must decide for themselves whether, when, and how to use technology. Similarly, every professional association and organization must determine whether to provide the resources required, to accelerate technology adoption, or to prioritize other disciplines.

## References

- [1] Bolton, A. J., & Dorstyn, D. S. (2015). Telepsychology for Posttraumatic Stress Disorder: A systematic review. *Journal of Telemedicine and Telecare*, 21(5), 254–267. <https://doi.org/10.1177/1357633X15571996>
- [2] Coughtrey, A. E., & Pistrang, N. (2018). The effectiveness of telephone-delivered psychological therapies for depression and anxiety: A systematic review. *Journal of Telemedicine and Telecare*, 24(2), 65–74. <https://doi.org/10.1177/1357633X16686547>
- [3] Dorstyn, D. S., Saniotis, A., & Sobhanian, F. (2013). A systematic review of telecounseling and its effectiveness in managing depression amongst minority ethnic communities. *Journal of Telemedicine and Telecare*, 19(6), 338–346. <https://doi.org/10.1177/1357633X13501767>
- [4] Dowling, M., & Rickwood, D. (2013). Online counseling and therapy for mental health problems: A systematic review of individual synchronous interventions using chat. *Journal of Technology in Human Services*, 31(1), 1–21. <https://doi.org/10.1080/15228835.2012.728508>
- [5] Fagundes Machado, L., Paris Feijó, L., & Barcellos Serralta, F. (2020). Online psychotherapy practice by psychodynamic therapists. *Psico*, 51(3), e36529. <https://doi.org/10.15448/1980-8623.2020.3.36529>
- [6] Gamble, N., Boyle, C., & Morris, Z. A. (2015). Ethical Practice in Telepsychology. *Australian Psychologist*, 50(4), 292–298. <https://doi.org/10.1111/ap.12133>
- [7] Haberstroh, S., Barney, L., Foster, N., & Duffey, T. (2014). The Ethical and Legal Practice of Online Counseling and Psychotherapy: A Review of Mental Health Professions. *Journal of Technology in Human Services*, 32(3), 149–157. <https://doi.org/10.1080/15228835.2013.872074>
- [8] Holmes, N. A., van Agteren, J. E. M., & Dorstyn, D. S. (2019). A systematic review of technology-assisted interventions for co-

- morbid depression and substance use. *Journal of Telemedicine and Telecare*, 25(3), 131–141. <https://doi.org/10.1177/1357633X17748991>
- [9] Lazuras, L., & Dokou, A. (2016). Mental health professionals' acceptance of online counseling. *Technology in Society*, 44, 10–14. <https://doi.org/10.1016/j.techsoc.2015.11.002>
- [10] McCord, C., Bernhard, P., Walsh, M., Rosner, C., & Console, K. (2020). A consolidated model for telepsychology practice. *Journal of Clinical Psychology*, 76(6), 1060–1082. <https://doi.org/10.1002/jclp.22954>
- [11] Navarro, P., Sheffield, J., Edirippulige, S., & Bambling, M. (2020). Exploring mental health professionals' perspectives of text-based online counseling effectiveness with young people: Mixed methods pilot study. *JMIR Mental Health*, 7(1). <https://doi.org/10.2196/15564>
- [12] Prescott, J., Rathbone, A. L., & Brown, G. (2020). Online peer to peer support: Qualitative analysis of UK and US open mental health Facebook groups. *Digital Health*, 6, 1–17. <https://doi.org/10.1177/2055207620979209>
- [13] Sayers, J. (2021). Online Psychotherapy: Transference and Countertransference Issues. *British Journal of Psychotherapy*, 37(2), 223–233. <https://doi.org/10.1111/bjp.12624>
- [14] Simpson, S., Guerrini, L., & Rochford, S. (2015). Telepsychology in a University Psychology Clinic Setting: A Pilot Project. *Australian Psychologist*, 50(4), 285–291. <https://doi.org/10.1111/ap.12131>
- [15] Smith, K., Moller, N., Cooper, M., Gabriel, L., Roddy, J., & Sheehy, R. (2021). Video counselling and psychotherapy: A critical commentary on the evidence base. *Counselling and Psychotherapy Research*, June, 1–6. <https://doi.org/10.1002/capr.12436>
- [16] Stoll, J., Müller, J. A., & Trachsel, M. (2020). Ethical Issues in Online Psychotherapy: A Narrative Review. *Frontiers in Psychiatry*, 10(February), 1–16. <https://doi.org/10.3389/fpsy.2019.00993>
- [17] Varker, T., Brand, R. M., Ward, J., Terhaag, S., & Phelps, A. (2018). Efficacy of Synchronous Telepsychology Interventions for People With Anxiety, Depression, Posttraumatic Stress Disorder, and Adjustment Disorder: A Rapid Evidence Assessment. *Psychological Services*, May. <https://doi.org/10.1037/ser0000239>
- [18] Watkins, E., Newbold, A., Tester-Jones, M., Javaid, M., Cadman, J.,

- Collins, L. M., Graham, J., & Mostazir, M. (2016). Implementing multifactorial psychotherapy research in online virtual environments (IMPROVE-2): Study protocol for a phase III trial of the MOST randomized component selection method for internet cognitive-behavioural therapy for depression. *BMC Psychiatry*, 16(1), 1–13. <https://doi.org/10.1186/s12888-016-1054-8>
- [19] Weinberg, H. (2020). Online group psychotherapy: Challenges and possibilities during COVID-19-A practice review. *Group Dynamics*, 24(3), 201–211. <https://doi.org/10.1037/gdn0000140>
- [20] Zwerenz, R., Becker, J., Knickenberg, R. J., Siepmann, M., Hagen, K., & Beutel, M. E. (2017). Online Self-Help as an Add-On to Inpatient Psychotherapy: Efficacy of a New Blended Treatment Approach. *Psychotherapy and Psychosomatics*, 86(6), 341–350. <https://doi.org/10.1159/000481177>

# **Blended Learning in Islamic Education Learning: Moderate Learning Model in Society 5.0**

Ruslan<sup>100</sup>, Luthfiyah<sup>101</sup>

## **Introduction**

Islamic Education is one of the subjects in every level of education from elementary school to university showing its urgency and playing a role in shaping religious behavior. Islamic Education learning online in the Covid-19 era faces many problems both related to knowledge and changes in student behavior. Regarding knowledge, students cannot perfectly accept the material delivered by the teachers because of technical problems such as network constraints, very minimal internet data, and the limited ability to use zoom meetings, google meet, and WhatsApp as media for educative interactions [1]. Meanwhile, in the behavioral aspect, students cannot be directly controlled by the teachers, they behave deviant because the teachers are not paying attention, while their parents are busy. Due to weak parental supervision at home, students have the freedom to use Android (supposedly only used for online learning) to play games.

Likewise with Islamic Education learning with a face-to-face approach. This learning model approach in society 5.0 is basically outdated because it is not relevant to technological developments. Face-to-face learning as the only approach in Islamic Education learning is not the right choice, considering the development of the internet world demands a contextual and adaptive learning approach [1]. By not adopting the latest learning media, such as Zoom Meeting, Google Meet, WhatsApp, and other media, makes Islamic Education learning alienated from education in general.

Based on these problems, Islamic Education learning, both in the Covid-19 and post-Covid-19 eras, needs to be reformulated so that the effectiveness and achievement of learning objectives can be achieved. Islamic Education Learning using a monotonous approach, such as face-to-face (offline) is considered irrelevant to technological developments, especially in society 5.0. Therefore, education in essence must be able to adapt to the social life and experiences of

---

<sup>100</sup> Universitas Muhammadiyah Bima

<sup>101</sup> Universitas Muhammadiyah Bima

students [2]. In this context, blended learning is needed because it can combine by accommodating the two learning models, namely face-to-face and online, or can combine the two learning approaches [3]. The learning approach combining face to face and online (blended learning) is considered to be able to improve learning achievement [4]. In fact, Lee recommended combining the online, offline, and blended learning models alternately. By applying a blended learning approach, teachers can use technology practically to motivate students to develop professionally both technological and academic skills [4]-[5]. All teachers face the challenge of implementing a new learning model integrating ICT and online learning. In dealing with all of these problems, teachers need to improve their competence so that they are relevant to the learning objectives of the contemporary era [5].

This paper has significance in society 5.0 because it can be viewed from several points, namely: 1) recommending a new strategy in Islamic Education learning through a blended learning model; 2) responding to the demands of society 5.0 by offering various and adaptive Islamic Education learning strategies; 3) giving birth to new innovations in designing the post-covid 19 Islamic Education learning model through the idea of blended learning as a moderate learning model.

## **Discussion**

### **Islamic Education Learning: Idea and Reality**

Islamic Education is a subject with a very broad scope of discussion because it is based on universal Islamic values containing the normative teachings of the Islamic religion including faith, morals, sharia, and history [6]. This means Islamic Education has comprehensive material coverage. Therefore, teachers have an important role in instilling understanding and determining the learning model in students. Teachers must be able to determine competency development strategies and learning materials [7] by innovating, integrating and using learning support facilities [8] to get the most effective and efficient results.

During the COVID-19 pandemic when schools were closed, all teachers faced challenges in getting to know new learning models integrating ICT and online learning. According to Johannes [5] teachers are required to be able to organize an education system using ICT transformation so that they are able to close the gap between conventional learning systems and development in schools by

providing the experience and skills needed by students. Even before the lockdown, almost all teachers (98%) in Germany had used a virtual learning system, either via email, WhatsApp, or other social media. This shows that the use of digital devices such as smartphones can still represent the communication between teachers and students and parents [5].

However, current learning emphasizes more on learning about things than on learning how to be. This means learning is only oriented to delivering material to students, without paying attention to how the material is absorbed and understood. In the context of Islamic Education learning, in addition to understanding, practice is also needed, because it is related to worship. Therefore, according to Sugiana, the success of the education process is determined by learning design, strategy design, and curriculum design.

The use of blended learning is an option to be applied in Islamic Education learning considering that it can be both theoretical and practical. Theoretical content can be delivered through online learning, so that material files can be stored so that they can be read or understood again when needed. In addition, the material can also be presented in varied formats so that it does not cause saturation and is not monotonous. Meanwhile, practical content can be performed through blended learning, where teachers can practice directly or video can be made to be watched over and over again. Thus, students can better understand the practical ways of worship as well as easily apply them in daily life.

### **Blended Learning in Society 5.0**

Blended learning is a combination of face-to-face learning with online learning or via the internet [9] [10]. Paul contradicted the blended learning with traditional learning meaning blended learning is a modern learning design paired with digital technology and is much more interesting than traditional learning. This is because students today are indeed born as the millennial generation, where the use of the internet and computers with various applications has become part of everyday life. Therefore, the learning process is also required to use new learning methods, in order to improve the learning quality.

The traditional learning model consists of three elements; teachers, students, and materials. Currently, learning is required to use other elements, namely technology and ICT. Likewise, the roles of teachers and students have also changed. In contemporary concepts,

students play an active role as learning subjects. When using e-learning technology, students become learner-centered in determining learning materials, methods and strategies. Thus, students are more active, critical, and creative and able to become problem solvers [9].

Online learning and blended learning models can provide benefits for students in terms of increasing knowledge, having fun experiences, and growing enthusiasm for learning [11]. Similar to above, Chantelle [12] showed that the use of blended learning can increase interest and attention, improve cognitive competence, foster enthusiasm to try harder in learning, contain use values to understand the material and be motivated to study harder [12].

Blended learning can improve the ability to learn independently, apply practically, and be able to innovative. The concept of blended learning applies the principle of "student-centered" with the aim of optimizing learning efficiency, giving full initiative, enthusiasm and creativity to students, while still combining it with the F2F pattern. In addition, the active role of teachers is still functioned to direct, inspire and control the learning process with the aim of forming independent learning [13].

Thus, blended learning indicates the formation of being able to adapt to society 5.0 where one needs to develop all the potential in order to be able to face the challenges of life by placing humanity as the main pillar as well as being adaptive to technological transformation. For society 5.0, every human being is a key element capable of integrating virtual space and real space in order to obtain progressive benefits.

Society 5.0 can be characterized in several ways, including: first, society 5.0 places humans at the center of innovation and technology integration to improve the quality of life; second, society 5.0 responds to the evolution of technology, information and communication by bringing about drastic changes in economic growth and technological development; third, placing society as the center of economic progress in a balanced way through solving social problems by integrating cyberspace systems and the real world; fourth, placing the community as the focus of attention and using technology as a means of enjoyable life necessities; Fifth, society 5.0 as a development of society 4.0 pays attention to relevant community aspects and challenges to innovate in responding to technological transformation based on human principles [14].

Society 5.0 or smart society is a human-centered society with problem-solving resolution through an integrated system between virtual and real space [14]. Society 5.0 is very humanist, humanizes humans, and does not demean human dignity [14]. Thus, blended learning answers the demands of society 5.0 because a teacher is required to be able to combine cyberspace systems and the real world, between human and technology elements, and between online and offline. In addition, the role of humans in blended learning is also the main element in determining the choice of material to be given F2F and online, the methods and strategies used and the facilities needed.

### **Blended Learning as Moderate Choice**

Basically, blended learning is a middle way in the learning process combining online and offline learning models. The choice of using the two interchangeably can be based on material needs or the demands of situations and conditions. Therefore, a teacher must be able to choose and sort out when and why blended learning can be used with the above considerations. In fact, according to Carmen, in determining the learning model, it is not only what and how, but also by whom and why, so as to develop knowledge professionally. Carmen emphasized the importance of using a pedagogical approach through collaborative learning components by developing online and face-to-face systems.

The moderate element in blended learning can at least be interpreted from several values contained in the moderation term, namely: wasathiyah, ta'adul and tawazun. Wasathiyah shows that blended learning takes a middle ground by pursuing two models at once covering online and offline. Wasathiyah shows the learning process does not only choose one of online and offline learning, but both can be used interchangeably and simultaneously.

Tawazun means simultaneous [15]. In blended learning, it can be interpreted that Islamic Education learning needs to balance between online and offline learning, of course taking into account the situation and interests of the Islamic Education material itself. Balancing between online and offline use based on the demands of the material is an implementation of fairness (ta'adul). Fairness here does not mean that the use of learning must be the same in the number of meetings, but it means that it must be in accordance with the required portion by classifying it proportionally.

The word "moderate" is derived from the word "moderation" as an adjective form. Moderation is synonymous with tolerance and



openness [16]-[17]. This identification also characterizes society 5.0 as synonymous with open and inclusive society as well as tends to use an experimental approach to reconstruct and improve lifestyles. This means when applying blended learning, it is hoped that it will indirectly shape a person to be open to change and tolerant of differences. The experience of undergoing blended learning at school will enrich the learning strategy.

Moderation is the opposite of extremes and exaggeration [15], as well as puritan [17]. In the context of blended learning, moderation is defined as a choice to use a learning model not to be extreme in one model and anti-other. Moderate attitude also arises when learning does not adhere to an old conventional model and rejects the new with excessive rejection and excessive support. Thus, it can be emphasized that blended learning is a moderate learning model as an alternative learning model to answer the demands of society 5.0.

## **Conclusion**

During the COVID-19 pandemics, in the context of education, schools closed face-to-face meetings and switched to using technological innovations and digitalization. This condition requires teachers to have digital skills and implement ICT-based learning. After the COVID-19 pandemic and schools were re-opened and allowed to carry out F2F learning, education stakeholders were given a choice in the learning process, either online or offline.

This paper recommends a middle way as a learning option through a blended learning model. This choice is based on the assumption that society 5.0 requires integration between cyberspace systems and the real world, placing humans as the main element while still involving elements of technology as a complement. The use of blended learning can balance pedagogical competence and technological competence. In addition, it can also foster critical thinking, creativity, interest in learning, learning independence, and motivation to move forward and achieve goals in obtaining maximum learning outcomes.

Blended learning is a moderate choice because it combines two learning models proportionally and conditionally. There is no excessive tendency in the use of the two learning models as well as no discrimination and elimination between the two. This choice will later deliver Islamic Education learners to have academic knowledge as

well as experience in using technology, as an adaptive step to the demands of society 5.0.

## References

- [1] M. Paechter and B. Maier, "Online or face-to-face? Students' experiences and preferences in e-learning," *Internet High. Educ.*, vol. 13, no. 4, pp. 292–297, 2010, doi: 10.1016/j.iheduc.2010.09.004.
- [2] M. A. Ashraf, "Islamized ideologies in the Pakistani education system: The need for religious literacy," *Relig. Educ.*, vol. 113, no. 1, pp. 3–13, 2018, doi: 10.1080/00344087.2017.1384971.
- [3] H. Shu and X. Gu, "Determining the differences between online and face-to-face student–group interactions in a blended learning course," *Internet High. Educ.*, vol. 39, no. 2017, pp. 13–21, 2018, doi: 10.1016/j.iheduc.2018.05.003.
- [4] S. C. Yen, Y. Lo, A. Lee, and J. M. Enriquez, "Learning online, offline, and in-between: comparing student academic outcomes and course satisfaction in face-to-face, online, and blended teaching modalities," *Educ. Inf. Technol.*, vol. 23, no. 5, pp. 2141–2153, 2018, doi: 10.1007/s10639-018-9707-5.
- [5] J. König, D. J. Jäger-Biela, and N. Glutsch, "Adapting to online teaching during COVID-19 school closure: teacher education and teacher competence effects among early career teachers in Germany," *Eur. J. Teach. Educ.*, vol. 43, no. 4, pp. 608–622, 2020, doi: 10.1080/02619768.2020.1809650.
- [6] A. Muhith, "Model of Strengthening the Pedagogic Competence of Islamic Religious Education Teachers in Improving the Quality of Education in Junior High Schools in Jember Regency," *J. Pendidik. Agama Islam*, vol. 18, no. 1, pp. 125–144, 2021, doi: 10.14421/jpai.2021.181-07.
- [7] A. Kadir and U. Umiarso, "Evaluation of the Application of Distance Learning Programs in Madrasah Aliyah Malang Regency," *J. Pendidik. Agama Islam*, vol. 18, no. 1, pp. 109–124, 2021, doi: 10.14421/jpai.2021.181-06.
- [8] E. Latipah, H. C. A. Kistoro, and H. Putranta, "The Effects of Positive Parenting toward Intolerance in Pre-School Children," *Int. J. Early Child. Spec. Educ.*, vol. 12, no. 2, pp. 137–146, 2020, doi: 10.9756/INT-JECSE/V12I2.201065.
- [9] S. Mohorovičić and E. Tijan, "Blended learning model of teaching programming in higher education," *Int. J. Knowl. Learn.*, vol. 7, no. 1–2, pp. 86–99, 2011, doi: 10.1504/IJKL.2011.043893.

- [10] A. Tayeb, *Islamic Education in Indonesia and Malaysia*. 2018.
- [11] C. J. Asarta and J. R. Schmidt, "The effects of online and blended experience on outcomes in a blended learning environment," *Internet High. Educ.*, vol. 44, no. September 2019, p. 100708, 2020, doi: 10.1016/j.iheduc.2019.100708.
- [12] C. Bosch, E. Mentz, and G. M. Reitsma, "Integrating cooperative learning into the combined blended learning design model: Implications for students' intrinsic motivation," *Int. J. Mob. Blended Learn.*, vol. 11, no. 1, pp. 58–73, 2019, doi: 10.4018/IJMBL.2019010105.
- [13] Y. Tong, Kinshuk, and X. Wei, "Teaching design and practice of a project-based blended learning model," *Int. J. Mob. Blended Learn.*, vol. 12, no. 1, pp. 33–50, 2020, doi: 10.4018/IJMBL.2020010103.
- [14] D. 2021 Daryono, "Society 5.0 Fostering Spirituality and Humanity," *Proc. Int. Semin. Soc. 5.0 Foster. Spiritual. Humanit.*, p. 275, 2021.
- [15] M. A. Najib and A. K. Fata, "Islam Wasatiah dan Kontestasi Wacana Moderatisme Islam di Indonesia," *J. Theol.*, vol. 31, no. 1, p. 115, 2020, doi: 10.21580/teo.2020.31.1.5764.
- [16] B. Z. Yanti and D. Witro, "Islamic moderation as a resolution of different conflicts of religion," vol. 8, no. 1, pp. 446–457, 2020.
- [17] U. Husna and M. Thohir, "Religious Moderation as a New Approach to Learning Islamic Religious Education in Schools," *Nadwa J. Pendidik. Islam*, vol. 14, no. 1, pp. 199–222, 2020, doi: 10.21580/nw.2020.14.1.5766.

# Framing English Language Teacher in Facing Society 5.0: Challenges and Adaptive Strategy

Salasiah Ammade<sup>102</sup>, Khairil<sup>103</sup>

## Introduction

Society 5.0 has been arisen up by Japan, and it was being a core concept in the 5<sup>th</sup> Science and Technology Basic Plan, adopted by Japan cabinet 2016. The term *society* itself refers to a group of people who form in a semi-closed or semi-open system which the interaction is mostly done between individuals within the group. The fast change of society put the categorization of society from times to times like society 5.0 showing the fifth form of society in the history of human life development. The journey of society changes will be described in detail to show how fast the society changes in the world.

Society 1.0 as the first society in the human life development start the life journey by forming a group into society. In this type of society, humans defend their life by hunting for food and live in unstable location. They move from place to place to keep surviving. Their life is very simple as they make simple tools and provide themselves with natural forces such as using fire to cook and prevent themselves. Next society level is society 2.0 which refers as the era of agriculture. Humans focus on developing science via farming as the basic reason for not moving from one place to another place. In this society, people tried living permanently and building more complex society. They maintain their life survival by making their own food source through farming. Also, this society starting thinking complex in developing their life value by building various kingdoms, writing was introduced, and big cities began to emerge.

Society 3.0 as the next society showed more complex life as the number of people increased, and subsequently followed by the high need of food and clothing. The existing knowledge humans have in the society lead them to build factories as places to produce their life needs and they began acknowledging with wage system. As fast development of science and technology, people get familiar with computer and internet in obtaining quick information and society 4.0 is recognized in this type of zone. The data flow moves rapidly and

---

<sup>102</sup> Universitas Muhammadiyah Parepare

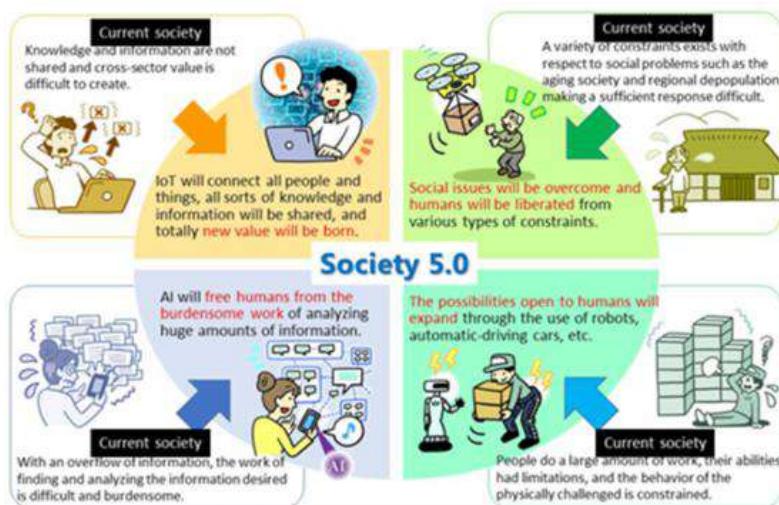
<sup>103</sup> SMA Negeri 3 Parepare

affect the human life like borderless between space and time. In this technological era, industry competition races to produce products that assist human to live more easily and access the information quickly.

As a refinement of society 4.0. next level society starting to emerge; society 5.0. Here, technology becomes part of human life, not only as part of information sharing, but also as assistant of life. Society 5.0 puts technology as life partner and stresses integrated, easy, and fast living. In education for example, many Artificial Intelligence (AI) tools are ready to ease education sector; tools to paraphrase, translate, summarize, speaking, and many others. The society 5.0 makes human's life more practical and automatic. Humanizing technology is the basic idea in this type of society as technology does not control people life but human take the good of technology to comfy their life.

Talking about education within society 4.0 and society 5.0, nowadays, in education world, the integration of technology within school zone is inevitable and its peak integration revealed last year since COVID-19 pandemic. All sectors of life got impacted of the pandemic as lock down regulation is implemented in entire world including in Indonesia. Yet, education world has to continue even in hardest time like COVID-19 pandemic, and technology integration in teaching learning process has shown its big assistance in it [1]. Online and off line learning using technology is being the main weapon in continuing education during this pandemic[2]. Teachers as front-line basis is driven to literate in technology to keep maintaining the running of education [3]. This is big challenge for them as previously technology is just in small part of education. Teaching learning process is done via face-to-face meeting with little touch of technology such as just to look for additional learning material or for administration issue. Teachers get used to traditional classroom, limited usage of technology for years. The next picture shows how society 5.0 works in human's life.

**Figure 1. How society 5.0 works in society**



Picture us taken from [https://www8.cao.go.jp/cstp/english/society5\\_0/index.html](https://www8.cao.go.jp/cstp/english/society5_0/index.html)

The rapid movement of technology in society 4.0 and society 5.0 position teachers to get familiar with technology and try to incorporate it into their teaching. Yet teachers still face many challenges in doing it for some reasons. Therefore, when COVID-19 attacks the world and technology takes over most system of education, teachers are driven to use technology into their teaching. Teachers are forced to be literate in technology to keep the continuity of learning[1];[2];[4];[5]. Therefore, in facing the era of society 5.0, teachers should be well prepared particularly on technology literacy. This paper will describe challenges the teachers may face in adjusting their teaching in society 5.0 and the adaptive strategy teachers should prepare in facing it.

### Discussion

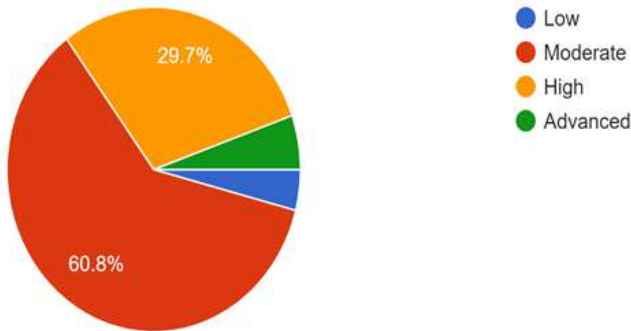
Talking about life adjustment in facing society 5.0, human must prepare them selves to face it. Challenges in facing it is unavoidable for all life sectors mainly for education part. The teacher as main part of education also needs good preparation in adjusting their teaching within society 5.0 to avoid culture shock and bad things

that may occurred. Besides, preparing adjustment strategy in facing the challenges is another important aspect to prepare. This part will describe challenges and adaptive strategy in facing society 5.0 for teachers.

### Teacher's challenges in facing society 5.0

Society 5.0 as refinement era of society 4.0 stresses much on technology adaption in human life. In education part, technology integration has reached its peak during COVID-19 pandemic. Online learning was the main option in keeping the running of education, and technology literacy is being a must to have for teacher. Digital technology literacy the teachers possess is vary between teacher, and many teachers are still in moderate level and need to be improved. The figure below will show digital literacy of the teacher based on questionnaire distributed to teachers in Indonesia during pandemic.

**Figure 2. Teacher's digital technology literacy**



The pie chart above revealed digital literacy from respondent teachers of online questionnaire distributed to them during COVID-19 pandemic. There are 74 teachers of different teaching level from different parts of Indonesia responded regarding the question of digital literacy categorization from low to advanced level. As seen on the figure 1, moderate level (60.8 %) is the highest level of teacher digital literacy followed respectively by high level (29.7 %), advanced level (5.4 %) and low level (4.1%). It is clearly seen in the pie chart that teachers' knowledge of technology is still in medium average,

whilst the need of technology knowledge the teachers supposed to possess is in high demand regarding the coming of society 5.0. Having moderate level of technology knowledge is one challenge facing by teachers in Indonesia as technology knowledge is one main key in being successful teacher in this society[6].

Teaching location is other challenge facing by Indonesian teacher in welcoming society 5.0. Some areas in Indonesia are still categorized as remote, far, and isolated area. Teachers in this area is still far from technology touch in their school. Technology is exclusive tool for teachers and students in this area and hinder teachers and students in full integration of technology. If the teaching location is hard to reach by technology, low tech integration in teaching will occur, and certainly, traditional classroom is still dominated. In this kind of challenge, full technology incorporation seems hard to make it real, but little touch of it is can be tried. Hitherto, Limited interaction with technology in remote, far, and isolated area can be still organized to be implemented maximally if good collaboration between teacher and student can be done[7].

The next challenge in facing society 5.0 for teachers deals with internal connection/signal. Having good internet connection in learning will smooth the continuity of learning as well as ease the learners in assessing information in the internet. In Indonesia, many parts are still having bad connection of internet. The data from e-questionnaire distributed to teachers of Indonesia exposed teachers in some areas fronting unstable connection and poor connection which affect the teaching and learning particularly during pandemic. Online learning as main way to teach in this case is not fully attended by students as a result of unstable connection in their area. Many students in poor internet connection area struggled in looking for stable connection by going to other nearest area of their living. So, it can be assumed here that having good and stable internet connection will assist teachers in facing the challenges in society 5.0[8].

Further challenge in facing society 5.0 is economy aspect or financial stuff within education world. Fast speedy of technology development forces teachers as well as students to equip themselves with technology tools including internet connection to access information[9]. In Indonesia, different range of human's economic background make not all teachers and students can prepare good technology tool as well as internet connection as part of education. The research result done last year (2020) by giving questionnaire to teachers showed that their students got problem in buying internet



connection because low budget for it. Besides, not all students can afford having gadget as part of online learning because it is still expensive thing to have comparing to their earning of money [10].

Way of teaching is also a challenge for teachers in facing society 5.0. Integrating technology in teaching seems being a must for teachers to teach digital learners in this era. Involving in their digital world can be done by incorporating technology into their pedagogy. During pandemic, teachers admitted they need to be more creative in teaching to gain students' interest as during online class, students' concentration is only stable for around ten minutes and the rest of teaching time needs hard work of the teachers to keep it still. Making enjoyable class in digital learners needs firm effort from the teachers [11] as they state 'I have to teach more creative and using technology lots in teaching'.

Students' knowledge of technology is considered a challenge as well in this digital world. Teachers with good technology knowledge will work well in the classroom if accompanied by digital literate students. Teachers in Indonesia based on online survey acknowledged that students are lack of mastery on digital technology, internet signal, and their limited facility of handphones. Also, not all students can join online learning and teaching process because unstable internet connection and lack of funding to buy internet quota. These factors make students lost focus on learning and difficult to control them in learning.

### **Adaptive strategy in facing the challenge**

Anticipating the challenge teachers may face in society 5.0, adaptive strategy can be considered to have better readiness to be in this digital society. The first adaptive strategy for teachers is maximized the knowledge of technology, pedagogy, and content (TPACK) in teaching. TPACK is a framework to understand and describe the kind of knowledge needed by a teacher for effective pedagogical practice in a technology enhanced learning environment [12]. The framework is completed the knowledge possessed by teacher in facing digital learning environment. It focuses on technology integration in teaching which link to the pedagogy implementation in teaching the content [13]. TPACK framework stresses the ability of teachers in making use of technology associated with their way of teaching the content material. If the teacher has good TPACK, challenge in teaching in digitalized world can be minimized.

Next strategy in facing the challenge regarding teaching location is facilitating internet network in all areas in Indonesia including far, remote, and isolated area. Although teaching location is far and remote, but if it is provided with internet network, teachers students can access information via internet[14]. They can update their knowledge by the ease of information access, and they can develop their world horizon. The internet stability is also can be handled if the internet network is built and managed properly by government. As a result of well-internet facilitation, teachers can upgrade themselves with ICT competencies and positive attitude to provide ICT-based learning opportunities for students to improve their learning quality [7][15].

Teacher Professional Development (TPD) can be helpful strategy for teacher in adapting education changes in society 5.0. Providing teacher training to enrich knowledge for their teaching will help teachers to teach better. In relation to digital world in society 5.0, Teachers need to be provided with many trainings on technology assisted learning as today's education world is focused in making use of technology in learning [16]. If teachers are not upgrading their technology knowledge as well as pedagogy and content knowledge, they will be left behind and hard to adopt with rapid education changes. Fortunately, nowadays, many free professional developments training has been organized by education agents and it can be joined freely and virtually. The easiness to access this education training via webinar in internet assist teachers a lot in upgrading their teaching performance.

In handling students' lack of technology assistance like internet connection readiness or technology tools availability in society 5.0, coping strategy is truly needed. During COVID-19 pandemic, the need of technology in maintaining the learning process is in high demand and internet connection completes the learning[17]. Indonesia Government are aware on this necessity, and providing funding for internet connection since pandemic starts. Teachers in all level of education get regular funding for internet quota/allowance as well as students. The funding of internet assists teachers and students in continuing the learning. The internet quota package funding still covers limitation in the usage as it is just for education access like meeting platform of google meet, zoom, education application except for social media, video and game apps. For future use, internet funding package is still hoping to be provided by the government to enlighten the society burden in this technological society.

## Conclusion

In wrapping up the writing above, facing society 5.0 in education will bring some challenges for teachers. Having moderate level of technology knowledge, teaching location in far, remote and isolated area, internet connection availability, financial stuff issue or low economy income, and lack innovation of teaching and students' knowledge of technology are deviances teachers of Indonesia can face in this digital society. Therefore, coping strategy is needed to face it. Maximizing the knowledge of technology, pedagogy, and content (TPACK) in teaching, facilitating internet network in all areas in Indonesia including far, remote, and isolated area, Training for Teacher Professional Development (TPD), internet connection readiness or technology tools availability, and internet funding package.

## References

- [1] K. M. Moser, T. Wei, and D. Brenner, "Remote teaching during COVID-19: Implications from a national survey of language educators," *System*, vol. 97, p. 102431, Apr. 2021, doi: 10.1016/J.SYSTEM.2020.102431.
- [2] J. Li, C. Qin, and Y. Zhu, "Online teaching in universities during the Covid-19 epidemic: a study of the situation, effectiveness and countermeasures," *Procedia Comput. Sci.*, vol. 187, pp. 566–573, Jan. 2021, doi: 10.1016/J.PROCS.2021.04.100.
- [3] T. Pressley and C. Ha, "Teaching during a Pandemic: United States Teachers' Self-Efficacy During COVID-19," *Teach. Teach. Educ.*, vol. 106, p. 103465, Oct. 2021, doi: 10.1016/J.TATE.2021.103465.
- [4] S. Purnama, M. Ulfah, I. Machali, A. Wibowo, and B. S. Narmaditya, "Does digital literacy influence students' online risk? Evidence from Covid-19," *Heliyon*, vol. 7, no. 6, p. e07406, Jun. 2021, doi: 10.1016/J.HELİYON.2021.E07406.
- [5] A. Tham, B. L. Iaquinto, and S. Driml, "Navigating external referencing through COVID-19 disruptions - Teaching tourism policy and planning in Australia and China," *J. Hosp. Leis. Sport Tour. Educ.*, p. 100350, Oct. 2021, doi: 10.1016/J.JHLSTE.2021.100350.
- [6] P. K. R. Maddikunta *et al.*, "Industry 5.0: A survey on enabling technologies and potential applications," *J. Ind. Inf. Integr.*, p. 100257, Aug. 2021, doi: 10.1016/J.JII.2021.100257.

- [7] S. Ghavifekr, Ahmad Zabidi Abd Razak Muhammad Faizal A. Ghani, Ng Yan Ran, Yao Meixi, and Zhang Tengyue, "ICT Integration In Education: Incorporation for Teaching & Learning Improvement," in *Malaysian Online Journal of Educational Technology*, 2014, vol. 2, no. 2, pp. 24–54, [Online]. Available: <http://www.mojet.net/article.php?volume=2&issue=2&vid=34&article=80>.
- [8] C. (2016). Aslan, A. & Zhu, "Influencing Factors and Integration of ICT into Teaching Practices of Pre-service and Starting Teachers," in *International Journal of Research in Education and Science*, 2016, vol. 2, no. 2, pp. 359–370.
- [9] N. B. Dastjerdi, "Factors Affecting ICT Adoption among Distance Education Students based on the Technology Acceptance Model—A Case Study at a Distance Education University in Iran," in *International Education Studies*, 2016, vol. 9, no. 2, p. 73, doi: 10.5539/ies.v9n2p73.
- [10] F. George and M. Ogunniyi, "Teachers' Perceptions on the Use of ICT in a CAL Environment to Enhance the Conception of Science Concepts," in *Universal Journal of Educational Research*, 2016, vol. 4, no. 1, pp. 151–156, doi: 10.13189/ujer.2016.040119.
- [11] K. U. Isisag, "The Positive Effects of Integrating ICT in Foreign Language Teaching," in *ICT for Language Learning*, 2012, vol. 5, pp. 1–4, [Online]. Available: [http://conference.pixel-online.net/ICT4LL2012/common/download/Paper\\_pdf/235-IBT107-FP-Isisag-ICT2012.pdf](http://conference.pixel-online.net/ICT4LL2012/common/download/Paper_pdf/235-IBT107-FP-Isisag-ICT2012.pdf).
- [12] P. Mishra and M. J. Koehler, "Technological pedagogical content knowledge: A framework for teacher knowledge," *Teachers College Record*. 2006, doi: 10.1111/j.1467-9620.2006.00684.x.
- [13] C. S. Chai, J. H. L. Koh, and C. C. Tsai, "Facilitating preservice teachers' development of technological, pedagogical, and content knowledge (TPACK)," *Educ. Technol. Soc.*, 2010.
- [14] Wagheeh Shukry Hassan, "Teachers' adoption of information and communications technology for teaching and learning in Malaysia: An ecological-complexity analysis of a professional development innovation," p. 341, 2010.
- [15] S. H. Khan, "A model for integrating ICT into teacher training programs in Bangladesh based on TPCK Shahadat Hossain Khan University of Sydney , Australia," in *International Journal of Education and Development using Information and Communication Technology*, 2014, vol. 10, no. 3, pp. 21–31.
- [16] B. F. D. Barrett, A. DeWit, and M. Yarime, "Japanese smart cities

and communities: Integrating technological and institutional innovation for Society 5.0," *Smart Cities Technol. Soc. Innov.*, pp. 73–94, Jan. 2021, doi: 10.1016/B978-0-12-818886-6.00005-8.

- [17] R. H. Jones, "Digital literacies for language teachers: Beyond competencies," *Recent Issues English Lang. Educ. Challenges Dir.*, 2014.

# Vocational High School Learning in Era 5.0

Singgih Prastawa

## Introduction

Education is the foundation for the life of the nation. The foundation is needed because it supports all lines in people's lives in general. The purpose of this national education is expected to be able to produce Human Resources who have the ability to communicate, work productively, have the life skills to determine work priorities, evaluate themselves, manage time and solve problems in accordance with the skills needs of the 21st century (21st century skill). [15]. The buffer stands firmly to strengthen all levels of education, both early childhood education, primary and secondary education as well as higher education in University. at the level of PAUD education, consisting of (Pre school) PAUD and (Kindergarten) TK. Meanwhile for primary and secondary educations consist of learning units in (Junior High School) SMP, (Senior High School) SMA and (Vocational High School) SMK. For vocational education is now experiencing an increase in learning options of community because by going to Vocational High School (SMK), after students graduate, they will get jobs according to their fields. [1] The effectiveness of vocational education can also be examined from the extent of graduates absorbed in the workplace or to be an entrepreneur. Regardless of getting a job after graduating from Vocational High School, people think that they should work with the skills based on previously learned competencies. Vocational High School graduates can also continue to a higher level, namely by further study at university. Vocational High School (SMK) is a vocational education institution that aims to prepare students to become competent and independent workers by prioritizing abilities and skills in certain fields according to their majors. Vocational High School is a type of secondary education that specifically prepares its graduates to become skilled and trained in workforce [15].

In addition to the skills possessed, SMK graduates will easily adapt to industrial society. It is not surprising that the achievements of vocational high school graduates are equipped with hard skills and soft skills. Not only that, SMK graduates are also prepared to enter the world of work and industry earlier by providing them with competencies and skills in pre-employment, namely through a dual system education pattern. In this achievement, it is stated that in the

SMK curriculum there are 40% theory and 60% practice. For that condition, it is good to implement the dual system. This level refers to the dual system education pattern, because it is suitable with it. This pattern is with the aim of producing graduates who master the knowledge, attitudes, and work skills that are in accordance with the field of expertise of interest and are dynamic in accordance with the needs of the times and demands for global competition. The relevance of SMK to the needs of the World of Work and Industry (DUDI). Vocational development with a national perspective for Vocational High Schools is balance with the competencies to support the business world and industry. In vocational field in emphasizing on the industry needs competencies practically [6], [4], [24]. For example, the need for experts in the fields of computers and pharmacy will continue to grow in the future, so SMKs with areas of expertise like this are the priority to be developed.

Students in SMK in addition to carrying out their duties as participants in the PSG (Dual System Education) for preparation in the field of work, students also get expertise certification. This skill certification is issued by a school with a DUDI recommendation (World of Work and Industry). To bridge the gap between the skills of vocational students as prospective workers with the expectations of business and industry. [20] With this certification, students are able to get a job according to the competencies possessed by each individual. Based on these competencies, SMK graduates are not difficult to penetrate the world of work. The world of work that refers to vocational competence is more applying the conditions of society 4.0. It is referring to society in the 4.0 era with the demands of all of that based on the need for internet-based and computerized industrial technology, graduates' work will be smoother with the skills they have. At this level, the previous students were capitalized with hard skills and soft skills.

The soft skills, in the field of adaptive and normative subjects well planned in classroom learning, even in integrating adaptive lessons with practical lessons. The integration of lessons in SMK is in the subject of creative products and entrepreneurship (PKK). Creative Products and Entrepreneurship or PKK is a subject consisting of theory and practice. Theoretic material is delivered in a conventional manner where the teacher acts as the center of learning, while the student practice class is required to be able to operate the applications used for PKK. PKK subjects are productive subjects in Vocational High Schools, so the school or in this case subject matter teachers must

strive to provide teaching materials or learning resources for students in learning [18].

At creative products and entrepreneurship (PKK) lessons, lessons begin with theory and end with practice in school workshops. In its implementation, the PKK lesson theory, concepts and theories are carried out in an order or procedure that is in accordance with the planning in the lesson plan. In addition to the theory that is taught, character building is taught in an integrated manner in character development that is able to encourage students to become better socially and also a good attitude. [8] the presence of this character education is to improve and reorganize the character of Indonesian society, which aims to make people have noble character. The concept of character cannot be separated from eastern culture which is full of polite customs that are firmly rooted in the culture of the Indonesian people. The culture is not only shown in attitude but morally becomes the foundation and spearhead of the character of society.

The application of character becomes a reflection of culture that must be shown in school but outside of school as well. Theory and practice are implemented at the time of teaching and learning process at school. In the classroom is shown by the attitude of collaboration and mutual respect with tolerance with a zero limit. This condition shows that polite actions are part of an integrated character lesson. Such a good and commendable attitude does not reduce creativity and innovation as well as high-level thinking which is full of challenges and needs to be achieved with outcomes that are able to encourage student competence.

In the implementation of HOTS, is also implemented at school in condition by learning or doing whatever includes as activities. HOTS itself according to [12][11] "Higher order thinking (HOTS) is thinking on a level that is higher than memorizing facts or telling something back to someone exactly the way it was told to you.". According to HOTS, learning is directed at students to think with a high capacity so that students are more ready to accept conditions with everything that is challenging. The creation of these challenging conditions is not only implemented during learning but also outside the curriculum. At the extra curriculum level, students are able to implement problems outside of school that must be resolved. The competence of students is present to solve problems with the provision of creativity and innovation possessed by students. With this, students filter their abilities by collaborating with friends [24].



Cooperation or collaboration between friends is further facilitated by the presence of high-capacity technology so that it can be expected to be able to solve problems that arise. All activities of students who are familiar with the virtual world make the competence of students better because of this life habit, a habitual position that must be lived unavoidably must change the total habit that must be faced when graduating from school to become part of society in the 4.0 era. A change from comfortable things to manual life will encourage the experimentation of creativity and innovation unconsciously or without coercion. Such conditions are the answer for the 4.0 era ideally to carry out the necessary motivation and skills in an integrated manner. In schools, especially vocational high schools, will automatically be formed because of nature, vocational high schools are more able to adapt to society 4.0. The 4.0 industrial revolution era requires acceleration or strengthening for schools in facing the changes, particularly for vocational high schools to follow the changes in the industry, because it relates to the competencies expected during the learning process [11].

Leading to the community 4.0, many students in vocational high schools (SMK) are already accustomed to a pattern of life that is engineered for computerization, however, there are still many schools that have not been able to provide learning media according to the demands of the times. Besides that not all students are able to implement the conditions that should be or ideally. In some schools, especially schools that are far from the hustle and bustle of urban areas or in small private schools, which receive students based on quotas to fulfill school needs, so they have few students. These unfavorable conditions, with low human resources or even leftovers from favorite schools, will be difficult to collaborate with, both in learning and other tasks other than those related to learning. From that condition, the human resources influences in interaction of learning [17].

The students from this non-favorite school will be difficult to manage or even to cooperate or collaborate with. However, these conditions have gradually changed after the advent of technology-based industries, which are expected to be able to overcome the complexity of the problems that arise around the learning environment. [2] During the beginning of modern technology development in the 21st century, science education and technology has become a developed benchmark of a country. The fast development specifically occurs on technology and globalization.

Technology-based learning patterns are expected to be able to overcome problems that often arise in the learning process in the classroom and outside the classroom.

The problem that often arises with real conditions is the value of learning achievement which tends to decrease, especially during the COVID-19 pandemic. teaching and learning process in on hybrid or blended learnings, half is in meeting directly and half online. One breakthrough in the use of technology in the world of education is the implementation of hybrid learning This is to combine the process of delivering learning content via online, offline, mobile, with a face-to-face learning and has been applied to various levels of education [25], [9], [10], [14]. The indication is that students tend to prefer to play on cellphones but do not like to study with the help of computerized learning media. In addition to real conditions, there is an attitude of characterless students because there are no teachers who teach and educate, this happens because during the pandemic there is no face-to-face learning. Based on such conditions, at the present time, society has entered the 5.0 era. Currently, it is hoped that students in Vocational High Schools will be able to overcome problems related to learning that are still patterned in stagnant conditions without getting used to the internet or computerization as daily necessities. needs are often engineered to make things easier with the help of technology. [5] The development of technology has a significant impact on the process of information exchange, including in the field of education. This shows that everything can be overcome with the help of technology and with the help of data reservoirs that can be much larger. the capacity to store large data and technological engineering are the hallmarks of the beginning of the 5.0 era.

Era 5.0 synergizes with the real conditions that are present in learning in vocational high schools (SMK). The problems that arise in such situations are the lack of competence, the degradation of character, and the output of graduates is still below the expected ideal standard. graduates who are only measured by the level of cognitive ability will boomerang with degraded morals and character, it is necessary to improve behavior that tends to be related to attitude. Because in the work not only hard skills but soft skills are needed. In the industrial revolution era 4.0, soft skill components that need to be mastered by another SMK graduate; graduates are communicative, collaborative, critical in thinking, creative, ability management, emotional intelligence, services, negotiation skills, and cognitive flexibility. [11]. Learning patterns that are still struggling with theory

are still outside the box so that learning patterns tend to stagnate and even only pursue cognitive achievements by putting aside attitudes and skills. To overcome this, teachers especially in Vocational High Schools need to adapt to the vocational environment. The lack of competence is simply that the teacher is less able to give hope according to real conditions in the field, but sometimes the students themselves are trying to be able to do it with automation and computerization. Students are able to download and upload the required materials according to conditions in the field. The availability of ICT device has not been utilized by teacher optimally. It can be associated with the perception of the teacher and the readiness to use technology in the classroom. student and teacher having a good perception on using technology in class will potentially optimize the instructional media [23], [7][13]

With this assistance, such conditions will increase students' learning motivation when achieving maximum results. In addition, students do not have to use flash or computers to store large data. students only need a cell phone that is relatively small and portable so it is practical to carry anywhere, just click one button to do that. in other fields, there are emerging competencies or present are engineering something to design something that is new. such as learning media that are in accordance with the needs and demands of the times based on the abilities of the students themselves. Considering such conditions, it is appropriate that the era of digitalization, computerization, and automation are things that cannot be separated from everyday life. Related to these conditions, what are the steps of education providers to prepare and deal with these problems wisely without leaving the culture of the local community.

## **Discussion**

In learning during this covid 19 pandemic, teachers are prepared to be able to carry out both hybrid and blended learning. [16] process of teaching and learning with these ways is expected to be able to accommodate the needs of students. The effectiveness of online learning is supported by poor or good network connections. The teacher's role in leading the class is essential to run education and teaching online as effectively as the traditional classroom [17]. The needs of students become the main part in difficult times like this. On the other hand the learning process must run but the conditions do not allow it to become a challenge in itself.

Learning patterns by integrating HOTS with 4 C coverage are able to adapt to conditions in the 5.0 era and curriculum 2013. [24] One of the focuses of implementing the 2013 curriculum is to realize 21st century learning, namely 4C (critical thinking, creativity, collaboration and communication). In this era, all human needs will be controlled by computer-based technology. In addition, teacher competence will be accompanied by technological engineering that is able to give hope and contribute to the running of life in this new normal era.

In PKK lessons, students are able to become part of the 5.0 era society. as a logical consequence, students are able to apply practice by integrating theory with the help of engineering technology. Automation in all lines of work and tasks is easier to implement.

The product results listed above are proven to be easier to achieve with the role of device automation both in terms of design and getting the output. the process of making the beginning to the end run smoothly cannot be separated from the role of students being able to make era 5.0 an inseparable part of learning in schools, especially in vocational high schools. evidence of learning success is exposed in the learning process in creative product and entrepreneurship. on the results of PKK learning, students are able to make products as part of the process that occurs during in class and outside the classroom. on creative and entrepreneurial products that are driven by theory and integrated with practice to produce outputs that can become ready-to-use products. For example the product is exposed as below;



**Figure 1. Vocational High School Students' work**

The product results listed above are proven to be easier to achieve with the role of device automation both in terms of design and getting the output. the process of making the beginning to the end run smoothly cannot be separated from the role of students being able to make era 5.0 an inseparable part of learning in schools, especially in vocational high schools. evidence of learning success is exposed in the learning process in creative product and entrepreneurship lesson. Entrepreneur is suitable with implementasition of curriculum 2013 in Vocational High School (SMK). The beginning of 2013/2014 school year, Curriculum 2013 is applied gradually to all levels of education in Indonesia, including SMK [26], [19]. On the results of PKK learning, students are able to make products as part of the process that occurs during in class and outside the classroom. On creative and entrepreneurial products that are driven by theory and integrated with practice to produce outputs that can become ready-to-use products. for example the product is exposed as below.



**Figure 2. Creative Product Development of GO-JEK Company**

Gojek as one of the online transportation services, which initially only provided public transportation transportation services with motorbikes, has now developed its products into 12 service products [22]. The products shows that the use of technology and engineering technology is very essential besides as a companion to carry out daily life with the advent of the 5.0 era. The presence of this era helped create opportunities to get things faster and cheaper without using humans as part of getting the job done. Completion of work in the form of automation and computerization has been carried out in vocational high schools in the hope that getting a job has become an unavoidable part of modernization and progress.

The use of technology and engineering technology is nothing but a companion to carry out daily life. with the advent of the 5.0 era. [3] Blended learning is one of the learning solutions in the 5.0 revolution era. According to experts, Blended learning is a combination of online-based learning and face-to-face learning in class. Is a combination of physical learning in the classroom with a virtual environment. The presence of this era helped create opportunities to get things faster and cheaper without using humans as part of getting the job done. completion of work in the form of automation and computerization has been carried out in vocational high schools in the hope that getting a job has become an unavoidable part of modernization and progress.

### **Conclusion**

The use of technology and engineering technology is nothing but a companion to carry out daily life. with the advent of the 5.0 era. The presence of this era helped create opportunities to get things faster and cheaper without using humans as part of getting the job done. completion of work in the form of automation and computerization has been carried out in vocational high schools in the hope that getting a job has become an unavoidable part of modernization and progress.

The presence of the 5.0 era, lessons in Vocational High Schools are easier to follow the 2013 curriculum. This curriculum approach uses a scientific approach which is a scientific framework for learning that is applied to the 2013 Curriculum. The scientific approach adapts scientific steps to science. This approach is also very suitable for automation conditions that require students to be more active in getting something new and implementing it in everyday life. coercion that is already ideal with vocational values which has the aim of accommodating the need for a more organized and more stable job.

### **References**

- [1] A. Prianto, Winardi, & U. N. Qomariyah. The Effect of the Implementation of Teaching Factory and Its Learning Involvement toward Work Readiness of Vocational School Graduates. *International Journal of Instruction*. Vol. 14, No.1. pp. 283-302. 2021.
- [2] A. Widayoko, P. S. Femilia, & A. D. Lesmono. Description of Students' Scientific Literacy Competencies on the Scientific Issue

- of Flat Earth Theory. *Anatolian Journal of Education*. Vol. 4, No.2 pp. 31-38. 2019.
- [3] Arjunaita. Pendidikan di Era Revolusi Industri 5.0. PROSIDING SEMINAR NASIONAL PENDIDIKAN PROGRAM PASCASARJANA UNIVERSITAS PGRI PALEMBANG 10 JANUARI 2020.
- [4] C. L. Chiang. and H. Lee. The Effect of Project-Based Learning on Learning Motivation and Problem-Solving Ability of Vocational High School Students. *International Journal of Information and Education Technology*, 6(9), 709–712. 2016.
- [5] D. Hedihsah & Herman Dwi Surjono. Building Motivation and Improving Learning Outcomes with Android-Based Physics Books: Education 4.0. *Anatolian Journal of Education*. Vol.4, No.2. pp. 1-10. 2019.
- [6] D. A. Sudjimat, A. Nyoto, and Maftuchin Romlie. Implementation of Project-Based Learning Model and Workforce Character Development for the 21st Century in Vocational High School. *International Journal of Instruction*. Vol.14, No.1. pp. 181-198. 2021
- [7] H. M., Asrowi, & Sunardi. Students' Access to and Perception of Using Mobile Technologies in the Classroom: The Potential and Challenges of Implementing Mobile Learning. *Journal of Education and Learning*, 12(4), 644-650. 2018.
- [8] H. Fajrussalam, A. S. Mansyur, & Q. Y. Zaqiah. Gaining Education Character Based on Cultural Sundanese Values: The Innovation of Islamic Education Curriculum in Facing Era Society 5.0. *Jurnal Iqra*. Vol. 5, No. 1. 2020
- [9] H. Hsamah,. Blended Project Based Learning: Metacognitive Awareness of Biology Education New Students. *Journal of Education and Learning*, 9(4), pp. 274–281. 2015.
- [10] H. Husamah. Thinking Skills for Environmental Sustainability Perspective of New Students of Biology Education Department through Blended Project Based Learning Model. *Jurnal Pendidikan IPA Indonesia*, 4(2), pp. 110–119. 2015.
- [11] I. M. Sudana, D. Apriyani, & S. urmasitah. Revitalization of Vocational High School Roadmap to Encounter the 4.0 Industrial Revolution. *The Journal of Social Sciences Research*. Vol. 5, Issue. 2, pp: 338-342, 2019
- [12] J. M. Monari. Higher Order Questions for Higher Order Thinking Skills. *International Journal of Education and Research*. Vol. 8 No. 9. 2020.

- [13] Kaur, S. HRM in 21 st Century: Challenges of future. *International Journal of Emerging Research in Management & Technology*, 9359 (26), 2278–9359. 2013.
- [14] N. Napier. P., Dekhane, S., & Smith, S. Transitioning to Blended Learning: Understanding Student and Faculty Perceptions. *Journal of Asynchronous Learning Network*, 15(1), 20–32. 2011.
- [15] R. Sefriani, I. Wijaya, Menrisal, & M. Dewi. Testing of The Validity of Interactive Learning Module on Creative and Entrepreneurs Learning Products. *Journal of Educational Science and Technology*. Vol 6, No 1, pp 73-78. 2020.
- [16] R. R. Fransiska Sinaga, & R. Pustika. Exploring Students' Attitude towards English Online Learning Using Moodle during Covid-19 Pandemic at AMK Yadika Bandar Lampung. *Journal of English Language Teaching and Learning (JELTL) Language Teaching and Learning (JELTL) Vol. 2, No. 1, , pp 8-15. 2021*
- [17] Sari, F. M. Patterns of Teaching-Learning Interaction in the EFL Classroom. *Teknosastik: Jurnal Bahasa dan Sastra*, 16(2), 41-48. 2018.
- [18] Sefriani, Rini. Wijaya, I. Interactive Multimedia Learning Module Based On Adobe Director On Operation System Course On Vocational High School. *INTECOMS*, 1(1). 2018.
- [19] Sudjimat. *Perencanaan Pembelajaran Kejuruan: Planning of Vocational Learning*. Malang: UM Press. 2014.
- [20] S. Patmanthara and W.N. Hidayat. Improving Vocational High School Students Digital Literacy Skill through Blended Learning Model. *Journal of Physics. Conf. Series 1028 (2018) 012076* doi :10.1088/1742-6596/1028/1/012076
- [21] Thomas, A., & Thorne, G. Higher Order Thinking. *Reading Rockets*. 2009. <https://www.readingrockets.org/article/higher-order-thinking>
- [22] T. Martono, *et. al*. Model Pembelajaran Untuk SMK Program Keahlian Tata Boga dalam Mengembangkan Ekonomi Kreatif. Kementerian Pendidikan dan Kebudayaan Direktorat Jenderal Pendidikan Dasar dan Menengah. Direktorat Pembinaan Sekolah Menengah Kejuruan. 2016.
- [23] Y. D. Puspitarini, & M. Hanif. Using Learning Media to Increase Learning Motivation in Elementary School. *Anatolian Journal of Education*. Vol.4, No.2. pp. 53-60. 2019
- [24] Y. D. Anggreni, Festiyed, & Asrizal. Meta-Analisis Pengaruh Model Pembelajaran Project Based Learning terhadap Kemampuan



- Berpikir Kritis Peserta Didik SMA. *Pillar of Physics Education*, Vol 12. No 4, pp 881-888. 2019.
- [25] Yudiono, Pramono, & Basyirun. The Hypothetic Model of Integrated Production-Based Learning with the 21st Century Learning Skills in Mechanical Engineering. *Jurnal Pendidikan Teknologi dan Kejuruan*, 25(1), 97–102. 2019.
- [26] V. T. Irawan, E. Sutadji & Widiyanti. Blended Learning Based on schoology: Effort of Improvement Learning Outcome and Practicum Chance in Vocational High School. *Cogent Education* 4: 1282031. 2017.

# The contribution of science in building society 5.0

Siti Patonah<sup>104</sup>

## Introduction

Recently, the world has entered the industrial era 4.0, which is characterized by the rapid development of science and information technology. Every nation is competing to encourage its people to master the various skills needed in this 21<sup>st</sup> century. Some skills are required, including critical thinking skills, effective communication, high productivity, and digital literacy. Various breakthroughs and innovations in learning were made so that everyone can successfully adapt to and develop in the era of rapid progress in all fields. Consequently, there is a lack of direct communication between individuals, a lack of manners, and an increased sense of egocentricity. With the advancement of technology, individuals are expected to be able to prepare themselves as part of society 5.0.

Society 5.0 is supported by an integrated system between the real world and the virtual world, eliminates the gap among humans, solves social problems, and is human-centered [1]. Individuals are expected to integrate their knowledge with a variety of knowledge to solve problems in everyday life. Currently, it is not enough to study only one discipline [2]. Learning that can integrate science, technology, engineering, and mathematics is a trend promoted by every country [3], [4]. In this case, science is the key, but it is the teacher's understanding of the nature of science that can lead students to society 5.0. This is because, by understanding the nature of science, teachers teach not only a collection of scientific products but also the process and attitude aspects. Thus, science should be taught in its entirety as it is [5], [6].

All scientific works and attitudes can build society 5.0. To do so, teachers must integrate science processes and products in learning. However, some research shows that teachers' understanding of the nature of science is still low [7]–[9]. Various attitudes as science products such as honesty, thoroughness, curiosity, critical thinking, perseverance, and open mind, as well as the particular attitudes developed to build society 5.0 [10]. Based on the description above, science may contribute to facing the industrial era 4.0 and welcoming society 5.0. However, due to the minimal ability of

---

<sup>104</sup> Universitas PGRI Semarang, [sitifatonah@upgris.ac.id](mailto:sitifatonah@upgris.ac.id)

the teacher in understanding and implementing the nature of science, the author will explain the contribution of science in building society 5.0

## **Discussion**

Industrial era 4.0 started in 1784 as the industrial era 1.0, which was marked using steam engines in running the industry. Humans began to build industries to meet their growing and varied needs. The use of steam engines has increased the productivity of human needs. One century later in 1870, the era of revolution 2.0 started. This era was marked by the production machines using fuel oil. In 1969, the industrial revolution 3.0 began. It was characterized using information technology and automation. Meanwhile, in 2011, industrial era 4.0 had been marked by machines that were coordinated with the internet. The internet was not only a tool but also a coordinated system with a combination of software, sensors, processors, and communication technology to enter information and ultimately add value to the manufacturing process [11].

The existence of The Internet of Things (IoT), Cybersecurity, The Cloud, and Big data analytics is an endless discussion to show the existence of the industrial era 4.0. The use of these four technologies allows for centralized control through computing devices, increased communication security, and improved technology performance due to deployment through the cloud. It also enables comprehensive data collection and evaluation from multiple sources and customers to support direct decision making, optimize production quality, save energy, and improve productivity. In this case, community activities are centered on humans which can balance economic progress with solving social problems using a system that integrates the virtual and physical worlds, known as society 5.0, which was initiated by the Japanese government in 2016 [11]. As the industrial era passed 4 quarters, the society era passed 5 quarters, namely societies 1.0, 2.0, 3.0, 4.0, and 5.0.

In the era of society 1.0, there was a harmonious relationship between humans and nature because humans only gathered and hunted. In the era of society 2.0, they formed groups based on agricultural cultivation, organizational improvement, and development. Society 3.0 is a society that promotes industrialization through the industrial revolution 1.0, starting from the end of the 18th century. Society 4.0 is an information society that realizes increasing added value by connecting intangible assets as information networks,

starting from the mid-20th century. In this stage, society 5.0 is an information society built on society 4.0, which aims for a more prosperous society. Thus, it appears that the industrial era 4.0 and society 5.0 are an era of transformation of analog technology into digital. The technology in society 5.0 is a continuation of industrial technology 4.0. Digital transformation has changed the way people live and industries run. Each subject is directed to support the success of the industrial era 4.0 and society 5.0, including science subjects.

Natural science is a subject that has an orientation to develop a scientific attitude. From science learning, it is expected that students can learn about themselves and the natural environment, and the results can be applied in everyday life [12], [13]. The essence of science is to present several disciplines of science, scientific knowledge, or nature of science (NOS) representing some interdisciplinary content from the science curriculum about what science is and how science works as a way to know and explain the natural world, which has been elaborated from an interdisciplinary perspective [14]. Science is essentially an integration between products, processes, and attitudes [5], [10], [15], [16]. The product of the thoughts and findings of experts. The products of thoughts and findings of experts include facts, concepts, generalizations, laws, and theories. Products of scientific knowledge have the following characteristics: tentative, subjective, and based on empirical data. A theory can stay true until another theory is found that invalidates it.

The discovery of a new theory does not mean the original theory is a failure but becomes a link for the emergence of subsequent theories. The object of scientific knowledge is objective nature (as it is), but the discoverer's interpretation can create subjectivity because of the inventor's background and the socio-cultural experience experienced. Scientific knowledge products are based on empirical evidence preceded by a hypothesis. Hypotheses that are per empirical data can then be verified into theories; on the contrary, hypotheses can be rejected when they do not match the empirical data. This is what distinguishes science from other sciences, where science pays attention to evidence and is willing to change theories based on existing evidence [17].

In addition, the existing theory is not only based on strong empirical evidence, but it can also predict the wider world to ensure that the theory can survive the development of new evidence. As a science, science has a method of developing knowledge known as the scientific method. The scientific method consists of formulating

research questions, planning investigations, carrying out investigations, analyzing data, drawing conclusions, and communicating results [10]. Based on the stages of the scientific method, a scientific attitude arises from the application of each step of the scientific method. To be able to carry out the scientific method, every individual must have skills known as science process skills. Included in the science process skills are observing, measuring, classifying, predicting, inferring, communicating, interpreting data, formulating hypotheses, identifying variables, defining operations, conducting experiments, and developing models [16]. Numbers 1 to 6 are included in basic process skills while numbers 7 to 12 are included as integrated process skills. By understanding how scientific products are produced through the scientific method, an inherent attitude emerges, known as a scientific attitude.

Scientific attitudes have proved to have implications for the attitudes needed to face the 21st century, both the industrial era 4.0 and society 5.0 [18], [19]. People with a good scientific attitude are humble, earnest, unyielding, open-minded, intellectually honest, curious, and self-critical [10], [17]. Children have a high curiosity about the natural environment and always want to investigate it [20]. Learning that can provide a good basis for children's potential to fulfill their curiosity becomes a meaningful provision in the future. The scientific method that is done properly can result in the right scientific attitude that is useful in everyday life. Therefore, it is not enough for a person to only master science textbooks/science knowledge when he does not apply the process and train his scientific attitude. Science as a product, process, and attitude is a unity that cannot be separated from one another. One of the learning approaches that can optimize science according to its essence is the STEM (Science, Technology, Engineering, Mathematics) approach.

The world is in a new phase of technological and industrial development, which plays an important role in social and economic transformation. Countries around the world are actively promoting the integration of disciplines such as science, technology, engineering, mathematics, and other subjects [21], [22] to prepare for future careers [4], [23]. Science is a part of our lives, and our lives are a part of learning science. Science learning ideally not only studies products but also pays attention to aspects of the process, attitude, and technology so that students can understand science in its entirety following the nature of science; therefore, in science learning, the teacher must prepare a learning experience for students that

emphasizes aspects of products, processes, attitudes, and their relationship to everyday life [5]. Science learning that is integrated with other subjects can improve scientific literacy. All other subjects can be integrated with science [24].

The concept of integrating science with other fields is a hallmark of STEM learning which was initiated in 1986 and began to develop in 1990 [20]. STEM integration is the choice of learning design that is most relevant to the demands of the times and is applied at all levels of education [25]. Through STEM, students get 3 specific learning areas, namely: STEM content learning, engagement, persistence, and team development and work [26]. STEM programs encourage and support students to become critical thinkers, problem solvers, and creative individuals. Schools view and use STEM education as a tool to prepare students for college and future careers. Various kinds of skills that students will need in the future can be developed in the current STEM education program. STEM education has proven to be a very meaningful experience for students [4]. The principles of STEM learning refer to their respective components as contained in the National Research Council (NRC), namely:

1. Science acts as the information underlying engineering design.
2. Technology was created to satisfy human needs for many things.
3. Engineering utilizes the concepts of science and technology.
4. Mathematics is used in science, technology, and engineering.

Each engagement is carried out with 3 types of approaches, namely the silo approach (separate), the embedded approach, and the integrated approach. From this type of approach, an integrated approach is the best approach. In designing technology, 8 stages need to be considered according to Davis [20], namely:

1. Asking questions (for science) and defining the problem (for engineering)
2. Developing and using models
3. Planning and carrying out the investigation
4. Analyzing and interpreting data
5. Using mathematical and computational thinking
6. Building explanations (for science) and designing solutions (for engineering)
7. Engaging in arguments from evidence
8. Obtaining, evaluating, and communicating information

Based on these 8 steps, individual attitudes can be generated to support the readiness of industry 4.0 and society 5.0. Among them,

the STEM approach can increase motivation [27], prepare for future careers [3], [4], improve critical thinking skills [28], and improve teacher readiness to face knowledge fragmentation [24].

## Conclusion

The nature of science is an inseparable unity between products, processes, and scientific attitudes. A person who learns science only masters the product; it cannot be said that he has mastered real science. The application of the nature of science in learning can foster the attitudes and life skills needed in dealing with industry 4.0 and society 5.0. Through science learning, the preparation of human resources who are ready to face future challenges can be realized.

## References

- [1] S. Suyidno, A. S. M, M. Arifuddin, M. Misbah, and J. Siswanto, "Menyiapkan Peserta Didik untuk Masyarakat 5.0 melalui Creative Responsibility Based Learning," *J. Pendidik. Fis. dan Keilmuan*, vol. 6, no. 1, p. 25, 2020, doi: 10.25273/jpfk.v6i1.6041.
- [2] C. Faikhanta, "Pre-Service Science Teachers' Views of the Nature of STEM," *Sci. Educ. Int.*, vol. 31, no. 4, pp. 356–366, 2020, doi: 10.33828/sei.v31.i4.4.
- [3] K. Lesseig, J. Firestone, J. Morrison, D. Slavitt, and T. Holmlund, "An Analysis of Cultural Influences on STEM Schools: Similarities and Differences Across K-12 Contexts," *Int. J. Sci. Math. Educ.*, vol. 17, no. 3, pp. 449–466, Mar. 2019, doi: 10.1007/S10763-017-9875-6.
- [4] S. J. Seage and M. Türegün, "The effects of blended learning on STEM achievement of elementary school students," *Int. J. Res. Educ. Sci.*, vol. 6, no. 1, pp. 133–140, Dec. 2020, doi: 10.46328/IJRES.V6i1.728.
- [5] N. Sari, M. Syarif Sumantri, and I. G Bachtiar, "The Development of Science Teaching Materials Based on STEM to Increase Science Literacy Ability of Elementary School Students," *Int. J. Adv. Sci. Res. Eng.*, vol. 4, no. 7, pp. 161–168, Jul. 2018, doi: 10.31695/IJASRE.2018.32808.
- [6] C. C. Lu, J. C. Hong, F. F. Chen, and S. Y. Ma, "Elementary school students learn arduino programming to assemble sensory-controlled works," *Int. J. Inf. Educ. Technol.*, vol. 10, no. 4, pp. 265–270, Apr. 2020, doi: 10.18178/IJIE.T.2020.10.4.1374.
- [7] S. Wilson and N. N. Heidi Schweingruber, *Science Teachers'*

- Learning*. The National Academies Press, 2016.
- [8] Y. K. Adi and A. Widodo, "PEMAHAMAN HAKIKAT SAINS PADA GURU DAN SISWA SEKOLAH DASAR," *Edukasi J. Pendidik*, vol. 10, no. 1, pp. 55–72, 2018.
- [9] S. Aisah, "Analisis Pemahaman Guru Tentang Konsep Hakikat Ipa Dan Pengaruhnya Terhadap Sikap Ilmiah Siswa Sekolah Dasar Di Depok," *Al-Mubin; Islamic Scientific Journal*, vol. 3, no. 1. pp. 16–26, 2020, doi: 10.51192/almubin.v3i1.66.
- [10] A. Widodo, *PEMBELAJARAN ILMU PENGETAHUAN ALAM Dasar-Dasar untuk Praktik*. 2021.
- [11] D. Hendarsyah, "E-Commerce Di Era Industri 4.0 Dan Society 5.0," *IQTISHADUNA J. Ilm. Ekon. Kita*, vol. 8, no. 2, pp. 171–184, 2019, doi: 10.46367/iptishaduna.v8i2.170.
- [12] Sahyar and F. Hastini, "The Effect of Scientific Inquiry Learning Model Based on Conceptual Change on Physics Cognitive Competence and Science Process Skill ( SPS ) of Students at Senior High School," *J. Educ. Pract.*, vol. 8, no. 5, pp. 120–126, 2017.
- [13] R. Astuti, N. M. Nisak, A. Nadlif, and A. Wulan Hajjatul Zamzania, "Animated video as a Media for Learning Science in Elementary School," *J. Phys. Conf. Ser.*, vol. 1779, no. 1, Feb. 2021, doi: 10.1088/1742-6596/1779/1/012051.
- [14] M. A. Manassero-Mas and Á. Vázquez-Alonso, "Science teacher education on nature of science through explicit and reflective curriculum development," *Asia-Pacific Forum Sci. Learn. Teach.*, vol. 20, no. 2, pp. 1–28, 2021.
- [15] U. Duruk, A. Akgün, C. Doğan, and F. Gülsuyu, "Examining the Learning Outcomes Included in the Turkish Science Curriculum in Terms of Science Process Skills : A Document Analysis with Standards-Based Assessment," *Int. J. Environ. Sci. Educ.*, vol. 12, no. 2, pp. 117–142, 2017.
- [16] E. S. Siti Patonah, Duwi Nuvitali, "Pembelajaran Inquiry dan Keterampilan Proses Sains dalam Implementasi Kurikulum IPA di SMP," *Semnas Sains Entrepreneursh. IV*, pp. 183–193, 2017.
- [17] Lee McIntyre, *The Scientific Attitude Defending Science from Denial, Fraud, and Pseudoscience*, vol. 5, no. 2. The MIT Press Cambridge, Massachusetts London, England, 2019.
- [18] E. Eppler, L. Filgueira, J. Meyer, S. Serowy, K. Link, and B. Pauk, "Enhancing Scientific Communication Skills : a Real-World Simulation in a Tertiary-Level Life Science Class Using E-Learning Technology in Biomedical Literature Perception ,



- Reflective Review Writing on a Clinical Issue , and Self and Peer Assessments," 2018.
- [19] S. P. Chien and H. K. Wu, "Examining influences of science teachers' practices and beliefs about technology-based assessment on students' performances: A hierarchical linear modeling approach," *Comput. Educ.*, vol. 157, no. April, p. 103986, 2020, doi: 10.1016/j.compedu.2020.103986.
- [20] Elizabeth A. Davis and Amy Stephens, *Science and Engineering in Preschool Through Elementary Grades*. 2021.
- [21] S. Hanif, A. F. C. Wijaya, and N. Winarno, "Enhancing Students' Creativity through STEM Project-Based Learning," *J. Sci. Learn.*, vol. 2, no. 2, p. 50, 2019, doi: 10.17509/jsl.v2i2.13271.
- [22] W. Pei, "Curriculum Reform of Science in Elementary Schools in China," *Beijing Int. Rev. Educ.*, vol. 1, no. 2–3, pp. 573–578, Jul. 2019, doi: 10.1163/25902539-00102007.
- [23] A. L. Glaze-Crampes, "Leveraging communities of practice as professional learning communities in science, technology, engineering, math (STEM) education," *Educ. Sci.*, vol. 10, no. 8, pp. 1–8, 2020, doi: 10.3390/educsci10080190.
- [24] K. Karampelas, "Cross curricular science in elementary schools in Greece - The curriculum factor," *Int. J. Learn. Teach. Educ. Res.*, vol. 18, no. 7, pp. 16–32, 2019, doi: 10.26803/IJLTER.18.7.2.
- [25] S. Apriliya, D. Sunendar, Y. Mulyati, and S. Sumiyadi, "Holistic and attractive: Children's story book with STEM for elementary school," *J. Phys. Conf. Ser.*, vol. 1318, no. 1, Oct. 2019, doi: 10.1088/1742-6596/1318/1/012071.
- [26] Y. H. Ching, D. Yang, S. Wang, Y. Baek, S. Swanson, and B. Chittoori, "Elementary School Student Development of STEM Attitudes and Perceived Learning in a STEM Integrated Robotics Curriculum," *TechTrends*, vol. 63, no. 5, pp. 590–601, Sep. 2019, doi: 10.1007/S11528-019-00388-0.
- [27] J. Vinni-Laakso, J. Guo, K. Juuti, A. Loukomies, J. Lavonen, and K. Salmela-Aro, "The relations of science task values, self-concept of ability, and stem aspirations among finnish students from first to second grade," *Front. Psychol.*, vol. 10, no. JUL, 2019, doi: 10.3389/FPSYG.2019.01449.
- [28] Y. Elfrida Yanty Siregar, R. Rachmadtullah, N. Pohan, Rasmitadila, and M. S. Zulela, "The impacts of science, technology, engineering, and mathematics (STEM) on critical thinking in elementary school," *J. Phys. Conf. Ser.*, vol. 1175, no. 1, Jun. 2019, doi: 10.1088/1742-6596/1175/1/012156.

# **Building Student Character in Writing Poetry Based On Makassar Local Wisdom in The Era of Society 5.0**

Siti Suwadah Rimang<sup>105</sup>

## **Introduction**

Strengthening character must be carried out in line with the era of the Industrial Revolution 4.0, the Revolution of Society 5.0, and "Freedom of Learning". National character education is rooted in national culture which means rooted in local culture. It is the noble values of local culture that are close to students and can be instilled through informal (family), formal, and non-formal education. The nation's character is built through 4 things rooted in the values of Makassar local wisdom, namely siri', pacce, sipakatu, and caradde. These four things produce the basic character of being brave, humane, caring, and intelligent which is then developed into other characters. Through literature study and descriptive analysis, the development and strengthening of the nation's character can be done with Makassar's language, literature, arts and culture.

Makassar cultural arts, such as Kelong, anngaru, and traditional expressions contain values that strengthen the nation's character, such as being religious, responsible, loving the homeland, national spirit, communicative, socially caring, democratic, tolerant, hard working, creative, disciplined, independent, honest, and others. The problem of character education in Indonesia so far concerns moral education and in its application it forms too much of a certain direction of learning so as to forget other subjects, in learning it also forms a curriculum angle which is summarized in a ready-to-use form. -presenting menu formulas without looking at the results of the process carried out.

In line with this, said that character education can also be interpreted as a process of giving guidance to students to become fully human beings with character with dimensions of heart, mind, body, taste and intention. - character values to school members which include components of knowledge, awareness, or willingness, and actions to implement these values both towards God, oneself, others, the environment, and the nation. [1]

---

<sup>105</sup> [sitisuwadahrimang@unismuh.ac.id](mailto:sitisuwadahrimang@unismuh.ac.id)

So far, the education process in Indonesia which is oriented towards the formation of individual characters cannot be concluded because the education process in Indonesia is also abroad with certain benchmarks, especially logic-mathematics as the main benchmark that places a person as first class. inhabitant. In the process, character education that has an impact on morals is ruled out and as a result there are many real failures in the dimensions of individual character formation, for example Indonesia is famous in the world arena for bad stories such as corruption with soft morality.

As we know that the process of globalization will continuously have an impact on changing the character of the Indonesian Society. Character education will cause a moral crisis that has an impact on negative behavior in the Society, such as promiscuity, lack of illegal drugs, theft, violence against students, and others. To improve the character of students in terms of writing free poetry based on Makassar local wisdom, of course, it is necessary to introduce culture to students first by paying attention to technological developments 5.0. so that students can adjust to current conditions. [2]

Adaptation of technology made by students is a necessity. With adaptation, students will get more *opportunities* even through administrative *borders*. Students who do not adapt will be left out by the times. In the *closing statement*, it appears that *Society 5.0* is not something to be afraid of, instead the younger generation should take this as a momentum to continue improvising, innovating, and adapting technology. Learning for students is expected to have a positive impact on the surrounding environment because students are the millennial generation who must improve their abilities in life.

The character education that has been planned must of course be implemented. Without the application of character education values carried out by teachers, this will only be a futile discourse. For this reason, character education must be applied starting from the learning activities carried out by the teacher in the classroom. One of them in learning literature is writing poetry. [3] Writing writing is an activity to convey something using language through writing with certain intentions and considerations to achieve something to the reader.

In the world of education, writing will still be valuable, because writing helps someone think more easily. Writing is a very powerful tool in learning which itself plays a very important role in

the world of education. The development of character formation in schools is basically so that students recognize and accept character values as their own and are responsible for the decisions they make through the stages of knowing choices, evaluating choices, making decisions, and then turning a value into self-confidence. [3]

The problem then is first, students are currently less able to use technology in expressing their ideas, secondly students do not know about their culture so it takes a long time to introduce their culture, namely Makassar culture. It is this problem that is discussed on this occasion, so that it can be digested again that the importance of character building in writing poetry without forgetting the local wisdom that students have, in accompanying the 5.0 era.

## **Discussion**

One of the possible alternatives for inculcating character education in students in schools is character education through learning Indonesian. The cultivation of character education can be done in writing poetry based on Makassar local wisdom. Poetry is a work that is full of meaning and valuable life lessons. Learning to write poetry is able to familiarize students with being able to express their ideas, thoughts and feelings through the medium of poetry. The ideas and thoughts of students vary and differ from one another.

Expression of feelings in students can be in the form of love, affection, pleasure, hate, anxiety, and so on. The expression of course occurs because of events experienced by students personally. The events they experience are not only pleasant events, they actually experience unpleasant events. All events that have been experienced by students must have a lesson. The wisdom of this incident can be used as a lesson for the created life. This wisdom can be in the form of poetry. Of course the poem will contain good character values. [4]

Through learning to write poetry, all expressions in students can be directed to good character, so that positive characters can be formed. Besides that, it can also produce a product in the form of a poem that contains a good character as well. If the poem is displayed on a wall magazine, then the teacher has instilled the character values of mutual respect for students. [5]. The values of local wisdom that are polite, friendly, respectful, wise, and religious seem to be eroded and reduced to an instant and modern lifestyle. People are very easy to trigger their emotions, brutal, rude, and vulgar without being able to control their passions, such as the behavior of the demonstrators who burned houses or houses, damaged buildings, and said harsh words,

in demonstrations broadcast on social media, greatly interfere with the coaching that is carried out on students. This phenomenon can be a representation of the weakening of the nation's character which is known to be friendly, polite, noble, and virtuous. [6]

### **The use of technology in writing poetry in the 5.0 era**

In facing the era of society, there are two things that must be done, namely adaptation and competence. Adapting to Society 5.0, we need to know the development of the generation (knowing generation). The term baby boomer in question is the high birth rate of several generations from generation x to generation where there is a transformation of human civilization. To answer the challenges of the Industrial Revolution 4.0 and Society 5.0 in the world of education, 21st century life skills or better known as 4 C (Creativity, Critical Thinking, Communication, Collaboration) are needed. It is hoped that all elements of education can become creative, inspiring and exemplary individuals [7]

It seems that technology and humans cannot be separated in developing knowledge both individually and as a whole. Over time, technology made by humans is growing and even advancing rapidly. One of them is Society 5.0 which was initiated by the Japanese state. The concept of Industrial 4.0 and Society 5.0 resolutions actually don't have much difference, but the Society concept focuses more on the human context as the implementer or controller of technology.

Era Society 5.0 aims to integrate virtual space and physical space. Integration is done to facilitate all human activities. The balance of economic progress with solving social problems by utilizing a system that deeply integrates the two makes things easy, especially job prospects. The IT-based School Literacy Movement (GLS) needs to be activated. Teachers, especially in terms of writing poetry based on local wisdom so that they can build a generation of competence, character, new literacy skills, and high-level thinking skills. Educators are the key in building a dignified Indonesia.

Character education is defined as value education, character education, moral education, character education, which aims to develop the ability of students to make good decisions, maintain what is good, and realize that goodness in everyday life wholeheartedly. That is, character education prioritizes positive things in attitude and action, thus giving birth to a disciplined and responsible generation. In the era of Society 5.0, information will spread rapidly with the mobilization of people and the movement of

technology. students must be responsive, adapt quickly, and as quickly as possible catch up with other countries whose technology and human resources continue to advance. But behind the very rapid technological advances, all elements of education must still uphold the identity of the Indonesian nation.

Character will be formed when the activity is repeated regularly until it becomes a habit, which in the end not only becomes a habit but it has become a character. Character education can be applied to all subjects. In this case, writing poetry that is continuously done will certainly build patient character and be able to spread love to others. As the right skills need to be learned by students, of course this must be honed at all times, this is where character will be formed, with constant habituation that will give birth to characters who are patient, diligent, honest and full of responsibility. It is even more interesting if the poems written by students are poems related to their respective regions.

With the right character, it is hoped that students will become the nation's successors to be able to answer various educational challenges in the era of Society 5.0. Forming a young generation that is creative, innovative, has character, has integrity and upholds tolerance in accordance with the values of the nation as an Indonesian nation by respecting its cultural diversity.

### **Lack of understanding of local wisdom culture for students in the 5.0 era**

In this era of globalization, the existence of local culture faces an alarming situation. Local culture began to erode its existence. This situation is felt by many people, siri' napace is the original culture of the Makassar Society which is a way of life in living life and in speaking, acting and behaving. If the values of local cultural wisdom are not maintained and maintained, it is feared that they will gradually experience a process of extinction due to the influence of globalization. One effort to maintain it is through the use of local culture in the process.[8]

Wisdom comes from the word wise. Arif has two meanings, namely knowing or knowing. The second meaning is clever, clever and wise. (Indonesia Dictionary). The word wise, which if added with the prefix "ke" and the suffix "an" becomes wisdom, means wisdom, intelligence as something that is needed in interacting. Serving people, are people who have the nature of knowledge, namely neutral, honest and have no intermediate interests, but are solely based on cultural

values and truth according to their scope. The word local, which means a place or in a place or in a place where there is growth, there is life, something that may be different from other places or is in a place of value which may apply locally or may also apply universally. Local wisdom is defined as "wisdom in traditional culture" of ethnic groups. Wisdom in a broad sense is not only in the form of cultural norms and values, but also all elements of ideas, including those that have implications for technology, health care, and aesthetics. With this understanding, what is included as the elaboration of "local wisdom" are various patterns of action and the results of material culture. The culture and local wisdom possessed by a society can be explored and mapped as a model in dealing with media exposure. [8]

Every traditional society, which in Indonesian terms means every ethnic group, has a unique way of inheriting cultural values. Society 5.0 is a new life order concept for the public. Through the concept of Society 5.0, Society's life is expected to be more comfortable and sustainable. people will be provided with products and services in the right quantity and time required. [9]

In the era of Society 5.0, students are exposed to technology that allows access in virtual spaces that feel like physical spaces. In Society 5.0, AI technology is based on big data and robots can perform or support everyday work. Unlike the 4.0 industrial revolution which is more important in business, but with the technology of the Society 5.0 era, new values will maintain and maintain social relations, age, gender, language and provide better services in human life. The results that character formation in students appears in the habit of writing poetry as evidenced by very satisfying learning outcomes and student behavior can be controlled, this research was conducted in junior high school.

Therefore, to help students increase their confidence, teachers need to assist students in disseminating their work, especially the poetry they write based on their respective local wisdom. The use of technology in disseminating works of poetry, novels, and short stories is certainly highly expected, especially now that technology can be used as a tool in seizing opportunities in promoting social life. It is not impossible that the teaching and learning process can be done anywhere and anytime, whether there is a teacher/teacher or not. All can be anticipated by maintaining patience in completing the tasks given by the teacher.

## Conclusion

Based on the description above, it can be concluded that character can be built through improving students' writing skills by paying attention to their local wisdom, so that students can express their ideas and thoughts well and disseminate them through social media. In this era of society 5.0, students are expected to have 6 Basic Literacy skills (numeric literacy, scientific literacy, information literacy, financial literacy, cultural literacy and citizenship).

Society 5.0 is a concept of Society which is human-centered and technology-based. Not only basic literacy but also other competencies, namely students are able to think critically, reason, be creative, communicate, collaborate and have problem solving skills. And most importantly, have the behavior (character) that reflects the profile of Pancasila students such as curiosity, initiative, perseverance, adaptability to leadership, social and cultural awareness.

## Referensi

- [1] D. I. L. Sekolah, "No Title," vol. 2, no. 1, pp. 340–363, 2018.
- [2] Syarif Beddu, Arifuddin Akil, Wiwik Wahidah Osman, and Baharuddin Hamzah, "Eksplorasi Kearifan Budaya Lokal Sebagai Landasan Perumusan Tatanan Perumahan dan Permukiman Masyarakat Makassar," *Pros. Temul Ilm. IPLB*, pp. 7–12, 2014.
- [3] T. Pratiwi, M. Rohmadi, and A. Anindyarini, "IMPLEMENTASI PENDIDIKAN KARAKTER DALAM PEMBELAJARAN MENULIS PUISI ( STUDI KASUS SISWA KELAS VII SMP NEGERI 16 SURAKARTA ) Tia Pratiwi , Muhammad Rohmadi , Atikah Anindyarini Universitas Sebelas Maret Surakarta Surel : tiapратиwi96@gmail.com Bangsa Indones," *Basastra*, vol. 5, no. 3, pp. 199–206, 2017.
- [4] T. D. Jayanti, "Nilai-Nilai Karakter dalam Proses Pembelajaran Puisi di Kelas VII SMP Negeri 2 Tawangmangu," p. 2, 2016.
- [5] M. D. Rahmayantis, "Pengembangan Bahan Ajar Membaca Indah Puisi Untuk Siswa SMP Kelas VII," *KEMBARA J. Keilmuan Bahasa, Sastra, dan Pengajarannya*, vol. 2, no. 1, pp. 47–56, 2016, [Online]. Available: <http://ejournal.umm.ac.id/index.php/%0Akembara/index>.
- [6] H. Mawarni, S. Suwandi, and S. Supriyadi, "Local Wisdom in Lawas (Poetry) Ponan Party Ceremony Society of Sumbawa Nusa Tenggara Barat," *Int. J. English Lit. Soc. Sci.*, vol. 4, no. 2, 2019, doi: 10.22161/ijels.4.2.8.



- [7] F. Y. Liao, "The relationship between L2 students' writing experiences and their perceived poetry writing ability," *Stud. Second Lang. Learn. Teach.*, vol. 7, no. 4, 2017, doi: 10.14746/ssl.t.2017.7.4.4.
- [8] D. J. Amelia, I. W. P. Utami, and B. Ulum, "Utilization of Audio-Visual Media Based on Local Wisdom As Teaching and Learning Media on Elementary School Education ...," *Widyagogik*, vol. 8, no. 2, 2021.
- [9] G. T. Derana, "Bentuk Marginalisasi Terhadap Perempuan," *J. Keilmuan Bahasa, Sastra, dan Pengajarannya*, vol. 2, no. 2, pp. 166-171, 2016.

# **Early Detection Services Development for The Indonesian Ethnic Group Specified in The Community Era 5.0**

Sri Lestari Utami<sup>106</sup>

## **Introduction**

Various websites that offer DNA testing to predict potential risks and prevent disease early on have been launched. This DNA examination is based on the presence of variants as DNA that is specific and unique to a person. This DNA variant is about 0.5% of the identical 99.5% that a person has when compared to other people. This DNA plays a role in the inheritance of traits from parents to their children, so that variants will be related to several conditions. These conditions can be related to certain health conditions, traits, and ancestral groups.

There are websites that only offer ancestry checks, like 23andme.com and ancestry.com. However, some of them are also used for other purposes, such as paternity tests, disease risk assessments (such as cancer, Alzheimer's, and others), and genetic diseases. Some of them can even be used to examine genetic talent for the type of wine that tends to be liked. There are also websites that offer multiple checks, which are classified because they are basically the same. Several classifications of examinations are available, such as health checks, pharmacy, nutrigenetics, sports, skin other than ancestors. These websites include: [pursuit.unimelb.edu.au](http://pursuit.unimelb.edu.au); [genomicdiagnostic.com.au](http://genomicdiagnostic.com.au); [24genetics.com](http://24genetics.com); [circledna.com](http://circledna.com). There is already a similar website in Indonesia, which is named [dnaku.id](http://dnaku.id). At [dnaku.id](http://dnaku.id), it serves DNA testing related to exercise, diet, health, skin, cancer markers, drug and vascular responses [1]–[6]

Degenerative diseases are diseases that can be detected early based on DNA variants. Among these diseases are hypertension, type 2 diabetes mellitus (T2DM), coronary heart disease, stroke, and osteoporosis. The presence of this DNA variant is a genetic polymorphism. For several years, researchers have studied the relationship between various variations in the human genome and

---

<sup>106</sup> Universitas Wijaya Kusuma Surabaya

certain characteristic phenotypes. The results suggest that the mechanism of this inherited genetic susceptibility condition is defined as the presence of mutations or polymorphisms of one or more genes that influence the phenotype. Analysis of variation in this case is a very popular method, the aim of which is to link certain allele variants with characteristic phenotypes, especially in polygenic (multifactorial and complex) diseases. The interaction between genes and the environment causes multifactorial disease. Phenotypes such as susceptibility to disease, response to drugs, vaccines, chemicals, and pathogens can be affected by polymorphisms or variations in DNA sequences. The frequency of polymorphisms is 1%, which occurs more frequently than mutations. Single nucleotide polymorphism (SNP/SNIP) is the most common type of polymorphism. These SNPs occur when a single base of DNA is changed and occur more frequently in human genetics. Markers in various studies often use a single nucleotide polymorphism [7], [8]

The high prevalence of non-communicable diseases in Indonesia is expected to reduce the proportion of the population aged 50 years and over. As a result, this disease causes the dominant mortality or mortality rate in Indonesia. This indicates a change in disease patterns that are dominated by non-communicable diseases such as diabetes mellitus, heart disease, dyslipidemia, obesity, kidney disease, lung disease, and malignancy. This change in pattern can be caused by changes in the environment, technology, or lifestyle. The 2014 Sample Registration System shows the ten most common diseases. Complications of high blood pressure (hypertension) and diabetes mellitus were included in the percentages of 5.3% and 6.7%, respectively.[9], [10] Among several risk factors for T2DM and hypertension, ethnicity is one of them. This can be seen in the diabetes risk questionnaire launched by the American Diabetes Association on its website, which shows one of the questions is about ethnicity or the various studies on primary hypertension and T2DM that show it. [11]

The country of Indonesia is located in Southeast Asia, with an ethnicity classified as Asian. The Indonesian nation is classified from a different point of view. It will be divided into various kinds of ethnic groups. In the classification based on the "New Classification" in the 2010 census data, there will be more than 1,000 ethnic groups. The ethnic groups that rank fifth largest are Javanese, Sundanese, Batak, other Sulawesi ethnicities, and Madura, with a percentage of 40.22, 15.5, 3.58, 3.22, and 3.03. Meanwhile, if we look at the high-resolution analysis of haplotype diversity, there are differences between East

and West Indonesia. The population history of Indonesia is complex as it is a genetic mix of early Austronesian expansion with the genetic contribution of the Filipino population. Genetic mixing with the local population will form Eastern Indonesia. But Western Indonesians are much more complex because of interactions with Mainland Asians and Austronesian settlers, as well as genetic contacts with South Asians and isolated local groups. [12]–[14]

The results of research on gene polymorphisms in Indonesia may show the same or different results in different ethnic group. The study of IL-6-174 G/C gene polymorphisms showed that the C/C genotype was found in all respondents, postmenopausal women with osteoporosis in the Balinese tribe. Meanwhile, there was a significant difference in the IL-6-572G/C gene polymorphism.[15] Another population study in Jakarta showed that 96 respondents (96%) had the GG genotype, 4 respondents (4%) had the GC genotype, and none had the CC genotype. These results showed that there was no significant relationship between the IL-6-G174C gene polymorphism and postmenopausal women. The population of Jakarta is dominated by the Betawi, or Sundanese [16].

The existence of the above explanation causes the writer to be interested in expressing the idea of the need for "Development of Specific Degenerative Disease Early Detection Services for Indonesian Ethnic People in the Era of Society 5.0". This is due to the development of technological advances that use the internet for everything, as well as "big data" gene polymorphisms for the Indonesian ethnic group in the era of Society 5.0. Research shows that although ethnicity is the same, different ethnic groups will have different gene variations. This specific genetic polymorphism can be used to design biomarkers for early detection, especially for degenerative diseases that are multifactorial. Very early knowledge of the health risks of chronic diseases with high rates of mortality and morbidity would be very useful. Preventive measures can be taken by regulating environmental factors such as lifestyle so that genetic factors are not expressed. Although, in the end, someone with sick parents will get sick too, it is hoped that this disease does not appear at a young age or its severity can be reduced. While the examination at dnaku.id. does not cover all degenerative diseases and has very complicated methods, with the existence of "affordable internet signals and big data", it is hoped that the preparation of "biomarkers" with detection technology that is much simpler, flexible, inexpensive, and can be done anywhere will be carried out.

## **Discussion**

### **Shifting disease trends as a burden in Indonesia**

There are five diseases whose prevalence in Indonesia is included in the top 10 non-communicable diseases, namely hypertension, type 2 diabetes mellitus (T2DM), coronary heart disease, stroke, and osteoporosis. This is based on a shift in global trends in causes of death according to the 2018 Institute for Health Metrics and Evaluation (IHME) Report in the 2017 Global Burden of Disease Study, especially in non-communicable diseases from infectious diseases. Among the non-communicable diseases are ischemic heart disease and stroke, in addition to other diseases. The report stated that there was a shift in the ranking of ischemic heart disease and stroke in comparison between 1990 and 2017.

The ranking of ischemic heart disease rose from rank 4 to rank 1. Stroke also experienced the same thing, from rank 5 to rank 3. The report also shows a picture of global mortality from cardiovascular disease in 2007–2017, which experienced an increase in the death rate. This applies to all ages and both genders. The death rate increased approximately from 217 people in 2007 to 232 people in 2017, with one death per 100,000 population. Therefore, the biggest cause of death from various types of non-communicable diseases is cardiovascular disease. This is indicated by the percentage value of 43.3%, or 17.8 million deaths in 2017.

This causes non-communicable diseases to be the largest cause of death globally in 2017, which is 73.4%, or 41.1 million deaths. This figure has increased compared to 2007; it was 33.5 million. [17], [18] As a result, ischemic heart disease and stroke are predicted to be the main causes of premature death in 2040. These two non-communicable diseases are still consistently ranked 1st and 2nd in 2014 when compared to 2016. Meanwhile, diabetes will increase its rank from 15th to 7th in 2040. Other non-communicable diseases will also increase in rank, while most communicable, maternal, neonatal, and nutritional diseases are likely to decline, except for lower respiratory tract infections, which will remain in rank. [17]

Non-communicable diseases in particular also drive the burden of disability because they cause 80% of disability in 2017. Several diseases, such as T2DM and fatty liver, will cause increased disability in metabolic conditions worldwide at various stages of development. One of the leading causes of disability globally for all ages in non-communicable diseases is diabetes. Other causes are

mainly low back pain and headache disorders, which include migraines. When compared between 1990 and 2017, diabetes has increased in rank as the leading cause of global disability. It was ranked 9th in 1990 and 4th in 2017. This report also shows that there are differences in the main causes of premature death and disability among countries classified as socio-economical. The Demographic Index (SDI) ranges from low to very high. Diseases found in countries with low SDI are infectious, maternal, neonatal, and nutritional diseases. Meanwhile, non-communicable diseases are found in countries with high SDI. Ranks 1-4 will be occupied by ischemic heart disease, low back pain, stroke, and lung cancer. The socio-demographic measurement index covering three different aspects of development is referred to as the SDI. These aspects of development are income, education, and fertility. [17]

Between 1990 and 2017, there was a change in the main risk factors for premature death and disability. Malnourished children, premature pregnancy or early birth, and low birth weight for pregnancy were the main risk factors in 1990. Meanwhile, the risk factors in 2017 were high blood pressure, smoking, and high blood sugar. The ranking of these three risk factors differs between women and men. Smoking, high systolic blood pressure, and high fasting plasma glucose were ranked 1, 2, and 3 in males. These three levels in a row in women are high systolic blood pressure, high fasting plasma glucose, and high Body Mass Index (BMI) values. The predictions of these three risk factor rankings in 2040 are that they will have high BMI, high blood pressure, and high blood sugar. The potential number of lives that could be saved if exposure to these risk factors were reduced was around 81 million, 79 million, and 60 million, respectively. [17].

The same thing also happened in Indonesia, namely the shift in disease conditions from infectious to non-communicable. This is in line with demographic changes for the population aged 65+, which is predicted to triple from 2015 to 2045. Although the productive age (14-64 years) is still around for more than 60% of the total population during 2015-2045. There is a change in Indonesia's population from around 266 million (in 2015) to 300 million (2045). Population dynamics changes (age distribution, mortality, fertility, life expectancy, urbanization, and dietary changes) have led to rapid epidemiological changes from communicable to non-communicable diseases over the last 25 years.

This non-communicable disease contributed to 70% of overall deaths in 2017, compared to 39.81% in 1990, making it the burden of disease for that year. Of the 10 root causes of death in Indonesia in 2017, six of them were non-communicable diseases. There was an increase in the incidence of stroke in just 10 years (2007–2017), i.e., 29.2%, so stroke was the leading cause of death during that time. Almost the same value (29%) also occurred in ischemic heart disease as the second cause of death. Diabetes is the disease with the most significant increase because there was an increase of three ranks in 2017 from the sixth rank in 2007. This diabetes disease ranks below ischemic heart disease. There is an increase in the percentage of incidence up to 50.1%. High systolic blood pressure, dietary risk, high fasting plasma glucose levels, smoking, and child and maternal malnutrition are the 5 risk factors that contribute to Disability Adjusted Life Years (DALYs), starting from the largest. [19]

### **Strategi terbaik penatalaksanaan penyakit degeneratif sebagai penyakit kronik**

The best strategy for controlling major chronic diseases should focus on monitoring and preventing the progression of chronic diseases at an early stage. This is because chronic disease has two main characteristics: once a person is exposed to a chronic disease, it will remain for almost all of their lives without ever fully recovering, and complications of chronic disease may cause high rates of death and disability. New diagnostic tools need to be developed in this regard, which are based on various molecular biomarkers to observe the physiological state of people in the early stages of chronic disease symptoms so that they can be prevented by diet or therapeutics. Health maintenance management means scientific, behavioral, social, or environmental interventions that will lead to positive changes in people's healthy living habits and lifestyles. This is a successful prevention method and will systematically control major chronic diseases. The focus on fighting chronic diseases in the future will lead to prevention, so the confrontational strategy against chronic disease is a combination of prevention, health promotion, and therapeutic approaches. [20].

This is in line with various strategies for controlling non-communicable diseases and their risk factors in the 2018 Consolidated Report on Indonesia's Health Sector Review, namely: [19]

1. Improving unhealthy lifestyles such as poor diet, lack of physical activity, and smoking, which are major risk factors for noncommunicable diseases, in order to strengthen the Germas or Healthy Living Community Movement. Changes in behavior to a healthy lifestyle are carried out by supporting increased adoption of various physical activities, creating a healthy environment, promoting education about healthy living, developing early detection of risk factors for non-communicable diseases, as well as providing nutritious and healthy food. The Germas movement is carried out by the government, communities, and the public sector.
2. Improving early detection in noncommunicable disease prevention. Community awareness regarding non-communicable diseases needs to be increased because of the high mortality rate and the possibility of an unproductive population. Various efforts should be made to strengthen the early detection of this disease, which will support the early management of risk factors such as obesity, diabetes, and hypertension. This in turn will reduce the burden of non-communicable diseases. Therefore, early detection capability and capacity should strengthen the level of primary health care through increased routine screening programmes. Primary healthcare facilities supported by BPJS are implementing Minimum Service Standards (MSS), a family-based health approach (PISPK), and a chronic disease management program (Prolanis). These three programs will support early detection of non-communicable diseases.
3. Improving regulations to promote healthy living. Regulations are needed to increase the role of industry in producing nutritious and healthy foods, improve food labeling, and increase consumer awareness. Incentives for the public sector should be created to support these efforts. Limitation of consumption and marketing of minimum food and products that pose health risks (high in salt, sugar, and fat) that can be implemented by implementing measurable targeted taxation.
4. Implementation of health-oriented development. Prevention efforts for non-communicable diseases require the role of various sectors. Supporting infrastructure, provision of nutritious food, and a healthy environment will enable healthy behaviors and lifestyles. This effort will also be supported by other sectors. Health issues should be the main discussion point in policy development for other sectors (health-oriented development).



5. Increased noncommunicable disease surveillance. Data collection systems for non-communicable diseases need to be developed to facilitate a better understanding of the epidemiology of non-communicable diseases in various provinces and districts/cities in Indonesia. Valid data will allow for adequate development of policy development responses to prevent non-communicable diseases.

Strengthening early detection to prevent non-communicable diseases is one of the strategies to control non-communicable diseases and their risk factors in the Bapenas Health Sector Report in 2018. One way is to increase routine screening programs that support early management of risk factors such as obesity, diabetes, and hypertension in order to reduce the burden of non-communicable diseases.

To achieve this goal, the authors formed a study group whose specific objectives were to focus on the design, confirmation, and validation of early detection biomarkers based on specific genetic polymorphisms from genetic maps formed from four non-communicable diseases which, according to Riskesdas in 2018, were included in the top 10 and are a series of cardiovascular diseases, namely hypertension, type 2 diabetes mellitus (T2DM), coronary heart disease, stroke, and osteoporosis. According to Riskesdas (2018), the prevalence of diabetes mellitus in Indonesia is 8.5% based on an examination of blood sugar levels in the population aged 15 years. Hypertension with a prevalence of 8.36% based on a doctor's diagnosis or taking antihypertensive drugs in the population aged 18 years, while the risk based on measurement results is up to 34.11%. The prevalence of stroke is up to 10.9% based on a doctor's diagnosis in the population aged 15 years. [21]

### **Early detection biomarkers based on genetic polymorphisms of degenerative diseases**

The term polymorphism in this case is important to clarify as the presence of two or more gene variants on the same allele. Thus, at least the common variant must have a frequency equal to or higher than 1% of the population, otherwise the variation is considered a mutation. These changes in normal sequences may involve multiple bases, as in the case of minisatellites or variable number of tandem repeats (VNTRs), which vary in size between 15–70 tandem base pairs. Another polymorphism is microsatellite, also known as short tandem repeats (STR), which is characterized by variations in the

number of nucleotides (2–6 base pairs). Recently, single nucleotide variations, known as SNPs, have been analyzed. [7]

There are at least 3.1 million SNPs, or 1 SNP per kilobase (kb) of DNA sequences in the human genome (Frazer et al., 2007). [22] It is important to know whether a polymorphism is functional or not if you want to understand the basic mechanism of a polymorphism associated with a particular phenotype or the resulting behavior, namely to see whether it changes the function of a gene or a set of genes. The function of the associated polymorphism in most cases is uncertain and must be suspected or extrapolated as an effect of the gene containing this polymorphism. In rare cases, polymorphisms may be variations of non-synonymized coding regions that alter the genes that produce protein structures. Most of the potential polymorphisms as regulatory polymorphisms are located in the coding region, including:

1. Promoters in the upstream, downstream, and intron regions that may influence transcription [23]
2. Introns and untranslated regions (UTR) that are transcribed as RNA may affect transcription, RNA splicing, stability, or translation [24]
3. Intergenic areas' unknown functions [25]

Single nucleotide polymorphisms in individuals may have minimal functional impact, but perhaps due to linkage disequilibrium, the sequence of polymorphisms forming a haplotype will be associated with functional or functional gene expression outcomes. [26] Zajickova and Zofkova (2003) mention four possible mechanisms by which the frequency of polymorphisms may affect the phenotype, namely: [27]

1. a misalignment of links to other traits that results in mutations at nearby loci
2. an effect on the stability of mRNA
3. an effect on the rate of gene transcription (the amount of mRNA) and
4. modifying the resulting amino acid sequence

## **Conclusion**

Many studies have been conducted around the world on gene polymorphisms in hypertension, type 2 diabetes, coronary heart disease, and stroke as a degenerative disease. This research has been carried out for a long time, so the design of biomarkers based on the principle of DNA variation has long been used as an early detection

method for degenerative diseases. Changes in the trend of non-communicable diseases such as degenerative diseases, the main cause of death that occurs in the world, also occur in Indonesia as a developing country.

Degenerative diseases such as diabetes, ischemic heart disease, and stroke are increasing in rank, displacing infectious diseases due to changes in environmental factors such as lifestyle. Indonesia, as a country with the fourth largest population in the world, has thousands of tribes and is a country with many isolated islands, will have a variety of gene polymorphisms. This strongly supports the development of biomarkers for early detection of degenerative diseases that are specific to the Indonesian people based on gene polymorphisms or DNA variations. This biomarker must be cheap, affordable, accessible, and easy to use for the Indonesian people. The use of this biomarker early, for example during growth, will be able to regulate environmental factors that are suitable for future health. For example, healthy lifestyle arrangements can be made during the growth period for people who are detected at high risk of suffering from degenerative diseases. This arrangement is expected to reduce mortality and morbidity if the risk of disease is known early. This does not mean that people who are not at risk do not need to adjust their lifestyle to a healthy pattern. This is because genetic factors influence a small number of disease risk factors, while the majority are environmental factors such as lifestyle.

## References

- [1] "The Science Behind 23andMe AU, DE, FR & EU."
- [2] "DNAku."
- [3] "What do we need to know about online genetic testing? | Pursuit by The University of Melbourne."
- [4] "All Our Tests | Genomic Diagnostics."
- [5] "DNA Health Test."
- [6] "Vital DNA Test | CircleDNA."
- [7] F. Marini and M. L. Brandi, "Genetic determinants of osteoporosis: common bases to cardiovascular diseases?," *Int. J. Hypertens.*, vol. 2010, 2010, doi: 10.4061/2010/394579.
- [8] W. Sukhumsirichart, "Polymorphisms," *Genet. Divers. Dis. Susceptibility*, Oct. 2018, doi: 10.5772/INTECHOPEN.76728.
- [9] Departement Republik Indonesia, *Indonesia Health Profile*. 2012.
- [10] Kemenkes RI, *Profil Kesehatan Indonesia tahun 2016 (Health statistics)*. 2017.

- [11] "Risk Test | ADA." .
- [12] A. Ananta, E. N. Arifin, M. S. Hasbullah, N. B. Handayani, and A. Pramono, "Demography of Indonesia's Ethnicity.," p. 402, 2015.
- [13] G. Hudjashov *et al.*, "Complex Patterns of Admixture across the Indonesian Archipelago," *Mol. Biol. Evol.*, vol. 34, no. 10, pp. 2439–2452, Oct. 2017, doi: 10.1093/MOLBEV/MSX196.
- [14] "Jawa Mendominasi 40 Persen Suku Bangsa Di Indonesia | Databoks." .
- [15] "GENOTYPE DIFFERENCE OF -572 G>C AND -174 G>C IL-6 GENE POLYMORPHISM BETWEEN BALINESE POSTMENOPAUSAL WOMEN WITH OSTEOPOROSIS AND WITHOUT OSTEOPOROSIS," *Bali Med. J.*, vol. 2, no. 3, pp. 121–124, 2013, doi: 10.15562/BMJ.V2I3.56.
- [16] S. R. Prasetyo *et al.*, "Interleukin-6-174 G/C genetic polymorphism in indonesian postmenopausal women," *J. Int. Dent. Med. Res.*, vol. 10, no. Specialissue, pp. 707–710, Jan. 2017, doi: 10.2/JQUERY.MIN.JS.
- [17] "Findings from the Global Burden of Disease Study 2017 | Institute for Health Metrics and Evaluation." .
- [18] G. A. Roth *et al.*, "Global, regional, and national age-sex-specific mortality for 282 causes of death in 195 countries and territories, 1980–2017: a systematic analysis for the Global Burden of Disease Study 2017," *Lancet*, vol. 392, no. 10159, pp. 1736–1788, Nov. 2018, doi: 10.1016/S0140-6736(18)32203-7/ATTACHMENT/OAAA0B77-F3E8-452C-A5C6-4DEBAAEAE82D/MMC2.PDF.
- [19] "The Consolidated Report on Indonesia Health Sector Review 2018 | UNICEF Indonesia." .
- [20] "Chronic Non-communicable Disease Control and Healthcare Management," *Sci. Technol. Public Heal. China A Roadmap to 2050*, pp. 34–38, 2010, doi: 10.1007/978-3-642-05338-2\_7.
- [21] "Laporan Hasil Riset Kesehatan Dasar (Riskesdas) | Badan Penelitian dan Pengembangan Kesehatan." .
- [22] K. A. Frazer *et al.*, "A sequence-based variation map of 8.27 million SNPs in inbred mouse strains," *Nat. 2007 4487157*, vol. 448, no. 7157, pp. 1050–1053, Jul. 2007, doi: 10.1038/nature06067.
- [23] B. N. Chorley, X. Wang, M. R. Campbell, G. S. Pittman, M. A. Noureddine, and D. A. Bell, "Discovery and verification of functional single nucleotide polymorphisms in regulatory genomic regions: current and developing technologies," *Mutat.*

- Res.*, vol. 659, no. 1-2, pp. 147-157, Jul. 2008, doi: 10.1016/J.MRREV.2008.05.001.
- [24] W. Sadee *et al.*, "Pharmacogenomics of the RNA world: structural RNA polymorphisms in drug therapy," *Clin. Pharmacol. Ther.*, vol. 89, no. 3, pp. 355-365, Mar. 2011, doi: 10.1038/CLPT.2010.314.
- [25] P. Y. Liao and K. H. Lee, "From SNPs to functional polymorphism: The insight into biotechnology applications," *Biochem. Eng. J.*, vol. 49, no. 2, pp. 149-158, Apr. 2010, doi: 10.1016/J.BEJ.2009.12.021.
- [26] C. M. Drysdale *et al.*, "Complex promoter and coding region beta 2-adrenergic receptor haplotypes alter receptor expression and predict in vivo responsiveness," *Proc. Natl. Acad. Sci. U. S. A.*, vol. 97, no. 19, pp. 10483-10488, Sep. 2000, doi: 10.1073/PNAS.97.19.10483.
- [27] "Osteoporosis: genetic analysis of multifactorial disease - PubMed."

# **The Impacts of Industry 4.0 and Society 5.0 to the Sovereignty of States Based on International Law Perspective**

Sri Wartini

## **Introduction**

States as the member of international community cannot ignore the development of technology, since technology affects a lot to the relationship among states. Artificial technology is used in many kinds of state relationship may affect the sovereignty of state, since the artificial intelligence and internet technology may potentially steal the national data of a state without any consent of target state. The development of technology has already reached Industry 4.0 which promises to revolutionize industrial production with increased operational efficiency, the development of new business models, services and products [1]. Unfortunately, the 4.0 industry is more focus on the internet connection and artificial intelligence which is recognized as Internet of thing. However, in order to overcome the bad impacts of Industry 4,0 to the society, in 2017 the Prime Minister Japan Shinzo Abe introduces the concept of 5.0 society which focus on the utilization of technology as a product of industry 4.0 to overcome the social problems [2]. Thus, the Internet of thing as a product of industry 4.0 will be used as a tool to make the life of the society more comfortable and more efficient. Indeed, the society 5.0 will create new values to overcome the social problems through “Internet of thing” as the product of industry 4.0. It is said that in the society 5.0, all technology is part of the human being [3].

Definitely, the industry 5.0 affects the sovereignty of states in the context of international law. The Internet of thing which is introduced in the state practices affects the global regulation of cybersecurity is one of the most contentious topics in international law [4]. Cybersecurity which is developed by each state is useful how to protect the national data which is related to its national defend and interest. Indeed, the characteristic of the 5.0 society is the combination of exercising Internet of thing without ignoring the role of the human being in the social development [4]. Indeed, technology is created and designed to assist human being to be able to fulfil their needs effectively. In the context of state sovereignty may be states will be threatened by cyber attack that may happen. However, referring

to the tech-sociologist Ursula Huws explains the internet age as “We are offered a paradoxical universe: geography without distance, history without time, value without weight, transactions without cash.” [6] It can be argued that the internet appears to release us from physical limitations as well as concrete time and place constraints, it has the potential to make the well-known categories and boundaries of daily life more fluid and flexible than before [6]. The state sovereignty that has been established may be disruptive by the development of industry. Hence the aim of the paper is to examine the impacts of industry 4.0 and society 5.0 to state sovereignty.

## **Discussion**

### **Sovereignty and Society Industry 4.0 and 5.0**

Industry 4.0 is a planned industrial revolution, communicated by German government in 2011, with focus on strengthening the competitiveness of manufacturing through high technology strategies [8]. The fourth Industrial revolution, named Industry 4.0, enables a significant impact on manufacturing environment with radical changes in the performance of production operations will affect the labor’s opportunity to get work. The economic impact of this fourth industrial revolution is expected to be significant since it promotes a substantial increase in operational efficiency as well as the development of business models, services and products completely new [9]. The creation of intelligent factories with advanced information, communication and technologies oriented for the future are promoted by this fourth industrial revolution may disturb the right of human being to get a job. The advantages of Industry 4.0 that can be expected, such as specialized solutions for each sector and personalized customer interaction, the facility of manufacturing specific products with low production volumes, increase competitiveness and flexibility with adjustment to constant value chain changes, accelerated growth in productivity and operational efficiency [10].

The development of Industry 4.0 affects the international relations among states to fulfill the need of their citizens. It is clear that sovereignty is an important aspect to maintain good relationships, since sovereignty give a freedom to the states to determine what kinds of relationships that will be performed. The Internet of thing which is developed by Industry 4.0 contributes to the harmonization of state relationship, however, the Internet of thing can also be used for positive and negative objectives, such as

the Internet of thing can be used for espionage objective, [11] or even for disguises imperialism to force other states to obey what the other states deserve. Besides that, the Internet of thing can also be used to steal information related to national defend which violates state sovereignty [12]. Thus, it depends on the purpose of each state to utilize the Internet of thing. Indeed, the effort to developed the technology has already solve some problems, such as the flow of information and the inter connection between state to cooperate in combating terrorism, human trafficking and also the other threats that may occur in a certain state.

Society 5.0, on the other hand, focuses on assigning the human being at the center of technological and innovation modification for the benefit of humanity, and it is regarded as a quiet revolution that began in Japan and promises to revolutionize society [2]. The primary goal of Society 5.0 is to improve people's quality of life by leveraging the capabilities of Industry 4.0. With the implementation of new methodologies such as autonomous trucks for order delivery or drones, Japan is already moving toward Society 5.0 [14] Meanwhile, the rest of the world is adjusting to the challenges posed by Industry 4.0. Indeed, the establishing of society 5.0 in one side is to achieve more comfortable life where the human being as the center and the priority to obtain good services by utilizing the product of industry 4.0, but not all states have the capability to materialize it. It is become big problems in developing countries to provide infrastructures and the regulations.

Anticipating approximately 40% of the population being over the age of 65 by 2050, Japan introduced 5.0 society [14]. To address today's societal quandaries, Japan uses advanced technology such as big data, robotics, artificial intelligence, drone deliveries, and autonomous trucks. Japan's future growth strategy includes training to meet sustainable development goals as well as the creation of a super-intelligent society. Japan promotes a Society 5.0 services platform to coordinate collaboration between academia, government, and industry. As a result, Japan moves boldly forward, calling for future development as a Society 5.0, with changes affecting aspects of society and industrial production. [15] Hence, the development of Technology potentially can improve living standards, but it may also have a negative impact on employment, unequal wealth distribution, and information distribution [16]. Society 5.0 allows for the use of advanced technologies such as IT, IoT, robotics, artificial intelligence, and augmented reality in people's



lives, health, and other areas of activity, whereas Industry 4.0 limits technological advances only to the industrial sector [17]. Thus, it depends on human being to decide which path to take and what kind of society we want to build in the future.

The diversity of technologies for the benefit of humanity, such as increased production, cost mitigation associated with an aging society, equitable wealth distribution, reduction of greenhouse gases, reduced food products, correction of regional inequalities, and others, could solve social problems and spur economic growth. Thus, technology developed in industry 4.0 that becomes a tool of society 5.0 requires legal instruments to be implemented at the national level without jeopardizing a state's sovereignty [18]. Society 5.0 combines digital transformation with the creativity of various people for sustainable development through problem solving and value creation, and it aimed to achieve sustainable development goals. There are, however, some challenges and opportunities to improve international cooperation without jeopardizing state sovereignty [19] The aim of the paper is to examine the challenges and opportunities of state sovereignty in the implementation of industry 4.0 and society 5.0 based on international law perspective.

### **The Challenges of State Sovereignty in the Era of 5.0 Society**

The 5.0 society introduced by the Prime Minister of Japan will change the nature of international law. It is recognized under international law that each state has a freedom to determine its own policy related to the economic and political relationship as well as to establish national defend, however, threat may happen due to the utilization of Internet of thing by other states. Moreover, the development of 5.0 society is not always in accordance with the situation and condition of each state. The infrastructure and also the technology that have to be performed is not a simple thing that can be overcome in a short time. What happen in most developing countries? Are they going to possess the technology which focus on the internet connection and artificial intelligence? I believe that these technologies will be helpful and useful for human being especially in the developed countries which the population are not so huge and their society are ready to utilize the technology. Hence, there are some challenges that may be faced in the developing countries which may affect the sovereignty, namely :

First, the technologies which are available in the developing countries are not able to adapt with the Internet of thing. However,

this situation and condition will cause the developing countries to have transfer of technology which may very costly and may infringe the freedom of state to determine their own policy and it will restrict the human creativity due to the application of the products of industry 4.0 [20]. Second, there will be such an intervention [21] that may occurs from the developed states to impose the developing countries to use and develop these kinds of technology, that may contradict with the culture of the society. Third, the involvement of foreign entities in the development of technology may affect the independency of state to self-determination, since states have to follow the international system where the Big Data [22]. can be used to disseminate information that need to be protected. Fourth, the possibility of cyber attack that may affect the national security of states and it also disturbs the sovereignty of states [23]. Furthermore, the data that observed from a certain state it may without any consent of the state can be disclosed in the internet that everybody can access the important data of a state which actually is not allowable to be disclose in the public. Hence, it is important to adopt the law which is applicable to the utilization of 4.0 technology in the society 5.0. In the absent of international law to regulate the Internet of thing will cause many problems in international relation.

### **The Opportunities of Exercising State Sovereignty in the Era of 5.0 Society**

Society 5.0 offering some opportunities of states to maintain their sovereignty in order to protect their national interest. Establishing society 5.0 caused challenges and opportunities to implement state sovereignty. It is recognized that based on international law state sovereignty is relative not absolute, because states voluntarily obey international law, so the sovereignty is limited by International law. Society 5.0 will be exist in a state when the state has willingness to do so, in the absent of political will of the state, the 5.0 society will not exist. Thus, it can be submitted, even though state sovereignty is not absolute, a state still has a freedom to determine what kind of society that will be developed in the state and sate has the right to develop cyber sovereignty [24]. It is the right of state to determine what kinds of society that will be established. If establishing society 5.0 is more advantages for the society and it can increase the welfare of the society, a state has a freedom to materialize it. Indeed, there are some opportunities to maintain state sovereignty in the Era of 5.0 society, namely:

First, as a sovereign state can manage what kinds of technologies in industry 4.0 that can be used to improve the welfare of the society by combining the technology and the value that which exist in the society. Each state has a freedom to develop and to determine the Internet of thing which is appropriate to the nature and condition of its society. Second, a state can cooperate to other states in implementing Internet of thing to reduce the bad impacts of industry 4.0 which more focus on the role of technology by combining the existence of human being as the user of the technology as a partner in order to achieve sustainable development goals in various aspects of life [25]. Third, cooperation to combat cyber attack in order to protect national interest, since the 5.0 society is so dependent to the functioning of the internet system and artificial intelligence [26]. Fourth, the establishing of 5.0 society needs a change of thought that it is necessary to utilize the technology to overcome social problems, such as improving the ability of state to use the internet of thing to monitor the foreign vessel which illegally conducting illegal, Unreported and unregulated (IUU) Fishing. Fifth, the technology also can be used to detect the spot of forest fire so it can be used to prevent the fire not spread out to larger area or to other states.

However, in order to prevent and redress transboundary harm, a state must exercise due diligence to avoid causing harm to other states when using the internet of thingk technology. The duty not to cause harm or damage to others can be traced back from the Roman law maxim of *sic utere tuo ut alienum non laedas*. Based on the maxim each sate is not allowed to use its property in a way that causes harm to another's. Hence, the state practices to prevent and remedy transboundary harm have played a role in a number of ICJ cases, such as 1997 *Gabcikovo-Nagymaros Project (Hungary v. Slovakia)* judgment and 2010 *Pulp Mills on the River Uruguay (Argentina v. Uruguay)* judgment and also *Ecuador v. Columbia* [27]. Thus, it can be submitted, a state based on its own sovereignty does not have any right to cause disadvantages to other states using the internet of thing, otherwise, state will be responsible to the harmful impacts of internet of thing to other states. The state responsibility may in the form of satisfaction, compensation and restitution or the three forms of state responsibility have to be performed at the same time depends on the characteristics of the cases.

## Conclusion

State sovereignty is crucial aspect in the international law perspective. Based on the united Nations charter states are not allowed to intervene other state both directly and indirectly. However, the development of industry 4.0 and the development of society 5.0 may potentially affect the sovereignty of states. The Internet of Thing technology as the product of industry 4.0 is able to eradicate physical border among states. Thus, it can be argued that sovereignty are threaten by the existence of he Internet of Thing. Thus, It is important to create legal instrument to regulate the implementation of industry 4.0 and society 5.0 in international level and in national level to protect the national interest of state and to maintain the sovereignty of states.

## References

- [1] UNESCO, "Japan pushing ahead with Society 5.0 to overcome chronic social challenges", 2019, <https://en.unesco.org/news/japan-pushing-ahead-society-50-overcome-chronic-social-challenges>
- [2] Rojas. C.N. et.al, "Society 5.0: A Japanese Concept for a Super Intelligent Society", *Sustainability* , pp. 1-16, 2021, <https://doi.org/10.3390/su13126567>
- [3] Hitachi and The University of Tokyo, *Society 5.0 A People-centric Super-smart Society*, E\_Book, Hitachi and The University of Tokyo Joint Research Laboratory, Hitachi and The University of Tokyo Joint Research Laboratory, Springe Open, 2018, page2.
- [4] Kilovaty Ido, "Privatized Cybersecurity Law", *UC Irvine Law Review*, (June, 2020), pp. 1181-1218.
- [5] Tammy Katsabian, "The Rule of Technology: How Technology Is Used to Disturb Basic Labor Law Protections", *Lewis & Clark Law Review*, (2021), pp. 895-981. (906)
- [6] Tammy Katsabian, "The Rule of Technology: How Technology Is Used to Disturb Basic Labor Law Protections", *Lewis & Clark Law Review*, (2021), pp. 895-981. (906)
- [7] Shu Ing Tay. et.al., " An Overview of Industry 4.0: Definition, Components, and Government", *Initiatives Journal of Advanced Research in Dynamical and Control Systems*, Vol 10, pp. 1379-1387, 2018 available at <https://www.researchgate.net/publication/332440369> last visited 1 december, 2021.

- [8] UNIDO, “What Can Policymakers Learn From Germany’s Industry 4.0 Development Strategy? Inclusive and Sustainable Industrial Development Working Paper Series WP 22, pp. , 2018, available at <https://www.unido.org/api/opentext/documents/download/11712839/unido-file-11712839> last visited on 1 December 2021
- [9] Johannes Horst & Fernando Santiago, “What Can Policymakers Learn From Germany’s Industry 4.0 Development Strategy? UNIDO, Inclusive and Sustainable Industrial Development Working Paper Series WP 22, pp. 1-35, 2018
- [10] Paul Timmers, “Challenged By “Digital Sovereignty”, Journal of Internet Law, pp. 1-19, 2019. [[12] Beatrice A. Walton, “Duties Owed: Low-Intensity Cyber Attacks And Liability For Transboundary Torts In International Law”, Yale Law Journal, Vol. 126, pp. 1460-1519, March, 2017
- [11] Carolina Narvaez Rojas. et.al, “Society 5.0: A Japanese Concept for a Super Intelligent Society”, Sustainability , pp. 1-16, 2021, <https://doi.org/10.3390/su13126567>
- [12] Andreia G. Pereira, et.al, “Industry 4.0 and Society 5.0: Opportunities and Threats”, International Journal of Recent Technology and Engineering (IJRTE), Volume-8 Issue-5, pp. 3305-3308, 2020. DOI: 10.35940/ijrte.D8764.01852
- [13] Center for Research and Development Strategy Japan Science and Technology Agency. “Future Services & Societal Systems in Society 5.0 “, CRDS-FY2016-WR-13, November,2016.
- [14] Michael Sony, “Pros and cons of implementing Industry 4.0 for the organizations: a review and synthesis of evidence”, Production & Manufacturing Research, VOL. 8, NO. 1, 244-272 2020, <https://doi.org/10.1080/21693277.2020.1781705>
- [15] Barbara Aquilani , et. al, “The Role of Open Innovation and Value Co-creation in the Challenging Transition from Industry 4.0 to Society 5.0: Toward a Theoretical Framework’, Sustainability Sustainability, Vol. 12, 2020, doi:10.3390/su12218943
- [16] Andreia G. Pereira, et.al, “Industry 4.0 and Society 5.0: Opportunities and Threats”, International Journal of Recent Technology and Engineering (IJRTE), Volume-8 Issue-5, pp. 3305-3308, 2020. DOI: 10.35940/ijrte.D8764.01852
- [17] John W. Head, “Addressing Global Challenges Through Pluralistic Sovereignty: A Critique of State Sovereignty as a Centerpiece of International Law”, University of Kansas Law Review, Vol. 67, pp. 727-821, 2019.

- [18] Andrew Keane Woods, "Litigating Data Sovereignty", *Yale Law Journal*, Vol, 128, pp. 328-406, 2018
- [19] Violeta Sima et.al., "Review Influences of the Industry 4.0 Revolution on the Human Capital Development and Consumer Behavior: A Systematic Review ", *Sustainability*, Vol, 12, pp. 1-28, 2020, doi:10.3390/su12104035
- [20] Sean Watts, Theodore Richard, "Baseline Territorial Sovereignty and Cyberspace", *Lewis & Clark Law Review*, Vol 22, pp. 771-840, 2018.
- [21] David Bollier , *The Promise and Peril of Big Data*, The Alpen Institute, Communications and Society Program One Dupont Circle, NW, Washington, DC. 2010.
- [22] Nicolas Jupillat, "From The Cuckoo's Egg To Global Surveillance: Cyber Espionage That Becomes Prohibited Intervention", *North Carolina Journal of International Law*, Vol. 42, pp. 933-988, 2017
- [23] Mitra V. Yazdi, "The Digital Revolution and The Demise of Democracy", *Tulane Journal Of Technology And Intellectual Property*, Vol. 23, pp. 61-99, 2021 Maria E. Mondejar, et.al, "Digitalization To Achieve Sustainable Development Goals: Steps Towards A Smart Green Planet", *Science of the Total Environment*, Vol, pp. 1-28, 2021, <https://doi.org/10.1016/j.scitotenv.2021.148539>
- [24] Maria E. Mondejar, et.al, "Digitalization To Achieve Sustainable Development Goals: Steps Towards A Smart Green Planet", *Science of the Total Environment*, Vol, pp. 1-28, 2021, <https://doi.org/10.1016/j.scitotenv.2021.148539>
- [25] Eyal Benvenisti, "Upholding Democracy Amid The Challenges Of New Technology: What Role For The Law Of Global Governance?;", *European Journal of International Law*, Vol. 29, pp. 9-82 , 2018
- [26] Asia-Pacific Information Superhighway (AP-IS) Working Paper Series , "Enhancing Cybersecurity for Industry 4.0 in Asia and the Pacific", 2018, [https://www.unescap.org/sites/default/files/Cybersecurity\\_WorkingPaper-edit.pdf](https://www.unescap.org/sites/default/files/Cybersecurity_WorkingPaper-edit.pdf)
- [27] Paola Solano, "Colombia's Herbicide Spraying In The Crucible Between Indigenous Rights, Environmental Law And State Security", *Intercultural Human Rights Law Review*, Vol. 9, pp. 271-317, 2014



# Strengthening Financing Reform for MSMEs in the Society Era 5.0

Sriyono<sup>107</sup>

## Introduction

Many MSMEs are unable to continue their business due to the emergence of the Covid 19 Pandemic, coupled with the "appeal stay *at home*" which automatically affects people's income from their routine significantly, economic activity is very limited, due to the declining supply of goods [1]. There are many sources of financing for micro, small and medium enterprises (MSMEs), starting from banks and non-bank financial institutions. However, the problem is that it is difficult to get access to these sources of financing [2] besides that there is no match between the source of financing and the type of financing so that it becomes the main obstacle faced by MSMEs to increase capital [3]

This study is the development of an initial study that has been carried out by [4] Regarding the many financing models offered to MSMEs, there are 4 (four) models that can be used by MSMEs to be able to obtain financing, however which model is most suitable for MSMEs due to the impact of the Covid 19 Pandemic. The impact of Covid 19 still cannot be eliminated so we need an appropriate financing model to be able to help MSMEs and restore their business performance.[5] The weak competence of MSMEs adds to the bigger problems that exist because MSMEs are not able to innovate and be creative to overcome these problems.[6]

In handling the problem of the impact of Covid 19, the government uses policy paths from two directions, namely substantive policies (prevention) while focusing on economic improvement policies. [7] Two policies were implemented simultaneously with the hope that they could immediately overcome the impact of Covid 19, however, these steps caused the implementation to be not optimal and inconsistent, even there tended to be mis-coordination between the central government and local governments [8]. This condition has not only disrupted the economy but has also disrupted economic movement. [9]. The current crisis due to Covid-19 is happening simultaneously, so the consequences are being felt by vulnerable groups who are getting worse, including

---

<sup>107</sup> Universitas Muhammadiyah Sidoarjo



business groups that need mass crowds, groups of casual daily workers, street vendors, workers affected by layoffs, farmers, the poor, [10]. In this situation, it is understandable that the government does not dare to take the step of *lockdown* in this phenomenon, because the risk leads to an *economic disaster*, which automatically has implications for other social impacts. The government must take accelerative strategic policies in dealing with economic difficulties that beset the community [12]. If the government is slow in making strategic decisions, then the vulnerability to the occurrence of *social disasters*, including conflict will be very easy to occur. Therefore, this phenomenon is very important to be studied empirically regarding strategic policies in dealing with economic externalities during this pandemic, especially for vulnerable groups.

This vulnerable group includes MSMEs, although the role of MSMEs is quite large in reducing unemployment, as well as contributing to the GDP of a developing country [13]. But on the other hand, it has considerable obstacles in financing [14]. However, MSMEs help create most of the jobs and contribute to national income by way of tax revenues, but also increase national income [15]. Creating a business environment-friendly through the stability of law and policy, the legal system is fast and functional, reducing bureaucracy, corruption is low, encourage innovative companies and performers, investment and job creation is the solution to increasing the number of SMEs [7]has

The government launched many programs in in order to overcome the financial problems faced by MSMEs, both from banking and non-banking, however, it did not provide the implications as expected. The obstacle faced is that the requirements are difficult to fulfill, therefore it is necessary to find a breakthrough that is maximal and effective to overcome this [16] The

hope of the wider community and the government is that the existence of large companies is expected as an 'agent of development' to have responsibility for the impact of a development so that companies can carry out social responsibility known as Corporate Social responsibility (CSR), through this responsibility will be able to help MSMEs. However, CSR or often interpreted as "being socially responsible" provided by each company is different. It is clearly a different way for different people in different countries. So it is necessary to be careful in applying the concept of CSR from developed countries in developing countries.

The study that has been carried out by [5], has found several financing models for MSMEs, but not all of these models can be used to finance MSMEs in this COVID-19 condition, from the results of interviews with MSMEs, it turns out that the type of financing comes from the social community or appropriate CSR. This is because the requirements provided do not burden MSMEs at all, besides that the costs provided are not at all burdensome. However, in Era Society 5.0, the current financing model does not provide great benefits for MSMEs because they are still dependent on other parties.

The Society 5.0 concept is a refinement of the previous concepts. Society 5.0 was created as a resolution to industry 4.0 resolutions. In the Era of Society 5.0 where all technology is part of humans themselves, the internet is not only used to share information but to live life.[17] This concept allows us to use modern science-based (Artificial intelligence, Robot, *Internet of Things*) for human needs with the aim that humans can live comfortably. [18]

The concept of resolution Industry 4.0 and Society 5.0 actually does not have much difference, but the concept of Society is more focused on the context of humans. If the industrial revolution uses Artificial Intelligence, and artificial intelligence as its main component, while Society 5.0 uses modern technology, it only relies on humans as its main component. In Society 5.0 where the main component is humans who are able to create new value through technological developments, it can minimize the gap in humans and economic problems in the future. Indeed, it seems difficult to do in a developing country like Indonesia, but that does not mean it cannot be done.

The capital problems faced by MSMEs can actually be overcome by MSMEs themselves, in the era of society 5.0 MSMEs are required to be able to carry out creativity and innovation in overcoming these problems. At first glance, capital is indeed the main problem in solving current problems, however, in fact the biggest problem is the ability of MSME resources themselves [19]. In the Era of Society 5.0, reforms must be made to the mindset of MSMEs, which do not only think about financial needs but must begin to look at strengthening their own abilities. It is necessary to strengthen a more comprehensive knowledge of life in order to be able to pass the competition in the current conditions.

Indonesia must also be ready to face the change to *Society 5.0*, where a large amount of information from physical area sensors is accumulated into cyberspace. In *cyberspace*, *big data* is analyzed by

*Artificial Intelligence* (AI), and the results will be returned to the physical area for use by the community. [19] The key is that we still have to build digital talent and increase digital literacy to the general public, especially MSMEs. For that we need a concept that can be representative of all parties.

## **Discussion**

Financing for MSMEs is very important because at this time many MSMEs are experiencing problems in accessing capital from banks. Most of the UMKM business establishments are started from family activities which are then turned into a business. Therefore, most of them do not understand how to manage company money and access sources of financing [20] and they cannot even distinguish between company and family money. As a result, it is difficult for them to develop their business, because according to them, any money earned is also family money, so that the use of the money earned is used for family and personal interests. In the end the money ran out so that no more money was used for working capital.

Therefore, the meaning of financing is very important for MSMEs to be able to develop their business. Small industries that obtained credit facilities from banks stated that the credit was very beneficial for their business development. The credit is mainly used for capital turnover and partly for investments related to equipment and business capital, including business premises [21]. Given these conditions, the urgent assistance needed at this time is capital assistance for the settlement of non-performing loans and business recovery through the inclusion model. [22]. Urgent capital assistance was given because only a small number of MSMEs were able to return their credit without any relief, the rest stated that they were unable to repay if there was no relief. The reliefs in question are write offs, hair cuts, and a credit moratorium [23]

Currently, in Indonesia, online fundraising activities are being developed through crowdfunding sites to support creative projects by the nation's children [24]. The emergence of this fundraising if properly channeled will affect the company's financial performance and ultimately the company will be able to innovate[25]. However, MSMEs still do not understand the existence of fintech, so in the end this facility has not been used by MSMEs properly.

The importance of financing for MSMEs, in addition to overcoming the problems faced today, it is also hoped that this financing will be able to increase competitiveness in the current era.

[26]. The meaning of financing for MSMEs is very important, although sometimes MSMEs are also very careful in receiving this financing either through credit or other means because the risk is quite high. [27]. Although sometimes there is financing provided by the banking sector which is very easy and the burden is small, MSMEs who really understand money management will be careful, it is better to be safe than sorry after making the credit.

In the current Era of Society 5.0, the model -Financing models originating from third parties are no longer a hope for MSMEs because access to obtain and the desired conditions are very fallacious, besides that the level of sustainability of the model is still in doubt, especially in the conditions of the COVID-19 pandemic. Therefore, it is necessary to revitalize the model -the financing model. Strengthening SMEs do not have to provide financial assistance directly provided to SMEs however, in the era of society 5, is required is the strengthening of the human resources managers of SMEs

the Industrial Revolution 4.0 is currently producing a presumption that the Industrial Revolution not only decrypting technology area, but encroaching upon the in the social, economic and legal fields and to cope with the impact of the Industrial Revolution, it is necessary to have a humanities study to guard the development of technology so that it does not deviate from the prevailing humanitarian norms. (28)

Changes in people's behavior that follow technological developments and are centered on human needs are currently more known as Society 5.0. In the era of Society 5.0, every order of community needs will be human-centered and technology-based developed by Japan [29]. The development of Society5.0 has actually started since civilization in the world began. This is characterized by every behavior of the community that is centered on the needs of the community. If the Industrial Revolution discusses how the existence of industry can make it easier for humans to carry out all activities, it is different with Society5.0 which focuses more on humans not only as objects, but also playing an active role in achieving goals.

In the era of Society 5.0 technology and information are not the focus of the movement of human life. In this era, humans will become objects of innovation, where technology and information will be equipped with big data processing and artificial intelligence that will facilitate every human need. One of the biggest impacts is on changes in social and economic behavior. In society 5.0, new value created through innovation will eliminate regional, age, gender and

language disparities and enable the provision of tailored products and services. for various individual and group needs[30]. In this way, it is possible to achieve a society that can promote economic development and find solutions to social problems. However, this achievement will have difficulties or obstacles, Japan is ready to face it head-on with the aim of being the first in the world as a country facing problems to present a model of a future society.

In principle, society 5.0 continues the technology that existed in industry 4.0 and is still running today. Big data, cloud and IoT are a necessity and must be implemented in industry 4.0 and society 5.0. Robots in industry 4.0 already use artificial intelligence and sensors. Drone technology is used in industry 4.0 and society 5.0. 3D Print is also used in Industry 4.0 and Society 5.0. Meanwhile, public key infrastructure is one of the data security system facilities used in society 5.0 where Public key infrastructure is part of cyber security in industry 4.0

Sharing is an information sharing technology that is applied in industry 4.0 [31] and society 5.0. On demand is a technology to serve demand, it is also used in industry 4.0 and society 5.0. Simulations in industry 4.0 use virtual reality, augmented reality and mixed reality and these technologies are also used in society 5.0. Then mobile technology is a mobile device that is integrated with edge cellular networks (2G, 3G, 4G and others) and is applied to industry 4.0 and society 5.0.

In the era of Society 5.0, every behavior of life will be translated with artificial intelligence (artificial intelligence) then it will be transformed with millions of data via the internet (internet of thing). The results of the translation will be dedicated to become a new wisdom that will increase human abilities in opening up opportunities for humanity.[32] One of the things that affect the behavior of people's lives is changes in global economic flows. The current existence of the Indonesian economy has been dissolved in global economic conditions, this greatly affects the Indonesian economy if there is an increase or decrease in global economic conditions.

Society 5.0 promises various kinds of conveniences for humans in meeting their needs. This has been clearly seen in Indonesian society. The presence of various companies that provide online-based goods and services has spread widely in Indonesia. The behavior of the economic community who prefers the online system for the sake of convenience in fulfilling all aspects of life requires

business people to compete to determine the best strategy for competitive advantage. MSMEs, which are one of Indonesia's leading industries, must change their business strategy by utilizing technology so they are not left behind by other business actors.

Society 5.0 was originally a vision of the Japanese government in improving the welfare of its people in the future. This welfare is achieved by utilizing technology so that it can balance economic progress with solving social problems that are human-centered and facilitate all lines of people's lives. Financing for MSMEs existed before Society 5.0, which also aims to increase capital. However, before the existence of society 5.0, the financing process that occurs in MSMEs must meet several complex administrative requirements. In addition, when the MSME returns the funds, it is added with the interest required by the financial institution.

So the financing model in the 5.0 era has its goals and framework, dimensions and technology. In society 5.0 it is described that every activity carried out by humans is highly dependent on technology. Technology has become a basic need in the joints of human life, all integrated with smartphones. In business transactions, people are also dependent on technology so they don't want to do traditional business transactions anymore. In this way, the financing model will be a phenomenal initial breakthrough and will become the prima donna in business transactions, so that the prospects are brighter.

In connection with this, all financial processes in the era of society 5.0 must begin to change in line with the needs of MSMEs. Society 5.0 will fulfill all customer desires. Financing for MSMEs must be revitalized easily for SMEs to enjoy. This starts from the ease of access, for example all financing systems and models are available digitally. The government regulates existing policies, namely all financial institutions provide applications on social media. In addition, access to financing for MSMEs must be facilitated and completely burdensome for MSMEs.

## **Conclusion**

The current financing model must be revitalized because it is very difficult for MSMEs. The current model of the process of obtaining financing requires complete administrative requirements while MSMEs have never had it. Therefore, it is necessary to revitalize financing by using a digitalization financing model. Dima started from

access to funding, to the execution of the disbursement of funds to the payment system abbabyaæmmm

## References

- [1] Mas'udi, Wawan & Poppy S. Winanti. 2020. Covid 19: From a Health Crisis to a Governance Crisis. Faculty of Social and Political Sciences UGM : UGM Press.
- [2] Bartoli, F Ferri, G., Murro, P. and Rotondi, Z. (2014). Bank support and Export: evidence from small Italian firms. *Small business Economics*, 42, pp. 245-264.
- [3] Mensah, S., 2004. *A review of SME financing schemes in Ghana*. UNIDO Regional Workshop of Financing SMEs, Accra
- [4] Sriyono, Sarwendah Biduri, Bayu Prasajo (2019). Analysis and Identification of Non State Budget Financing Models for Green Economy-Based MSMEs, *Proceedings of the 5th National Scholars Seminar*, ISSN (F) : 2460 - 8696 Book 2: Social and Humanities—ISSN (E) : 2540 - 7589
- [5] Sriyono, Sarwendah Biduri, & Hari Bayu Prasajo. (2021), Acceleration of performance recovery and competitiveness through non-banking financing in SMEs based on the green economy: impact of the Covid-19 pandemic. *Journal of Innovation and Entrepreneurship* 10 (1), 1-10
- [6] Anis Ali & Firoz Hussain. (2014). MSMEs in India: Problems, Solutions and Prospects in present scenario. *International Journal of Engineering and management Sciences*, Vol.5 (2) 2014: 109-115.
- [7] Dumitru, Nancu, Mitea Neluta (2017), The Access of SMEs from Romania to Financing through Financial Instruments. Impact and Results, Economic Sciences Series Volume XVII, Issue 1
- [8] Budi, Arya & Irham Nur Ansari. 2020. “Administration Distancing?”, Local Government in the Covid-19 Pandemic. Faculty of Social and Political Sciences UGM: UGM Press
- [9] Barro, Robert J. 2020. Lessons from the “Spanish Flu” for the Coronavirus's Potential Effects on Mortality and Economic Activity Department of Economics Harvard University 1805 Cambridge Street USA - Cambridge MA 02138-3001 rb.
- [10] Eddyono, Suzanna, et. al. 2020. Pandemic and the Displaced: Assessing the Urgency of Inclusive Policies in Handling Covid-19. Faculty of Social and Political Sciences UGM: UGM Press.

- [11] Abodunrin, Oyinlola, *Gbolahan Oloye, And Bola Adesola. 2020. Coronavirus Pandemic And Its Implications On Global Economy. IJALBS For Academic Research. Vol 4.*
- [12] Olaniyi, Evans. 2020. Socio-economic impacts of novel coronavirus: The policy solutions. *BizEcons Quarterly*, Strides Educational Foundation, vol. 7, pages 3-12.
- [13] Cook, P., & Nixon, F. (2000). Finance and small and medium-sized enterprise development, *Finance and Development Research Program Working Paper Series*, (14). Institute for Development Policy and Management, University of Manchester
- [14] Deakins, D., North, D., Baldock, R., & Whittam, G., 2008. SMEs' Access to finance: Is there still a debt finance gap? *Institute for Small Business & Entrepreneurship*. 5-7 November 2008 - Belfast, N. Ireland, 1-19
- [15] Abor, JY, Agbloyor, E. and Kuipo, R. (2014). Bank finance and export activities of small and medium enterprises. *Review of Development Finance*, Vol. 4, pp. 9-10.
- [16] Paulet, E., Parnaudeau, M. and Abdessemed, T., 2014. The SME struggle for financing: a clampdown in European banks post crisis. *Journal of Business Strategy*, Vol. 35. Issues. 2.pp. 36-45.
- [17] Pereira, Andreia G, Tânia M Lima, and Fernando Charrua-santos. 2020. "Industry 4.0 and Society 5.0: Opportunities and Threats." *International Journal of Recent Technology and Engineering* 8 (5): 3305-8.
- [18] Faruqi, Umar Al. 2019. "Future Service in Industry 5.0." *Journal of Intelligent Systems* 2 (1): 67-79.
- [19] Serpa, Sandro, and Carlos Miguel Ferreira. 2019. "Society 5.0 and Sustainability Digital Innovations: A Social Process." *Journal of Organizational Culture, Communications and Conflict* 23 (1): 1-14.
- [20] Alvarez, R. and Lopez, RA (2014). Access to bank finance and exporting. *Industrial and Corporate Change*, 23(6), pp. 152-159.
- [21] Davis, KT, & Murphy, J. (2016). Peer to Peer lending: structures, risks and regulation. Kevin Davis and Jacob Murphy "Peer to Peer Lending: Structures, Risks and Regulation" *JASSA: The Financial Journal of Applied Finance*, 2016, 3-37.
- [22] Irmawati, S., Damelia, D., & Puspita, DW (2013). Financial Inclusion Model in Rural-Based MSMEs. *TRACK: Journal of Economics and Policy*, 6(2).



- [23] Bedman Narteh (2013). SME Bank Selection and Patronage Behavior in the Ghanaian Banking Industry, *Management Research Review*. Vol. 36 (11). PP. 1061 – 1080. 58
- [24] Kustina, KT, Dewi, IGAAO, Prena, GD, & Utari, IGAD (2018). MSMEs credit distribution and non-performing loans towards banking companies profit in Indonesia. *International Journal of Social Sciences and Humanities*, 2(1), 10-23.
- [25] Lussak, A., Abdurachman, E., Gautama, I., & Setiowati, R. (2020). The influence of financial performance and innovation of services and products on the survival of small businesses in food and beverage in the Jakarta city with mediation of operational improvement. *Management Science Letters*, 10(2), 463-468.
- [26] Belás, J., Bartoš, P., Hlawiczka, R., Hudáková, M. (2015). Attributes of financial management of family companies in the Czech republic and Slovakia. *Family businesses in transition economies: Management, succession and internationalization* (pp. 223-238) doi:10.1007/978-3-319-14209-8\_11
- [27] Belas, J., Sopkova, G. (2016). Significant determinants of the competitive environment for SMEs in the context of financial and credit risks. *Journal of International Studies*, 9(2), 139-149. doi:10.14254/2071-8330.2016/9-2/10
- [28] Ramli, Tasya Safiranita, Ahmad M Ramli, Huala A Dolf, Eddy Damian, and Miranda Risang Ayu Palar. (2020). "Over-The-Top Media in Digital Economy and Society 5.0." *Journal of Telecommunications and the Digital Economy* 9 (3): 60-67.
- [29] Melnyk, L.; Kubatko, O.; Dehtyarova, I., Matsenko, O., Rozhko, O. (2019). The effect of industrial revolutions on the transformation of social and economic systems. problem. perspective. *Manag.*, 17, 381-391.
- [30] Ellitan, Lena. 2020. "Competing in the Era of Industrial Revolution 4.0 and Society 5.0." *Maksi Preneur Journal* 10 (1): 1-12.
- [31] Aquilani, B.; Piccarozzi, M.; Abbate, T.; Codini, A. (2020). The Role of Open Innovation and Value Co-creation in the Challenging Transition from Industry 4.0 to Society 5.0: Toward a Theoretical Framework. *Sustainability*, 12, 8943
- [32] Foresti, R.; Rossi, S.; Magnani, M.; Bianco, CGL; Delmonte, N. (2020). Smart Society and Artificial Intelligence: Big Data Scheduling and the Global Standard Method Applied to Smart Maintenance. *Engineering*, 6, 835-84

# Science Education: Its Role in Building Scientific Attitudes in The Context of Society 5.0 Era

Suciati<sup>108</sup>

## Introduction

The industrial revolution 4.0 in the 21<sup>st</sup> century, which is characterized by the use of modern technology-based science, has resulted in various digital innovations such as: internet of things (IoT), artificial intelligence (AI), big data, robotic machines, to fulfill necessities and comfort of life in order to improve the quality of human life. For this reason, the era of society 5.0 is necessary to build digital talent and increase digital literacy in society

Modernization in the era of the Industrial Revolution 4.0 has led us to a situation full of uncertainty and an extraordinary wave of disruption. This has an impact on various aspects of life including social changes in society. This change has become more complex during the pandemic that has occurred over the past two years, where there has been a transformation from off line activities to online activities-based information technology. Although it is undeniable that the existence of modern technology has a positive impact in terms of convenience in various aspects of life, there are negative impacts, especially changes in people's social behavior which are feared to erode the values of human characters that have existed so far.

The phenomenon of the decline in people's social behavior can be seen in real life such as: low caring attitudes towards others and the surrounding environment, loss of empathy for others, increasing selfishness, etc. In the context of education, the use of technology in learning can have both positive and negative impacts, especially student attitudes in learning. This can be seen in various publications of research results such as the emergence of apathy and ignorance and a lack of caring attitude towards the surrounding environment [39]. A similar statement was also stated by psychologists that technology has an impact on changing social life in society where a person will be engrossed in his own life so that it is difficult to interact socially with his environment [5].

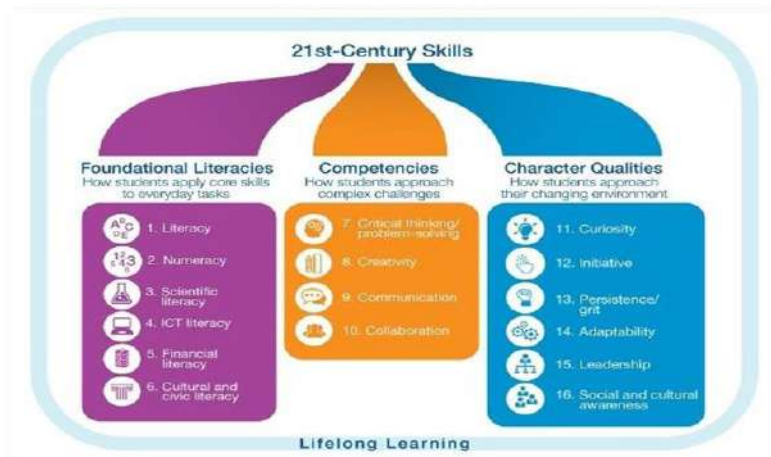
The concept of society 5.0 was born as a form of resolution to the emergence of various transformations as a result of the industrial

---

<sup>108</sup> Sebelas Maret University

revolution 4.0 which is characterized by the use of modern technology. The concept of society 5.0 which is characterized by humanism has placed the human role as the main controller of modern technology. For this reason, the characteristics of human resources in the 5.0 community era are people who are able to solve various challenges and social problems by utilizing various modern technological innovations but still puts humans as the main component.

The era of the 21<sup>st</sup> century which is characterized by the rapid development of information technology requires human resources with various domains, various skills and literacy, so that they are able to face opportunities and challenges in uncertainty and they can solve various complex problems. Human resources in the 21<sup>st</sup> century require the support of soft skills and hard skills whose essence includes four basic skills known as the "Four Cs" including: critical and problem solving, collaboration, creative, and communication [9]. 21<sup>st</sup> century human resources have at least six literacy including: technology literacy, scientific literacy, financial literacy, numerical literacy, cultural literacy and citizenship and cultural literacy. [6] states that face the challenges of the 21<sup>st</sup> century need four dimensions: knowledge, skills, character, and meta cognition. 21<sup>st</sup> century skills are presented in Figure 1.



**Figure 1: 21<sup>st</sup> Century Skills**

Based on this description, it can be concluded that although modern technology is the main character, scientific attitudes are still

important to be developed, so that humans are not enslaved by technology but instead humans are the controllers of technology. In order to realize 21<sup>st</sup> century, human resources that hold technology, but are still humanist. The values of a positive attitude need to be developed. This is supported by Saavendra and Opfer (2012) stated that competence of 21<sup>st</sup> century can be manifested in the form of knowledge, skills, and application of attitude values in life. Thus, it mean that the prospect of science education will be very strategic for future. The importance of science for technological development is reflected in the motto forward by Edward Teller that "today's science is tomorrow's technology"

Science education with its the nature of learning scientific and its of the characteristics has the strong potential to empower students' scientific attitudes. A scientific attitude that is continuously grown will become a habit that will crystallize in a person to form a character and than applied in real life. In order to anticipate era of society 5.0, the implementation of various models and strategies of science learning that oriented to science process skills, it is believed can foster students' scientific attitudes. This article discusses the potential of science education in developing students' scientific attitudes.

In order to prepare students to face the opportunities and challenges of the society 5.0 era as well as to answer three questions:

1. What is the reason for the concept of society 5.0 in the context of the 4.0 industrial revolution era?
2. What is the role of science education in building the character of human resources who have scientific attitude values?
3. What is the potential of science education in empowering scientific attitudes in the context of science learning?

## **Discussion**

### **Science Education**

Science education can be seen as a way of thinking, a way of investigating, and a way of knowing (a body of knowledge) [24], [8], [44]. Science is defined as a body of knowledge that is formed and obtained through a process of inquiry (discovery) [10], [18], [45]. This is relevant to the notion of science contained in the science education curriculum that science is defined as science that deals with how to find out information about the universe scientifically and systematically, so that science is not only an assignment or a collection of knowledge in the form of concepts, facts, and principles but is a process of discovery or inquiry [20].

As stated in the Regulation of the Minister of Education and Culture No. 57 of 2014 Article 5 Paragraph 2 [20]. The purpose of science education is to develop students' attitudes, knowledge and skills as the basis and strengthening of abilities in the life of society, nation and state. This is reinforced in the Regulation of the Minister of Education and Culture No. 37 of 2018 that the purpose of learning science includes three aspects namely: knowledge, skills, and attitudes [19]. In the context of graduate competence, it is explicitly stated in Permendikbud No. 20 of 2016 concerning graduate competency standards which states that graduate competency standards include cognitive, psychomotor, and affective aspects [20].

The development of three dimensions (cognitive, psychomotor, affective), is very relevant to the nature of science education where science is defined as: scientific products, scientific processes, and scientific attitudes [4]. Science as a scientific product can be in the form of facts, concepts, principles, propositions, laws, postulates, or theories. Science as a process is defined as a way of recognizing and connecting between theories and as a basis for scientific thinking and acting. Science as a scientific attitude, meaning that attitude values as a scientist grow after doing a series of scientific work [21], [46]. Based on the description above, it can be stated that according its the meaning, purpose, and essence, science education is very relevant to be used for the development of students' scientific attitudes.

### **Scientific Attitudes**

In the context of science learning, what is meant by the dimension of attitude (affective) is a scientific attitude, namely the attitude and behavior of a scientist in carrying out a series of scientific work including: brave and polite in asking questions, daring in opinion and arguing, caring for the environment, able to work together, diligently, innovative and creatively, disciplined, honest, objective, critical, and optimistic [11]. Scientific attitude is also interpreted as a way of acting based on feelings and thoughts during scientific practice which is needed when someone understands a natural phenomenon so that rational thinking is possible [27].

Based on the description above, it can be concluded that scientific attitudes are not built separately from the domains of student, but are integrated with the knowledge and skills domains. For this reason, building a scientific attitude must be in line with the development of knowledge and skills in learning, so that the three

domains of students can develop as a whole. The relationship and influence between the three domains of students has been proven in various scientific researches. Results research showed that there a relationship between the scientific attitudes and cognitive domain [1], curiosity affects various aspects of learning such as: 1) interest and learning outcomes in science, asking questions, finding out and scientific investigations [37], [13], [47], [17], [48], [16], [22]. 2) motivate to make empirical observations and solve everyday problems [31], [40], [3], [23]. 3) activeness and deep understanding of knowledge [35], [43], [30]. 4) improve critical and creative thinking [14]. Various research results also show that the development of scientific attitudes can have positive effects including: 1) being able to encourage individuals to be successful in the field of work and in socializing in society [12], [34], [33]. 2) facilitate work relations and tasks [15]; 3) able to accept the differences of others [25]. However, the fact is that the development of scientific attitudes in science learning tends to be neglected [28], [36], [26].

### **The Potential of Science Education in Building Students' Scientific Attitude**

Modernization is a global phenomenon that has become a growing trend in current industrial revolution era. The phenomenon of the transformation from traditional society to modern society which requires changes in culture, values and norms as well as mental elements of the perpetrators [. According to [38]. the change from traditional society to modern society is the most spectacular change, because it can affect all aspects of people's lives. The use of modern technology is able to fade the values of the social behaviour of society such as: loss of empathy towards others, low attitude of caring for the environment, fading of social interaction, increasing individual and selfish attitudes, etc.

Of course we agree with the motto that “a country without technology is a setback, but technology without good management will be very dangerous”. Departing from this, society 5.0 was born as a counterweight to the use of modern technology. In current digital era, the use of modern technology is very vital, but keep in mind that technology is not everything because humans still have to be the main component as controllers. This is relevant to the statement of Bill Gates and Nadiem Makarim that: “Technology is just a tool. In terms of getting the kids working together and motivating them, the teacher is the most important”. Referring to the statement above, the existence

of science education most important thing in the era of society 5.0. The important role of science education in building the students' scientific attitudes as a counterweight to the rapid of digital-based innovation that tend to override the social values in society.

Constructivism as the basis of science education where the concepts' discovery is obtained through active participation by carrying out a series of science process skills such as observation, experimentation, investigation using the scientific method. Knowledge is built when a person engages in dialogue or socializes and is active in investigation [29]. This is relevant to the nature of science as a body of knowledge that is built and obtained through a process of inquiry that contains the meaning of investigation [10], [18]. There are three activities that characterize inquiry, namely: 1) seeking and finding; 2) ask questions as a result of observing a natural phenomenon; 3) mental processes that explore thinking activities systematically, logically, critically, and encourage creativity. When someone learns science through a series of science process skills in order to find concepts, there scientific attitudes such as discipline, responsibility, patience, tenacity, hard work, honesty, respect for others, etc. will be built. Base on the explanation, it can be concluded that science education has great potential in developing students' scientific attitudes. Furthermore, how can it be implemented in learning? [42] said that one way to develop 21<sup>st</sup> century skills is through the implementation of science learning that allows students to be active and have a scientific attitude. Of course, the use of conventional strategies does not guarantee the realization of this pupose. Implementation of various models and strategies of science learning which oriented to science process skills such as: discovery learning, inquiry learning, problem-based learning, project-based learning and scientific approach which includes observing, questioning, reasoning, trying, communicating activities as mandated in the science curriculum, it is believed, can foster a scientific attitude in students [45].

## **Conclusion**

Based on the description above, it can be concluded that:

1. The era of society 5.0 that emphasizes the humanist aspect was rising as a counterweight to the use of modern technology which is a hallmark of the era of the industrial revolution 4.0.
2. Science education has a very strategic role in building human resources' character who have scientific attitude such as:

- curiosity, responsibility, discipline, honesty, hard work, tenacity, etc., so that they are able to solve problems by utilizing technological innovations.
3. Building a scientific attitude can be done through the implementation of scientific approach and various science learning models that are oriented inquiry as well as learning methods that emphasize science process skills are believed to be able to build students' scientific attitudes.

## References

- [1] Ahyani & Astuti. (2014). Cognitive Behavior Therapy dalam Memperkuat Empati pada Remaja dengan Perilaku Agresif. *Humanitas*, Vol. 11-2. 121-130. *Jurnal Penelitian, Keilmuan Psikologi. Fakultas Psikologi Univeristas Muria Kudus. Jawa Tengah*
- [2] Airlangga Hartarto. (2021). *Memasuki Era Society 5.0 Membangun Talenta Digital dan Meningkatkan Literasi Digital*. Jakarta: Kementerian Koordinator Bidang Perekonomia.
- [3] Anwar, H. (2009). Penilaian Sikap Ilmiah Dalam Pembelajaran Sains. *Pelangi Ilmu*, 2(5).
- [4] Arrend, R.I. (2006). *Learning to Teach*. Yogyakarta: Pustaka Pelajar.
- [5] Asta, Derina. (2019).—12 Penerapan Self Control Dalam Modifikasi Prilaku, <https://dosenpsikologi.com/penerapan-self-control-dalammodifikasi-perilaku>.
- [6] Bialik,M., Bogan,M.,Fadel,C., and Horvathova, M. (2015). *Character Education for The 21<sup>st</sup> Century: What Should Students Learn?*. Boston: Center for Curriculum Redesign.
- [7] Bowering M, Leggett B M, and Harvey M. (2007). Opening up thinking: reflections on group work in a bilingual postgraduate program Intern. *Journal of Teach. and Learn. in Higher Edu*. 19 2105-116.
- [8] Chiapetta, E.I and Thomas, R.K.J. (2010). *Science Instruction in The Middle and Secondary School: Developing Fundamental Knowledge and Skills*. 7<sup>th</sup>Edition. Boston, USA: Allyn Bacon.
- [9] Chiruguru, Suresh. (2020). *The Essential Skills of 21<sup>st</sup> Century Classroom (4Cs)*. <https://www.researchgate.net/profile/Suresh-Chiruguru/project/The-role-of-4Ss-Critical-Thinking-Creative-Thinking-Collaboration-and-Communication-in-the-21st-CenturyClassroom/attachment/5e752c06cfe4a7809f89c6ab/A>



[S:871265481027585@1584737286486/download/The+Essential+Skills+of+21st+Century+Classroom.pdf](https://doi.org/10.30605/S:871265481027585@1584737286486/download/The+Essential+Skills+of+21st+Century+Classroom.pdf).

- [10] Cimer,A. (2007). Teaching in Science: A Review of Literature. *Journal of Turkish Science Education*, 4(1), 21-43.
- [11] Depdiknas. (2003). Undang-undang RI No.20 Tahun 2003 tentang sistem pendidikan nasional. Jakarta: Depdiknas.
- [12] Donia, M. B. L., O'Neill, T. A., & Brutus, S. (2018). *The longitudinal effects of peer feedback in the development and transfer of student teamwork skills*. Learning and Individual Differences, 61, 87-98.
- [13] Ekawati, Tiwi (2017) *Pengaruh Kompetensi Profesional Guru Terhadap Efektivitas Pembelajaran Di MTS Aulia Cendekia Palembang*. Skripsi UIN Raden Fatah Palembang (Tidak diterbitkan).
- [14] Fadilah, I. Dan Kartini. (2019). Identifikasi Sikap Rasa Ingin Tahu Siswa Terhadap Pembelajaran Fisika di MAN 1 Batanghari. *Sukma: Jurnal Pendidikan* 3(1): 217-231.
- [15] Isjoni. (2010). *Pembelajaran Kooperatif: Meningkatkan Kecerdasan antar Peserta didik*. Yogyakarta : Pustaka Pelajar.
- [16] Jablon, J. y Wilkinson, M. (2006). Using Engagement Strategies to Facilitate Children's Learning and Success. *Journal of the National Association for the Education of Young Children*. Recuperado de <http://journal.naeyc.org/btj/200603/jablonBTJ.pdf> el 7-01-2009.
- [17] Jirout, J. And Klahr, D. (2012). *Children's scientific curiosity: In search of an operational definition of an elusive concept*. Developmental review 32 (2012): 125-160.
- [18] Kabba,E. (2009). Based Science Instruction: Teaching Science for Understanding. *Journal of Research in Science Teaching*, 39(5), 410-422.
- [19] Kemdikbud. (2018). *Permendikbud Nomor 34 Tahun 2018 Tentang Standar Nasional Pendidikan Sekolah Menengah Kejuruan/Madrasah Aliyah Kejuruan (Standar Proses)*. Jakarta: Kemendikbud.
- [20] Kemendikbud. (2014). *Diklat Guru Dalam Rangka Implementasi Kurikulum 2013*. Jakarta: Kemendikbud.
- [21] Khalik, Abd-El, Fouad, Leder N.G, and Le, An-Phong. (2008). Representations of Nature of Science in High School Chemistry Textbook Over The Past Four Decades. *Journal of Research in Science Teaching*, 45(7), 835-854.
- [22] Litman, J.A., & Jimerson, T.L. (2004). Curiosity as a feeding of deprivation. *Journal of Personality Assesment*, 80:75-86.

- [23] Litman, J.A. and Pezzo, M.V. (2007). *Dimensionality of Interpersonal curiosity. Personality and Individual Differences*. 44.
- [24] Liu, A.Y. and Lederman, N.G. (2007). Exploring Propective Teachers, Worldview and Conceptions of Nature of Science. *International Journal of Science Education*, 29(10):1281-1307. DOI: [10.1080/09500690601140019](https://doi.org/10.1080/09500690601140019).
- [25] Majid, A. (2013). *Strategi Pembelajaran*. Bandung : Remaja Rosdakarya.
- [26] Marati.S. (2021). *Identifikasi Sikap Ingin Tahu Siswa Kelas VIII Pada Materui Pencemaran Lingkungan Di SMPN 1 Gatak Kabupaten Sukoharjo*. Universitas Sebelas Maret. (Skripsi: Tidak Diterbitkan)
- [27] Meenakshi, C. and Vasimalairaja, M. (2016). Scientific Attitude Among Secondary School Students. *Bi-Annual Journal in Education*, 3(1), 133-134.
- [28] Megawati. (2018). Pentingnya Pengakomodasian Pengalaman Belajar Pada Pembelajaran IPA. *Jurnal Tunas Pendidikan*, 1(1), 21-30.
- [29] Moll, L.C. & Gonzales, N., (1994). Lesson From Research with Language Minority Children. *Journal of Reading Behaviour*, 1994 26(4):439-456.
- [30] Mussel, P., Spengler, M., Litman, J.A. and Schuler, H. (2012). Development and Validation of the German Work-Related Curiosity Scale. *European Journal of Psychological Assessment* 2012 28(2):109-117.
- [31] Pluck, G. and Johnson, H. (2011). Simulating Curiosity to Enhance Learning. *Educational Science and Psychology*, 19(2).
- [32] Pratiwi, A, Cari, C, dan Aminah, N.S. (2019). Pembelajaran IPA Abad 21 dengan Literasi Sains Siswa. *Jurnal Materi dan Pembelajaran Fisika (JPMF)*, 9(1), 34-42.
- [33] Putranto, N. A. R., and Woods. P. (2016). Comparison Indonesian and Australian Students' Cultural Intelligence and Attitude towards Teamwork: Case study of Institut Teknologi Bandung and Griffith University. *Sains Humanika* (8):1-2(2016) 59-67.
- [34] Robles, M. M. (2012). Executive perceptions of the top 10 soft skills needed in today's workplace. *Business Communication Quarterly*, 75(4), 453-465.
- [35] Rozak A., Hasannudin, Rusli, dan Muhammad, A. (2020). Hubungan Sikap Ilmiah Dengan Hasil Belajar IPA Peserta Didik

- Kelas VII SMPN 33 Makasar. *Jurnal IPA Terpadu*, 4(1), 52-62.hsdkk, 2020.
- [36] Rusmana, A.N. dan Wahidah, S.K. (2016). *Aplikasi Hakikat Sains dalam Perencanaan dan Pengelolaan Pembelajaran IPA di Indonesia : Sebuah Kajian Literatur*. Konferensi ICES IAIN Walisongo.
- [37] Sari,L. dan Firman. (2019). Pengembangan Model Pendidikan Karakter Terintegrasi Pembelajaran IPA Sekolah Dasar. *Jurnal Ilmu Pendidikan*, 1(3), 270-279.
- [38] Schoore, J.W. (1988). *Modernisasi: Pengantar Sosiologi Pembangunan Negara-negara Berkembang*. Jakarta: Gramedia.
- [39] Sulistyorini,Z.B. (2021). Dampak Penggunaan Gadget Terhadap Pembentukan Tingkah Laku. *Jurnal Exponensial*, Vol.2(1).
- [40] Sulthon, S. (2017). Pembelajaran IPA yang Efektif dan Menyenangkan bagi Siswa MI. *Elementary: Islamic Teacher Journal*, 4(1). <https://doi.org/10.21043/elementary.v4i1.1969>.
- [41] Suradisastra, K. (1992). *Pendekatan Sosiologis Untuk Rakyat Menuju Masyarakat Industri Peternakan di IBT*. Proceeding Agroindustri Peternakan di Pedesaan. BPT Ciawi Bogo
- [42] Tarihoran, E. (2017). Guru Dalam Pengajaran Abad 21. *SAPA- Jurnal Kataketik dan Pastoral*, 4(1), 46-58.
- [43] Taylor,L. and Pearson, J. (2011). Improving Student Engagement. *Current Issues in Education*, 14(1).
- [44] Tillery, B.W., Enger, E.D., Ross, F.C. (2012). *Integrated Science*. New York: The Mc Graw Hill Companies.
- [45] Trowbridge and Bybee. (1990). *Becoming a Secondary School Science Teacher*. Ohio: Merryl Publishing Company.
- [46] Waldrip, B., Prain, V., and Corolan. (2010). Using Multi-Model Representation to Improve Learning in Junior Secondary Science. *Research Science Education*. 2010;40:65-80. DOI: 10.1007/s11165=009-9137-6.
- [47] Yasar,O., Maliekal,J., Veronesi,P., and Little, L.J. (2017). The Essence of Scientific and Engineering Thinking and Tools to Promote it. *ASEE (American Society for Engineering Education)*, 1-15. <https://peer.asse.org/28966>.
- [48] Zion, M. and Sadeh, I. (2007). Curiousitu and Open Inquiry Learning. *Journal of Biological Education*, 41(4), 162-169.

# The Implementation of Pop Culture as Teaching English Media in Society 5.0

Sudiran<sup>109</sup>

## Introduction

Teachers in the era of society 5.0 must have the competence to use digital media and think creatively. Teachers play an important role in producing graduates who have the competencies required by Society 5.0 [1]. They are expected to be able to improve student learning outcomes by utilizing various sources of information as subject matter. Sources of information that can be used as a source of learning can be obtained from many applications such as Instagram, Facebook, Vlogs, Twitter, and others. The application has a lot of popular cultural content such as music, films, television, sports, comics, magazines, novels, and others that can be used as teaching media.

In education, society 5.0 is expected to be able to produce students who have high competence and mastery of scientific disciplines [2]. Society 5.0 can innovate in the fields of science and technology so that it can make efforts to improve the quality of education. Through Society 5.0, educational actors can bridge social and educational problems so that solutions are found that advance human civilization. Society, in general, cannot avoid the presence of increasingly advanced technology. In this era of society 5.0, humans need to formulate solutions to economic and social problems. These two problems need to be solved systematically and integrated both in physical and virtual spaces in the current 4.0 industry.

Society 5.0 can overcome various kinds of social problems by using various innovations that grew in the era of the Industrial Revolution 4.0. As it is known, the presence of the Industrial Revolution 4.0 is marked by the emergence of internet technology for various things (Internet of Things), artificial intelligence (Artificial Intelligence), large-capacity data (Big Data), and robots. All of them exist to improve the quality of human life. In this case, Society 5.0 uses advanced technology to assist humans in carrying out their daily tasks [3]. Society 5.0 can also be interpreted as a concept about a society that can solve human problems by utilizing technology.

---

<sup>109</sup> University of Muhammadiyah Malang.

Society 5.0 upholds human values that harmonize economic progress and solve social problems through a system that combines cyberspace and physical space [4]. The development of information and communication technology has resulted in drastic changes to society and education. The presence of Society 5.0 is expected to be able to solve various social and educational problems by integrating the innovations of the Industrial Revolution 4.0 marked by IoT, big data, AI, robotics, and e-commerce. The community is required to adapt to Society 5.0 by developing skills such as communication, leadership, and reading skills [5].

As educators in the era of society 5.0, teachers must have skills in the digital field and think creatively. In the era of society 5.0, teachers are required to be more innovative and creative in teaching in the classroom. Teachers must be able to integrate the Internet of things (IoT), Artificial Intelligence (AI), and Big Data into the learning process to improve student learning outcomes. They need to master 21st-century skills, namely creativity, critical thinking, communication, and collaboration.

The development of digital media helps teachers to design teaching media. Learning design needs to pay attention to culture and interactive media [6]. Social media such as Facebook and Youtube can be used by teachers as a source of information that can be transformed into educational media. This is because social media provides a variety of content such as music, films, and photos of public figures. Such content is part of popular culture material that can be used as educational media so that the learning process can attract students' attention, and provide them with a pleasant learning experience.

Teachers need to improve their skills to be able to use social media as a learning medium. Even young people believe that education can use social media such as Facebook and Instagram to facilitate learning activities [7]. This is because social media has become part of people's lives, especially users who are all classified as young people.

According to Guy [8], popular culture can be defined as products and cultural meanings that complexly influence each other. In popular culture, products can be defined as everything that is produced by humans either manually or using modern technology which aims to create objects that can fulfill human desires such as t-shirts, shoes, jewelry, entertainment, watching sports competitions, films, magazines, and so on. etc. While the meaning is a concept that results from the association between two or more objects.

Popular culture products include books, magazines, films, television, computer games, music, the internet, and others [9]. These products have become a part of everyone's life, even school children. Nowadays it is very difficult to find children or high school students who are not familiar with music, computers, the internet, or online games. These objects have become an inseparable part of the lives of teenagers. Television as part of popular culture plays an important role in the development of students' personalities and knowledge because television provides extensive entertainment and information that can increase their knowledge [10].

Meanwhile, learning English is considered boring by students in school. They think English lessons are too difficult and the material is not interesting so they feel frustrated. To overcome this, teachers need to find the right solution so that English lessons become a subject that is liked and in demand by many students at school. A technique to increase students' interest in learning English is that teachers use popular culture products as learning English media. Using popular culture because of these products are widely known to students, they even enjoy them as entertainment and consumption materials. Even enjoying and using popular culture products to explore important concepts in learning has become a trend among high school students [11].

There are several reasons for using popular culture products as a medium for teaching English, among others, 1) popular culture is an inseparable part of the lives of most high school students, 2) students learn to become critical users of popular culture including developing the ability to appreciate media news, 3) Popular culture products are objects that are common and enjoyed by most students [12].

This study aims to describe the teacher's strategy to apply popular culture as for teaching media in the era of society 5.0. In this study, researchers focused on music and other media images that attracted students' attention. The use of music and pictures of popular media is very important because some subjects in schools now use popular culture products as variations in learning activities according to the curriculum [13]. Many educators and researchers have investigated the relationship between education and popular culture to promote learning that reinforces values and social empowerment among students [14].

This study used qualitative methods, and data collection was carried out with the techniques of 1) observing teacher activities

while teaching in class, 2) interviewing teachers at school, and 3) analysis of educational media produced by the teacher as a document. Unstructured interviews or open-ended questions were used to collect data from informants and to obtain information about the design and implementation of English language teaching media. Observations were also used to obtain information about some of the challenges that affect the design of innovative English teaching materials to be implemented in schools. This study also utilizes documentation as a data collection method to obtain information about teacher competencies in designing innovative English learning media.

This study interviewed five teachers as informants to collect data. They were interviewed about some of the factors or criteria they considered for designing English teaching media, and their representation of the main objectives of foreign language teaching. To maintain the confidentiality of the informants, this study disguised the names of the informants by writing their initials.

## **Discussion**

Before teaching, the teacher must make sure that the teaching media contained popular culture. Teaching media that contains popular culture must have objects that can attract students' attention so that they can understand the lesson easily. The use of popular culture as a learning medium involving social media is part of the learning process by the characteristics of society 5.0. The teacher has acknowledged the application of instructional media containing popular culture.

“The teaching media that I have developed uses popular culture material because it can make students focus on the lesson and improve their optimal learning outcomes that I function as a facilitator” (Teacher / ETJ).

Teaching media that uses popular culture has several characteristics, among others, attracting students' attention, giving pleasure to students, and being known by many students. With these three characteristics, popular culture-based teaching media can improve students' understanding of learning the subject matter. The effectiveness of learning through popular culture-based teaching media has been expressed by one teacher.

“The teaching media that I developed use popular culture material because it stimulates students to learn more actively. For example, I teach material about the simple present tense, I show

interesting pictures in power-point and show an animated video first then ask students questions, or ask them to discuss with their friends. If anyone doesn't know, I will appoint their friends to explain the answers to their questions" (Teacher/ SWP).

Teaching English is carried out to develop student's abilities in English language skills which include listening, reading, speaking, and writing skills in English. The developed ability to master these English skills has been stated by the teacher.

"The ability that must be mastered by students from the popular culture-based learning media that I developed is to improve English language skills which include, listening, reading, speaking, and writing." (Teacher/ ETJ).

The listening subject matter can be in the form of songs or popular music. The purpose of using popular songs as teaching listening media is to improve students' ability to capture meaning in popular songs or music. Like the popular music "Whatever Will Be Will Be" created by Doris Day which the teacher has used as a medium for listening lessons. The lyrics of the song are as follows.

"Whatever Will Be Will Be Que Sera Sera"

When I was just a little girl

I asked my mother, what will I be

Will I be pretty, will I be rich Here's what she said to me.

Que Sera, Sera,

Whatever will be, will be

The future's not ours, to see Que Sera, Sera What will be, will be.

When I was young, I fell in love

I asked my sweetheart what lies ahead Will we have rainbows, day after day Here's what my sweetheart said.

Que Sera, Sera, Whatever will be, will be

The future's not ours, to see Que Sera, Sera What will be, will be.

Now I have children of my own

They ask their mother, what will I be handsome, will I be rich I tell them tenderly.

Que Sera, Sera, Whatever will be, will be

The future's not ours, to see Que Sera, Sera What will be, will be." (Day, 006)

After the students finished listening to the song that was played twice, they were asked to discuss the song by doing the tasks in groups until the lesson ends.



## Conclusion

Based on the results of the research above, it can be concluded that teachers have integrated social media and technology into classroom learning. The ability of teachers to integrate media and technology into the learning process shows that teachers are ready to enter the era of society 5.0. A teacher in the era of society 5.0 must be able to apply Industrial Revolution 4.0 technologies such as artificial intelligence (Artificial Intelligent), the Internet for various things (Internet of Things), large-capacity data (Big Data), and robotics (Robotic).

Teachers in the era of society 5.0 use social media as a means to develop learning media into teaching and learning activities. Social media has a variety of interesting information and entertainment and can be used as a learning medium. Information and entertainment from social media is popular culture material that is entertaining, fun, and already known by many people, including students. This makes the teaching media of popular culture have a useful value to improve learning outcomes.

The findings show that teachers have implemented English learning media that they developed from popular culture products. One of the popular culture materials that can be used as teaching media is music. The teacher uses popular music as a medium of learning. the song used as a teaching medium is entitled, "whatever will be, will be".

Music is a combination of lyrics and instruments. Lyric in music is a literary work, namely a poem or poem created by a poet. Meanwhile, the sound of instruments in music is a rhythmic strain created by musicians to produce a tone that is fun and entertains everyone. Both lyrics and musical notes are works of art created to fulfill people's need for entertainment.

## References

- [1] H. Wibawanto, Roemintoyo, and T. Rejekiningsih, "Indonesian Vocational High School Readiness Toward Society 5.0," *J. Educ. Res. Eval.*, vol. 5, no. 1, pp. 24–33, 2021, [Online]. Available: <https://ejournal.undiksha.ac.id>.
- [2] S. M. Sari, C. Fauzi, A. Yus, I. Gultom, and M. S. A. Lubis, "Society 5.0: Hots Learning of Sota (State of The Art," *Educ. J. Teknol. Pendidik*, vol. Vol. 5, no. 1, pp. 11–23, 2020, doi: DOI: 10.32832/educate.v5i1.2020.

- [3] C. B. Frey and M. A. Osborne, "The future of employment: How susceptible are jobs to computerisation?," *Technol. Forecast. Soc. Change*, vol. 114, no. C, pp. 254–280, 2017, [Online]. Available: <https://doi.org>.
- [4] Y. Shiroishi, K. Uchiyama, and N. Suzuki, "Society 5.0: For Human Security and Well-Being," *Computer (Long Beach. Calif.)*, vol. 51, no. (7), pp. 91–95, 2018, [Online]. Available: <https://ieeexplore.ieee.org>.
- [5] N. W. Sukraini, "Developing Students' Essential Skills in Preparation for Society 5.0," in *Prosiding Webinar Nasional IAHN-TP Palangka Raya 2020*, 2020, pp. 55–63, [Online]. Available: <https://prosiding.iahntp.ac.id>.
- [6] J. A. Engerman and R. F. Otto, "The shift to digital: designing for learning from a culturally relevant interactive media perspective.," *Educ. Technol. Res. Dev.*, vol. 2021, no. 69, pp. 301–305, 2021, [Online]. Available: <https://doi.org>.
- [7] R. Machfiroh, Sapriya, and K. Komalasar, "Indonesian Youth Readiness in Supporting Unlimited Education Society 5.0," *Adv. Soc. Sci. Educ. Humanit. Res. Vol. 418 2nd Annu. Civ. Educ. Conf. (ACEC 2019)*, vol. 418, pp. 529–533, 2020, [Online]. Available: <https://dx.doi.org>.
- [8] T. C. Guy, "Learning who we (and they) are: Popular culture as pedagogy," *Pop. Cult. Entertain. Media*, vol. 2007, no. 115, pp. 15–23, 2007, [Online]. Available: <https://doi.org/10.1002/ace.263>.
- [9] T. G. Morrison, G. Bryan, and G. W. Chilcoat, "Using Students-generated Comic Book in the Classroom," *J. Adolesc. Adult Lit.*, vol. 45, no. 8, pp. 758–767, 2002.
- [10] Sudiran, "Television as Popular Culture Media and Parental Attention and Their Correlation to the Students' Motivation to Choose Major," *Sino-US English Teach.*, vol. 12, no. 5, pp. 387–396, 2015, doi: 10.17265/1539-8072/2015.05.008.
- [11] M. Ronayne, J. Shayne, and J. Nguyen, "Meeting in the Middle: Making Use of Popular Culture in the Classroom," *Pedagog. Hum. Sci.*, vol. 2, no. 1, pp. 22–32, 2012, [Online]. Available: <https://scholarworks.merrimack.edu/phs>.
- [12] T. G. Morrison, G. Bryan, and G. W. Chilcoat, "Using students-generated comic books in the classroom," *J. Adolesc. Adult Lit.*, vol. 45, no. 8, pp. 758–767, 2002.
- [13] P. A. Duff, "Pop Culture and ESL Students: intertextuality, identity, and participation in classroom discussions.," *J. Adolesc.*

- Adult Lit.*, vol. 45, no. 6, pp. 482-487 \_\_\_, 2002, [Online]. Available: <http://www.jstor.org>.
- [14] G. Sfeir, "Critical Pedagogy Through Popular Culture," *Educ. Matters*, vol. 2, no. 2, pp. 15-25, 2014, [Online]. Available: <https://journalhosting.ucalgary.ca>.
- [15] D. Day, "Whatever Will Be Will Be Que Sera Sera," [www.metrolyrics.com/que-sera-sera-lyrics-doris-day.html](http://www.metrolyrics.com/que-sera-sera-lyrics-doris-day.html), 2006. [www.metrolyrics.com](http://www.metrolyrics.com).

# Characteristics of Learning Facing the Era of Society 5.0

Sulastri Rini Rindrayani

## Introduction

Indonesia is currently facing two conditions, namely the era of 4.0 and the era of society 5.0. The Revolutionary Era of Society 5.0 is oriented towards the development and utilization of technology for a better society. The realization of this concept leads to the achievement of the sustainable development goals (SDGs)[1]. Concept 5.0 explains how there is a revolution in society that uses technology by considering human and humanities aspects. This industrial revolution is marked by the development of Artificial Intelligence, Robotics, Automation, Big Data, and the Internet of Things. What is the basic foundation of Society 5.0 is the principle of balance that seeks to harmonize economic development (both from energy needs, food needs, welfare equality, etc.) with the resolution of social problems (impacts on the surrounding environment, industrialization that affects employment opportunities)., the quality of human resources, etc.) in order to be well integrated [2][3].

The results of research by M. Ghofirin, and N. Primasari prove that Interpersonal skills are increasingly important, especially the leadership dimension. Therefore, the development of digital- based accounting student learning such as case studies, Class Polling and Surveys, discussion groups, and others is considered to be adaptable to prepare them to become accountants in the eraofsociety5.0. deals with ways to become human beings and creative, innovative and sustainable communities.[4].Through the concept of society 5.0, people's lives are expected to be more comfortable and sustainable .[5] Society 5.0 will have an impact on all aspects of life starting from health, urban planning, transportation, agriculture, industry and education[6] Era 5.0 can be realized if technological capabilities are strong, human resources are competent in their respective fields to carry out their profession digitally.[2]

In the educational world, the existence of teacher roles and functions is one of the most significant factors. Teachers are an essential part of the teaching and learning process, both on formal and informal educational pathways. Therefore, in every effort to improve the quality of education in the homeland, it cannot be removed from various matters relating to the teacher's existence[6] In the world of education, teachers have an important role in producing graduates

who are able to adapt and compete with the 5.0 era. In facing the era of society 5.0, the world of education plays an important role in improving the quality of human resources. [1] Education must be able to facilitate and optimize the potential of students to be equipped to navigate the opportunities and challenges of the industrial revolution 4.0 and society 5.0. [7]. The National Education Association, 2017 states that students are not sufficiently equipped with the ability to read, write and count or better known as "Tree R" (reading, writing, arithmetic), but also need to be equipped with global community competencies or also called 21st century skills, namely by providing various communicative, creative, critical thinking, and collaborating learning models or known as the "Four Cs", namely communicators, creators, critical thinkers, and collaborators[8][1]

Based on the explanation above, teachers must have the necessary competencies to face the 5.0 era. These competencies include (1) educational competence, (2) competence for technological commercialization, (3) competence in globalization, (4) competence in future strategies, (5) counselor competence,[8]. In the opinion of Wahyuni and Latif, teachers in facing the industrial era 5.0 must have the ability to: be friendly with technology, collaborate with others, be creative and take creative risks, have a good sense of humor, and teach holistically (holistic in learning and learning theory).[9]. Meanwhile, according to Irawan, there are five main skills possessed by the young generation of the Indonesian nation, namely: complex problem solving, social skills, process skills, system skills, and cognitive abilities .[7]. Therefore, teachers in teaching must implement erab 5.0 competencies so that students have the expected 5.0 skills.

Based on the problems above, this article aims to provide a description of how the characteristics of learning that can be done by teachers in dealing with era 5.0. Learning that is in accordance with the era of society 5.0, if done well by the teacher, will have an impact on students having competencies that can compete in the era of society 5.0

## **Discussion**

### **The concept of Era society 5.0**

Society 5.0 is an era initiated by the Japanese government. The concept of human-centered and technology-based society. In the concept of "Society 5.0", humans will play a bigger role by transforming big data into a new wisdom, which can create opportunities for humanity to achieve a meaningful life. [10]The

concept of 5.0 led to the incorrect assumption that the number 5 represents a continuation of the Fourth Revolution. Society 5.0 makes use of technology that has been developed to address issues that have arisen (in part) as a result of the Fourth Revolution, such as alienation of social relations, digital inequalities that lead to socio-economic inequalities, and the use of fragmented technology in the context of shared prosperity.[11] Society 5.0 is a concept that states that technology will coexist with humans to improve the quality of life in a sustainable manner [12].

Society 5.0 is the answer to the challenges that arise due to the era of the industrial revolution 4.0 which was accompanied by a disruption marked by a world full of turmoil, uncertainty, complexity, and ambiguity. Society 5.0 is a society that can solve various challenges and social problems by utilizing various innovations that were born in the era of the industrial revolution 4.0 such as the Internet of Things (internet for everything), Artificial Intelligence (artificial intelligence), Big Data (large amounts of data), and robots to improve the quality of human life [3]. The era of society 5.0 is an attempt to solve the problems caused in the 4.0 era. The Society 5.0 era implements technology in the industrial revolution 4.0 by considering the humanities aspect to solve various sustainable social problems. The era of society emphasizes that technology and its functions have become part of human life, while in the industrial era 4.0 technology is used as a tool to access information.

### **Learning Era Society 5.0**

Society 5.0 will have an impact on various areas of life, especially in the field of education. The impact of society on the field of education, especially teachers play a strategic role in producing graduates who have regulatory competence, skills and attitudes that can adapt to global conditions. The teacher's role will be realized through the learning process. The quality of learning carried out by teachers can be seen from the planning, implementation and evaluation. Learning planning can be seen in the RPP which contains materials, methods, media and evaluation tools used in learning. The implementation of learning can be seen from the learning process. Has the student central method been used in the learning process

The learning process carried out by the teacher must be able to produce students who have skills[7] Among others: (1) Complex Problem Solving the ability to solve unfamiliar problems and the solution is not known in the real world (2) Social skills are the ability

to coordinate, negotiate, persuasion, mentoring, sensitivity in providing assistance to emotional intelligence, (3 ) Process skills are abilities that consist of active listening, logical thinking, and monitoring self and the others, (4) System skills are the ability to be able to make judgments and decisions with cost-benefit considerations and the ability to know how a system is created and run. (5). Cognitive abilities are skills consisting of, among others: Cognitive Flexibility, Creativity, Logical Reasoning, Problem Sensitive Mathematical Reasoning, and Visualization. Other opinions that learning according to society 5.0 include (1) using various student-centered learning models (student center learning) actively, innovatively and creatively, (2) empowering information and communication technology (ICT)-based learning, and (3) playing a role important in improving the quality of learning by always paying attention to the characteristics of each student collectively [8]

### **Learning to face the era of society 5.0**

The era of global competition demands quality learning to provide facilities for students to develop skills, skills and abilities as capital to face challenges in global life. Therefore, from now on, the government has implemented the HOTS learning system [10] High Order Thinking Skills (HOTS) is a system of thinking by memorizing and re-describing the knowledge that has been obtained. This highest skill is a skill that can link, change, modify knowledge with the expertise that has been obtained so that it is useful for choosing alternative solutions in solving problems in certain conditions.[13] This concept is incorporated into education aimed at preparing superior human resources who are ready to welcome the industrial revolution. In the 21st century, human resources have the skills and expertise[13].

The application of HOTS learning begins with the preparation of a Lesson Plan (RPP) which can provide opportunities for students to think critically. In addition, the materials, methods, and media used in the learning process can encourage students to think critically. Halimah Siti's research results prove that HOTS learning with the HOTS approach, students in the learning stage have been able to actualize Bloom's Taxonomy theory, namely at the level of analyzing, evaluating, creating. Besides that, it can stimulate students to think critically[13] Students are able to think critically and quickly receive various information, think creatively in solving a problem using the knowledge they have, and make decisions in complex situations[10].

Several learning models can be selected and applied by teachers to develop critical thinking (1) inquiry learning, (2) discovery learning, (3) Project based learning, Problem based learning.[14] Inquiry learning according to Gulo is a series of learning activities that maximally involve all students' abilities to search and investigate systematically, critically, logically, analytically, so that they can formulate their own findings with confidence. Discovery learning, discovery learning model is defined as a learning process that occurs when students are not presented with information directly but students are required to organize an understanding of the information independently. Students are trained to get used to being a scientist (scientist).

They are not only consumers, but are also expected to play an active role, even as actors from the creators of science. Project-based learning is a learning model that has been widely developed in developed countries such as the United States. If translated into Indonesian, project-based learning means project-based learning. Project-based learning is an innovative learning model or approach, which emphasizes contextual learning through complex activities. The Problem Based Learning model is a learning model with a student learning approach to authentic problems so that students can construct their own knowledge, grow and develop more skills. high and inquiry, self-reliant students and increase self-confidence.[14]

The strategy used to increase meaningful learning towards society 5.0 should still refer to the learning concept launched by the UNESCO commission in the form of "the four pillars of education", namely ("learning to know") learning to know, ("learning to do") learning do something, ("learning to live together") learn to live together as a basis for participating and cooperating with others in all activities of human life, and ("learning to be") learning to be oneself (Delors, 1996).[8] Strategies can be applied to learning models that are more active for students, for example the use of more contextual, cooperative and collaborative learning models, inquiry, and problem-based learning so that learning is more interesting and meaningful.

Some of the optimal implementation of learning strategies can be done several things: (1) Utilization of various types of information and communication technology such as internet networks, electronic-based learning media, and the like are very necessary in supporting learning towards the era of society 5.0. (2) use of internet networks as a source Learning can encourage students to obtain information quickly, exchange information quickly with



various social media without having to face to face. (3) Teachers need to be aware of the differences between students: different levels of intelligence, different learning styles, and differences related to understanding the material understanding. In addition, teachers also use various teaching strategies to ensure that all students have a quality education.[8]

Educators may choose various learning models such as discovery learning, project based learning, problem based learning, and inquiry learning. These various models encourage students to build creativity and think critically. Learning in dealing with Society 5.0 during the Covid-19 pandemic can apply hybrid / blended learning.[1] blended learning is a learning that combines learning in the network (online) and face-to-face or outside the network (offline).

Applications to support blended learning [7][9]. The results of Setyowati's research prove that the use of a scientific approach with a problem based learning model in increasing the competence of attitudes, knowledge and skills in social studies learning [15] The research findings also prove that the scientific approach with a problem-based learning model (1) students can achieve complete learning on attitude competence. This combination is able to train students to show social attitudes. (2) This combination is able to train students in constructing new knowledge based on problems, (3) this combination encourages independent activities of students to conduct group discussions, collect information and collect reports. This model trains to express opinions, ask questions, answer, and present the results of their discussions. Students can create attractive product displays that can support group presentations.

### **Teacher Competencies in the era of society 5.0**

Five important components must be prepared for the era of society 5.0 (1) educational competence. Internet-based learning competence. (2) competence for technological commercialization. This means that teachers must have competencies that will bring students to have an entrepreneurial attitude with technology on the innovations of students, (3) competence in globalization, that is, teachers do not stutter about various cultures and are able to solve educational problems, (4) competence in future strategies in the sense of competence to predict exactly what will happen in the future and its strategy, by means of joint-lecture, joint-research, joint-resources, staff mobility, and (5) counselor competence, namely the competence of teachers to be able to understand that problems in the future

students, it is not only difficult to understand the teaching material, but also related to psychological problems due to the times.[14]

According to Nilasari, to produce quality resources, teachers must have: (1) be friendly with technology, meaning that changes and technological advances are responded positively, adapts, and always shares with colleagues or colleagues both successes and failures. (2) Cooperation (collaboration) with others, meaning that teachers must have a strong will to cooperate with others to learn from others. (3) creative and take the risk of creativity, meaning that teachers must be creative in learning, assigning student assignments and others and be ready to face the risks that arise. (4) having a good sense of humor means that laughter and humor are important skills to help and build relationships and relationships in life, (5) teaching as a whole (holistic) in various ways of learning and learning, meaning that teachers need to recognize individual students, their families, how to learn, for both the obstacles they experience, both personally and within their families..[9]

## **Conclusion**

In addition, teachers must have the competence of the Society 5.0 era, teachers must adjust learning according to the challenges of the Society 5.0 era. The learning era of society 5.0 emphasizes the central learning of students. Learning that can provide skills to students (1) complex problem solving, namely the ability to solve problems experienced in everyday life (real world), (2) social skills, namely the ability to coordinate, negotiate, persuasion, mentoring, sensitivity in giving assistance to emotional intelligence, (3) process skills are abilities consisting of active listening, logical thinking, and monitoring self and the others, (4) System skills are the ability to be able to make judgments and decisions with cost-benefit considerations and the ability to know how a system is created and run. (5) Cognitive abilities are skills consisting of, among others: Cognitive Flexibility, Creativity, Logical Reasoning, Problem Sensitivity, Mathematical Reasoning, and Visualization.

Society 5.0 era learning is central to students who can shape student competencies according to the society 5.0 era, namely the use of more contextual, cooperative and collaborative learning models, inquiry, and problem-based learning so that learning is more interesting and meaningful. Learning that encourages students to be active, think critically, collaboratively, innovatively and creatively include (1) inquiry learning, (2) discovery learning, (3) Project based

learning (4) Problem based learning. However, learning can be optimal other than because of the competence of the teacher, also because of the support of facilities and infrastructure available in schools. The role of the principal is especially important in understanding and adapting to the demands of education in the era of society 5.0.

## References

- [1] M. I. Kahar, Hairuddin Cjkka, and N. Afni, "Pendidikan era revolusi industri 4.0 menuu era society 5.0 di masa pandemi covid 19," *Modersi J. Stud. Ilmu Pengetah. Sos.*, vol. 2, no. 1, pp. 103–111, 2021.
- [2] U. Al Faruqi, "Survey Paper : Future Service in Industry 5 . 0," *J. Sist. Cerdas*, vol. 02, no. 01, pp. 67–79, 2019.
- [3] P. H. Putra, "tantangan pendidikan islam dalam menghadapi societ 5.0," *urnal Islam. unral ilmu-ilmu Keislam.*, vol. 19, no. 02, pp. 99–110, 2019.
- [4] M. Ghofirin and N. S. Primasari, "Procedia Business and Financial Technology Readiness to Face Society 5 . 0 Era , What Interpersonal Skill Does an Accounting Student Have?: An Evidence from Indonesia Procedia Business and Financial Technology," in *Procedia Business and Financial Technology. roceedings of the 2nd International Conference on Business and Management of Technology (ICONBMT 2020) -Part 2*, 2020, no., pp. 14–18.
- [5] K. P. Indonesia, "Kesiapan pendidik Indonesia menghadapi era society 5.0," *Edcomtech*, vol. 5, no. 1, pp. 61–66, 2020.
- [6] A. H. Wahyuna and S. Fitriana, "Teacher Professionalism and Educational Challenges of The," vol. 7, no. 2, pp. 53–63, 2020.
- [7] Edi Erawan, "Pelatihan blended learning sebagai upaya menghadapi Society 5.0," *Aksiologi J. Pengabd. Kpd. Masy.*, vol. 4, no. 2, pp. 190–198, 2020.
- [8] E. Suprayitno, "strategi meningkatkan citra pembelajaran ips YANG," vol. 01, no. 01, pp. 19–28, 2021.
- [9] S. Nilasari, "Pendidikan di Era Revolusi Industri 5.0 terhadap Disiplin Kerja Guru," in *Seminar Nasional Pendidikan Program Pascasarjana Universitas PGRI Palembang*, 2020, pp. 795–804.
- [10] Ramadhan P. Wibawa and D. R. Agustina, "Peran pendidikan berbasis Hingher Order Thinking Skills (HOTS) pada tingkat sekolah menengah pertama di era Society 5.0 penentu kemauan bangsa indonesia," *Equilibrium*, vol. 7, no. 2, pp. 137–141, 201AD.

- [11] Whedy Prasetyo, "Society 5.0 milenial generation: digital talents formula of global open government and smart cities," *J. Ris. Akunt. dan Bisnis Airlangga*, vol. 4, no. 2, pp. 623–643, 2019.
- [12] S. Sugiono, "Industri Konten Digital dalam Perspektif Society 5 . 0 Digital Content Industry in Society 5 . 0 Perspective," *J. Ilmu Pengetah. dan Teknol. Komun.*, vol. 22, no. 2, pp. 175–191, 2020.
- [13] S. Halimah, "Implementasi Pendekatan Hots ( Higher Order Thinking Skills ) Dalam Pembelajaran Pai ( Studi Pada Siswa Kelas X Di SMAN 2 Pasuruan Jawa Timur )," *Eval. urnal manaemen Pendidik. Islam*, vol. 5, no. 2, pp. 342–362, 2021.
- [14] I. Royani, "Peningkatan Kompetensi Guru Menuju Era Revolusi Industri 5.0," in *Prosiding seminar nasional pendidikan program pascasarjana universitas pgri palembang 10 januari 2020*, 2020, pp. 449–456.
- [15] R. Setyowati, E. Mulyani, and U. N. Yogyakarta, "Efektifitas pedekatan scientific dengan PBL dan problem solving untuk meningkatkan kompetensi dalam pembelajaran IPS," *Harmon. Sos. J. Pendidik. IPS*, vol. 3, no. 1, pp. 74–81, 2016.

# Prevention and Control of Non-Communicable Diseases Era Society 5.0

Sulistyaningsih<sup>110</sup>

## Introduction

Non-communicable diseases (NCDs) are a global public health problem, contributing to more than 85% of deaths in high-income countries, and 85% in low- and middle-income countries. NCDs kill 41 million people every year, equivalent to 71% of all deaths globally. Every year, more than 15 million people die from NCDs between the ages of 30 and 69 years; 77% of all NCD deaths occur in low- and middle-income countries [1]. NCDs are the cause of most deaths in Kuwait, Middle East [2]. Four main types of NCDs have accounted for more than 80% of all premature NCD deaths in 2019 namely cardiovascular diseases such as heart attacks and strokes (17.9 million people every year), cancer (9.3 million), chronic respiratory diseases such as obstructive pulmonary disease, chronic disease (COPD) and asthma (4.1 million) and diabetes (1.5 million) [1]. The four main NCDs have dominated disease patterns in Indonesia [3]. Meanwhile, breast cancer and cervical cancer are the two main causes of cancer death in women in Sub-Saharan Africa [4].

NCDs and NCDs risk factors have a close relationship with COVID-19 [5]. COVID-19-related mortality is greater among people with various NCDs, among others in India largely due to the burden of NCDs and risk factors especially obesity and diabetes. Individuals with coronary heart disease, heart failure, chronic respiratory, kidney or liver disease and cancer or their risk factors such as diabetes, hypertension, obesity, and other vascular risk factors have a greater risk of contracting infection and developing complications and death from COVID-19 [6].

NCDs are a chronic disease that results from a combination of genetic, physiological, environmental and behavioral factors. Poor socioeconomic status is independently associated with NCD risk factors [7]. Children, adults and the elderly are all susceptible to risk factors that contribute to NCDs, whether from an unhealthy diet, physical activity, exposure to secondhand smoke or harmful alcohol use. The high prevalence of NCD risk factors among Nigerian civil

---

<sup>110</sup> Universitas 'Aisyiyah Yogyakarta

servants includes inadequate fruit and vegetable intake and lack of physical activity. Biological risk factors were more common among women than among men because they were associated with an increased risk of abdominal obesity and being overweight or obese, but were protective against smoking and drinking. The risk of hypertension increases entering the age of 30 years. An increase in blood pressure is strongly correlated with an increase in blood sugar [8].

NCD control efforts mainly focus on reducing risk factors because the costs are low and risk factors are easier to modify. Smoking behavior is a risk factor associated with cardiovascular disease (32.6%) which is easier to treat than diabetes (6.1%) or cancer (2.1%). The risk factor for physical inactivity was mostly related to diabetes (14.6%) [2]. Metabolic risk factors contribute to the four main metabolic changes that increase the risk of NCDs namely increased blood pressure; overweight/obese; hyperglycemia (high blood glucose levels); and hyperlipidemia (high levels of fat in the blood). Other efforts for the prevention and control of NCDs are monitoring trends in NCDs and risk factors for NCDs, reducing the impact of NCDs on individuals and society, NCD management interventions (early detection, screening, timely treatment) and providing access to palliative care. NCD management interventions are very important to achieve the global target of 25% relative reduction in the risk of premature death due to NCDs by 2025, and the SDG target of a third reduction of premature deaths from NCDs by 2030. Collaboration of all sectors is needed to promote interventions to prevent and control NCDs [9].

The results of a scoping review of cohort studies indicate that the key to controlling the NCD epidemic is primary prevention and prognosis, which is based on surveillance and involves the systematic collection of high-quality data. This information is essential for future research recommendations, as well as public health policy. There are many studies that collect high-quality data that can be easily constructed to include various NCD. The results of this study can be useful for studying the life journey approach to NCD and its interactions [10].

Intervention management to prevent and control NCDs requires technology that is in accordance with the development and needs of the community. Society 5.0 focuses on applying technology in constant development and innovation driven by Industry 4.0 to solve human problems such as population aging, natural disasters, social

inequality, security, and improving people's quality of life. Society 5.0 enables the use of advanced technologies such as information technology, Internet of Things, robotics, artificial intelligence, and augmented reality in human life, health, and other fields of activity [11]. Society 5.0 balances the best interests of society as a whole, which involves solving social problems, with the best interests of individuals, which is an indication of a human-centered society [12]. The purpose of this discussion is to answer the problem of how to prevent and control NCDs in the Society 5.0 era. This discussion is important considering that the NCD epidemic continues to increase, while the prevention and control of NCDs using advanced technology is still limited and very much needed by the community.

## **Discussion**

Global trends, WHO and national health organizations recommend that e-health is the only appropriate procedure especially in the context of Society 5.0. WHO mentions the health system challenge (HSC), namely 1) insufficient resources, both human and material, which can be overcome by creating programs to optimize certain activities so that they can be carried out without human intervention (example administrative problems); 2) Lack of data or access to data, which can be overcome by using automatic recording of diagnostic test results, establishing an electronic medical documentation platform, and registering medical data; 3) Lack of monitoring the patient's condition, follow-up that can be done, among others, by using applications that are connected to medical devices to monitor patient health or empower patients automatically.

E-health includes several health services and information technology, such as electronic medical records that facilitate the exchange of patient data between health care entities (general practitioners, specialists, hospital teams, and pharmacists); telemedicine which includes all types of tests and measurements that do not require a patient visit to a specialist; medicine based on scientific evidence which includes a system that provides information about the appropriate treatment for a particular patient condition; consumer health care information technology that enables access to information on specific issues from the field of medicine; health knowledge management – specialized access to medical information; a virtual healthcare team that includes healthcare professionals who convey information about patients via digital devices [13]. The e-health concept will be discussed for the prevention and control of

NCDs and NCDs risk factors, including intelligent healthcare, digital health, smart healthcare, mHealth, telemedicine, multichannel interaction.

### **Intelligent healthcare**

Internet of Things (IoT) is the heart of Intelligent healthcare, which is very useful because of the accessibility of the internet all over the world. Intelligent healthcare technology can ensure the need for personalized NCDs early detection such as monitoring blood pressure measurements, sugar levels, and others. Smart wearable devices such as smart watches, smart sensors, etc. can continuously record public health care data in real-time and this data can be stored in the cloud. The ML algorithm was used to diagnose patent medical conditions [14].

Artificial intelligence (AI) can improve all actions related to self-care of people with NCDs. AI algorithms can improve control of a person's health status thanks to constantly self-generated knowledge generated from processing millions of data and self-learning tools. Patients can improve self-management of their condition and define their own challenges with physical activity or diet based on their personal characteristics. It also enables health workers and institutions to identify patterns for developing public health measures, and to improve treatment appropriateness [15].

### **Digital Health**

The main function of digital health is as a platform to improve communication between health care providers and patients, and improve continuity of care for people with NCDs. Effective surveillance and delivery of healthcare through digital solutions has a positive effect on the quality of life of patients suffering from chronic conditions. Digital health promotes greater autonomy and self-care, as well as higher rates of adherence to care. Patients with NCDs use digital health to manage their health conditions and get treatment continuity. Healthcare providers use digital health to interact remotely with patients with NCDs, improve electronic health records and get second opinions from specialists. Digital health can reduce unnecessary use of face-to-face services, while still ensuring the provision of health services [15].

Digital healthcare tools are used to improve the prevention and management of NCDs by integrating them into healthcare services. Digital medical devices will increase the digital literacy of



patients, nurses, and health workers. Digital medical devices are designed to be easier to use, and by focusing on the specific limitations (i.e., physical, functional, and cognitive limitations) that patients with NCDs may experience. It is also necessary to design digital medical devices for individuals with limited technological experience (example the elderly), and for people with special needs, such as those with cognitive or sensory impairments [16].

### **Smart healthcare**

Smart healthcare provides services for disease prevention and monitoring, diagnosis and treatment, hospital management, health decision making, and medical research. Information technology uses IoT, mobile Internet, cloud computing, big data, 5G, microelectronics, and artificial intelligence, along with modern biotechnology. Smart healthcare consists of several participants, including doctors and patients, hospitals, and research institutions. Patients can monitor health around the clock, seek medical assistance via virtual assistants, and use remote homes to implement remote services.

Real-time patient health monitoring, immediate feedback of health data, and timely medical behavioral interventions. Doctors use a variety of intelligent clinical decision support systems to assist and improve diagnosis. Doctors can manage medical information through an integrated information platform that includes Laboratory Information Management Systems, Image Archiving and Communication Systems, Electronic Medical Records, and so on. Smart healthcare can effectively reduce the cost and risk of medical procedures, improve the efficiency of utilization of medical resources, promote exchange and cooperation in various regions, encourage the development of telemedicine and self-service medical care, and personalized medical services are ubiquitous [17].

Smart healthcare has proven to be effective at making disease risk predictions by collecting data via existing devices and smart applications, uploading it to the cloud via a network, and analyzing results based on big data-driven algorithms to provide users with real time feedback on predicted results via messaging services. short [18]. Smart healthcare can be used to predict the risk of NCDs, then manage behavior and lifestyle to reduce the risk of NCDs. The results of research using algorithms that integrate blood glucose parameters, eating habits, anthropometry, physical activity, gut microbiota, and

other factors have been successful in predicting changes in glycemic response and reducing diabetes risk through personalized diets [19].

### **mHealth**

In areas and populations where access to smart phones is very low but where access to basic cell phones is high, SMS text messages can be a very useful resource for providing messages related to NCDs management. Some examples such as the WHO initiative Be He@lthy, Be Mobile5 have tackled various NCDs such as smoking cessation, reminders for follow-up appointments for people with diabetes and cancer and for maternal and child care, aimed at self-management, bringing health workers closer to patients. , and even train health workers [15].

mHealth for the prevention and control of NCDs has been implemented in developing countries, including sub-Saharan Africa, India, Indonesia. Health system challenges for NCD care are prophylaxis and prevention, detection and diagnosis, linkage to care, long-term follow-up, providing high-quality care, and coordinating care. mHealth uses SMS-based interventions to send health messages to the public in a relatively short time, including the promotion of healthy behavior, monitoring, management and adherence to NCDs treatment. This will produce a large amount of data that can be used to analyze NCD cases and control NCD [20]. However, the results of a systematic review show that mHealth is not yet effective for the treatment of NCDs in Sub-Saharan Africa, so it is necessary to develop a strategy for further development of mHealth for the treatment of NCDs [21].

### **Telemedicine**

The government of Kazakhstan since 2004 has built a national telemedicine network which has succeeded in realizing its vision according to the strategic plan of the Ministry of Health for 2017–2021, namely “an effective and accessible health system that meets the needs of the population”. The expansion of the telemedicine network is considered essential to further improve the quality of medical care in rural areas by 2050. The telemedicine network ensures the accessibility of specialized medical care to rural populations, providing a wide range of tele-consultation services, including some specifically designed to support the diagnosis and treatment of NCDs. Telemedicine requires technical and non-technical support, including training for health workers, communication,

research, appropriate policies, regulation and reorientation of care pathways [22].

The use of telemedicine in the treatment of diabetes can improve clinical outcomes such as hemoglobin A1c (HbA1c), blood pressure, and the incidence of hypoglycemia. The use of telemedicine for the treatment of type 1 diabetes (T1D), has been shown to be cost-effective, improve appointment adherence, and increase patient satisfaction [23]. Telemedicine for monitoring HbA1c via dry blood spot (DBS) can support the assessment of patient glycemic control [5].

### **Multichannel Interaction in Healthcare Service**

Multichannel interaction in healthcare is an approach based on the interaction between the patient (via their preferred interaction channel) and the healthcare professional, as well as all the IT technical infrastructure needed to create a multichannel interaction environment. The advantage of multichannel interaction services is that it allows interaction between different health care actors (patients, nurses, doctors, administrative staff, pharmacists, technicians) across multiple channels and in different contexts without losing information [24].

Multichannel interaction in health services for NCD sufferers can refer to the multichannel interaction model developed during the Covid-19 pandemic. Multichannel interaction consists of three layers, namely layers for patients, coordination and health care providers. The NCD Patient Layer provides various channels chosen by NCD patients, including through social media, virtual nurse, phone call/SMS, email, Web App, Mobile App. The information available to patients on each channel is independent of the selected channel.

The coordination layer handles all interactions across the various channels that the patient uses to interact with the service provider. This layer is very important because there all the coordination and management of interactions with different channels will be carried out and unify these interactions in a single service on the side of the care provider. The coordination layer coordinates, manages, and integrates all interactions between the different channels that patients use to interact with providers. This layer is responsible for ensuring continuity of service regardless of the situation. The Care Provider layer is a health organization and all health professionals such as nurses, doctors, public health experts, nutritionists and so on who interact with patients. It is in this layer that all the logic and business rules are defined. All patient clinical

records are kept. This layer is of particular importance because it determines everything that will be made available to the patient through the patient's preferred channel [25].

## Conclusion

Society 5.0 enables the use of advanced technologies such as intelligent healthcare, digital health, smart healthcare, mHealth, telemedicine, multichannel interaction for the prevention and control of NCD. This technology can monitor NCD trends and NCD risk factors, reduce the impact of NCD on individuals and society, NCD management interventions (early detection, screening, timely treatment) and provide access to palliative care.

## References

- [1] World Health Organization, *World health statistics 2021-monitoring health for the SDGs, sustainable development goals*. Geneva: World Health Organization, 2021.
- [2] H. Badr, M. A. Maktabi, M. Al-Kandari, and A. M. Sibai, "Review of non-communicable disease research activity in Kuwait: Where is the evidence for the best practice?," *Annals of Global Health*, vol. 85, no. 1. Ubiquity Press, pp. 1–8, 2019.
- [3] D. Purnamasari, "The Emergence of Non-communicable Disease in Indonesia," *Acta Med Indones-Indones J Intern Med* •, vol. 50, no. 4, pp. 273–274, 2018.
- [4] Su. Salvi, "The silent epidemic of COPD in Africa \_ Enhanced Reader," *Lancet Glob Heal*., vol. 3, no. e, pp. 6–7, 2015.
- [5] A. J. Roberts, F. Malik, C. Pihoker, and J. A. Dickerson, "Adapting to telemedicine in the COVID-19 era: Feasibility of dried blood spot testing for hemoglobin A1c," *Diabetes Metab. Syndr. Clin. Res. Rev.*, vol. 15, no. 1, pp. 433–437, Jan. 2021.
- [6] K. Gaur, R. S. Khedar, K. Mangal, A. K. Sharma, R. K. Dhamija, and R. Gupta, "Macrolevel association of COVID-19 with non-communicable disease risk factors in India," *Diabetes Metab. Syndr. Clin. Res. Rev.*, vol. 15, no. 1, pp. 343–350, Jan. 2021.
- [7] S. Stringhini *et al.*, "Socioeconomic status, non-communicable disease risk factors, and walking speed in older adults: Multi-cohort population based study," *BMJ*, vol. 360, pp. 1–10, Mar. 2018.
- [8] A. T. Olawuyi and I. A. Adeoy, "The prevalence and associated factors of non-communicable disease risk factors among civil servants in Ibadan, Nigeria," *PLoS One*, vol. 13, no. 9, pp. 1–19,

- 2018.
- [9] World Health Organization, *Follow-up to the Political Declaration of the High-level Meeting of the General Assembly on the Prevention and Control of Non-communicable Diseases\_2013-2030*. 2013.
- [10] K. Mudie *et al.*, “Non-communicable diseases in sub-saharan Africa: A scoping review of large cohort studies,” *J. Glob. Health*, vol. 9, no. 2, 2019.
- [11] Andreia G. Pereira, T. M. Lima, and F. Charrua-Santos, “Industry 4.0 and Society 5.0: Opportunities and Threats,” *Int. J. Recent Technol. Eng.*, vol. 8, no. 5, pp. 3305–3308, Jan. 2020.
- [12] Hitachi-UTokyo Laboratory (H-UTokyo Lab.), *Society 5.0 A People-centric Super-smart Society*. Tokyo: Springer, 2018.
- [13] S. JOPKIEWICZ and A. JOPKIEWICZ, “Innovations in the dimension of communication in health sector and the perspective of Society 5.0,” *Sci. Pap. Silesian Univ. Technol. Organ. Manag. Ser.*, vol. 2021, no. 150, pp. 47–56, 2021.
- [14] P. K. R. Maddikunta *et al.*, “Industry 5.0: A survey on enabling technologies and potential applications,” *J. Ind. Inf. Integr.*, p. 100257, Aug. 2021.
- [15] Pan American Health Organization, “Digital Health: A Strategy to Maintain Health Care For People Living With Noncommunicable Diseases During Covid-19 Department of Evidence And Intelligence For Action In Health,” 2021.
- [16] A. Monaco *et al.*, “Digital health tools for managing noncommunicable diseases during and after the COVID-19 pandemic: Perspectives of patients and caregivers,” *J. Med. Internet Res.*, vol. 23, no. 1, pp. 1–9, Jan. 2021.
- [17] S. Tian, W. Yang, J. M. Le Grange, P. Wang, W. Huang, and Z. Ye, “Smart healthcare: making medical care more intelligent,” *J. Glob. Health*, vol. 3, no. 3, pp. 62–65, 2019.
- [18] J. Redfern, “Smart health and innovation: Facilitating health-related behaviour change,” in *Proceedings of the Nutrition Society*, 2017, vol. 76, no. 3, pp. 328–332.
- [19] *et al.* D Zeevi, T Korem, N Zmora, “Personalized nutrition by prediction of glycemic responses,” *Cell*, vol. 163, no. 5, pp. 1079–1094, 2015.
- [20] A. Majumdar, S. S. Kar, S. Ganesh Kumar, C. Palanivel, and P. Misra, “mHealth in the prevention and control of non-communicable diseases in India: Current possibilities and the way forward,” *J. Clin. Diagnostic Res.*, vol. 9, no. 2, pp. LE06–LE10, Feb. 2015.

- [21] G. S. Bloomfield, R. Vedanthan, L. Vasudevan, A. Kithei, M. Were, and E. J. Velazquez, "Mobile health for non-communicable diseases in Sub-Saharan Africa: A systematic review of the literature and strategic framework for research," *Global Health*, vol. 10, no. 1, Jun. 2014.
- [22] C. Hamilton, "Telemedicine in Kazakhstan: Bridging the urban-rural divide in delivering prevention, diagnosis, and treatment of noncommunicable diseases," 2018.
- [23] T. Xu, S. Pujara, S. Sutton, and M. Rhee, "Telemedicine in the management of type 1 diabetes," *Prev. Chronic Dis.*, vol. 15, no. 1, pp. 1-9, 2018.
- [24] A. Moreira and M. F. Santos, "Multichannel Interaction for Healthcare Intelligent Decision Support," in *Procedia Computer Science*, 2020, vol. 170, pp. 1053-1058.
- [25] A. Moreira, T. Guimarães, and M. F. Santos, "A conceptual model for multichannel interaction in healthcare services," in *Procedia Computer Science*, 2020, vol. 177, pp. 534-539.

# Fuzzy Logic Optimization Implementation for Optimizing Motor Speed on Barrel Machine

Sumardi Sadi

## Introduction

In processing a product, it is done using a Computer Numerical Control (CNC) lathe to determine the appropriate size, the results of this process sometimes like to cause bars on certain sides of the resulting product, and when touched it will feel rough [1] and do not meet Quality standards. Control (QC), to solve this problem usually use a barrel machine.

The control or control system can be used to regulate the motor speed [2] on a machine that is in an industry. The control system can use various methods, including the fuzzy logic control optimization method. Optimization of fuzzy logic control can use hardware devices such as microprocessors and microcontrollers [3], as well as programmable logic controllers (PLC) [4], or can use a matlab software. This research uses fuzzy logic optimization method based on Tsukamoto, Mamdani and Sugeno methods. This fuzzy logic optimization method can be used to make decisions in a complex process [5]. The problem to be solved is analyzed using these three methods. And the results can be obtained from each of these methods.

One example of a machine that is widely used in industry to produce very good, accurate and precise products is the Barrel CNC machine.

However, due to the current pandemic conditions, production has become erratic, PT. XYZ Tangerang Regency is trying to make a control device on a barrel machine so that it can process products automatically.

For the specifications of the machine you want to make:

1. Can accommodate a minimum load of 50 kg (a little) and a maximum load of 150 kg (a lot).
2. Motor speed of at least 1000 rpm (slow) and a maximum of 2000 rpm (fast).
3. Product sizes are 20 mm (small) and 30 mm (large).
4. Then from the data above I will use the fuzzy logic optimization method (Tsukamoto, Mamdani, Sogeno) to solve the following cases:
5. What is the speed of the motor used in the barrel process with a load of 120 kg and a product size of 25 mm?

a) Fuzzification

It is the process of converting system inputs that have crisp values into linguistic variables (fuzzy) using membership functions stored in the knowledge base.

b) Inference

Is the process of converting fuzzy input into fuzzy output by following the rules (if-then) that have been set on the fuzzy knowledge base.

c) Defuzzification

Is the process of converting the results of the inference stage into output that has a firm value (crisp) using a predetermined membership function.

**Discussion**

From the data I have, the following rules are obtained:

R1: If the load is small and the size is small, then the rotation is slow.

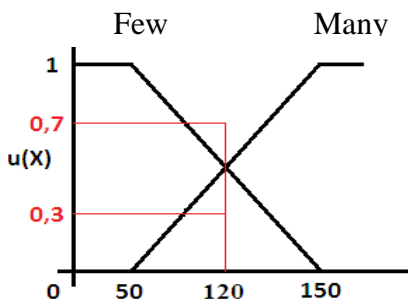
R2: If the load is small and the size is large, then the rotation is slow.

R3: If the load is large and the size is small, then the rotation is fast.

R4: If the load is large and the size is large, then the rotation is fast.

**a) Fuzzification**

Variable 1 : loads amount



**Figure 2 Tsukamoto load amount**

$$\mu_{\text{few}}(120) = \frac{150-120}{150-50} = \frac{30}{100} = 0,3$$
$$\mu_{\text{many}}(120) = \frac{120-50}{150-50} = \frac{70}{100} = 0,7$$



Variable 2 : size product

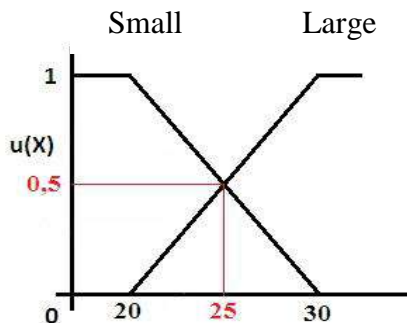


Figure2 Tsukamoto size product fuzzification

$$\mu_{\text{small}}(25) = \frac{30-25}{30-20} = \frac{5}{10} = 0.5$$

$$\mu_{\text{large}}(25) = \frac{25-20}{30-20} = \frac{5}{10} = 0.5$$

Variable 3 : Motor velocity

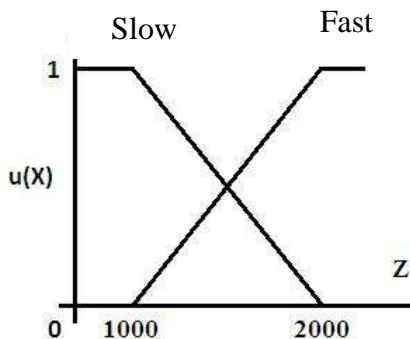


Figure 3 Tsukamoto motor velocity fuzzification

$$\mu_{\text{Fast}}(z) = (2000-z)/(2000-1000)$$

$$\mu_{\text{Slow}}(z) = (z-1000)/(2000-1000)$$

### b) Interferences

R1: If the load is few and the size is small, then the rotation is slow.

$$\begin{aligned} \alpha\text{-predicate } 1 &= \mu_{\text{Few}}(x) \cap \mu_{\text{Small}}(x) \\ &= \min(\mu_{\text{Few}}(120) \cap \mu_{\text{Small}}(25)) \\ &= \min(0.3; 0.5) \\ &= 0.3 \end{aligned}$$

Value Z1

$$\mu(z) = \frac{Z1-1000}{2000-1000}$$
$$0,3 = \frac{Z1-1000}{1000}$$
$$Z1 = 1300$$

**R3:** If the load is many and the size is small, then the rotation is fast.

$$\alpha\text{-predicate 3} = \mu_{\text{Many}}(x) \cap \mu_{\text{Small}}(x)$$
$$= \min(\mu_{\text{Many}}(120) \cap \mu_{\text{Small}}(25))$$
$$= \min(0.7; 0.5)$$
$$= 0.5$$

Value Z3

$$\mu(z) = \frac{2000-Z}{2000-1000}$$
$$0,5 = \frac{2000-Z}{1000}$$
$$Z3 = 1500$$

**R4:** If the load is many and the size is large, then the rotation is fast.

$$\alpha\text{-predikat4} = \mu_{\text{Many}}(x) \cap \mu_{\text{Large}}(x)$$
$$= \min(\mu_{\text{Many}}(120) \cap \mu_{\text{Large}}(25))$$
$$= \min(0.7; 0.5)$$
$$= 0.5$$

Value Z4

$$\mu(z) = \frac{2000-Z}{2000-1000}$$
$$0,5 = \frac{2000-Z}{1000}$$
$$Z4 = 1500$$

### c) Defuzzification

$$Z^{\circ} = \frac{\sum_i^n \text{apredicate } i * z_i}{\sum_i^n \text{apredicate } i}$$

$$Z^{\circ} = \frac{(0,3*1300)+(0,3*1300)+(0,5*1500)+(0,5*1500)}{(0,3+0,3+0,5+0,5)}$$

$$Z^{\circ} = \frac{2280}{1,6} = 1425$$

In conclusion, motor velocity used in barrel process with 120 kg load amount and 25 mm size product is 1425 rpm.

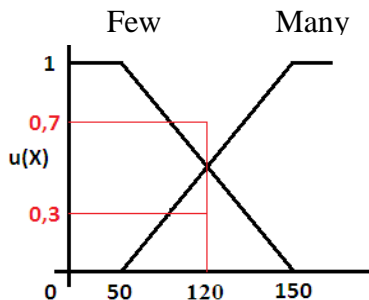
### Mamdani Method

From the data I have, the following rules are obtained:

- R1: If the load is few and the size is small, then the rotation is slow.
- R2: If the load is few and the size is large, then the rotation is slow.
- R3: If the load is many and the size is small, then the rotation is fast.
- R4: If the load is many and the size is large, then the rotation is fast.

#### a) Fuzzification

Variable 1 : Load amount

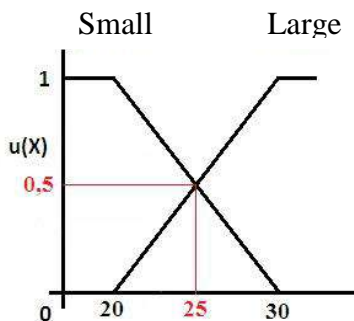


**Figure 4 Mamdani load amount fuzzification**

$$\mu_{\text{Few}}(120) = \frac{150-120}{150-50} = \frac{30}{100} = 0,3$$

$$\mu_{\text{Many}}(120) = \frac{120-50}{150-50} = \frac{70}{100} = 0,7$$

Variable 2 : Size product

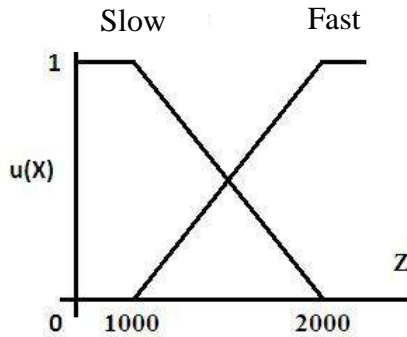


**Figure 5 Mamdani size product fuzzification**

$$\mu_{\text{Small}}(25) = \frac{30-25}{30-20} = \frac{5}{10} = 0.5$$

$$\mu_{\text{Large}}(25) = \frac{25-20}{30-20} = \frac{5}{10} = 0.5$$

Variable 3 : Motor Velocity



**Figure 6 Mamdani motor velocity fuzzification**

$$\mu_{\text{Fast}}(z) = (2000-z)/(2000-1000)$$

$$\mu_{\text{Slow}}(z) = (z-1000)/(2000-1000)$$

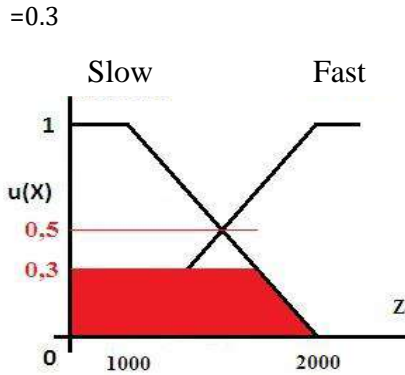
**b) Inferences**

R1: If the load is few and the size is small, then the rotation is slow.

$$\alpha\text{-predicate1} = \mu_{\text{Few}}(x) \cap \mu_{\text{Small}}(x)$$

$$= \min(\mu_{\text{Few}}(120) \cap \mu_{\text{Small}}(25))$$

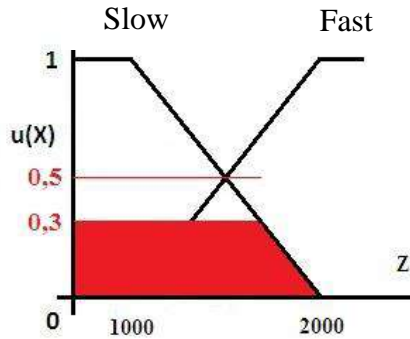
$$= \min(0.3; 0.5)$$



**Figure 7 Mamdani first slow-fast interferences**

R2: If the load is few and the size is large, then the rotation is slow.

$$\begin{aligned}
 \alpha\text{-predicate2} &= \mu_{\text{Few}}(x) \cap \mu_{\text{Large}}(x) \\
 &= \min(\mu_{\text{Few}}(120) \cap \mu_{\text{Large}}(25)) \\
 &= \min(0.3; 0.5) \\
 &= 0.3
 \end{aligned}$$



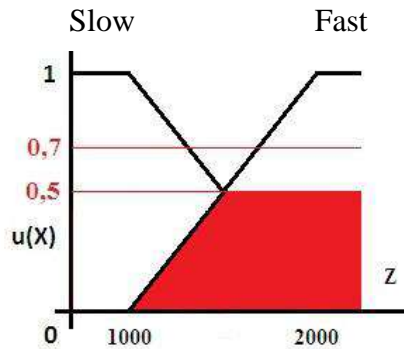
**Figure 8 Mamdani second slow-fast interferences**

R3: If the load is many and the size is small, then the rotation is fast.

$$\begin{aligned}
 \alpha\text{-predicate3} &= \mu_{\text{Many}}(x) \cap \mu_{\text{Small}}(x) \\
 &= \min(\mu_{\text{Many}}(120) \cap \mu_{\text{Small}}(25))
 \end{aligned}$$

$$= \min(0.7; 0.5)$$

$$= 0.5$$



**Figure 9 Mamdani third slow-fast interferences**

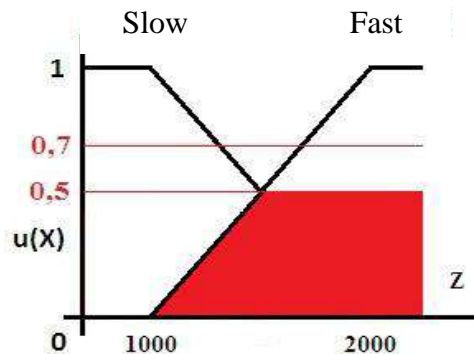
R4: If the load is many and the size is large, then the rotation is fast.

$$\propto\text{-predicate4} = \mu_{\text{Many}}(x) \cap \mu_{\text{Large}}(x)$$

$$= \min(\mu_{\text{Many}}(120) \cap \mu_{\text{Large}}(25))$$

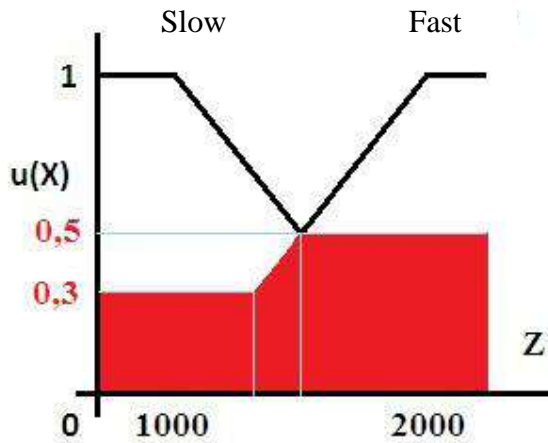
$$= \min(0.7; 0.5)$$

$$= 0.5$$

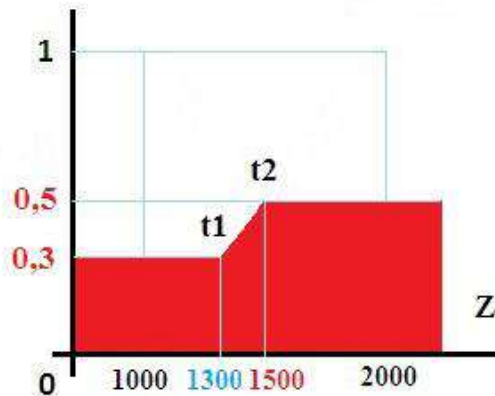


**Figure 10 Mamdani fourth slow-fast interferences**

Then, combine highest part in each chart of linguistic variable.



**Figure 11 Mamdani total slow-fast interferences**  
To calculate Z value, firstly determine t1 and t2 cut off point.



**Figure 12 Mamdani Z Value**

$$\begin{aligned}
 \text{t1 value} &= \frac{t1-1000}{2000-1000} = 0,3 \\
 &= \frac{t1-1000}{1000} = 0,3 \\
 &= t1-1000 = 300 \\
 \text{t1} &= 1300 \\
 \text{t2 value} &= \frac{t2-1000}{2000-1000} = 0,5 \\
 &= \frac{t2-1000}{1000} = 0,5 \\
 &= t2-1000 = 500
 \end{aligned}$$

$$t_2 = 1500$$

### c) Defuzzification

T1 and t2 cut off point divides the curve into 3 areas; D1,D2, D3 with each width is A1, A2, A3 and each moment M1, M2, M3.

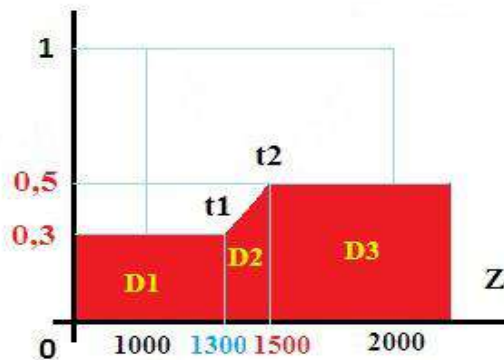


Figure 13 Mamdani defuzzification

Mamdani Defuzzification formula :

$$Z^* = \frac{\int \mu(z)z dz \text{ (Moment/M)}}{\int \mu(z)dz \text{ (Width/A)}}$$

❖ First, calculate the Moment

$$M1 = \int_0^{1300} 0,3z dz = [0,3 * \frac{1}{2} z^2]_0^{1300} = 253500$$

$$M2 = \int_{1300}^{1500} \frac{z-1000}{2000-1000} z dz = \int_{1300}^{1500} (0,001z^2 - 1z) dz = 112666,7$$

$$M3 = \int_{1500}^{2000} 0,5z dz = [0,3 * \frac{1}{2} z^2]_{1500}^{2000} = 437500$$

❖ Calculate A width

$$A1 = 1300 * 0,3 = 390$$

$$A2 = \frac{(0,3+0,5) * (1500-1300)}{2} = 80$$



$$A3 = (2000 - 1500) * 0,5 = 250$$

❖ Calculate Z with centroid method

$$\begin{aligned} Z^* &= \frac{\int \mu(z)z \, dz \text{ (Momen/M)}}{\int \mu(z) \, dz \text{ (Luas/ A)}} \\ &= \frac{253500 + 112666,7 + 437500}{390 + 80 + 250} \\ &= \frac{803666,7}{720} = 1116,20375 = 1116 \end{aligned}$$

In conclusion, motor velocity used in barrel process with 120 kg load amount and 25 mm size product is 1116 rpm.

### Sugeno Method

Sugeno method is nearly the same with Mamdani's reasoning, except the system output which is not a fuzzy set, but a constant or a linear equation. The Sugeno method consists of 2 types, namely the zero order Sugeno fuzzy model and the one order Sugeno fuzzy model.

From the data I have, the following rules are obtained:

- R1: If the load is few and the size is small then the rotation = 1000.
- R2: If the load is few and the size is large then the rotation = 10\*load
- R3: If the load is many and the size is small then the rotation = 12\*(load - size)
- R4: If the load is many and the size is large then the rotation = 12\*(load + size)

#### a) Fuzzification

Variable 1 : Load amount

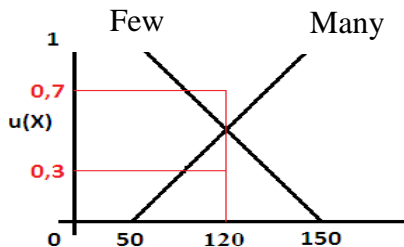
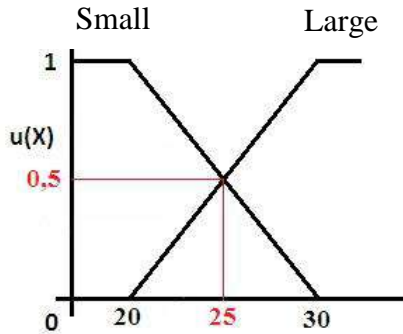


Figure 14 Sugeno load amount fuzzification

$$\mu_{\text{Few}}(120) = \frac{150-120}{150-50} = \frac{30}{100} = 0,3$$

$$\mu_{\text{Many}}(120) = \frac{120-50}{150-50} = \frac{70}{100} = 0,7$$

Variable 2 : Size product

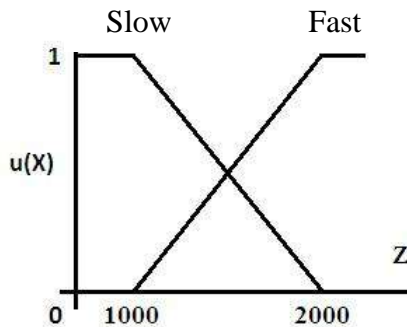


**Figure 15 Sugeno size product fuzzification**

$$\mu_{\text{Small}}(25) = \frac{30-25}{30-20} = \frac{5}{10} = 0.5$$

$$\mu_{\text{Large}}(25) = \frac{25-20}{30-20} = \frac{5}{10} = 0.5$$

Variable 3 : Motor velocity



**Figure 16 Sugeno motor velocity fuzzification**

$$\mu_{\text{Fast}}(z) = (2000-z)/(2000-1000)$$

$$\mu_{\text{Slow}}(z) = (z-1000)/(2000-1000)$$

### b) Inferences

R1: If the load is few and the size is small then the rotation = 1000.

$$\begin{aligned}
\alpha\text{-predicate1} &= \mu_{\text{Few}}(x) \cap \mu_{\text{Small}}(x) \\
&= \min(\mu_{\text{Few}}(120) \cap \mu_{\text{Small}}(25)) \\
&= \min(0.3; 0.5) \\
&= 0,3 \\
\text{Value Z1} &= 1000
\end{aligned}$$

R2: If the load is few and the size is large then the rotation =  
10\*load

$$\begin{aligned}
\alpha\text{-predicate2} &= \mu_{\text{Few}}(x) \cap \mu_{\text{Large}}(x) \\
&= \min(\mu_{\text{Few}}(120) \cap \mu_{\text{Large}}(25)) \\
&= \min(0.3; 0.5) \\
&= 0,3 \\
\text{Value Z2} &= 10*120 \\
&= 1200
\end{aligned}$$

R3: If the load is many and the size is small then the rotation =  
12\*(load - size)

$$\begin{aligned}
\alpha\text{-predicate3} &= \mu_{\text{Many}}(x) \cap \mu_{\text{Small}}(x) \\
&= \min(\mu_{\text{Many}}(120) \cap \mu_{\text{Small}}(25)) \\
&= \min(0.7; 0.5) \\
&= 0,5 \\
\text{Value Z3} &= 12*(120-25) \\
&= 1140
\end{aligned}$$

R4: If the load is many and the size is large then the rotation =  
12\*(load + size)

$$\begin{aligned}
\alpha\text{-predicate4} &= \mu_{\text{Many}}(x) \cap \mu_{\text{Large}}(x) \\
&= \min(\mu_{\text{Many}}(120) \cap \mu_{\text{Large}}(25)) \\
&= \min(0.7; 0.5) \\
&= 0,5 \\
\text{Value Z4} &= 12*(120+25) \\
&= 1740
\end{aligned}$$

### c) Defuzzification

$$Z^{\circ} = \frac{\sum_i^n \text{apredicate } i * z_i}{\sum_i^n \text{apredicate } i}$$

$$Z^{\circ} = \frac{(0,3*1000)+(0,3*1200)+(0,5*1140)+(0,5*1740)}{(0,3+0,3+0,5+0,5)}$$

$$Z^{\circ} = \frac{2100}{1,6} = 1312,5 = 1312$$

Motor velocity that used in barrel process with 1200 kg load amount and 25 mm size product is 1312 rpm.

## Conclusion

In the case that I solved using the tsukamoto, mamdani, and sogeno methods, it turned out to different results. For the calculation of defuzzification, Tsukamoto and Sugeno have the same method. To calculate inference these three methods have their own way. In terms of understanding, I think the Tsukamoto and Sugeno methods are easier than the Mamdani method and the solution is more concise.

## References

- [1] A. Zubaidi, M. Fcd, P. Mesin, and I. Syafa, "Terhadap Kekasaran Permukaan," *Momentum*, vol. 8, no. 1, pp. 40–47, 2012.
- [2] M. Sukmawidjaja and B. Nursulistyo, "Pengaturan Kecepatan Motor DC," *J. Ilm. Tek. Elektro*, vol. 12, p. 1, 2014, [Online]. Available: <https://trijurnal.lemlit.trisakti.ac.id/index.php/jetri/article/view/1453>.
- [3] D. F. Al Riza, R. Damayanti, and Y. Hendrawan, "RANCANG BANGUN FERMENTOR YOGURT DENGAN SISTEM KONTROL LOGIKA FUZZY MENGGUNAKAN MIKROKONTROLER ATMEGA32 (Yogurt Fermenter Design with Fuzzy Logic Control System Using Microcontroller ATmega32)," *J. Agritech*, vol. 34, no. 04, p. 456, 2015, doi: 10.22146/agritech.9441.
- [4] Y. Birbir and H. S. Nogay, "Design and Implementation of PLC - Based Monitoring Control System for Three-Phase Induction Motors Fed by PWM Inverter," *Int. J. Syst. Appl. Eng. Dev.*, vol. 2, no. 3, pp. 128–135, 2008.
- [5] sekolah tinggi nuklir-B. Supriyono, "Aplikasi Logika Fuzzy Pada Optimasi Daya Lisrik Sebagai Sistem Pengambilan Keputusan," *Semin. Nas. Ii Sdm Teknol. Nukl. Yogyakarta*, pp. 285–292, 2006.

# Agriculture Based on Biochemistry and Information Systems in Era 5.0

Suryani<sup>111</sup>

## Introduction

Era 5.0 will make things easy by integrating virtual space and physical space. Japan has initiated this by applying digital technology centered on human life.[1]. Society 5.0 is a super-intelligent society where big data, the Internet of Things (IoT), artificial intelligence (A.I.), and robots blend into every industry and social segment. So also with the field of Chemistry collaborated with Agroindustry and I.T. It would be better to produce with collaboration because each will be an expert in his field and will be perfect when collaborating. Chemists will maximize chemistry research, which can also collaborate with pharmacists and will be collected in the form of Big data by alhi I.T., this information is used to make intelligent machines that humans want. It can be controlled from afar by using the internet as per human wishes.

All obstacles are used as challenges, such as the Covid-19 pandemic originating from Wuhan.[2]–[5], Humans need good drugs, chemically synthetic drugs.[6], [7] Or herbal or traditional [4], [8], to fight it. Herbal medicines needed are natural ingredients that have antimicrobial capabilities.[9], [10] both antibacterial and antifungal and especially antiviral. In addition, raw materials with immunomodulator capabilities strengthen our body's endurance.

Among the natural ingredients that have antibacterial, natural antibiotics, antifungal and antiviral abilities, and immunomodulators' ability are VCO. The search for a suitable vaccine is also always done, although until now there is no vaccine that matches covid-19.[11], Because it's always mutated. This obstacle will finally be able to be facilitated and in accordance with what humans want, namely by consuming VCO and other herbal remedies. It therefore needs an intelligence to create a VCO, using remotely controlled human-controlled working robots using the help of the internet.

---

<sup>111</sup> Muhammadiyah University of West Sumatera

The challenge for the future is not only about covid-19, But the agricultural problem that will arise is about the climate. A climate anomaly has started from now, thus affecting the growing season for agriculture that depends on the season. For the time of 5.0, agriculture no longer depended on the seasons, but humans governed the farm. How?. Agriculture is no longer in the ground but can be in tall buildings or greenhouses where CH<sub>4</sub> or N<sub>2</sub>O emissions are regulated. Its climate or things required by cultivation such as temperature, humidity, irrigation or water availability[12], pH, nutrients, and such are controlled by humans from afar using the internet (IoT) and buttons from Hape only.

Agriculture cultivates staples, or primary metabolites, and has cultivated secondary metabolites. Where secondary metabolite substances to be produced by plants are regulated by humans over the internet with a remote handphone. That nursery is no longer conventional but has been practiced with tissue culture.[13].

## **Discussion**

One example of human needs for the present, until the time of 5.0, is the herbal supplement Virgin Coconut oil (VCO). Because this virus is always mutated, we will always be haunted by this virus. So we have to defend ourselves. VCO is pure coconut oil made by fermenting coconut milk without heating or adding inoculum or other bacteria.[10], [14]–[18]. But it requires certain chemical or physical conditions such as humidity, temperature, enzyme concentration, or substrate concentration for fermentation to be successful. Virgin Coconut Oil is very much a health benefit, especially to help cure covid-19 and maintain the body's immunity so that the covid-19 virus cannot attack it.[19], [20]. The use of VCO to maintain immunity and help the treatment of covid should be more popularized and socialized because this VCO is based on plants or herbal plants that not all countries have this natural produce. Indonesia is the world's No. 1 coconut producer, Malaysia, Thailand, India, and Bangladesh. In comparison, the U.S. has very few, namely in the Islands of Hawaii.

## Virgin Coconut Oil, which is used to meet human needs



**Figure 1. Virgin Coconut Oil**

To make Virgin Coconut Oil, this can be through robots or intelligent machines. To make it needs some information collected in Big data, and will be translated into I.T. language. The tool is by mechanical engineers in collaboration with I.T. experts. The conditions manufactured are set from afar and controlled by humans according to the wishes of that human being. The required information is as follows,

1. Raw materials
  - a. Coconut age one year
  - b. Cook
  - c. There is no puff/cork in coconuts
2. Coconut milk
  - a. Comparison of grated coconut with water 1:2
  - b. Viskositas
  - c. Temperature
  - d. Light
  - e. Moisture
  - e. pH
3. VCO
  - a. Lauric fatty acids
  - b. Palmitic Fatty Acids
  - c. Myristate fatty acids
  - d. Stearic Fatty Acids
  - e. Other fatty acids
  - f. Antimicrobial ability
  - g. Antibiotic ability
  - h. Antivirus capabilities
  - i. Immunomodulator capabilities
  - j. Components of phenol compounds
  - k. Sterol compounds
  - l. Steroids

- m. Alkaloids
- n. Tocopherol

It can be explained at No. 1. It is the selection of raw materials done by humans because it cannot be helped. Humans must do it. Then the coconut fruit is peeled using a machine, divided using a device, then taken coconut meat using a machine, and mashed still using a machine. Following VCO produce is no. 2. Using a machine, the manufacture of coconut milk with a water arrangement compared to fine coconut is 2:1 can be by using a machine. Then the fermentation process also uses a machine equipped with viscosity, temperature, light, humidity, and pH measuring instruments. Finally, no. 3, VCO produced from fermentation can be harvested with the machine modified using the principle of separation. It can be done using a machine that serves as a centrifuge separating the liquid from the twisted solids. And immediately in the analysis of the VCO content of the harvest by installing G.C. chromatography tools. All of them are digital and used for human purposes. Humans can control this process from an infinite distance by using the internet network. Control by humans is when humidity is less qualified, then the alarm will sound, and humans can remotely process the increase in humidity so that the process runs.

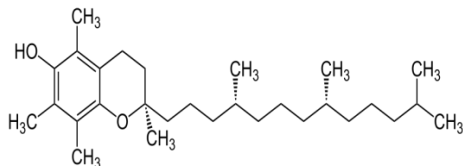
#### **Antimicrobial analysis of Virgin Coconut Oil.**

The thing that supports VCO can help human difficulties in era 5.0 is because there has been some research on its antimicrobial capabilities.[20], [21], Using test bacteria *Lactobacillus plantarum*, *Lactobacillus thermobacterium*, *Corineabacterium bovis*, *Corineabacterium xerosis*, and *Microoccus luteus*[21]-[23]. Continued by using pathogenic bacteria isolated from the push of patients with otitis media suppurative khronis (OMSK).[24], yaitu *Staphilococcus aureus*, *Pseudomonas sp*, *Escherichia coli*, and *Klebsiella sp*. In addition to antibacterial has also been done antifungal with mushroom tests are *Candida*, dan *Rizhopus*.

#### **Bioactive components of coconut plants present in VCO.**

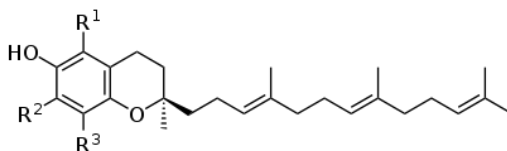
Coconut plants contain secondary metabolites as bioactive components that can inhibit the growth of covid -19 [16], [20] like,





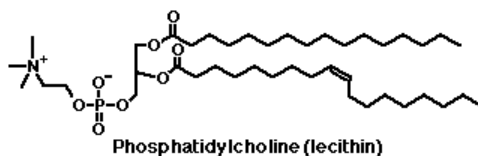
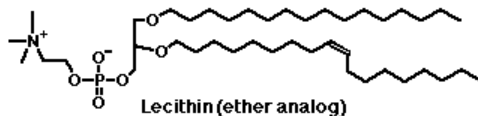
**Figure 2. Structure of Tocoferol**

In figure 2 is a bioactive Tocoferol that serves as an antioxidant substance that can inhibit the growth of the covid-19 virus



**Figure 3. Structure of Tocotrienol**

Figure 3 is the bioactive structure of VCO which is a tocotrienol derivative of phenol compounds that can inhibit the development of covid-19.



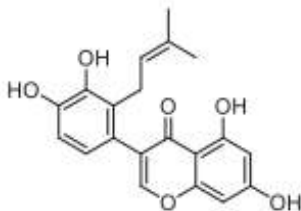
**Figure 4. Phospholipid Structure**

Virgin Coconut Oil conceives various types of fatty acids as a bioactive that can inhibit the life of the covid-19 virus, either as an antimicrobial, antiviral, anti-cancer, or as an immunomodulator. Three types of VCO are distinguished from water to extract coconut milk is analyzed its fatty acid content which results are as follows. In

VCO (A), which water to remove grated coconut water is used, the fatty acid Laurat 54. 06% (at most), palmitic fatty acids not found, stearic fatty acids 12. 03%. For VCO(B), lauric fatty acids were 53.90%, palmitic fatty acids were not found, and stearate fatty acids were 12.01%. And for VCO(C), its lauric fatty acids were 53.70%, its palmitic fatty acids were also not found, and its stearic fatty acids were 11.9%.

**Cultivation of agricultural, medicinal plants / secondary metabolites.**

The problem of tackling the covid-19 virus in era 5.0 can be solved using drugs from natural materials that produce secondary metabolites. So that the farm moves on the cultivation of medicinal plants. The use of medicinal plants is very significant, because based on the utilization of bioactive compounds [26], such as the description of the following plant phytochemicals,



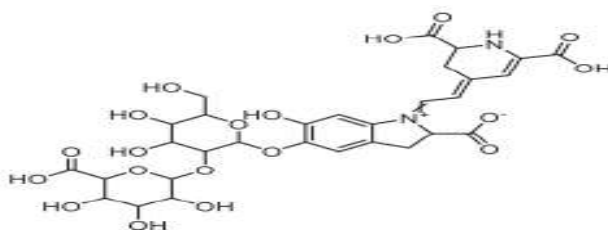
**Figure 5. 5,7,30,40-Tetrahydroxy-2'-(3,3-dimethylallyl) isoflavon**

Figure 5. Showing the structure of phytochemicals that become secondary metabolites is 5,7,30,40-Tetrahydroxy- 2'-(3,3-dimethylallyl) isoflavones derived from the psororhannus arborescent plant. This plant can inhibit the growth of the covid-19 virus. In Indonesia this the plant is called the renek tree.



**Figure 6. Renek Tree Palnts that can inhibit the growth of the covid-19 virus**

Red spinach vegetables have an excellent bioactive component to inhibit the growth of the covid-19 virus

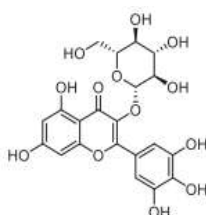


**Figure 7. Amaranthine**

Figure 7. It can be explained that the phytochemical structure of the red spinach vegetable plant is Amaranthin. This red spinach vegetable can inhibit the growth of the covid-19 virus.



**Figure 8. Red spinach vegetables**



**Figure 9. Myricetin 3-O Camellia beta-D-Sinensis glucopyranoside**

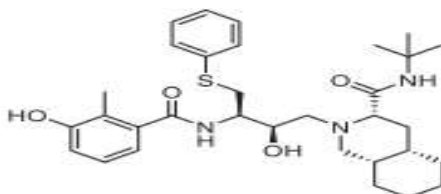
Figure 9 explains the phytochemicals structure of the bioactive Myricetin 3-O-Camellia beta-D-Sinensis glucopyranoside. This bioactive substance is found in the tea plant Camellia Sinensis. So that for the time to come, the indeed need to be popular when

cultivating and its use. Because it contains bioactive substances that can inhibit the growth of covid-19

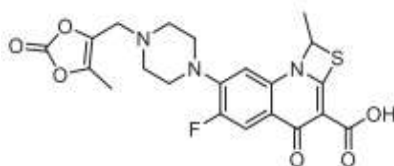


**Figure 10. The plant that contains phytochemistry antiviral covid-19**

Artificial drugs used to kill the covid-19 virus are usually those that have the following active components,



**Figure 11. Nelfinavir**



**Figure 12. Prulifloxacin**

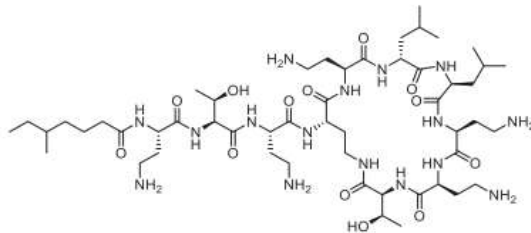


Figure 13. Colistin

It is best to use herbal medicines. We are no longer using synthetic drugs.

### **Breeding with Genetic Engineering methods**

There are also nurseries using genetic engineering methods, among others, by using tissue culture or engineering seedlings according to human wishes. Such as engineering rice seedlings that respond to drought[13]. For the time of 5.0, this will be even more popular, such as cultivating rice seeds that produce more fruit with tissue culture.[25]. Breeding plants such as in Japan [26], namely rice breeding based on its genomics in the future in Indonesia, will also occur. Rice seeds resistant to Methane and N2O emissions [12] are also made through genetic engineering. Rice growth can be monitored with synthetic aperture radar (SAR) time series.[27], It is connected to the Internet (IoT). Likewise, the problem before harvest is studied using molecular mechanisms.[28] so that the resulting seedlings do not experience loss before harvest. To get rice seeds whose rice color is putting clean and no longer requires bleach, the manufacture of seedlings is also done by genetic engineering by marking the properties of the white carrier.[29].

### **Conclusion**

Agriculture in the future, era 5.0 is agriculture that collaborates between agrotechnology, chemistry, especially biochemistry, and the Internet. Or it's also said that agriculture is integrated. All of that serves human needs and is controlled by humans from far separate places connected to cyberspace. Human health control also goes back to natural or herbal ingredients, which breed through genetic engineering techniques.

## References

- [1] M. A. Berawi, "Managing Nature 5.0 in industrial revolution 4.0 and society 5.0 era," *Int. J. Technol.*, vol. 10, no. 2, pp. 222–225, 2019, doi: 10.14716/ijtech.v10i2.3084.
- [2] N. Chen *et al.*, "Epidemiological and clinical characteristics of 99 cases of 2019 novel coronavirus pneumonia in Wuhan, China: a descriptive study," *Lancet*, vol. 395, no. 10223, pp. 507–513, 2020, doi: 10.1016/S0140-6736(20)30211-7.
- [3] C. Wu *et al.*, "Risk Factors Associated with Acute Respiratory Distress Syndrome and Death in Patients with Coronavirus Disease 2019 Pneumonia in Wuhan, China," *JAMA Intern. Med.*, vol. 180, no. 7, pp. 934–943, 2020, doi: 10.1001/jamainternmed.2020.0994.
- [4] E. Luo *et al.*, "Treatment efficacy analysis of traditional Chinese medicine for novel coronavirus pneumonia (COVID-19): An empirical study from Wuhan, Hubei Province, China," *Chinese Med. (United Kingdom)*, vol. 15, no. 1, pp. 1–13, 2020, doi: 10.1186/s13020-020-00317-x.
- [5] N. Zhu *et al.*, "A Novel Coronavirus from Patients with Pneumonia in China, 2019," *N. Engl. J. Med.*, vol. 382, no. 8, pp. 727–733, 2020, doi: 10.1056/nejmoa2001017.
- [6] S. G. Viveiros Rosa and W. C. Santos, "Clinical trials on drug repositioning for COVID-19 treatment," *Rev. Panam. Salud Publica/Pan Am. J. Public Heal.*, vol. 44, pp. 1–7, 2020, doi: 10.26633/RPSP.2020.40.
- [7] C. Shen *et al.*, "Treatment of 5 Critically Ill Patients with COVID-19 with Convalescent Plasma," *JAMA - J. Am. Med. Assoc.*, vol. 323, no. 16, pp. 1582–1589, 2020, doi: 10.1001/jama.2020.4783.
- [8] I. Aanouz, A. Belhassan, K. El-Khatibi, T. Lakhlifi, M. El-Ildrissi, and M. Bouachrine, "Moroccan Medicinal plants as inhibitors against SARS-CoV-2 main protease: Computational investigations," *J. Biomol. Struct. Dyn.*, vol. 39, no. 8, pp. 2971–2979, 2021, doi: 10.1080/07391102.2020.1758790.
- [9] Suryani, A. Dharma, Y. Manjang, S. Arief, E. Munaf, and N. Nasir, "Antimicrobial and antifungal activity of Lactic Acid Bacteria isolated from coconut milk fermentation," *Res. J. Pharm. Biol. Chem. Sci.*, vol. 5, no. 6, pp. 1587–1595, 2014.
- [10] A. Suryani, Dharma A, Manjang Y, Arief S, "Isolation and Characterization of Bacteriocins Bacteria *Lactobacillus Plantarum* Strain NM178-5 from Fermentation Process which Contained on Coconut Milk," *Transylvanian Rev.*, vol. XXIV, no. 6,

- pp. 614–628, 2016.
- [11] R. Wu *et al.*, “An Update on Current Therapeutic Drugs Treating COVID-19,” *Curr. Pharmacol. Reports*, vol. 6, no. 3, pp. 56–70, 2020, doi: 10.1007/s40495-020-00216-7.
- [12] A. Z. Oo *et al.*, “Methane and nitrous oxide emissions from conventional and modified rice cultivation systems in South India,” *Agric. Ecosyst. Environ.*, vol. 252, no. May 2017, pp. 148–158, 2018, doi: 10.1016/j.agee.2017.10.014.
- [13] Y. Oladosu *et al.*, “Drought Resistance in Rice from Conventional to Molecular Breeding: A Review,” *Int. J. Mol. Sci.*, vol. 20, no. 14, 2019, doi: 10.3390/ijms20143519.
- [14] Y. P. Suryani Suryani, Fauzan, Marganof, “Karakterisasi Bakteriosin pada Bakteri Asam Laktat *Lactobacillus Paracasei* dari Virgin Coconut Oil,” *J. Katalisator*, vol. 5, no. 1, pp. 1–16, 2020.
- [15] G. K. A. G, G. Raj, A. S. Bhatnagar, P. K. P. K, and P. Chandrashekar, “Coconut Oil : Chemistry , Production and Its Applications - A Review,” *Indian Coconut J.*, vol. 53, no. 3, pp. 15–27, 2010.
- [16] S. Suryani *et al.*, “A comparative study of virgin coconut oil, coconut oil and palm oil in terms of their active ingredients,” *Processes*, vol. 8, no. 4, pp. 1–11, 2020, doi: 10.3390/PR8040402.
- [17] F. A. Sinaga, U. Harahap, J. Silalahi, and H. Sipahutar, “Antioxidant effect of virgin coconut oil on urea and creatinine levels on maximum physical activity,” *Open Access Macedonian Journal of Medical Sciences*, vol. 7, no. 22. pp. 3781–3785, 2019, doi: 10.3889/oamjms.2019.503.
- [18] D. C. Widianingrum, C. T. Noviandi, and S. I. O. Salasia, “Antibacterial and immunomodulator activities of virgin coconut oil (VCO) against *Staphylococcus aureus*,” *Heliyon*, vol. 5, no. 10, p. e02612, 2019, doi: 10.1016/j.heliyon.2019.e02612.
- [19] Suryani, “VCO (Virgin Coconut Oil) Dapat Digunakan Sebagai Obat Membunuh Coccid,” *Forum sumbar*, vol. XXIV, pp. 2016–2018, 2020.
- [20] Suryani Suryani, *Virgin Coconut Oil: Bakteri Asam Laktat dan Bakteriosin.*, 1st ed. Unitomo Press, 2020.
- [21] S. Suryani, Zulmardi, A. Dharma, and N. Nasir, “Isolation and identification of pathogenic bacteria secretion of chronic suppurative otitis media patients,” *Rasayan J. Chem.*, vol. 11, no. 3, pp. 1139–1143, 2018, doi: 10.31788/RJC.2018.1131966.
- [22] A. Suryani, Dharma A, Manjang Y, Arief S, “Isolation and Characterization of Bacteriocins Bacteria *Lactobacillus*

- palnatarum NM178-5 from Fermentation Process which Contained on Coconut Milk," *Transylvanian Rev.*, vol. XXIV, no. 6, pp. 614–628, 2016.
- [23] S. Suryani, D. Nofiandi, H. Mukhtar, M. Siska, A. Dharma, and N. Nasir, "IDENTIFIKASI MOLEKULAR BAKTERI ASAM LAKTAT *Lactobacillus paracasei* YANG ADA PADA LAPISAN MINYAK VCO," *J. Katalisator*, vol. 2, no. 2, p. 79, 2017, doi: 10.22216/jk.v2i2.2517.
- [24] S. Suryani, "ISOLASI BAKTERI PATTOGEN PADA PASIEN PENDERITA INFEKSI TELINGA Chronic suppurative otitis media (OMSK)," *J. Katalisator*, vol. 1, no. 2, 2016, doi: 10.22216/jk.v1i2.1005.
- [25] Y. Huang *et al.*, "Variation in the regulatory region of FZP causes increases in secondary inflorescence branching and grain yield in rice domestication," *Plant J.*, vol. 96, no. 4, pp. 716–733, 2018, doi: 10.1111/tbj.14062.
- [26] A. Kobayashi, K. Hori, T. Yamamoto, and M. Yano, "Koshihikari: a premium short-grain rice cultivar – its expansion and breeding in Japan," *Rice*, vol. 11, no. 1, 2018, doi: 10.1186/s12284-018-0207-4.
- [27] K. Clauss, M. Ottinger, P. Leinenkugel, and C. Kuenzer, "Estimating rice production in the Mekong Delta, Vietnam, utilizing time series of Sentinel-1 SAR data," *Int. J. Appl. Earth Obs. Geoinf.*, vol. 73, no. March, pp. 574–585, 2018, doi: 10.1016/j.jag.2018.07.022.
- [28] F. Xu, J. Tang, S. Gao, X. Cheng, L. Du, and C. Chu, *Control of rice pre-harvest sprouting by glutaredoxin-mediated abscisic acid signaling*, vol. 100, no. 5. 2019.
- [29] D. K. Lim, C. Mo, D. K. Lee, N. P. Long, J. Lim, and S. W. Kwon, "Non-destructive profiling of volatile organic compounds using HS-SPME/GC-MS and its application for the geographical discrimination of white rice," *J. Food Drug Anal.*, vol. 26, no. 1, pp. 260–267, 2018, doi: 10.1016/j.jfda.2017.04.005.



# **Problem Based Learning Model Integrated With Islamic Values**

Sutrisni Andayani<sup>112</sup>

## **Introduction**

Society 5.0 is a human-centered and technology-based concept of society. This concept was born as a development of the Industrial Revolution 4.0 Industrial Revolution 4.0 is considered to have the potential to degrade human roles. Society 5.0 aims to integrate virtual space and physical space with the help of technology [1]. This era is an integration of science and technology with economic progress and the resolution of social problems [2]. Technological advances cover various fields including transformation technology, information, communication, medical, construction and education. These technological advances also occur during the COVID-19 pandemic, where the students study a lot from home. Teachers and students learn with limited face to face and online system using communication and information technology

With regard to technology in education, efforts to facilitate and improve learning performance are the definition of educational technology. As AECT 2008 states that educational technology is the study and ethical practice to facilitate and improve learning performance. The study and ethical practice can be through the creation, use, management of processes, and technological resources [2]. In the learning process we expect a learning process to occur in students. The learning process is carried out to obtain behavioral changes in the cognitive, affective and psychomotor domains. Learning is a process in which an organism changes its behavior. Behavioral changes occur based on the results of practice or experience. Change processes using certain methods and the results of the changes tend to last a long time [3]. In order for a good learning process to occur, teachers try to apply learning method/model

The learning model is a pattern for designing learning materials in order to form a curriculum (long-term plan). The function of this model to guide learning in the classroom [4]. [5] Trianto calls it a conceptual framework in organizing learning experiences through systematic procedures to achieve the learning objectives. In using the learning model the teacher can help students learn and achieve

---

<sup>112</sup> University of Muhammadiyah Metro

learning goals [6]. The learning model is a systematic pattern or plan as a guide for teachers in learning activities. The systematic pattern is done by organizing the learning process and experience. Organizing learning aims to assist students in learning and to achieve their learning goals. The application of the learning model is part of the effort to achieve learning objectives and improve learning performance. The learning model can be done using learning resources and learning technology.

The learning models include: direct learning model, problem-based learning (PBM), Indonesian Realistic Mathematics Learning (PMRI). Another learning models are contextual learning, Index Card Match Learning and Cooperative Learning [6]. This learning model can be applied in the classroom on various subjects. One of the learning models applied is Problem Based Learning. Problem Based Learning is learning that organizes and plans resources and logistics to support student investigations [7]. Problem Based Learning is a learning model that uses real problems for students to learn about problem solving skills. In addition the students get essential knowledge and concepts from subjects [8]. Problem Based Learning is a learning model that starts from problems by maximizing resources through investigations to produce solutions.

In Islamic schools or where the majority of the students are Muslim, not all students carry out religious well. This is because Islamic religious lessons are only taught by religious teachers with a small number of lesson hours. Therefore, it is necessary to instill Islamic values in students by subject teachers. One alternative is to integrate Islamic values into subjects through integration of learning methods/models. Islamic values can be integrated into the Problem Based Learning model. The integration of Islamic values is done by connecting Islamic values to the subject matter or problems in class. Steps of Problem Based Learning model used to solve the problem related with everyday life and religious activity. Thus, it is hoped that real problem solving and the understanding of Islamic values will be obtained of students.

## **Discussion**

Many learning models have been developed which aim at improving the quality of learning. The quality of learning is characterized by the occurrence of the student learning process facilitated by the teacher. The term learning model refers to a particular approach to learning. The learning model covers objectives,

syntax/sequences, environment, and overall management system [9]. The learning model developed is a Problem Based Learning model. The main principle of Problem Based Learning is maximizing learning by investigating, explaining and starting from real problems. Problem Based Learning is the art of problem solving. Problem solving besides raising questions, also includes transfer of knowledge and process of producing solutions [10]. In Problem Based Learning, it becomes a means to train students' abilities in understanding problems [11]. In Problem Based Learning, the problem becomes the starting point in learning. In addition, students are trained to solve problems so that real problem solutions are obtained. In the problem solving process students are guided by the teacher so that the learning process is more focused.

The characteristics of Problem Based Learning are: 1) a student-centered approach, 2) empowering students to conduct investigations, 3) integrating theory and practice, and 4) applying knowledge and skills to solve problems [12]. The first step in Problem Based Learning is to pose a problem. Based on the problem, then concepts, principles and rules will be found. The problems posed are authentically aimed at spurring on real life [13]. The principle in PBL is to help students solve problems based on real life. Problem solving carried out through an investigation process by integrating theory and practice and empowering problem solving skills. Learning that uses Problem Based Learning emphasizes the ability of students to solve their own problems. The teacher pose a problem, student solve a problem guided by teacher.

To improve students' ability in problem solving through the process of presenting problems and investigating problems. Analyzing problems related to everyday life so that students will get used to solve real problems [14]. Problem Based Learning steps include orientation, organization, guidance, elaboration and presentation, analysis and evaluation [15]. This model can provide experience for students in identifying problems, collecting data, alternative problem solving, decision making [16]. Based on the opinions above, it can be concluded that, Problem Based Learning steps started of presenting the problem. The problem presentation is a problem related to everyday life. Thus the steps of the Problem Based Learning model include 1) presenting the problem, 2) describing the problem, 3) solving the problem, 4) presenting the results, and 5) concluding.

Students who attend on Islamic schools are expected to be able to practice their religion in everyday life. Therefore, students need to be given knowledge and practice of Islamic values associated with the subject matter. This is intended so that Islamic values are not only theoretical but can be applied in everyday life. Islamic values are religious values needed for their safety and happiness in this world and the hereafter [17]. Islamic education is an educational process carried out for students. The aim to gain knowledge and be able to implement teachings accompanied by Islamic values [18]. Islamic values are values that are sourced from the Qur'an and Hadith, to improve human character and behavior. The goal is that can bring people to prosperity, safety, and happiness in the world and the hereafter.

The integration of Islamic values in subjects through the Problem Based Learning learning model can be stated in the form of: 1) lesson plans, 2) learning steps, and 3) modules/ teaching materials. In the lesson plans, the steps of the Problem Based Learning model are presented in the learning steps in the presentation section. Islamic values are presented in the Islamic values column by quoting the verses of the Qur'an/Hadith related to the subject matter. In the implementation of learning, teachers teach using Problem Based Learning steps that are carried out individually or in groups. While Islamic values are given on the sidelines of explaining the material. Modules/teaching materials using the Problem Based Learning learning model integrated with Islamic values are presented in the form of: 1) presenting material in the form of excerpts from the Qur'an/Hadith and motivational verses, 2) presenting sample questions/practices related to religious life and Islamic values, 3) problem solving using Problem Based Learning steps, 4) presenting problems related to everyday life.

The following is an example of presenting an integrated Problem Based Learning learning model material on Islamic values. The steps of Problem Based Learning include 1) presenting the problem, 2) describing the problem, 3) solving the problem, 4) presenting the results, and 5) concluding.

### **Step 1. Presenting the Problem**

In a mosque, there are three walls that will be covered with wallpaper. If the first wall which has an area of 28 m<sup>2</sup> is covered with 2 rolls of type A paper, 3 rolls of type B paper and 2 rolls of type C paper. The second wall, which has an area of 14 m<sup>2</sup>, is covered with 2

rolls of A paper, 1 roll of B paper, and 1 roll of paper C. The last wall with an area of 26 m<sup>2</sup> is covered with 3 rolls of paper A, 2 rolls of paper B, and 2 rolls of paper C. What is the area of each roll of paper A, B, and C?

### Step 2 Describing the Problem

Note: The first wall with an area of 28 m<sup>2</sup> is covered with 2 rolls of type A paper, 3 rolls of type B paper and 2 rolls of type C paper. The second wall with an area of 14 m<sup>2</sup>, is covered with 2 rolls of A paper, 1 roll of B paper, and 1 roll of C paper. The last wall with an area of 26 m<sup>2</sup> is covered with 3 rolls of A paper, 2 rolls of B paper, and 2 rolls of C paper.

### Step 3: Problem solving

Question: What is the area of each roll of paper A, B, and C?

For example:

a is amount of paper A

b is amount of paper B

c is amount of paper C

Based on the above information obtained the following relationships

$$2a + 3b + 2c = 28 \quad \dots (1)$$

$$2a + b + c = 14 \quad \dots (2)$$

$$3a + 2b + 2c = 26 \quad \dots (3)$$

Solution:

Step a. Elimination of variable a in Eq. 1 and 2

$$\begin{array}{r} 2a + 3b + 2c = 28 \\ \underline{2a + b + c = 14} - \\ 2b - c = 14 \quad \dots(4) \end{array}$$

Step b. Elimination of variable b in Eq. 2 and 3

$$\begin{array}{r} 2a + b + c = 14 \quad | \times 2 | \quad 4a + 2b + 2c = 28 \\ 3a + 2b + 2c = 26 \quad | \times 1 | \quad \underline{3a + 2b + 2c = 26} - \\ \hline \therefore a = 2 \end{array}$$

Step c. Elimination of variable c in Eq. 1 and 3

$$\begin{array}{r} 2a + 3b + 2c = 28 \\ \underline{3a + 2b + 2c = 26} - \\ -a + b = 2 \quad \dots(5) \end{array}$$

Step d. Substitution the value  $a = 2$

$$-a + b = 2$$

$$-2 + b = 2$$

Then  $b = 4$

Substitute the values for  $a = 2$  and  $b = 4$  in equation 2, it is obtained

$$2a + b + c = 14$$

$$2(2) + 4 + c = 14$$

$$4 + 4 + c = 14$$

$$\text{So } c = 6$$

#### **Step 4. Presenting Results**

Based on the results of the problem solving, the area of one roll of paper A=2 m<sup>2</sup>, one roll of paper B=4 m<sup>2</sup> and one roll of paper C=6 m<sup>2</sup>.

#### **Step 5. Drawing conclusions**

The conclusion obtained based on the results of solving the problem obtained that the solution set is  $a = 2$ ,  $b = 4$ , and  $c = 6$ . In the example above, the steps for solving the problem are using the Problem Based Learning steps. Presentation of the problem in the form of problems related to religious activities and Islamic values. Learning can be done through face-to-face learning or online learning. In online learning, the technologies used are for example: WhatsApp, Zoom, Google Classroom and the Learning Moodle System (LMS). During the current Covid-19 pandemic, implementation of learning is mostly done in the form of offline and online learning. Offline learning be done with limited face to face, based on the government's policy to learn more from home. This is done to avoid the spread of the Covid-19 virus. In online learning we use information technology more so that it is related to the field of educational technology.

The study of educational technology includes areas to facilitate and improve learning performance through the creation, use, process management and technological resources. Activities to facilitate and improve learning performance are carried out in study and practice ethics. Study and learning practices through Problem Based Learning model integrated with Islamic values are part of improving learning performance. The purpose of this learning model is for students to increase their activities and learning outcomes. The activities carried out are problem solving activities related to daily life and instilling Islamic values in students. The Problem Based Learning

learning model integrated with Islamic values has an effect on higher order thinking skills and character strengthening [19]. Islamic values can be integrated in the learning process so that the learning has an Islamic nuance [20]. Thus, the use of the Problem Based Learning model integrated with Islamic values can be carried out by teachers in all subjects.

## Conclusion

The learning model is a systematic pattern or plan as a guide for teachers in learning activities. The applied of learning models can be done through offline or online learning. The learning model is one of the efforts to facilitate and improve learning performance. One type of learning model is Problem Based Learning model integrated Islamic values. This learning model aims to make students have problem solving skills and understanding of Islamic values. The learning steps are 1) presenting the problem, 2) describing the problem, 3) solving the problem, 4) presenting the results, and 5) concluding. The understanding of Islamic values is carried out by quoting verses from Qur'an/Hadith and presenting problems related to religion. The Qur'an and Hadith where quoted are related everyday life and motivational verses.

## References

- [1] I. I. Suherman, Musnaini, Hadion Wijoyo, *Industry 4.0 vs. Society 5.0*. Pena Persada, 2020.
- [2] M. Januszewski, Alan Michael, *Educational Techology*. Taylor & Francis, 2010.
- [3] D. H. Schunk, *Learning Theories, An Educational Perspective, Sixth Edition*. Boston: Alyn & Bacon, 2012.
- [4] Rusman, *Model-Model Pembelajaran: Mengembangkan Profesionalisme Guru*. Jakarta: Rajawali Pers, 2011.
- [5] Trianto, *Model Pembelajaran Terpadu*. Jakarta: PT Bumi Aksara, 2012.
- [6] S. S. I. Bruce Joyce, Emily Calhoun, *Models of teaching; A Working Professional Repertoire*. Katie Watterson of Electronic Publishing Service, 2019.
- [7] Rusmono, *Strategi Pembelajaran dan Problem Based Learning*. Bogor: Galia Indonesia, 2017.
- [8] R. Maskur *et al.*, "The effectiveness of problem based learning and aptitude treatment interaction in improving mathematical creative thinking skills on curriculum 2013," *Eur. J. Educ. Res.*, vol.

- 9, no. 1, hal. 375–383, 2020, doi: 10.12973/eu-jer.9.1.375.
- [9] R. L. Arends, *Learning to Teach*, Mimth edit. Americans: Mc Graw Hill, 2012.
- [10] A. Oğuz-Ünver dan S. Arabacıoğlu, “Overviews on inquiry based and problem based learning methods,” *West. Anatolia J. Educ. Sci.*, no. Selected papers presented at WCNTSE, hal. 303–310, 2011, [Daring]. Tersedia pada: [http://webb.deu.edu.tr/baed/giris/baed/ozel\\_sayi/303-310.pdf](http://webb.deu.edu.tr/baed/giris/baed/ozel_sayi/303-310.pdf).
- [11] J. Jailani, S. Sugiman, dan E. Apino, “Implementing the problem-based learning in order to improve the students’ HOTS and characters,” *J. Ris. Pendidik. Mat.*, vol. 4, no. 2, hal. 247, 2017, doi: 10.21831/jrpm.v4i2.17674.
- [12] J. Savery, “Overview Of Problem-based Learning : Devinition and Distinction Interdisciplinary,” *J. Probl. Learn.*, vol. 1, no. 1, hal. 9–20, 2006, [Daring]. Tersedia pada: <https://doi.org/10.7771/1541-5015.1002>.
- [13] R. Marlina, S. Nurjahidah, A. I. Sugandi, dan W. Setiawan, “Penerapan Pendekatan Problem Based Learning Untuk Meningkatkan Kemampuan Pemecahan Masalah Matematis Siswa Kelas Vii Mts Pada Materi Perbandingan Dan Skala,” *JPMI (Jurnal Pembelajaran Mat. Inov.*, vol. 1, no. 2, hal. 113, 2018, doi: 10.22460/jpmi.v1i2.p113-122.
- [14] Ratini, H. Muchtar, M. A. Suparman, A. H. Tamuri, dan E. Susanto, “The influence of learning models and learning reliance on students’ scientific literacy,” *J. Pendidik. IPA Indones.*, vol. 7, no. 4, hal. 458–466, 2018, doi: 10.15294/jpii.v7i4.12489.
- [15] N. R. Aini, S. Syafril, N. Netriwati, A. Pahrudin, T. Rahayu, dan V. Puspasari, “Problem-Based Learning for Critical Thinking Skills in Mathematics,” *J. Phys. Conf. Ser.*, vol. 1155, no. 1, 2019, doi: 10.1088/1742-6596/1155/1/012026.
- [16] Devy Alvionita, Prabowo, dan Z.A. Imam Supardi, “Problem Based Learning With The SETS Method To Improve The Student’s Critical Thinking Skill of Senior High School,” *IJORER Int. J. Recent Educ. Res.*, vol. 1, no. 3, hal. 246–260, 2020, doi: 10.46245/ijorer.v1i3.46.
- [17] S. M. Djamal, “Pelaksanaan Nilai-nilai Ajaran Islam Dalam Kehidupan Masyarakat Di Desa Garuntungan Kecamatan Kindang Kabupaten Bulukumba,” *J. Adab.*, vol. 17, no. 2, hal. 161–179, 2017, doi: 10.24252/jad.v17i1i2a5.
- [18] Z. Halid Hanafi, La Adu, *Ilmu Pendidikan Islam*. Yogyakarta:



Deepublish, 2019.

- [19] C. Anwar, "Efektivitas Pembelajaran Berbasis Masalah Terintegrasi dengan Nilai-Nilai Islam Berbasis TIK pada Keterampilan Berpikir Tingkat Tinggi dan Karakter Siswa," *J. Al-Ta lim*, vol. 23, no. 3, hal. 224–230, 2017.
- [20] S. Yuniati dan A. Sari, "Pengembangan Modul Matematika Terintegrasi Nilai-Nilai Keislaman melalui Pendekatan Realistic Mathematics Education (RME) di Propinsi Riau," *J. Anal.*, vol. 4, no. 1, hal. 157–165, 2018, doi: 10.15575/ja.v4i1.1588.

# **Development of Mathematical Learning Media Integrated Qur'an**

Syarifah Fadillah, Yadi Ardiawan, Rahman Haryadi

## **Introduction**

Learning media is an important part of learning activities at school. Through learning media, teachers will find it easier to teach and students will be more assisted and easier in learning. Learning media can be made in various forms according to the needs and characteristics of the teaching material to be taught. Appropriate learning media will help teachers to achieve the competencies set by the curriculum.

One of the characteristics of the 2013 curriculum is developing competencies that are expressed in the form of core competencies. Nuh [1] states that all subjects taught and studied in class must contribute to the formation of core competencies. It is further explained that core competencies are not to be taught, but to be formed through learning relevant subjects, each subject must be subject to the core competencies that have been formulated. In other words, all subjects taught and studied in the class must contribute to the formation of core competencies.

The first core competency in the 2013 curriculum reads: "appreciating and living up to the teachings of the religion they profess". This first core competency includes spiritual attitudes which are of course closely related to religious teachings. In schools, spiritual attitudes are generally formed through early learning activities by reading prayers before starting learning. A spiritual attitude is an obligation for teachers of all subjects to achieve it, including teachers of mathematics. In addition to being able to form a spiritual attitude in early learning activities, it can also be formed specifically through the design of instructional media.

Currently, textbooks are still the main source of information or teaching material in the learning process in schools. Textbooks are an integral part of mathematics learning and curriculum and play a major role as a learning resource for students. Teachers rarely use learning media in the implementation of the learning they do.

Based on the observations of researchers in schools, the mathematics textbooks used in Islamic schools are the same as the textbooks used in public schools. Likewise, the learning media used by teachers in Islamic schools have not used learning media that

integrate Islamic values in mathematics lessons. The same thing was found by previous researchers [2], [3], [4] states that the integration of Islamic values has been widely discussed but concrete implementation is needed in learning, because it requires a learning media to make it easier for teachers to implement Islamic values in their learning.

Bringing children closer to the values of the Qur'an in learning mathematics will make them understand the complete understanding of Islam in managing human life so that it will increase their faith. If this is done continuously in mathematics learning, spiritual competence will certainly be achieved. This is in line with the opinion of Saekan [5] which states that the religious dimension in the world of education means that education has a duty and responsibility to provide knowledge and understanding to humans to have a broad perspective on what Islam is and how to carry out Islamic teachings as a whole and thorough.

The pocket book is a learning medium that can be used in the learning process. A pocket book is a small book that can be stored in a pocket and easy to carry anywhere. The pocket book is small so that it is practical to carry anywhere, and can read anytime.

Researchers have made quite a lot of efforts to improve the learning process, including efforts to develop pocketbooks in various subjects as an effort to facilitate the achievement of competencies and learning objectives ([6], [7], [8]). This research tries to develop a pocketbook that is integrated with the verses of the Al-Qur'an in fraction material as an effort to achieve the first core competencies, including spiritual attitudes

## **Discussion**

### **Needs Analysis for Learning Media Development**

Implementation of the 2013 curriculum requires every teacher to integrate character education in the subjects they teach. Mathematics is a subject that is taught at every level of the school, including at Madrasah Tsanawiyah, it also has the same obligations. Every mathematics teacher is obliged to integrate character education in the learning process.

The 2013 curriculum contains core competencies and basic competencies. Core Competencies are designed in four interrelated groups, namely with regard to spiritual attitudes (core competence 1), social attitudes (core competency 2), knowledge (core competency 3), and skills (core competency 4). The four groups serve as a reference

for basic competencies and must be developed in an integrative way. Competence with respect to spiritual and social attitudes is developed indirectly (indirect teaching), namely when students learn about knowledge (core competency 3) and application of knowledge (core competency 4).

Competence with respect to spiritual and social attitudes is developed indirectly (indirect teaching), which is sometimes something that is often forgotten by teachers in the learning process. Therefore, learning media need to be specially designed so that spiritual and social attitudes are unforgettable and achievable. Based on this, the researchers developed learning media in the form of pocket books used in mathematics learning on fractions material, which were specifically designed so that spiritual attitudes can be achieved. The first core competency or spiritual attitude that will be formed through mathematics lessons is to appreciate and live up to the teachings of the religion they profess.

Madrasah Tsanawiyah as a special school for Muslim students, of course in the formation of spiritual attitudes, it is possible to link mathematics lessons with the values contained in the Al-Qur'an. Al-Faqih [9] states that the integration of Al-Qur'an values in mathematics learning can be done because the structure of the Al-Quran is a mathematical structure. Likewise, Huda [10] said that al-Qur'an contains the basic principles of science and civilization, which include natural sciences and mathematics. In addition, the use of learning media or teaching materials integrated with Islamic values can form student character ([11], [12], [13]). Therefore, the pocket book that the researcher developed to form this spiritual attitude is a pocket book that is integrated with the verses of the Al-Qur'an, especially regarding the material of fractions. This fraction material is taught in class VII Madrasah Tsanawiyah.

### **Integration of Al-Qur'an Verses in Mathematics Learning**

The integration of Islamic values into the learning process can be done by connecting the verses of the Qur'an with the concepts being studied [14]. Some Islamic scientists have even used Al-Qur'an verses to develop mathematics itself [15]. This study takes fractions material which in the learning process is integrated with Al-Qur'an verses. Fractions material is a mathematical material that is contained in many verses of the Qur'an, including in the law of inheritance and the law of zakat. In the development of learning media in the form of a pocket book in this study, the researcher linked fraction material

with the law of inheritance.

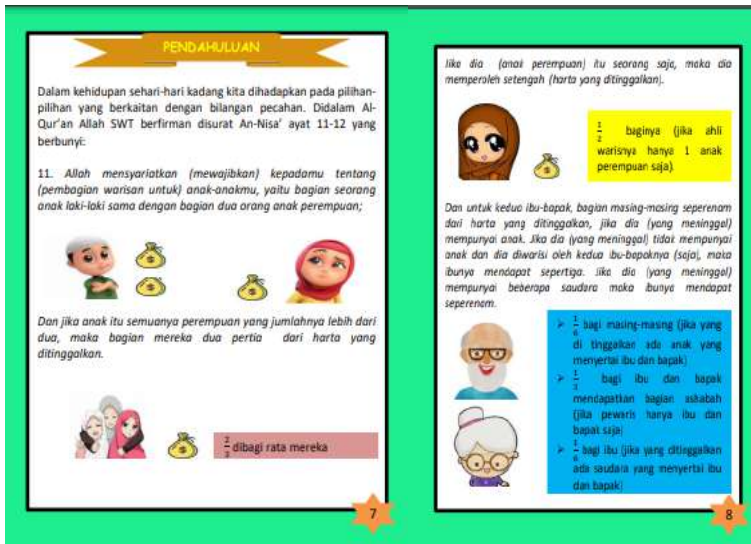
Kusno [16] states that Islamic spiritual values can be contained both in the presentation of material, evaluation of mathematics learning, and in learning methods. In this research, the researcher used Al-Qur'an verses regarding inheritance law in the presentation of the material. Abdussakir [4] states that this form of integration is "mathematics from Al-Qur'an". In this integration model, mathematics is learned and developed from Al-Qur'an. Explicit mathematical concepts in Al Qur'an such as numbers, number relations, number operations, ratios and proportions, sets, and measurements are used as the initial basis for explaining or developing mathematics.

The integration of the verses of the Qur'an in this pocket book is divided into three parts, namely the cover of the pocket book, the introduction section, and the material section. In the cover part is written QS al Qomar verse 32 which means: "And in truth We have made the Qur'an easy to remember; but is there any that remembered?" This is to motivate students to continue to understand the verses of the Qur'an as a guide for the life of a Muslim. Following is the pocket book cover that was developed.



Figure 1: Cover Pocket Book

In the introduction, students are introduced to the concept of fractions through QS An-Nisa verses 11 and 12. Following are some of the pictures of the introduction.



**Figure 2: The Introduction Section**

Through this verse students are introduced to fractions through the procedure for distributing inheritance assets based on the provisions of Islamic law, including that the share of a boy is the same as two parts of a girl. Through these two verses, students are introduced to the concept of fractions  $\frac{1}{2}$ ,  $\frac{1}{3}$ ,  $\frac{1}{4}$ ,  $\frac{1}{6}$ ,  $\frac{1}{8}$ , and  $\frac{2}{3}$ .

Furthermore, the integration of Al-Qur'an verses is contained in the material, especially in providing sample questions and practice questions. Here are some sample questions and practice questions given in the pocket book.

1. A woman dies with the heir of a husband who receives  $\frac{1}{4}$  part of the inheritance, a mother who gets  $\frac{1}{6}$  part, and a son who gets all the remainder of the share that has been divided between husband and mother. The inheritance left behind is IDR 150,000,000. Calculate the share of each of these heirs!
2. A man dies and the heir is a wife who gets  $\frac{1}{8}$  part, a daughter who gets  $\frac{1}{2}$  part, a mother who gets  $\frac{1}{6}$  part, and an uncle will receive all the remainder of the assets that have been distributed to his wife, daughters and mothers, which is 5 portions. The assets left behind are IDR 96,000,000. How much share does each heir get?

3. An inheritance problem in Tanjung village has a case with the heir of a husband who gets  $\frac{1}{4}$  of the inheritance, a mother who gets  $\frac{1}{6}$  of the inheritance, and a son who gets all the remaining shares of the inheritance, which is 7 parts of the assets left behind. The assets left behind are IDR 150,000,000. What is the share of each of these heirs?

The questions in the pocket book directly mention the division of inheritance in the form of fractions because in this case the aim of learning mathematics in this fraction material is not to teach students the division of inheritance, but to provide students with understanding of operations on fraction numbers. The material for fractions is given in the form of everyday problems related to inheritance law with the hope that students will get to know the comprehensive Islamic concept so that students will appreciate the teachings of their religion more. Mufid [17] in his study concluded that the dichotomy between Islamic and secular sciences causes scientists to try to integrate the two because they have a positive impact on life.

### **Implementation of an Integrated Pocket Book of Qur'an Verses in Mathematics Learning**

The pocketbook that had been designed was then validated by three mathematicians as well as experts who understand the integrated learning media of Al-Qur'an verses. The media validity assessment was adopted from BNSP which has four aspects of assessment, namely: (1) content feasibility aspect, (2) language feasibility, (3) presentation feasibility, and (4) graphic feasibility.

The three experts provided suggestions, including simplifying the sample questions and exercises to suit the junior high school students' abilities, some picture displays, and also the use of language. The mean score of the three experts for all aspects of the assessment is 68 which is classified as very valid. After fixing the media according to expert advice, the learning media were then tried out at MTs Negeri 2 Pontianak.

Students who learn using the pocket book media are then given a questionnaire to assess the practicality of the learning media developed according to the user's opinion. The results of the questionnaire analysis showed that the average student assessment of the pocket book media was sixty-two which was classified as very practical, so that this pocket book was stated to be used in mathematics learning, especially in fractions material.

Students using pocket book media stated that the material and language presented in the pocket book were easy to understand. The selection of layouts, colors, and pictures in the pocketbook is attractive, thereby increasing student interest in learning. Students also stated that the existence of quoting Al-Qur'an verses in pocket books increased their curiosity about mathematics and Al-Quran. Students also said that the fractions material presented by linking them to the verses of the Qur'an added to their knowledge. This is in line with the research of Choirudin, et al [18] and Winarso and Wahid [19] who developed student worksheet learning media, namely students feel interested in learning by using student worksheets that are linked to Islamic values.

The development of various learning tools and mathematics learning media that are integrated with Islamic values has begun to be developed by Muslim researchers. However, this development is carried out partially in certain materials. If the results of this study are developed integrally for all mathematics material at a certain school level, it will produce a mathematics textbook that can be used by teachers in Islamic schools as a means for students to get closer to the values of the Qur'an, so that students can appreciate, live, and practice the teachings of Islam.

## **Conclusion**

This research has developed a pocketbook that is integrated with the verses of the Al-Qur'an in fraction material as an effort to achieve the first core competencies, including spiritual attitudes. The results showed that: (1) based on expert judgment, the pocket book developed was valid and suitable for use in the field and (2) based on student response questionnaires, this pocket book was practically used for learning mathematics.

## **References**

- [1] M. Nuh, "Kurikulum 2013," 2013. [Online]. Available: <https://edukasi.kompas.com/read/2013/03/08/08205286/Kurikulum.2013?page=all>.
- [2] A. Rahmawati and R. Swaditya, "Pengembangan Bahan Ajar Matematika Berbasis Nilai-Nilai Islam Pada Materi Aritmatika Sosial," *Aksioma Jurnal Program Studi Pendidikan Matematika*, vol. 6, no. 1, pp. 81–88, 2017.
- [3] S. Haryati, A. Hartoyo, and A. Nursangaji, "Pengembangan Modul Matematika Bersumber Al-Qur'an dengan Materi Perbandingan



- di Kelas VII SMP/Mts,” *Jurnal Pendidikan dan Pembelajaran Khatulistiwa*, vol. 8, no. 10, pp. 1–11, 2019.
- [4] Abdussakir, “Integrating Mathematics and Religious Teachings and Values In Elementary and Secondary School,” Mataram, 2018, pp. 1–10.
- [5] M. Saekan, “Islamic Education Unifying Nation,” *Qudus International Journal of Islamic Studies*, vol. 5, no. 2, pp. 102–116, 2017.
- [6] M. Masita and D. Wulandari, “Pengembangan Buku Saku Berbasis Mind Mapping pada Pembelajaran IPA,” vol. 8, no. 12, pp. 191–198, 2018.
- [7] N. N. Muhamad, A. M. Taiyeb, and A. A. Aziz, “Development of Pocket Book at the Respiratory System Subject for Senior High School Grade XI,” in *Proceeding Biology Education Conference*, 2015, pp. 162–167.
- [8] N. Nindarti, Suherman, and S. Anwar, “Improving of Trigonometry Concept Based on Islamic Value Trough Pocket Book,” *Inovasi Pembangunan-Jurnal Kelitbangan*, vol. 6, no. 3, pp. 291–300, 2018.
- [9] K. M. S. Al Faqih, “A mathematical Phenomenon in the Quran of Earth-Shattering Proportions: A Quranic Theory Based on Gematria Determining Quran Primary Statistics (words, verses, chapters) and Revealing its Fascinating Connection with the Golden Ratio,” vol. 6, no. 6, pp. 52–73, 2017.
- [10] N. Huda, “Geometry and Measurement in Quran,” *Al-Jabar: Jurnal Pendidikan Matematika*, vol. 11, no. 2, pp. 307–316, 2020.
- [11] J. Ahmad, I. Handayani, and S. Rizki, “Development of learning material of integer and fractions based on interactive multimedia with islamic values,” *Journal of Physics: Conference Series*, vol. 1517, p. 012083, Apr. 2020, doi: 10.1088/1742-6596/1517/1/012083.
- [12] M. Istiqlal and Jumadi, “Strengthening Islamic character through Mathematics learning,” *Mudarrisa: Jurnal Kajian Pendidikan Islam*, vol. 9, no. 2, pp. 188–207, 2017.
- [13] L. Listyono, K. Supardi, N. Hindarto, and S. Ridlo, “Methods of integrating Islamic values in teaching biology for shaping attitude and character,” *Journal of Physics: Conference Series*, vol. 983, p. 012178, Mar. 2018, doi: 10.1088/1742-6596/983/1/012178.
- [14] A. Y. Nuryantini, Karman, and A. Holik, “Integration Science and Religion Physic Subject: An Analysis in Islamic Higher

- Education," *Tarbiya: Journal of Education in Muslim Society*, vol. 5, no. 1, pp. 11–18, 2018.
- [15] L. K. A. Husain and R. A. Faizin, "Contributions of Islamic Civilization to The Mathematics Development," *Wawasan: Jurnal Ilmiah Agama dan Sosial Budaya*, vol. 2, no. 2, pp. 199–208, 2017.
- [16] Kusno, "Analysis of Islamic Spiritual Values in Mathematics Education," *Advances in Social Science, Education and Humanities Research (ASSEHR)*, vol. 109, pp. 150–159.
- [17] F. Mufid, "Islamic Sciences Integration," vol. 2, no. 2, pp. 144–160, 2014.
- [18] Choirudin, E. F. Ningsih, M. S. Anwar, A. Choirunnisa, and A. Maselena, "Developing Mathematical Students Worksheet Based On Islamic Values Using Contextual Approach," *International Journal on Emerging Mathematics Education*, vol. 3, no. 2, pp. 152–161, 2017.
- [19] W. Winarso and S. Wahid, "Development of Mathematics Teaching Device Integrated with Quranic Values: Issues, Challenges, and Implementation Model," *International Journal of Learning, Teaching and Educational Research*, vol. 19, no. 1, pp. 95–117, 2020.

# Literacy Program in Madrasah: Challenging Lagging

Taufiqur Rahman<sup>113</sup>, Moh. Zamili<sup>114</sup>

## Introduction

The Indonesian literacy ranking published by PISA in 2018 is 72 out of 79 countries. This ranking has not changed from the previous period (2015), 67 out of 73 countries, although the national literacy movement started in 2015 [1]. The 2016 AKSI results show that the reading ability of Indonesian students is 55.85% (low), 38.01% (enough), and 6.14% (good). The term "less" means that students can find and retrieve explicit information in the discourse and interpret a text. "Medium" means that students can make interpretations of the implicit information in the text; able to make conclusions from the results of the integration of some information in a text. "Good" means that students can integrate some information across texts; evaluate the content, quality, way of writing a text; be reflective of the content of the text. Literacy is an indicator of the development of a nation. This level of student reading ability is a signal of a learning crisis or the low quality of Indonesian education.

Today, the meaning of literacy is not limited to reading and writing literacy. It also includes reading texts that vary according to subject, genre, level of language complexity, accessing information, and then expressing it in verbal and written form in participating in various kinds of social life. In addition, literacy is a medium in learning to reflect, investigate, and criticize the knowledge and ideas learned [2]. The breadth of literacy coverage is manifest in various forms of activities in madrasahs, namely: providing reading and expression facilities, utilizing the environment as a learning resource, inquiry learning approach, and Minimum Competency Analysis. However, the implementation of various programs related to literacy is carried out in an incomplete and unsustainable manner.

Researchers and policymakers examine this literacy program from various aspects. The implementation of the literacy program is studied either partially, the habituation aspect [3] or development and learning [4]. Madrasahs creatively add religious literacy activities, namely reading the Qur'an before learning [5]. Expression in the form

---

<sup>113</sup> Universitas Ibrahimy, [taufiqurrahman.info@gmail.com](mailto:taufiqurrahman.info@gmail.com)

<sup>114</sup> Universitas Ibrahimy, [fine.zam@gmail.com](mailto:fine.zam@gmail.com)

of literary works in the form of short stories and poetry [6], as well as the transformation of old wise advice in their own language carried out by students [7], is literacy in a new meaning, literacy as a social practice [8]–[11] or termed new literacy [12], [13]. Research initiated the study of literacy content in textbooks, including scientific literacy in thematic books [14] and the development of text-rich teaching materials [15] as student literacy readings. In addition, the library uses the Big6 model [16], [17] in providing services to teachers and students. Library services become an integrated part of learning and creating a text-rich environment for students' reading habits outside the classroom [18], [19].

The literacy movement program is a government initiative to improve the competitiveness of Indonesian education. The ranking of reading, math, and science skills issued by international institutions is not a concern of learning actors in academic units. The implementation of the government's 'innovation' needs to pay attention to (1) the level of concern and (2) the level of use of innovation [20], [21]. In addition, environmental and library management integrated with learning activities needs further study. At the learning stage, the aspects of assessment and learning reflection did not get the researchers' attention on literacy. Theoretically, these two aspects are the first step to carrying out successful literacy activities in learning [22], [23].

The explanation above indicates further studies on literacy practices in madrasas according to the target to achieve. Those aspects of the level of concern and performance of literacy implementation, management of the academic environment; interaction between students, students, and teachers in literacy activities; reports on literacy assessment practices; learning reflection related to literacy and literacy integration in curriculum development madrasah. Researchers view the level of concern, environmental management, 'literacy in context are critical aspects of the success of the literacy program. Support for theoretical studies based on meta-analytical procedures is urgently needed, considering the absence of a theoretical foundation for literacy in madrasas. It is undeniable that madrasas' literacy practices are unique because they have religious characteristics. Religious content presents a side of willingness, piety, and specialness not found in schools.

## **Discussion**

### **The spectrum of literacy meaning**

The implementation of literacy in madrasas is a view in a broad and integrative spectrum. Literacy activities are not just 'cognitive phenomena,' namely mental conditions and processes: reading and writing are seen as processes in the head. The new literacy perspective emphasizes literacy as a way to participate in socio-cultural groups, not just a cognitive phenomenon [12], [24]–[26]. This literacy spectrum is intertwined in creating a literacy atmosphere in madrasas, integration in learning activities with an inquiry learning approach, the use of the environment as a learning resource, and assessment and reflection on learning. The student learning experience is a series of literacy activities interlinked between madrasas and real life. The phenomenon of literacy in the learning experience frame for madrasas is to raise the image to avoid being left behind.

Madrasah infrastructure facilities are managed to support literacy activities. The placement of reading corners in every classroom and other reading places in the madrasa environment, wall magazines as a medium for displaying student writing, and library services are prerequisites for a madrasa environment that supports the creation of a literacy climate. In addition to aspects of the physical environment [27], social, affective and academic domains were added. The social environment is formed through interaction and communication in the madrasa. Positive interaction between madrasa residents and open communication will create a conducive situation for literacy activities. The affective environment describes a sense of belonging. Students, teachers, staff, parents feel valued and respected. They are seen as important for the achievement of madrasa goals. Lastly, the academic environment. Students have high expectations and are expected to succeed. Teachers will observe student progress and adjust their teaching methods to facilitate student success.

Learning activities in the classroom should allow students to read or access information related to the subject matter. Learning that requires students to actively participate in learning and encourages students to explore new knowledge is a literacy activity that impacts cognitive development and skills to access, select, sort out relevant information. Miller and Veatch [23] call it "literacy in context," including assessment, reflection, planning, and teaching/reteaching cycles. Strategy selection is carried out at the planning stage based on the results of assessment and reflection [22]. Literacy activities in

learning are not enough to ask students to read before and during learning. However, it also assesses literacy achievements based on the planned literacy indicators. The learning strategy deemed relevant to the literacy and curriculum needs is disclosure/research-based learning [28].

Assessment and reflection are critical stages of literacy success. Assessment is carried out by staff and teachers. Assessment by the team to identify the level of success of the literacy program based on indicators and characteristics of the literacy movement in each madrasa [29], [30]. The teacher's assessment occurs at the time (formative) and at the end (summative) of learning. The aspects assessed are reading and understanding of various texts [31]–[33]. After learning, the teacher writes the reflection of learning in a journal. Regarding remedial, it depends on the characteristics of the basic competencies determined by taking into account the minimum completeness criteria. This assessment and reflection data is the first step in the continuous improvement of student literacy achievement in the context of learning.

### **Concern-Based Adoption Model**

The CBAM model was developed by the University of Texas Research and Development Center led by Gene Hall. This model proposes three dimensions to identify and explain changes in individual teachers, namely the stage of concern (SoC), level of use (LoU), and Innovation Configuration. The awareness stage is a framework that describes a teacher's sense and motivation for change in the various stages of implementation. Hall and colleagues classify this stage into seven levels; awareness, informational, personal, management, consequence, collaboration, and refocusing. The description in the SoC helps to identify changes in the individual in response to the implementation of literacy programs in madrasas.

Level of Use (LoU) focuses on general patterns of teacher behavior when preparing, starting to use, and gaining experience implementing literacy programs. The use of innovations carried out by madrasas is classified as non-use, orientation, preparation, mechanical, routine, refinement, integration, and renewal. Changes in the level of teacher use are not linear; teachers can go up and down due to the situation in the implementation of the program. Innovation configuration (IC) is a framework to provide an overview of the suitability of implementing literacy programs. The teacher applies for the program by making creations that may still be categorized as in

accordance with or judged to be out of the program track that is laid down. The IC study will find patterns in the application of innovation by teachers. Variations in the implementation of literacy programs, qualitatively, are unique and will enrich the program's implementation. However, of course, this must take into account the program criteria.

### **Concern and Performance of Literacy Actors in Madrasah**

This section describes the profile of concern and performance of madrasah residents towards the implementation of the School Literacy Movement policy. The level of concern and performance profile of madrasah residents is seen as having a causal relationship, or in other words, the concerns of madrasah residents that have an impact on their performance in carrying out literacy programs in madrasahs. The performance will be seen through three stages of literacy, namely habituation, development, and learning. Conceptions and abstractions obtained from the data will then be dialogued with existing theories, especially the learning innovation implementation model proposed by Hall [34], the Concern-Based Adoption Model. The assumptions underlying this model are (1) change is a process; (2) changes are made by individuals; (3) change is an individual experience; (4) change involves development in feelings and skills; and (5) change can be facilitated through direct intervention with individuals, innovations and related contexts [35]. In addition, the concepts found will be compared with credible research results to determine the position of this research in the broader research context.

### **Literacy Environment in Madrasah**

This section describes the various environmental categories found. The madrasah environment can be classified into four groups: the physical environment, social environment, affective environment, and academic environment. This environment identification is in line with the guidelines for the School Literacy Movement at the elementary, junior high, and high school levels. This classification will be compared with field facts and theoretical perspectives. Theoretically, the environmental aspect is a determining factor in creating a conducive social environment for the development of a literacy culture [27]. The physical environment provides the tools needed to create a text-rich climate and student space for expression. Expression as a response to the problems faced by students is seen as

a social practice [8]. The social environment describes the interaction and communication between madrasa residents and external parties, including parents. The affective environment describes the concern, appreciation, and mutual respect of madrasah residents, which has implications for a sense of belonging to the literacy program.

### **Literacy in the context of learning in Madrasah**

Literacy in context is a term proposed by Miller and Veatch [23]. This section will describe literacy activities carried out in the classroom or in the context of learning. This activity includes learning planning, including literacy activities, implementation of literacy in classrooms or in the context of learning, literacy assessments both process (formative) and final (summative), and reflections or teacher notes related to the learning practices carried out. Literacy dialogue in context is a wilderness of learning that cannot be separated from selecting learning strategies relevant to curriculum objectives. The study in this section will relate to scientific approaches (not syntax), deeper learning methods, character education, XXI century skills, and Minimum Competency Assessment (AKM).

### **Conclusion**

The literacy program was developed to respond to the skills needed in the 21st century and the facts of Indonesia's PISA rankings. Mainstreaming reading and numeric literacy is to accelerate the competitiveness of Indonesian students globally. Studies of literacy activities in madrasahs tend to be 'evaluative' or highlight creative aspects in their implementation, not entirely in line with program objectives. Literacy studies must be viewed from the concerns of policy objects and literacy dimensions, namely cognitive, environmental, and learning processes. The results of identifying the level of concern are used to provide relevant treatment or assistance. Literacy activities in madrasahs are explained through (1) changes in thinking behavior (knowledge) due to reading activities; (2) the use of the environment as a learning resource, as well as a space that facilitates literacy activities and student literacy expression spaces; and (3) integration in learning activities both before, during learning and reflection at the end of learning activities.



## References

- [1] Permendikbud, *Peraturan Menteri Pendidikan dan Kebudayaan Republik Indonesia Nomor 23 Tahun 2015 Tentang Penumbuhan Budi Pekerti*. 2015.
- [2] Kementerian Pendidikan dan Kebudayaan, *Peta Jalan Gerakan Literasi Nasional*. Jakarta: Kementerian Pendidikan dan Kebudayaan, 2017.
- [3] M. Ö. Danacı and A. İ. Yükselen, "The Effect of Child Activity on the Habituation Attitude of Reading Book which of Child's Parents," *Procedia - Soc. Behav. Sci.*, vol. 152, pp. 1207–1213, Oct. 2014.
- [4] D. Surwanti and I. Hikmah, "Improving Students' Awareness of Functional Literacy," *English Lang. Teach. Educ. J.*, vol. 2, no. 2, pp. 79–89, 2019.
- [5] K. Khulusinniyah and M. Zamili, "LITERASI AGAMA PADA ANAK MELALUI PROGRAM PEMBIASAAN PRAKTIK IBADAH," *Edupeedia J. Stud. Pendidik. dan Pedagog. Islam*, vol. 5, no. 2, pp. 47–56, Mar. 2021.
- [6] Israpil, "Karya Sastra: Ekspresi Literasi Peserta Didik Di Madrasah Aliyah Negeri 1 Bone," *Pusaka J. Khazahan Keagamaan*, vol. 7, no. 1, pp. 63–82, 2019.
- [7] A. Muslim, "Curhat di balik laci: Ekspresi Literasi Siswa di Madrasah Aliyah PESRI Kendari," *Al-Qalam*, vol. 25, no. 1, p. 211, Jul. 2019.
- [8] G. Kress and J. Rowsell, "Literacy As A Social Practice," in *Re-Theorizing Literacy Practices: Complex Social and Cultural Contexts*, New York: Routledge, 2018, pp. 30–49.
- [9] J. W. Miller and M. C. McKenna, *World Literacy: How Countries Rank and Why It Matters*. Routledge, 2016.
- [10] D. Barton and M. Hamilton, "La littératie: Une pratique sociale," *Lang. Soc.*, vol. 133, no. 3, pp. 45–62, Sep. 2010.
- [11] J. Rowsell, G. Kress, K. Pahl, and B. Street, "The Social Practice of Multimodal Reading," in *Theoretical Models and Processes of Literacy*, Routledge, 2019, pp. 514–532.
- [12] J. P. Gee, *New Digital Media and Learning as an Emerging Area and "Worked Examples" as One Way Forward*. Cambridge, Massachusetts: The MIT Press, 2018.
- [13] V. Purcell-Gates, *Cultural Practices of Literacy: Case Studies of Language, Literacy, Social Practice and Power*, 3rd ed. Routledge Taylor & Francis, 2020.

- [14] K. Metafisika and Husni Abdillah, "Metode Analisis Muatan Literasi Sains pada Buku Ajar Tematik Sekolah Dasar/Madrasah Ibtidaiyah (Studi Deskriptif Pada Buku Tematik Kelas 4 Tema 1)," *JIEES J. Islam. Educ. Elem. Sch.*, vol. 1, no. 2, pp. 111–119, Dec. 2020.
- [15] J. Alfin, "Pengembangan Materi Sejarah Kebudayaan Islam sebagai Bahan Ajar Literasi Membaca di Madrasah Ibtidaiyah," *J. Pendidik. Agama Islam (Journal Islam. Educ. Stud.*, vol. 7, no. 1, pp. 71–88, 2019.
- [16] E. M. Eisenberg, H. L. Goodall, and A. Trethwey, *Organizational Communication: Balancing Creativity and Constraint*, 6th ed. Boston: Bedford / St. Martin's, 2010.
- [17] M. B. Eisenberg, J. Murray, and C. Bartow, *The Big6 Curriculum: Comprehensive Information and Communication Technology*. ABC-CLIO, 2016.
- [18] E. M. Meyers, I. Erickson, and R. V. Small, "Digital literacy and informal learning environments: An introduction," *Learn. Media Technol.*, vol. 38, no. 4, pp. 355–367, Dec. 2013.
- [19] R. Hobbs and J. Coiro, "Design Features of a Professional Development Program in Digital Literacy," *J. Adolesc. Adult Lit.*, vol. 62, no. 4, pp. 401–409, Jan. 2019.
- [20] D. P. Thomas, S. Emery, V. Prain, J. Papageorgiou, and A. M. McKendrick, "Influences on local curriculum innovation in times of change: a literacy case study," *Aust. Educ. Res.*, vol. 46, no. 3, pp. 469–487, Jan. 2019.
- [21] C. D. Ennis, "Knowledge, transfer, and innovation in physical literacy curricula," *Journal of Sport and Health Science*, vol. 4, no. 2. Elsevier, pp. 119–124, 01-Jun-2015.
- [22] M. Miller and N. Veatch, *Literacy in Context (LinC): Choosing Instructional Strategies to Teach Reading in Content Areas for Students Grades 5-12*. Boston: Allyn & Bacon, 2011.
- [23] M. Miller and N. Veatch, "Teaching Literacy in Context: Choosing and Using Instructional Strategies," *Read. Teach.*, vol. 64, no. 3, pp. 154–165, 2010.
- [24] C. Barratt-Pugh, "The socio-cultural context of literacy learning," in *Literacy learning in the early years*, Routledge, 2020, pp. 1–26.
- [25] B. Parry, "Popular culture, participation and progression in the literacy classroom," *literacy*, vol. 48, no. 1, pp. 14–22, Apr. 2014.
- [26] J. Blackmore and K. Hutchison, "Ambivalent relations: The 'tricky footwork' of parental involvement in school communities," *Int. J. Incl. Educ.*, vol. 14, no. 5, pp. 499–515, Aug. 2010.

- [27] C. S. Beers, J. W. Beers, and J. O. Smith, *A Principal's Guide to Literacy Instruction (Tools for Teaching Literacy)*. London: The Guilford Press, 2010.
- [28] Menteri Pendidikan dan Kebudayaan, "Peraturan Menteri Pendidikan dan Kebudayaan Republik Indonesia Nomor 22. Tahun 2016." Direktur Jenderal Peraturan Perundang-Undangan Kementerian Hukum dan Hak Asasi Manusia Republik Indonesia, 2016.
- [29] Y. Xu and G. T. L. Brown, "Teacher assessment literacy in practice: A reconceptualization," *Teach. Teach. Educ.*, vol. 58, pp. 149–162, Aug. 2016.
- [30] K. H. Koh, "Improving teachers' assessment literacy through professional development," *Teach. Educ.*, vol. 22, no. 3, pp. 255–276, Sep. 2011.
- [31] B. Comber, "Mandated literacy assessment and the reorganisation of teachers' work: Federal policy, local effects," *Crit. Stud. Educ.*, vol. 53, no. 2, pp. 119–136, Jun. 2012.
- [32] M. DinanThompson and D. Penney, "Assessment literacy in primary physical education," *Eur. Phys. Educ. Rev.*, vol. 21, no. 4, pp. 485–503, May 2015.
- [33] T. Levi and O. Inbar-Lourie, "Assessment Literacy or Language Assessment Literacy: Learning from the Teachers," *Lang. Assess. Q.*, vol. 17, no. 2, pp. 168–182, Mar. 2020.
- [34] G. E. Hall, "The Concerns-Based Adoption Model: A Developmental Conceptualization of the Adoption Process within Educational Institutions," in *the Annual Meeting of the American Educational Research Association*, 1974, pp. 1–23.
- [35] S. E. Anderson, "Understanding teacher change: Revisiting the Concerns Based Adoption Model," *Curric. Inq.*, vol. 27, no. 3, pp. 331–367, 1997.

# **EFL Teaching Innovations in Indonesia**

Tono Suwartono, Retno Ayu Cahyaningtyas

## **Introduction**

As the most international language nowadays, English has surely always become one of the most wanted languages on Earth according to several surveys. However, with regard to its status as a foreign language, it is not a simple matter to learn the language in Indonesia [1],[2]. It is also quite challenging for educators to teach the language in this context [3]. In spite of the fact that it is learnt for nearly ten years from primary schools through secondary schools, most Indonesian learners of English have not achieved proper English proficiency [4]. The English teachers also admit that it is very hard to take the students to a better attainment [3].

One component of education that is most expected to be able to contribute solution is of course the teacher, due to their central roles and strategic position [5]. Teachers typically serve a learning facilitator. They are also frontliners, directly dealing with students. Besides, they are expected to assist them in developing learner autonomy, so that learning extends to outside of schools. Learner autonomy is even crucial in a foreign language learning context [6].

Within and beyond the academic settings, technology has advanced very rapidly [7]-[9]. This advancement takes place in every sector of life, including the one deliberately developed by experts to assist language learning as well as the one that authentically exists and help people learn a language informally. In this era, Indonesian learners of English are exposed to technology with a huge English content [10]. Via internet they found unlimited both written and spoken English texts. Their computers and gadgets which are connected to the internet allow them to develop reading, writing, comprehending, and speaking English skills [11].

Subconscious learning of English is seen in some daily activities. Some people love going online shopping. They purchase things there with lots of transactions done in English. Some prefer operating M-Banking to do some transaction. People in many countries now make use of online transportation for short distance trips. In the online system, standard messages and notifications are given in English. In addition, a revolutionary change in information sharing is available in the internet. People can browse the internet for any information they are looking for by googling. Of course, this

happens to involve English as the number one language over the globe. Last but not least, social media, such as Facebook and Instagram, are part of people's way of life. Those media serve as the greatest networks in today's world. Those all things are made available for a specific purpose in particular areas of life. But still, they help people learn a language, in this case, English as the most international language.

With regard to the condition mentioned above, two questions are worth putting forward. In the first place, what sorts of most current technology are intentionally created to help people learn English? Then, how are the technological innovations utilized in English language teaching and learning in Indonesia? Answers to these questions will be given in the next section.

## **Discussion**

### **Latest Advancement in English Language Teaching Technology**

Utilization of technology nowadays is identical to the use of digital wares and the internet accessible anywhere and anytime. The digital wares that progress very rapidly and become more complicated and specific have a very incredible advantage to teachers as well as learners, including those of English. The fast advancement of the internet along with innovation support in many corners of the globe has resulted in super rich learning resources. A variety of online learning applications that we can enjoy now constitute one of the contributions within the society 5.0 era. As language educators, teachers of English should maximize their competence in keeping with this technology [12],[13].

In order to effectively achieve the learning objective, an English as a foreign language (henceforth abbreviated as EFL) teacher should be able to integrate four language skills of listening, speaking, reading and writing well in their instruction [14]. In dealing with technology for education the following are some selected sample of online applications that can be utilized by EFL teachers to assist students in developing their English proficiency. Others are not presented due to limited space. Language laboratories with its CALL (Computer Assisted Language Learning) was developed earlier and is not discussed here.

### **Breaking News English**

This application is a web-based application that can help students in various English skills, such as listening, reading, and

writing. This application provides various topics and written stories equipped with audio for students to listen to. And to train students' understanding, this application is also accompanied by various



questions. Each material presented is also equipped with audio recordings that can be adjusted to the speed level and also the pronunciation style is available in British English and American English to practice the pronunciation of users [15].

**Figure 1. Breaking News English initial screen display**

Here is an example of the text in this application:



**Figure 2. A sample text for reading comprehension**

Audio variants are also provided according to the abilities of the students.



Figure 3. Audio features to select

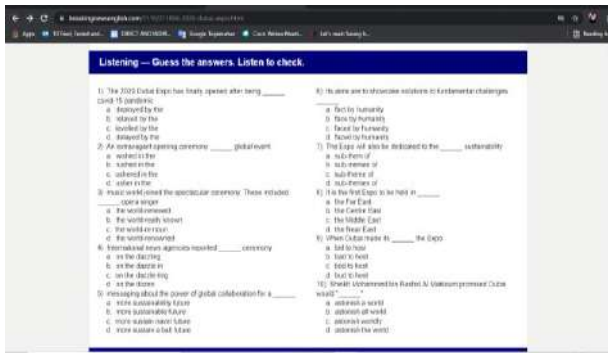


Figure 4. Listening test questions

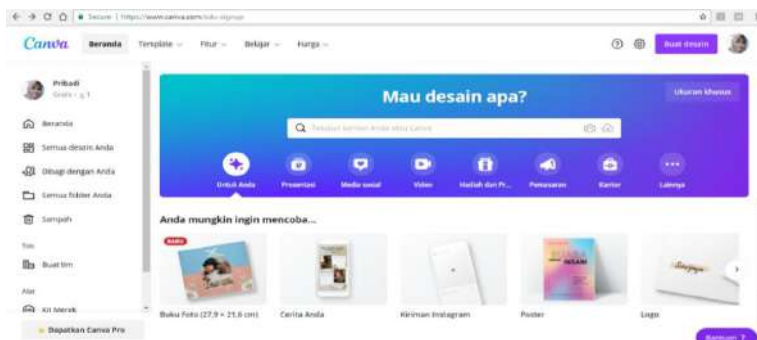
Figure 4 is an example of a question to test students' understanding. Actually there are lots of practice questions that can be done by students from each topic or title of the story.

The use of [www.breakingnewsenglish.com](http://www.breakingnewsenglish.com) is very suitable for users who want to enrich the lexicon and learn common and situational vocabulary in context [15].

### Canva

Canva is an online application that is useful to serve as media for design making, such as presentation, poster, pamphlet, brochure, graphs, infographics, etc. Canva is a popular tool for users looking to express abstract ideas into concrete maps [16]. Concerning the instructional media, EFL teachers and students can create presentations, make resumes, and present their ideas and works

interestingly. Many ready-for-use features to produce awesome presentations such as thousands of template, pictures, videos, and charts grafik can be made use to support the presentation content. Furthermore, teachers and students as users may find it exciting to work collaboratively in teams for a shared document all at the same



time. In addition, users may record a presentation and share it in MP4 format to others. To use Canva, users simply download it for free via playstore on their gadgets and open it online at website <https://www.canva.com>. Figure 5 shows how a Canva page looks like:

**Figure 5. Canva initial screen display**

Like any other application products Canva has strengths and weaknesses. Among the strengths are:

It has a variety of interesting designs. It is potentially able to develop either teachers or students in designing instructional or learning media due to features-rich provided; It is efficient due to practicality in usage; It can be used on smartphones. Canva can be integrated to support learning. It can serve several purposes, such as; 1) to create concrete abstract ideas; 2) to motivate students; 3) to give direct attention; 4) to repeat information; 5) to recall previous knowledge; and 6) to make learning more effective [17].

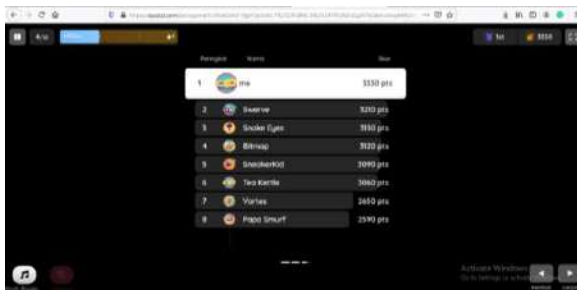
As an online based application, the gadget should be connected to the internet, which is one of Canva's weaknesses. Users always need to have internet connection. Beside a version with designs and templates that are available for free, this application product also offers paid version.

Here are the steps for using Canva:





Students can work on practice questions from the material that has been studied on laptops, smartphones or other electronic devices, they can compete in a healthy manner in doing quizzes with their friends because Quizziz is complete with a leaderboard to show the rankings of lively students. Then, teachers can view the history of the quiz process carried out by students and download it to measure student success [17].



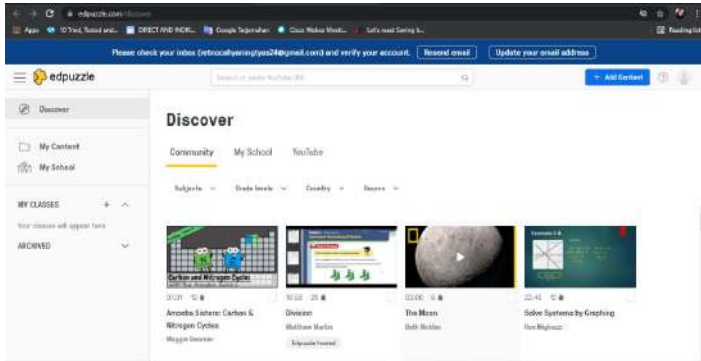
**Figure 7. Ranking system and audio features display**

Here are the steps for using Quizziz: Go to [www.quizziz.com](http://www.quizziz.com) and sign up.

You may sign-up to Quizziz via Facebook, Gmail, or registration by completing personal data to create a Quizziz account. Choose a role, whether as a teacher, student, parent or other. Complete the data. Fill in our quiz info. Complete modules such as questions, answer choices and correct answers. "Question preview" will display the questions that we created. Add a new question and click Finish when finished. The final stage, select the Grade, Subject. Click Finish or Create Quizz. Set your quizz, then click Proceed. Ask students to go to [join.quizziz.com](http://join.quizziz.com) and share the code with students. In addition, we can share it via Google Classroom.

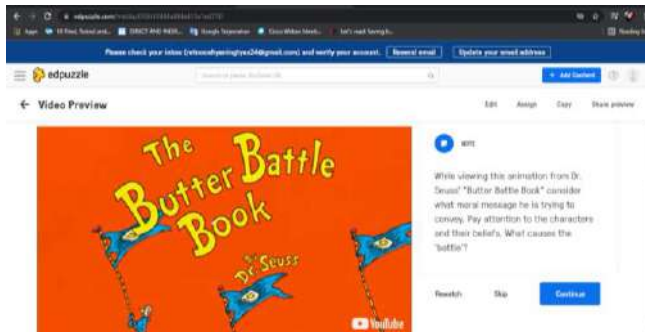
### Edpuzzle

Edpuzzle is a learning video maker tool that can be an alternative for teachers to make learning more interesting and interactive. This application is web-based which contains interesting videos that can be viewed by students. Here is the initial view of the Edpuzzle application:



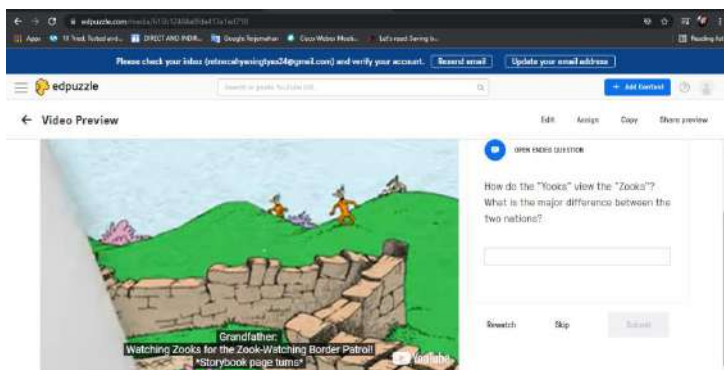
**Figure 8. Edpuzzle initial screen display**

Teachers can choose which topics are suitable for their students, or teachers can also upload their own videos from the file to be shared via Edpuzzle.



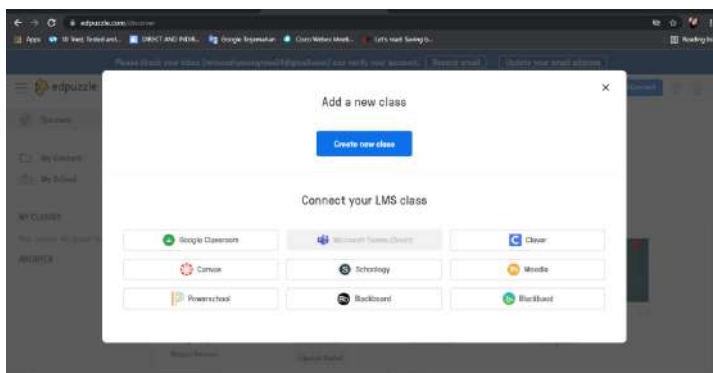
**Figure 9. Videos and questions side by side**

The video also provides subtitles in various languages, one of which is English (no Indonesian). At certain minutes, questions related to the video will appear. At the end of the video, questions will be asked too for a student evaluation.



**Figure 10. Videos available to enhance learning**

To invite students to the edpuzzle application, teachers can connect them to various educational LMS as seen in Figure 11



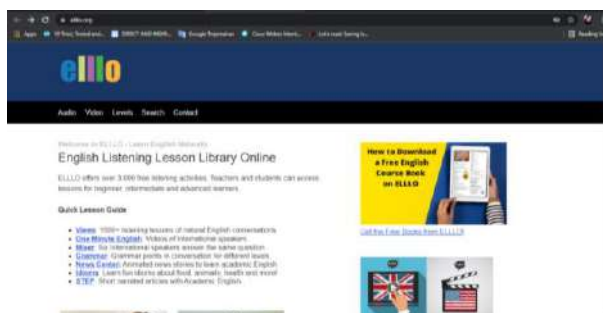
**Figure 11. Available options to connect to learning platforms**

Teachers can monitor student performance such as whether students watch videos, how many times students watch, and whether they understand the material given so that teachers can analyze with ease [20]. This is a very interesting application with interesting videos provided as well. This offers variety in learning where teachers can work without problems that often appear when using books or tape

recorders. However unfortunately, this application requires a stable internet connection. This is because no text script is provided to help students understand the story.

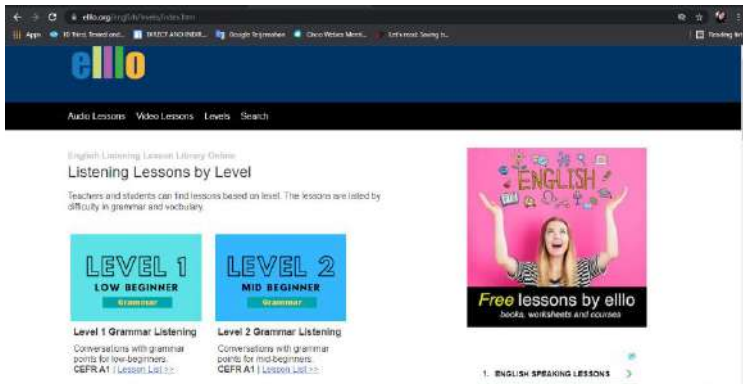
## Ello

Ello is a library for learning to listen to English online. Ello is a web-based application that has many features for learning to listen to English by watching videos, news, sports, and scenes. vocabulary test and listening comprehension test [21]. Therefore, it is highly recommended for use to develop students English listening skill. Here is the initial look of the Ello's website:



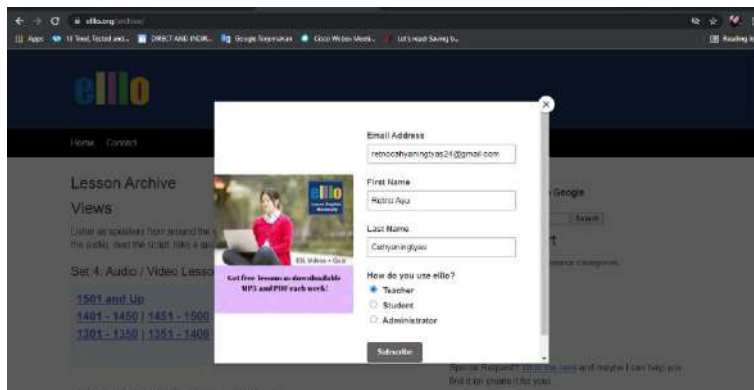
**Figure 12. Ello initial screen display**

This application offers various menus such as the “Audio” menu to listen to thousands of conversations. Not only that, Ello also provides scripts, grammar contained in conversations, and also quizzes to test students' understanding of conversations. Equally important, Ello provides a “Levels” feature where students can practice according to their abilities.



**Figure 13. Levels to select**

In addition, we can also register as shown in Figure 14:



**Figure 14. Registration-to-Ello screen display**

The following are the advantages of using Ello as a teaching medium:

It creates more fun learning because students can listen to the material through each student's smartphone.

It arises students' enthusiasm in listening.

It provides a wider coverage of learning resource.

It enables students to learn to listen more practically.

However, Ello also has limitations which, among others, are: Often within its system, videos cannot be played.

A comprehension test often presents repeated questions. In real life, repetition to be made is maximum twice.

Students can choose more than one option for an answer.

### **Innovations in English Language Teaching in Indonesia**

As stated earlier, the party that is most expected to take a better English teaching and learning in Indonesia is EFL educators. Their vital role as facilitator and strategic position closest to students (learners) should determine the color of English teaching and learning process as well as its outcome in Indonesia. A brief discussion of a variety of applications above has shown that the condition of English teaching and learning along with its outcome should be of great success with the most current technology available. Some studies, mostly experimental ones, show that English teaching benefit from such technologies [21]-[25]. In the context of learning, technology also assists English learning [26]. What about its reality outside the research context? The paragraphs that follow will criticize the real condition.

Before the pandemic stroke the world's inhabitants in early 2020, based on the author's observation and professional experience through trainings, technical coaching, and workshops given to EFL teachers throughout the Indonesian Archipelago, it can be said that overall the EFL teachers had used no technology as innovations in ELT. They tended to use handbook, handouts, and student worksheets available. During the pandemic, the teachers willy nilly have found it urgent to utilize communication technology. A few names popular to them are Whatsapps Group, Google Classroom, Edmodo, Zoom, Google Meet, Webex, Loom, Quizziz, and Duolingo [27]. Among those sorts of technology, surveys show diverse findings, though Whatsapps Group most frequently enters top three favorite platforms [28],[29].

So far, up to this article is written there has not been accurate and comprehensive data on, let us say, intensity of technology application as innovation in ELT in Indonesia. Amidst the pandemic a large number of studies have been conducted mostly in experimental mode. Majority are held to evaluate or assess impacts, such as responses, perceptions, learning outcome, or expectation while done in some qualitative or mixed method. It is very important to obtain the answer to question "How many English teachers do apply ELT technology in their classrooms?" An initial small scale survey is enough to start with. By doing so, despite the fact that other factors exist, it will make sense to assess and judge the achievement of EFL teaching and learning in Indonesia with regard to innovative practices of teaching English language.

## Conclusion

To sum up, technology in the area of ELT has advanced rapidly. It would have supported the English teaching and learning in Indonesia and taken it to a better achievement. Unfortunately, only after the pandemic stroke Indonesia in early 2020 then many teachers were forced to utilize a few sorts of communication technology as learning platforms. Some studies show the EFL teachers utilized the technology during the pandemic, but to what extent it is implemented in a larger scale remains unclear nevertheless. Therefore, studies on this topic are encouraged in order to see the existing condition of ELT innovations within this country.

## References

- [1] Malik, H., Humaira, M. A., Komari, A. N., Fathurrochman, I., & Jayanto, I. (2021). Identification of barriers and challenges to teaching English at an early age in Indonesia: An international publication analysis study. *Linguistics and Culture Review*, 5(1), 217-229.  
<https://doi.org/10.37028/lingcure.v5n1.1485>
- [2] Susanto, Malik A., & Mitrayati. (2020). The challenges of learning English as a foreign language among undergraduate students. *Inovish Journal*, 5(1), 1-11.
- [3] Songbatumis, A. M. (2017). Challenges in teaching English faced by English teachers at MTsN Taliwang, Indonesia, *Journal of Foreign Language Teaching and Learning*, 2(2), 54-67.
- [4] Renandya, W. A., Hamied, F. A., & Nurkamto, J. (2018). English language proficiency in Indonesia, *Journal of Asia TEFL*, 15(3), 618-629.
- [5] Suwartono, T. & Aniranti, A. (2019). Digital teaching tools in 21st century EFL classroom: Are our teachers ready? *ELLITE: Journal of English Language, Literatute, and Teaching*, 3(2), 57-62.
- [6] Ahmed, H. A. & Hasan, I. A. (2020). Foreign language autonomous learning: A theoretical account, *International Journal of Innovation, Creativity, and Change*, 12(4), 607-618.
- [7] Motteram, G. (2013). *Innovations in learning technologies for English language teaching*. London: British Council.
- [8] Budiman, M. A. (2012). Pemanfaatan teknologi informasi dan komunikasi dalam kelas bahasa Inggris, *Seminar Nasional Teknologi Informasi & Komunikasi Terapan 2012*, Semarang.



- [9] Dadan, Hamidah, E., Sofyan, I., et al. (2019). *Kelas digital: Technology enhanced language learning*. Bandung: Alfabeta.
- [10] An-Nisa, N., Astika, G. A., & Suwartono, T. (2021). Millenials, technology, and English language teaching. *Tarling: Journal of Language Education*, 5(1), 15-28.
- [11] Sreenathachary, V. (2011). Using internet in improving one' English language skills: 50 informative, educative, & entertaining websites, *The Criterion: An International Journal in English*, 2(2), 1-9.
- [12] Suwartono, T. (2021). FbG as an around the clock support for an essay writing course amidst the pandemic. *Edulite: Journal of English Education, Literature, and Culture*, 6(2), 238-255.
- [13] Suwartono, T. & Oktavia, N. F. (2019). In search of creative EFL teachers: A perspective from the best classroom practices. *ADJES*, 6(1), 9-19.
- [14] Sadiku, L. M. (2015). The Importance of four skills reading, speaking, writing, listening in a lesson hour. *European Journal of Language and Literature*, 1(1), 29-31.
- [15] Abramova, V. S & Boulahnane, S. (2019). Exploring the potential of online English websites in teaching English to non-linguistic major students: Breaking News English as example. *Register Journal*, 12(1), 1-12. <http://dx.doi.org/10.18326/rgt.v12i1.1-12>
- [16] Christiana, E. & Anwar, K. (2021). The Perception of using technology Canva application as a media for English teacher creating media virtual teaching and English learning in Loei Thailand. *Journal of English Teaching, Literature, and Applied Linguistics*, 5(1), 62-49.
- [17] Smaldino, S. E. (2015). *Instructional technology and media for learning*. New York: Pearson.
- [18] Zhao, F. (2019). Using quizizz to integrate fun multiplayer activity in the accounting classroom. *International Journal of Higher Education*, 8(1), 37-43. <https://doi.org/10.5430/ijhe.v8n1p37>
- [19] Namara, D. M., & Murphy, L. (2017). Online versus offline perspectives on gamified learning. *CEUR Workshop Proceedings*, 1857, 47-52.
- [20] Amaliah. (2020). Implementation of Edpuzzle to improve students' analytical thiking skill in narrative text. *Jurnal Ilmu Bahasa dan Sastra Program Studi Sastra Inggris Universitas Trunajaya (Prosodi)*, 14(1), 35-44.
- [21] Hadi, M. S., Izzah, L., & Fudiantari, S. M. (2021). The use of Ello in improving teaching listening to students. *Ethical Lingua*, 8(1).

DOI: 10.30605/25409190.256

- [22] Fadhilawati, A. (2021). Using Quizziz application for learning and evaluating grammar material, *JOSAR*, 6(1), 85-94.
- [23] Dewi, K. S., Myartawan, I. P. N. W., Swari, N. K. T. A., & Sugihartini, N. (2020). Quizziz effect on students' grammar mastery in higher EFL classroom based mobile assisted language learning (MALL), *LEJU*, 3(1), 15-24.
- [24] Harjanto, I. (2021). The preference for English in digital media among Indonesian millennials, *Beyond Words*, 9(1), 16-36.
- [25] Yundayani, Susilawati, Chairunnisa, (2019). Investigating the effect of Canva on students' writing skill, *English Review: Journal of Education*, 7(2), 169-176.
- [26] Kieu, V. L., Anh, D. T., Tran, P. D. B., Nga, T. N., & Ho, P. V. P. (2021). The effectiveness of using technology in learning English. *AsiaCALL Online Journal*, 12(2), 24-40.
- [27] Wilson, A. (2020). Penerapan metode pembelajaran daring (online) melalui aplikasi berbasis android saat pandemi global, *SAP (Susunan Artikel Pendidikan)*, 5(1), 66-72.
- [28] Hakim, L. (2020). Pemilihan *platform* media pembelajaran online pada masa *new normal*, *Justek: Jurnal Sains dan Teknologi*, 3(2), 27-36.
- [29] Rahman, B. I. & Daulay, E. (2021). Online learning media: English Education Department students' perspective, *Metathesis: Journal of English Language Literature and Teaching*, 5(1), 50-64.

# Blended Learning Strategy During the COVID-19 Pandemic in Plant Tissue Culture Course

Trianik Widyaningrum<sup>115</sup>

## Introduction

Plant tissue culture is branch of biological science that study about cell theory of totipotency, it's benefits, needs and implementation, science the underlying plant tissue culture, aseptic techniques, Plant tissue cultures medium and it's components [1] According to Batubara [2], students have difficulties in learning plant tissue culture course in university due to lack of learning aid in understanding the course optimally. Blended learning has the capability to improve science process skills and the learning achievement of students in plant tissue culture course. This is because it provides a lot of learning aids like: images, animations, videos, texts, pictures, chat room, etc. In addition, it creates an interaction among students. Finally, it supports constructive and the social learning experiences of students. It also has a wide scope for extending immense opportunity for students to ask questions, describe objects and events, acquire knowledge, construct explanations of natural phenomena, test those explanations in many different ways and communicate their ideas to others [3].

The rapid development of technology, communication, and information, especially the internet has become a demand for lectures in Indonesia to be able to use it as a source of positive learning media in supporting the teaching and learning process. The use of media technology provides benefits for lectures and students to access the materials and interact in faceto-face conventional learning, and also outside the classroom through an online platform [4]. One of the positive values of Internet technology, for example, enables learners to discuss and collaborate to solve problems both in class and outside of class [5].

Asfar and Zainuddin [6] revealed that the use of media technology in the 21st century has become a demand and necessity for every lecture to encourage students to study independently, collaboratively, creatively and critically in solving problems. In

---

<sup>115</sup> Ahmad Dahlan University

addition, the media technology also allows students and lecturers to easily access the learning materials anytime and anywhere through various sites provided free by several institutions in the world. The various learning resources are currently provided by many World institutions through their website and can be used as a source and medium for active and interactive learning.

The common implementation of Internet in teaching and learning environment is known as e-learning. While e-learning involves the use of Internet technologies to enhance knowledge and performance [7]. Blended learning aims at combining the advantages of both face-to-face and e-learning environments [8]. Hopper [9] stated that blended courses have proven to be more effective than fully online courses because blended learning can create a positive relationship between face-to-face and online environments. Blended learning develops students as independent learners [10].

A typical example of blended learning methodology is the combination of technologybased materials and face-to-face sessions in presenting content [11]. So, blended learning offers students the flexibility of place, time, media, and pace to learn without ignoring the social needs for student to collaborates, interacts, engage in critical debates, and communicate with other students and lecturers.

## **Discussion**

Blended learning provides students access to multiple media and learning aids under the guidance and the control of lecturers. It also offers a flexible learning time for students in some subject. As a result, the students can manage their own learning time based on their availability and learning styles. The forum and discussion room in learning website provide students places to ask questions and provide answers, engage in critical debate, and discuss the learning material [1]

Various literatures report that utilization of information and communication technologies (ICT) can bring beneficial effect in improving teaching and learning process [12]–[17]. For instance, Tshabalala et al, [18] examine the blended learning perceptions of faculty members and identified different challenges experiencing on the use of blended- based approach. Findings showed that some respondents perceived that blended-based instruction has the potential to bring teaching and learning flexibility and promotes learning independence and opportunities for networked learning and accessibility to both lecturers and students. However, they also

demonstrated little or lack of understanding to blended learning concepts. Respondents also perceived blended learning as difficult to execute in classroom environment due to the absence of institutional policies on the use of blended learning, lack of ICT training/knowledge (e.g., technophobia), poor confidence to engage in blended learning approach, and limited access to computer laboratories. Hence, these were perceived to be hindrances in the implementation of blended learning

Computer, internet and its associated technologies are considered as the main ICTs and basics to rest of such technologies. Seemingly, ICTs have become popular and are used to facilitate and enhance communication and interactions among the users [19]. Blended learning forces us to consider the characteristics of digital technology, in general, and information communication technologies (ICTs), more specifically [20]. Aspects of blended e-learning such as: web-based instruction, streaming video, audio, synchronous and asynchronous communication, etc: with traditional, face-to-face”learning [12].

### **Benefits of blended learning**

A study conducted in Saudi revealed that majority of the faculty members have understood their roles in blended-based environment. It was found out that blended learning mitigates the delivery of teaching and learning access regardless of time and space [21]. Findings revealed a positive perception of academic staff towards the affordability that blended learning can bring in teaching and learning context. It emphasizes the view of blended learning as it delivers access to course materials regardless of time and space. It indicates significant valuation of personal space and convenience in accessing learning resources. Relating the abovementioned report of [21], it claims that ICT is not confined to its functions of delivering high quality data, but it also offers a platform for using variety of instructional tools that is significant for distance learning, such as in the case of blended- based approach [22]–[24]. This also explains that the capability of blended-based instruction to access wide array of course materials contributes to increase learners’ rates of information retention [25].

Moreover, the use of blended-based instruction allows more engagement, and it increases students’ participation [26]–[29]. In a case study presented by Benson, Anderson, & Ooms [30], it was revealed that majority of the participants had reported an

appreciation to the utilization of ICT-based instruction using blended learning approach. Arguably, despite some degree of concerns on the use of web-based instruction, such as timeconsuming, morerigorous in teaching-learning preparations, and not all faculty members are inclined towards blended-based instruction, most of the academic staff have acknowledged its positive benefits in integrating with physical teaching approach. Gedik, Kiraz, & Ozden [31] discuss that the use of blended-based instruction allows more engagement, and it increases students' participation. Relating this to the study conducted by Benson et al. [30], it suggests effectiveness using a combination of face-to-face and online teaching approach. As such, it provides sense of flexibility for better classroom participation.

### **Challenges of blended learning**

In terms of the challenges on the use of blended learning [32]–[36], studies have shown that not all faculty members are inclined towards blended-based instruction [30]. Some still considered the use of ICT as “time-consuming” [30]. For example, it was revealed that preparations for lecture or teaching materials design and development on web- based platform require more time than face-to-face interaction. Some believe that the use of hybrid approach is more rigorous when it comes to teaching and learning preparations. This explains the idea presented by [37] where they described blended learning as a burden, both physically and cognitively. Meaning, educators see the need to spend more time like designing the course platform, uploading of instructional materials, answering queries and evaluating students' online outputs. Thus, it increases their workload, such as the time required [38].

This posits that in blended learning environment, lectures should have at least the required knowledge and skills to mix the right blending in teaching and learning process. As such, the use of technology tools should best meet the needs of the learners while ensuring the appropriateness of right blended learning nature of the course e.g [39]–[42]. Santally, Lee, Lim, & Kim, [42]. However, these lack of technological capabilities of some faculty members (e.g., [27], [37], [43]) affect students' way of discovering learning. Hence, it also results to some academicians having adverse attitude towards blended-based approach.

For Aldosemani et al. [21], the lack of faculty training and support, language barriers, poor promotionincentives for blended learning initiation are some of the challenges that lecturer are

experiencing on the use of blended learning. It was mentioned, for instance, that the use of language texts in LMS in Saudi context is presented using English language, thus, the faculty members are having difficulty to academically communicate with their students and colleagues, considering English language is not their primary or secondary language. It was also revealed that technological infrastructures, such as lack of computers, internet connection, and LMS instability, prohibit blended learning in the country.

## **Conclusion**

Blended learning is a learning method that supports the use of technology in face-to-face conventional learning. Blended learning provides students access to multiple media and learning aids under the guidance and the control of lecturers. Various strategies can be used in applying this blended learning.

## **References**

- [1] F. Harahap, N. E. A. Nasution, and B. Manurung, "The effect of blended learning on student's learning achievement and science process skills in plant tissue culture course," *Int. J. Instr.*, vol. 12, no. 1, pp. 521–538, 2019.
- [2] M. S. Batubara, "Development of Problem Based Network Culture Course Learning Videos," UNIMED, 2016. D. Krishnan, "Effect of Blended Learning Strategy on Learning Science among Secondary School Students," Cinnamonteal Publishing, 2015.
- [3] C. H. Hwang, G. J., & Chen, "). Influences of an inquiry based ubiquitous gaming design on students' learning achievements, motivation, behavioral patterns, and tendency towards critical thinking and problemsolving," *Br. J. Educ. Technol.*, vol. 48, no. 4, pp. 950–971, 2017.
- [4] Z. Halili, S. H., & Zainuddin, "Flipping the Classroom: What we know and what we don't," *Online J. Distance Educ. e Learn.*, vol. 3, no. 1, pp. 28–35, 2015.
- [5] Z. Asfar, N., & Zainuddin, "Secondary students' perceptions of information, communication, and technology (ICT) use in promoting self-directed learning in Malaysia," *Online J. Distance Educ. E-Learning*, vol. 3, no. 4, pp. 67–82, 2015.
- [6] A. K. Jethro, O. O., Grace, A. M., Thomas, "E-Learning and its effects on teaching and learning in a global age," *Int. J. Acad. Res. Bus. Soc. Sci.*, vol. 2, pp. 203–210, 2012.

- [7] S. Ghahari, "The Effect of Blended Learning vs. Classroom Learning Techniques on
- [8] Iranian EFL Learners' Writing," *Int. J. Foreign Lang. Teach. Res.*, vol. 1, no. 3, 2013. [9] K. Hopper, "Reasons to go hybrid," *Distance Educ. Rep.*, vol. 7, no. 24, p. 7, 2003.
- [9] N. S. Snodin, "The Effects of blended Learning with a CMS on the Development of Autonomous Learning: A Case Study of Different Degrees of Autonomy Achieved by Individual Learners," *Comput. Educ.*, vol. 61, pp. 209–216, 2013.
- [10] Coswie P. & M. Nichols, "The clash of cultures: Hybrid learning course development as management of tension," *J. Distance Educ.*, vol. 24, no. 1, pp. 77–90, 2010.
- [11] M. Ahmed, G., Arshad, M., & Tayyab, "Study of effects of ICT on professional development of teachers at university level. European," *J. Nat. Soc. Sci.*, vol. 8, no. 2, pp. 162–170, 2019.
- [12] A. M. Bas, G., Kubiato, M., & Sünbül, "Teachers perceptions towards ICTs in teachinglearning process: Scale validity and reliability study," *Comput. Human Behav.*, vol. 61, pp. 176–185, 2016.
- [13] O. Bond, M., Marín, V. I., Dolch, C., Bedenlier, S., & Zawacki-Richter, "Digital transformation in German higher education: student and teacher perceptions and usage of digital media," *Int. J. Educ. Technol. High. Educ.*, vol. 15, no. 1, 2018.
- [14] M. A. Shamim, M. R. H., & Raihan, "Effectiveness of using ICTs to promote teaching and learning in technical education: Case of Bangladesh," *Int. J. Vocat. Tech. Educ.*, vol. 8, no. 2, pp. 12–19, 2016.
- [15] L. Tømte, C. E., Fossland, T., Aamodt, P. O., & Degn, "Digitalisation in higher education: Mapping institutional approaches for teaching and learning," *Qual. High. Educ.*, vol. 15, no. 1, pp. 98–114, 2019.
- [16] T. Willis, R. L., Lynch, D., Fradale, P., & Yeigh, "Influences on purposeful implementation of ICT into the classroom: An exploratory study of K-12 teachers," *Educ. Inf. Technol.*, vol. 24, no. 1, pp. 63–77, 2018.
- [17] T. Tshabalala, M., Ndeya-Ndereya, C., & van der Merwe, "Implementing blended learning at a developing university: Obstacles in the way," *Electron. J. E-learning*, vol.12, no. 1, pp. 101–110, 2014.
- [18] S. S. Dhiman, A. David, V. W. Braband, A. Hussein, D. R. Salem, and R. K. Sani, "Improved bioethanol production from corn



- stover: Role of enzymes, inducers and simultaneous product recovery," *Appl. Energy*, vol. 208, 2017.
- [19] N. Dziuban, C., Graham, C. R., Moskal, P. D., Norberg, A., & Sicilia, "Blended Learning: The New Normal And Emerging Technologies," *Int. J. Educ. Technol. High. Educ.*, vol. 15, no. 3, pp. 1-16, 2018.
- [20] D. U. Aldosemani, T., Shepherd, C. E., & Bolliger, "Perceptions of instructors teaching in Saudi blended learning environments," *TechTrends*, vol. 63, no. 3, pp. 341-352, 2018.
- [21] J. H. Rivera, "The blended learning environment: A viable alternative for special needs students," *J. Educ. Train. Stud.*, vol. 5, no. 2, pp. 79-84, 2017.
- [22] J. Smith, K., & Hill, "Defining the nature of blended learning through its depiction in current research.," *High. Educ. Res. Dev.*, vol. 38, no. 2, pp. 383-397, 2018.
- [23] D. Vaughan, N., Reali, A., Stenbom, S., Van Vuuren, M. J., & MacDonald, "Blended learning from design to evaluation: International case studies of evidence-based practice," *Online Learn.*, vol. 21, no. 3, pp. 103-114, 2017.
- [24] X. Wang, M., Shen, R., Novak, D., & Pan, "The impact of mobile learning on students' learning behaviours and performance: Report from a large blended classroom," *Br. J. Educ. Technol.*, vol. 40, no. 4, pp. 673-695, 2009.
- [25] H. Baragash, R. S., & Al-Samarraie, "Blended learning: Investigating the influence of engagement in multiple learning delivery modes on students' performance," *Telemat. Informatics*, vol. 35, no. 7, pp. 2082-2098, 2018.
- [26] L. Bowyer, J., & Chambers, "Evaluating blended learning: Bringing the elements together," *Res. Matters A Cambridge Assess. Publ.*, vol. 23, pp. 17-26, 2017.
- [27] M. Morton, C. E., Saleh, S. N., Smith, S. F., Hemani, A., Ameen, A., Bennie, T. D., & Toro-Troconis, "Blended learning: How can we optimise undergraduate student engagement," *BMC Med. Educ.*, vol. 16, no. 1, p. 195, 2016.
- [28] I. Palmer, E., Lomer, S., & Bashliyska, "Overcoming barriers to student engagement with active blended learning: Interim report," *Northampton Univ. Northampton*, 2017.
- [29] A. Benson, V., Anderson, D., & Ooms, "Educators' perceptions, attitudes and practices: Blended learning in business and management education," *Res. Learn. Technol.*, vol. 19, no. 2, pp. 143-154, 2011.

- [30] Y. Gedik, N., Kiraz, E. & Ozden, "Design of a blended learning environment: Considerations and implementation issues," *Australas. J. Educ. Technol.*, vol. 29, no.1, pp. 1–19, 2013.
- [31] K. K. Albiladi, W. S., & Alshareef, "Blended learning in English teaching and learning: A review of the current literature," *J. Lang. Teach. Res.*, vol. 10, no. 2, pp.232–238, 2019.
- [32] M. B. Bataineh, R. F., & Mayyas, "The utility of blended learning in EFL reading and grammar: A case for Moodle," *Teach. English with Technol.*, vol. 17, no. 3, pp. 35–49,2017.
- [33] L. Crawford, R., & Jenkins, "Blended learning and team teaching: Adapting pedagogy in response to the changing digital tertiary environment," *Australas. J. Educ. Technol.*, vol. 33, no. 2, 2017.
- [34] L. C. Medina, "Blended learning: Deficits and prospects in higher education," *Australas. J. Educ. Technol.*, vol. 34, no. 1, 2018.
- [35] S. G. Shand, K., & Farrelly, "The art of blending: Benefits and challenges of a blended course for preservice teachers," *J. Educ. Online*, vol. 15, no. 1, 2018.
- [36] M. A. Ma'arop, A. H., & Embi, "Implementation of blended learning in higher learning institutions: A review of the literature," *Int. Educ. Stud.*, vol. 9, no. 3, pp. 41–52, 2016.
- [37] S. Alebaikan, R., & Troudi, "Blended learning in Saudi universities: Challenges and Perspectives," *ALT-J*, vol. 18, no. 1, pp. 49–59, 2010.
- [38] B. Bralić, A., & Divjak, "Use of MOOCs in traditional classroom: Blended learning approach," *Eur. J. Open, Distance E-learning*, vol. 21, no. 1, 2018.
- [39] Z. Chaeruman, U. A., Wibawa, B., & Syahrial, "Determining the appropriate blend of blended learning: A formative research in the context of spada-Indonesia," *Am. J. Educ. Res.*, vol. 6, no. 3, pp. 188–195, 2018. [41] R. Greller, W., Santally, M. I., Boojhawon, R., Rajabalee, Y., & Kevin, "Using learning analytics to investigate student performance in blended learning courses," *J. High. Educ. Dev.* 12(1), 37-6, vol. 12, no. 1, pp. 37–63, 2017.
- [40] H. Lee, J., Lim, C., & Kim, "Development of an instructional design model for flipped learning in higher education," *Educ. Technol. Res. Dev.*, vol. 65, no. 2, pp. 427–453,2017.
- [41] V. Krasnova, L., & Shurygin, "Blended learning of physics in the context of the professional development of teachers," *Int. J. Emerg. Technol. Learn.*, vol. 14, no. 23, pp. 17–32, 2019.

## **The Approach to Stunting Problems in the Society 5.0 Era**

Wa Ode Salma<sup>116</sup>

### **Introduction**

The impact of COVID-19 has led to an estimation of more than 2 million children being at a high risk of experiencing growth retardation or stunting due to malnutrition [1], [2]. Stunting is one of the most complex public health problems whose mechanism is not clearly understood. Stunted children have a fairly high risk of death, as about 14% of childhood deaths are due to this cause [3]. The experience also leads to a decrease in motor and cognitive function, behavioral disorders, impaired immunity [4], [5] shorter physical posture [6]. Low performance in school, reduced physical work capacity, low wages in adulthood, increased risk of high cardiovascular disease [6], [7]. 54 % of adolescents had stunted posture and 49% were thin as a result of their socioeconomic status and lack of proper awareness. Additionally, the prevalence of stunting was significantly higher in girls with 58.4% than boys with 48.7% [8].

The rate of stunting in children can be reduced in a variety of ways, such as through the collaborative efforts between the private and public sectors in improving nutritional programs. To achieve this, need to promotes healthy food choices, and ensures the access of nutritious food to the poor [9]. The South Asia has one of the highest rates of stunting prevalence in the world, with about 61% in 1990, dropping to 34% in 2018. In addition. Improving nutrition is therefore very important for the reduction of stunting rates, as statistical data in the country showed that reduction in poverty rates leads to increased access to health care, education, and sanitation services [10]. The prevalence of stunting in China decreased by 58.7%, but despite this improvement, it remains on the high side, at a rate of 11.6%. In other to curb this issue, addressing the nutritional demands of pregnant women, breastfeeding mothers, and children's growth, as well as challenges and policy measures, are to be sought, including efforts to improve exclusive breastfeeding in newborns [11].

Currently, Indonesia is struggling with the challenge of malnutrition in children. In this situation, the basic health research data of Indonesia in 2018 showed that 17.7% of children were

---

<sup>116</sup> Halu Oleo University, Kendari

malnourished with a high prevalence of stunting at 37%. The existence of technological advancements and the availability of smartphones with their various mobile applications (the era of the industrial revolution 4.0) has, in turn, led to the provision of great opportunities for artificial intelligence to enable efficient delivery of healthcare services, including the approach to stunting problems in society 5.0 through digital innovation with Artificial Intelligence (AI), the Internet of Things (IoT), and other digital technologies and data. It is important to learn how to support the government in detecting, preventing, and accelerating the decline in stunting through the use of digital technology in the Society 5.0 era, by promoting young women, women planning to get married, pregnant women, breastfeeding mothers, and children, to experience public or private health screening.

The development of these technologies has increasingly supported the improvement of services in the health sector, making it easier for humans to obtain necessary information, leading to an improved quality of healthcare services [12]–[14]. Conversely, Society 5.0, known as the super-smart society, is the last bridge between machines and humans. Among these new technologies, the most important are AI, and digital platforms. The current generation is also preparing for a more personalized future due to the recent development and adoption of AI algorithms. In addition, national policies and private sector involvement showed promise in the development of Artificial Intelligence applications and workforce efficiency in healthcare [13], [15]. This research, therefore, aims to provide an overview of the types of applications and their uses in the prevention and control of stunting, based on digital technology from various sources of scientific information. The importance lies in the fact that the use of digital technology in addressing stunting issues in Indonesia is relatively restricted, particularly among mothers and adolescent girls.

## **Discussion**

The international attention to low and middle-income countries concerning stunting approaches has also shown short and long-term health consequences [16], [17]. Subsequently, government support is contained in the Indonesian Presidential Regulation, number 72 of 2021 concerning the hastened reduction in stunting rates. The use of artificial intelligence applications, showed significant promise for the improvement of the productivity and efficiency of

healthcare services with the use of limited resources [18], [19]. Several results of previous research showed variations in applications developed specifically in Middle-low income countries, including mHealth, Saathealth, Kilkari, GiAS, NUTRIMO, M-SAKHI, ACALS, PROSA-HI, and the Near Real-time Monitoring System. Furthermore, these applications were developed to increase the scope of stunting control targeted towards stunting children and their parents, the health of pregnant women, children, and adolescents.

### **Mobile Message Alert System Approach to Mothers**

In Indonesia, the impact of the COVID-19 pandemic, was known to affect the handling of maternal referral services in obtaining blood-enhancing tablets. Therefore, the Cegah Anak Lahir Stunting (ACALS) application was developed to help to make government programs successful by increasing the compliance of pregnant women in consuming blood-enhancing tablets [20]. Moreover, Kilkari Application is one of the largest mobile application programs in the world for mothers, and is available to subscribers for free. This technology benefits its subscribers as they receive up to 90 minutes of content via 72 every week calls from the fourth month of pregnancy until the child is 1 year old. Although this application has been shown to improve mother and children's health, it is limited in the poorest and most marginalized communities due to a lack of phones or women with no access to phones or are not registered in the tracking database [21], [22].

The expansion of mobile internet reach to low-income populations has offered exciting opportunities to access, educate, and generate demand from healthcare users. This can be seen from the use of medical device applications (mHealth) and other mobile applications like Saathealth have been developed in India, which shows an effective value for reducing health care costs by providing greater knowledge about diseases, improving quality of life-related to maternal and children health, and self-management strategies by making its users informed and actively involved in managing their health [23]. This has led to women exposed to the mHealth message making significant improvements in primary infant care practices and supplementary solid feeding at 6 months of age, which potentially enhanced infant growth and development [24].

Currently, the use of mobile health for early detection and prevention of stunting in Indonesia is still limited. In response to these challenges, Sunarsih and members of the research team developed an

application called Children's Companion Program-Holistic Integrative (Prosa-Hi). This program can detect children's growth and development comprehensively in the current month [25]. Similarly, another application developed by Permana and colleagues in Indonesia is the card towards health (KMS) has also been modeled into an application called NUTRIMO (Nutrition Monitoring), which also has several other features, such as informing parents about nutritional recommendations based on their nutritional status [26]. Interestingly, to digitally document the nutritional intake of children, the development of the GiAS application was introduced. This application is used to record the amount of food intake through food recall thereby making nutrients absorbed by the body known. This application also displays a menu of recommendations that can help mothers or parents of stunted and non-stunted children prepare food menus enabling users of this application to prepare food according to the nutritional needs of their children [27].

In 2015, Zimbabwe adopted a Food and Nutrition Policy that uses a multi-sectoral approach to stunting alleviation and establishes a coordination mechanism from the National level to the community (village) level in the form of Food Security and Nutrition. On this basis, Gomora and colleagues carried out an application development study called near-real-time monitoring (NRTM), which is an application for a community-based multi-sectoral model as an effort to reduce stunting. The results of the NRTM implementation showed that there was an increase in the coordination of the Multisectoral Community Based Model (MCBM) for stunting reduction due to increased monitoring and feedback through NRTM as well as citizen involvement [28]. The introduction of the M-SAKHI application in Mobile phones may enable health care practitioners to monitor patient health in real-time, to improve health and nutrition behavior [29].

### **The Support of Innovative Technology Integration in Adolescent Nutrition Learning**

Learning approaches through the integration of innovative technologies are essential to support the improvement of adolescent health and nutrition [30]–[32]. Increased linear growth during adolescence can hence provide children a second chance to recover from stunted growth caused by malnutrition and micronutrient deficiencies throughout childhood. Therefore, Improving adolescent diet and food quality will assist to reduce anemia and micronutrient

deficiencies, as well as boost physical and cognitive growth [33], [34], enabling girls to reach pregnancy in a healthier state, resulting in better maternal health and delivery outcomes [34], [35].

The emergence of mobile health applications and their known effectiveness in improving healthy behaviors, the mHealth intervention in the form of the Foodbot Factory application was developed by an interdisciplinary team of experts in the fields of nutrition and education (pedagogy), design and educational technology at Ontario Tech University in Oshawa, Canada. This application served both as very interesting and educational for Canadians. Children aged 9-12 also find the Foodbot Factory application fun and easy to use. The application has shown in facilitating learning and effective to support children's knowledge of nutrition [36], [37]. The Japanese Asken Diet application is a similar one that can motivate its users by sharing their eating habits. Visualization of eating habits in this method, can make users aware and lead to an improvement [38]. The mHealth intervention is also an innovative way to facilitate nutritional education for the support of linear growth of children and adolescents as they increasingly have access to mobile devices both at home and school.

## **Conclusion**

The contribution of digital technologies to sustainable development goals is an important policy issue for Society 5.0. Providing better children's healthcare is the human right of every child around the world, therefore, the Society 5.0 era's response to stunting problems is an opportunity to develop current solutions that will help to expedite stunting reduction.

## **Reference**

- [1] M. Kabir, M. A. N. Saqib, M. Zaid, H. Ahmed, and M. S. Afzal, "COVID-19, economic impact and child mortality: A global concern," *Clinical Nutrition (Edinburgh, Scotland)*, vol. 39, no. 7, p. 2322, 2020.
- [2] Unicef, "Tracking the situation of children during COVID-19," *Mei 2021*, 2021. <https://data.unicef.org/resources/rapid-situation-tracking-covid-19-socioeconomic-impacts-data-viz/>.
- [3] A. . Weise, "WHA global nutrition targets 2025: stunting policy brief," *who.int*, 2012. .

- [4] W. O. Salma, *Buku Ajar Berbasis Ilmiah "Pangan Hayati Laut "Aplikasi kualitas gizi biota laut terhadap imunitas tubuh dan produktivitas."* Yogyakarta.: Penerbit Deepublish, 2020.
- [5] W. O, Salma, Yasir Haya, L.O, Christian Binékada, Adriyan Fristiohady, Alifariki, *Potret Masyarakat Pesisir; Konsep Inovasi Gizi & Kesehatan.* Yogyakarta: Penerbit Deepublish, 2021.
- [6] L. O. Alifariki, *Gizi Anak dan Stunting.* Yogyakarta: Penerbit LeutikaPrio, 2020.
- [7] S. B. Geberselassie, S. M. Abebe, Y. A. Melsew, S. M. Mutuku, and M. M. Wassie, "Prevalence of stunting and its associated factors among children 6-59 months of age in Libo-Kemekem district, Northwest Ethiopia; A community based cross sectional study," *PLoS one*, vol. 13, no. 5, p. e0195361, 2018.
- [8] A. Pal, A. K. Pari, A. Sinha, and P. C. Dhara, "Prevalence of undernutrition and associated factors: A cross-sectional study among rural adolescents in West Bengal, India," *International Journal of Pediatrics and Adolescent Medicine*, vol. 4, no. 1, pp. 9-18, 2017.
- [9] Z. A. Bhutta *et al.*, "How countries can reduce child stunting at scale: lessons from exemplar countries," *The American journal of clinical nutrition*, vol. 112, no. Supplement\_2, pp. 894S-904S, 2020.
- [10] K. Conway *et al.*, "Drivers of stunting reduction in Nepal: a country case study," *The American journal of clinical nutrition*, vol. 112, no. Supplement\_2, pp. 844S-859S, 2020.
- [11] B. Yang *et al.*, "Child nutrition trends over the past two decades and challenges for achieving nutrition SDGs and national targets in China," *International journal of environmental research and public health*, vol. 17, no. 4, p. 1129, 2020.
- [12] A. Gubawa, T. Abuzairi, and A. Henri, "Electronic system design for clinical applications of stunting case Electronic System Design for Clinical Applications of Stunting Case," vol. 050004, no. March, 2021.
- [13] Z. Sarfraz, A. Sarfraz, H. M. Iftikar, and R. Akhund, "Is covid-19 pushing us to the fifth industrial revolution (Society 5.0)?," *Pakistan journal of medical sciences*, vol. 37, no. 2, p. 591, 2021.
- [14] Y. Y. M. Aung, D. Wong, and D. S. W. Ting, "The promise of artificial intelligence: a review of the opportunities and challenges of artificial intelligence in healthcare," *British medical bulletin*, 2021.



- [15] E. Ishii, D. K. Ebner, S. Kimura, L. Agha-Mir-Salim, R. Uchimido, and L. A. Celi, "The advent of medical artificial intelligence: lessons from the Japanese approach," *Journal of Intensive Care*, vol. 8, pp. 1–6, 2020.
- [16] M. De Onis and F. Branca, "Childhood stunting: a global perspective," *Maternal & child nutrition*, vol. 12, pp. 12–26, 2016.
- [17] C. Urgell-Lahuerta, E. Carrillo-Álvarez, and B. Salinas-Roca, "Interventions on Food Security and Water Uses for Improving Nutritional Status of Pregnant Women and Children Younger Than Five Years in Low-Middle Income Countries: A Systematic Review," *International Journal of Environmental Research and Public Health*, vol. 18, no. 9, p. 4799, 2021.
- [18] A. Ganju, S. Satyan, V. Tanna, and S. R. Menezes, "AI for Improving Children's Health: A Community Case Study," *Frontiers in Artificial Intelligence*, vol. 3, p. 99, 2021.
- [19] S. P. Rowland, J. E. Fitzgerald, T. Holme, J. Powell, and A. McGregor, "What is the clinical value of mHealth for patients?," *NPJ digital medicine*, vol. 3, no. 1, pp. 1–6, 2020.
- [20] E. Rianti, A. Triwinarto, and E. Lukman, "APLIKASI CEGAH ANAK LAHIR STUNTING BERBASIS," *Prosiding Forum Ilmiah Tahunan IAKMI (Ikatan Ahli Kesehatan Masyarakat Indonesia)*, pp. 25–26, 2020.
- [21] D. Mohan *et al.*, "Can health information through mobile phones close the divide in health behaviours among the marginalised? An equity analysis of Kilkari in Madhya Pradesh, India," *BMJ Global Health*, vol. 6, no. Suppl 5, p. e005512, 2021.
- [22] A. J. D. Barros *et al.*, "Equity in maternal, newborn, and child health interventions in Countdown to 2015: a retrospective review of survey data from 54 countries," *The Lancet*, vol. 379, no. 9822, pp. 1225–1233, 2012.
- [23] B. Wahl, A. Cossy-Gantner, S. Germann, and N. R. Schwalbe, "Artificial intelligence (AI) and global health: how can AI contribute to health in resource-poor settings?," *BMJ global health*, vol. 3, no. 4, p. e000798, 2018.
- [24] N. Murthy *et al.*, "The Impact of an mHealth voice message service (mMitra) on infant care knowledge, and practices among low-income women in india: findings from a pseudo-randomized controlled trial," *Maternal and child health journal*, vol. 23, no. 12, pp. 1658–1669, 2019.
- [25] T. Sunarsih and A. I. Wicaksono, "Children ' s Companion Program-Holistic Integrative ( Prosa Hi ) – Smart E-Health To

- Monitoring Children ' s Growth And Development," vol. 07, no. 07, pp. 276–285, 2020.
- [26] D. M. Azizah, E. O. Permatasari, and L. Fekri, "A Stunting Prevention Application ' Nutrimo ' ( Nutrition Monitoring )," *Journal of Physics: Conference Series*, 2021, doi: 10.1088/1742-6596/1844/1/012023.
- [27] F. P. Hidayat, R. Rowawi, H. Wijayanegara, H. Garna, and A. Rachmiatie, "Android-based Stunting Child Nutrition Application ( GiAS ) to Assess Macro-nutrients , Zinc , and Calcium in Stunting and Non-stunting Under Two Children Aplikasi Gizi Anak Stunting ( GiAS ) berbasis Android untuk Menilai Zat Gizi Makro , Zinc , dan Kals," *Global Medical and Health Communication*, vol. 9, no. 71, pp. 61–68, 2021.
- [28] Z. Gomora *et al.*, "Effective Use of Near Real-time Monitoring System for Stunting Reduction in Zimbabwe," vol. 7, pp. 89–100, 2019, doi: 10.17265/2328-7136/2019.02.004.
- [29] C. Lund, "Maternal depression," *Health And Education Advice & Resource Team*, pp. 1–7, 2016.
- [30] V. M. Oddo, A. Roshita, and J. H. Rah, "Potential interventions targeting adolescent nutrition in Indonesia: a literature review," *Public health nutrition*, vol. 22, no. 1, pp. 15–27, 2019.
- [31] L. Sancu, "The integration of innovative technologies to support improving adolescent and young adult health," *The Journal of Adolescent Health*, vol. 67, no. 2, p. S1, 2020.
- [32] C. E. Irwin, "Using Technology to improve the health and well-being of adolescents and young Adults," *Journal of Adolescent Health*, vol. 67, no. 2, pp. 147–148, 2020.
- [33] C. R. Canavan and W. W. Fawzi, "Addressing knowledge gaps in adolescent nutrition: toward advancing public health and sustainable development," *Current developments in nutrition*, vol. 3, no. 7, p. nzz062, 2019.
- [34] R. Sparrow *et al.*, "Adolescent Nutrition—Developing a Research Agenda for the Second Window of Opportunity in Indonesia," *Food and nutrition bulletin*, vol. 42, no. 1\_suppl, pp. S9–S20, 2021.
- [35] R. Charles Shapu, S. Ismail, N. Ahmad, L. P. Ying, and I. Abubakar Njodi, "Knowledge, attitude, and practice of adolescent girls towards reducing malnutrition in Maiduguri metropolitan council, Borno State, Nigeria: cross-sectional study," *Nutrients*, vol. 12, no. 6, p. 1681, 2020.

- [36] J. M. Brown *et al.*, "Optimizing child nutrition education with the Foodbot Factory mobile health app: formative evaluation and analysis," *JMIR formative research*, vol. 4, no. 4, p. e15534, 2020.
- [37] H. M. Froome *et al.*, "The Effectiveness of the Foodbot Factory Mobile Serious Game on Increasing Nutrition Knowledge in Children," *Nutrients*, vol. 12, no. 11, p. 3413, 2020.
- [38] S. Nomura and H. Miyata, "Digitization of the approach to food and nutrition respecting individual health values," *Nutrition Reviews*, vol. 78, no. Supplement\_3, pp. 46–48, 2020.

# Environment with Technology as Highly Important Element for The Wellbeing of the Elderly

Wantonoro<sup>117</sup>, Moh Ali Imron<sup>118</sup>

## Introduction

The aging population continues to grow and it is predicted to be one billion elderly globally (12% of the total population in the world) on 2030, [1]. In addition, ageing increases the incidence of chronic diseases (cardiovascular disease, diabetes, etc) and, increases the cost of health care for chronic disease management [2, 3]. Due to aging phenomena [4], environment is identified as highly important element for the wellbeing of the elderly [5, 6]. The elderly become more sensitive and vulnerable to their environment [7]. Environment is the essential element in maintaining health and promoting recovery from illness [8, 9] related to competencies declined [10] and environmental changes including recent advances in environment technology [11]. Studies showed that environment is an important factor influencing the elderly's mobility, functional improvement, quality of life [12, 13], aging well-being [14] and mortality [15] for the elderly. In addition, environment challenges potentially lead to avoidance of challenging situations, restricted activity and further decline in health [16]. It is implied that the environments factor is essential for elderly's life.

The increasing number of frailties among elderly suggests that the environment plays a greater role in supporting independence in facing the declining abilities and is therefore a good target for nursing interventions [17]. Understanding the dynamic relationship between older person competencies and their environments becomes important due to increasing life expectancy and aging population and requirement for behavior healthy aging [18, 19], including for family care giver and health care provider.

The recent advances in environment technology have huge implications for the health and well-being of the elderly. Study reported some mental health benefits and fewer depressive symptoms, higher subjective well-being, improved cognitive performance, physical people's daily activities and practices that come

---

<sup>117</sup> Universitas 'Aisyiyah Yogyakarta, [onetos@yahoo.com](mailto:onetos@yahoo.com)

<sup>118</sup> Universitas 'Aisyiyah Yogyakarta

along with the use of technology [20-22]. However, there are still barriers in using technology especially for the elderly [23]. The elderly frequently use long-standing forms of technology and are slower to adopt newer forms of technology [22]. Environmental research to explore the relationship between caregiving and environmental (housing) for elderly has been conducted, however, there is a huge rejection towards the relation between the technology, caregiver and environment largely [24]. Therefore, this paper briefly reviews the benefit and challenge in some current studies on environment with technology for the elderly.

## **Discussion**

Being an elderly changes many human capabilities including the increase of functional limitations and number in morbidities. Then ageing populations demand of care services were increased [24]. Studies showed that the acceleration of demographic ageing raises significant long-term care services; as the ageing process brings with it the increase of dependency on care services [20, 24]. In addition, studies confirmed that functional status and living environment are important factor for the elderly's quality of life [12, 16, 25]. Based on the Lawton theory for the elderly, the relationship between "environmental press," or the mismatch between the person and his/her environment, and the adaptation to that environment is mediated through one's ability to cope [26], when stressors in health, cognition, or caregiver availability occur, environmental press may heighten for the elderly [27]. This indicated that environment is a very important factor for the elderly's well-being or quality of life. Therefore, developing friendly environment to overcome the limitation of the elderly competences is needed.

Benefit: The study reported that 80% of the elderly live independently at home with the help of technology [28]. In line with this, another studies showed that environment with technology makes everything easier for the elderly, for example to move to another place, sensory help function, and to connect with their loved ones and has made their life more convenient on the whole [20]. Using advanced devices to perform the elderly mobility function, such as powered wheelchairs and stair climbers, or providing assistance, such as well-placed grab bars in bathrooms or power-assisted chairs that facilitate sitting are recommended for the elderly [29, 30]. Some wearable technologies have been applied for the sensory of the elderly, for example low-vision assistive device has significant

adoption among older adults with age-related vision loss [31]. Hearing assistive technology improved the speech perception and connection and also orientation to the environment, as well as enabled greater mobility [32]. Also, a study showed that a willingness to use technology such as social media gives the experience toward not only a functional response but also an emotional one such as facilitated social contact [33]. A study reported the advantages of mobile health in the elderly self-care is improving the physical activity and reducing care costs [2]. A study reported the benefit of technological use for improving the quality of life such as online video platform for physical exercise [34] for physical well-being, Neuro-feed-back headband and, electroencephalogram with iPod-supported mindfulness training [35] and, mental training on alertness with a biofeedback device [36] mental well-being. Each elderly will need an individualized treatment plan to help ensuring the maximal quality of life in an environment with technology application [32]. It is confidently concluded that technology has become an important supporting element in the environment for elderly in order to maintain and increase independent and improve the quality of life.

Challenge: Technology has significant role in staying independent, active and healthy for the elderly. However, the capability to use technology varies and the level of technology are influenced by several factors including personal thoughts on technology use, the influence of social network, and role of the physical environment context in maximizing positive technology impact [37]. Another study informed the barriers to use technology including being older and sensory function; vision and hearing loss and, motoric difficulties, cognitive impairment function and, negative attitudes. Current review paper study identified five thematic categories of barrier including individual factor; technological functionality; social support; environmental factor such as location; and organizational factor such as privacy, trust, and the sharing of data [38]. In the other word, technology helps elderly for their physical and mental functional limitation. However, in the same time, physical, cognitive and, mental functional limitation was found to be the barrier for this vulnerable population. Therefore, the individual approaches and specific strategy are needed to be developed for the elderly.

In recent advanced technology, elderly person-centered care is crucial as healthcare systems. In person-centered care, the health care provider and the elderly collaborate in managing the healthcare

needs of the elderly. Then, the infrastructure roles and responsibilities of health care provider including nurse, physiotherapy, and midwifery are highly important in this technology era. Technological competency for the health care provider is the fundamental competency in order to give the health care services. Based on the theory of technological competency as caring [39], the capability to use technology for health care provider is an essential need. Health care practice needs to take the advantages of technological innovations in healthcare in order to provide a highly technological work environment for the elderly care. In addition, managing for integrating technologies in practice, educational, and research is highly suggested. Health care provider needs to possess the competency, adopt and do the adaptation with the rapid of change the health care technologies.

Lastly, the important thing is that we believed that technology has positive roles and functions in the care of elderly, however, health care provider would always be essential need for human interaction, empathy, and autonomy for the elderly care [40]. Human touch in care services,[41] would not be changed by advanced technologies, but the integration of human touch and technologies would improve the quality of care.

## **Conclusion**

Environment with advanced technology has positive implications for the health and well-being of the elderly. However, the elderly might have unique and individualized advanced technology need. Identifying the competency or capability of the elderly for technology treatment are recommended. In addition, improving the knowledge and competency both of the elderly (patient) and health care provider (nurse, physiotherapy, midwifery) in recent advanced technologies are important to develop patient care centered and improve quality of life of the elderly. Identified health care and environment with applied advanced technologies following the elderly's need and individual elderly competency are recommended for the elderly patient care.

## **References**

- [1] A. Ollevier, G. Aguiar, M. Palomino, and I. S. Simpelaere, "How can technology support ageing in place in healthy older adults? A systematic review," *Public Health Reviews*, vol. 41, p. 26, 2020/11/23 2020.

- [2] M. Shahbazi, H. Bagherian, M. Sattari, and S. Saghaeiannejad-Isfahani, "The opportunities and challenges of using mobile health in elderly self-care," *Journal of education and health promotion*, vol. 10, pp. 80-80, 2021.
- [3] K. I. Kim, S. S. Gollamudi, and S. Steinhubl, "Digital technology to enable aging in place," *Exp Gerontol*, vol. 88, pp. 25-31, Feb 2017.
- [4] United Nations, "World Population Ageing 2019 " 2020.
- [5] B. Schehl and J. Leukel, "Associations between individual factors, environmental factors, and outdoor independence in older adults," *European Journal of Ageing*, vol. 17, pp. 291-298, 2020/09/01 2020.
- [6] P. A. Lichtenberg, S. E. MacNeill, and B. T. Mast, "Environmental Press and Adaptation to Disability in Hospitalized Live-Alone Older Adults," *The Gerontologist*, vol. 40, pp. 549-556, 2000.
- [7] M. Byrnes, P. A. Lichtenberg, and C. Lysack, "Environmental Press, Aging in Place, and Residential Satisfaction of Urban Older Adults," *Sociological Practice*, vol. 8, pp. 50-76, 2006.
- [8] O. F. Jarrín, "The integrality of situated caring in nursing and the environment," *ANS. Advances in nursing science*, vol. 35, pp. 14-24, Jan-Mar 2012.
- [9] A. Deliktas, O. Korukcu, R. Aydin, and K. Kabukcuoglu, "Nursing Students' Perceptions of Nursing Metaparadigms: A Phenomenological Study," *Journal of Nursing Research*, vol. 27, 2019.
- [10] B. Hyman, G. Oden, and M. Wagner, "The Aging Process: Physiological Changes and Implications for Educators and Practitioners," *Activities, Adaptation & Aging*, vol. 34, pp. 148-153, 2010/05/28 2010.
- [11] H. Frumkin, L. Fried, and R. Moody, "Aging, climate change, and legacy thinking," *American journal of public health*, vol. 102, pp. 1434-1438, 2012.
- [12] M. Machón, I. Larrañaga, M. Dorronsoro, K. Vrotsou, and I. Vergara, "Health-related quality of life and associated factors in functionally independent older people," *BMC Geriatrics*, vol. 17, p. 19, 2017/01/14 2017.
- [13] Y. I. Shyu, J. Liang, J. F. Lu, and C. C. Wu, "Environmental barriers and mobility in Taiwan: is the Roy adaptation model applicable?," *Nurs Sci Q*, vol. 17, pp. 165-70, Apr 2004.
- [14] M. Ralston, "The Role of Older Persons' Environment in Aging Well: Quality of Life, Illness, and Community Context in South Africa," *Gerontologist*, vol. 58, pp. 111-120, Jan 18 2018.



- [15] Z. Feng, J. Falkingham, X. Liu, and A. Vlachantoni, "Changes in living arrangements and mortality among older people in China," *SSM - Population Health*, vol. 3, pp. 9-19, 2017/12/01/ 2017.
- [16] M. Rantakokko, T. Törmäkangas, T. Rantanen, M. Haak, and S. Iwarsson, "Environmental barriers, person-environment fit and mortality among community-dwelling very old people," *BMC Public Health*, vol. 13, p. 783, 2013/08/28 2013.
- [17] G. Kojima, A. E. M. Liljas, and S. Iliffe, "Frailty syndrome: implications and challenges for health care policy," *Risk management and healthcare policy*, vol. 12, pp. 23-30, 2019.
- [18] D. d. S. Albuquerque, D. A. R. Amancio, I. d. A. Günther, and M. I. G. Higuchi, "Contribuições teóricas sobre o envelhecimento na perspectiva dos estudos pessoa-ambiente," *Psicologia USP*, vol. 29, pp. 442-450, 2018.
- [19] M. Kylén, C. Löfqvist, M. Haak, and S. Iwarsson, "Meaning of home and health dynamics among younger older people in Sweden," *European Journal of Ageing*, vol. 16, pp. 305-315, 2019/09/01 2019.
- [20] W. J. Chopik, "The Benefits of Social Technology Use Among Older Adults Are Mediated by Reduced Loneliness," *Cyberpsychology, behavior and social networking*, vol. 19, pp. 551-556, 2016.
- [21] H. R. Marston and C. B. A. Musselwhite, "Improving Older People's Lives Through Digital Technology and Practices," *Gerontology and Geriatric Medicine*, vol. 7, p. 23337214211036255, 2021/01/01 2021.
- [22] Y.-H. Wu, M. Lewis, and A.-S. Rigaud, "Cognitive Function and Digital Device Use in Older Adults Attending a Memory Clinic," *Gerontology and Geriatric Medicine*, vol. 5, p. 2333721419844886, 2019/01/01 2019.
- [23] E. Vaportzis, M. G. Clausen, and A. J. Gow, "Older Adults Perceptions of Technology and Barriers to Interacting with Tablet Computers: A Focus Group Study," *Frontiers in psychology*, vol. 8, pp. 1687-1687, 2017.
- [24] P. Carnemolla, "Ageing in place and the internet of things – how smart home technologies, the built environment and caregiving intersect," *Visualization in Engineering*, vol. 6, p. 7, 2018/12/06 2018.
- [25] T. Rantanen, E. Portegijs, A. Viljanen, J. Eronen, M. Saajanaho, L.-T. Tsai, *et al.*, "Individual and environmental factors underlying life space of older people – study protocol and design of a cohort

- study on life-space mobility in old age (LISPE)," *BMC Public Health*, vol. 12, p. 1018, 2012/11/22 2012.
- [26] M. P. Lawton, P. G. Windley, and T. O. Byerts, *Aging and the environment: Theoretical approaches* vol. 7: Springer Publishing Company, 1982.
- [27] J. D. Crist, C. Lacasse, L. R. Phillips, and J. Liu, "LAWTON'S THEORY OF PERSON-ENVIRONMENT FIT: THEORETICAL FOUNDATIONS FOR DETECTING TIPPING POINTS," *Innovation in Aging*, vol. 3, pp. S597-S597, 2019.
- [28] A. Alaiad, L. Zhou, and G. Koru, "An empirical study of home healthcare robots adoption using the UTUAT model," 2013.
- [29] E. G. Christoforou, S. Avgousti, N. Ramdani, C. Novales, and A. S. Panayides, "The Upcoming Role for Nursing and Assistive Robotics: Opportunities and Challenges Ahead," *Frontiers in digital health*, vol. 2, pp. 585656-585656, 2020.
- [30] M. Hersh, "Overcoming Barriers and Increasing Independence – Service Robots for Elderly and Disabled People," *International Journal of Advanced Robotic Systems*, vol. 12, p. 114, 2015/08/01 2015.
- [31] C. McGrath and A. M. Corrado, "The environmental factors that influence technology adoption for older adults with age-related vision loss," *British Journal of Occupational Therapy*, vol. 82, pp. 493-501, 2019/08/01 2018.
- [32] P. B. Kricos, "Hearing assistive technology considerations for older individuals with dual sensory loss," *Trends in amplification*, vol. 11, pp. 273-279, 2007.
- [33] M. d. Haan, R. Brankaert, G. Kenning, and Y. Lu, "Creating a Social Learning Environment for and by Older Adults in the Use and Adoption of Smartphone Technology to Age in Place," *Frontiers in Public Health*, vol. 9, 2021-June-16 2021.
- [34] M. Dekker-van Weering, S. Jansen-Kosterink, S. Frazer, and M. Vollenbroek-Hutten, "User Experience, Actual Use, and Effectiveness of an Information Communication Technology-Supported Home Exercise Program for Pre-Frail Older Adults," *Frontiers in Medicine*, vol. 4, 2017-November-27 2017.
- [35] S. Bhayee, P. Tomaszewski, D. H. Lee, G. Moffat, L. Pino, S. Moreno, *et al.*, "Attentional and affective consequences of technology supported mindfulness training: a randomised, active control, efficacy trial," *BMC Psychology*, vol. 4, p. 60, 2016/11/29 2016.
- [36] A. Milewski-Lopez, E. Greco, F. van den Berg, L. P. McAvinue, S. McGuire, and I. H. Robertson, "An evaluation of alertness training

- for older adults," *Frontiers in Aging Neuroscience*, vol. 6, 2014-April-15 2014.
- [37] S. T. M. Peek, K. G. Luijkx, M. D. Rijnaard, M. E. Nieboer, C. S. van der Voort, S. Aarts, *et al.*, "Older Adults' Reasons for Using Technology while Aging in Place," *Gerontology*, vol. 62, pp. 226-237, 2016.
- [38] J. Wilson, M. Heinsch, D. Betts, D. Booth, and F. Kay-Lambkin, "Barriers and facilitators to the use of e-health by older adults: a scoping review," *BMC Public Health*, vol. 21, p. 1556, 2021/08/17 2021.
- [39] J. A. T. Pepito, R. C. Locsin, and R. E. Constantino, "Caring for Older Persons in a Technologically Advanced Nursing Future," *Health*, 2019.
- [40] J. Molina-Mula and J. Gallo-Estrada, "Impact of Nurse-Patient Relationship on Quality of Care and Patient Autonomy in Decision-Making," *International journal of environmental research and public health*, vol. 17, p. 835, 2020.
- [41] J. Arcega, I. Autman, B. De Guzman, L. Isidienu, J. Olivar, M. O'Neal, *et al.*, "The Human Touch: Is Modern Technology Decreasing the Value of Humanity in Patient Care?," *Crit Care Nurs Q*, vol. 43, pp. 294-302, Jul/Sep 2020.

# Social Media Use during the Covid-19 Pandemic and Beyond: A Uses and Gratifications Perspective

Wichitra Yasya<sup>119</sup>, Nani Nurani Muksin<sup>120</sup>

## Introduction

In communication science, the development of the paradigm follows developments in human communication which are influenced by the social conditions of society, technology and media. Based on the development of this era of human communication, the paradigm in communication science has also developed through the process of the scientific revolution. In the early development of communication, theorists saw communication as a linear process. This is influenced by communication research that focuses on mass media whose strategy is propaganda. At this time communication is seen as a one-way transmission model, focusing on the single voice of the propagandist, passive and atomistic audiences and the context of the state that is taken for granted by the audience [3].

Communication is a process. Thus, the communication research paradigm is based or grouped according to the level of the communication process. McQuail [4] describes 6 levels of the social communication process, including:

1. Intrapersonal or intrapersonal communication
2. Interpersonal or interpersonal communication
3. Intragroup or in-group communication
4. Intergroup/association or communication between groups/associations
5. Institutional/organizational or organizational/institutional communication
6. Society-wide or communication with the wider community (mass communication)

However, with rapid globalization and technological developments, the communication patterns per level are becoming more complex. The development of information and communication technology (ICT) produces new forms of media that expand and change the entire spectrum of socio-technological possibilities for communication. Communication, and consequently the media as

---

<sup>119</sup> Bhayangkara Jakarta Raya University

<sup>120</sup> University of Muhammadiyah Jakarta

well, has converged. Society has also advanced, evolving into a society which achieves a high degree of convergence between cyberspace (virtual space) and physical space (real space). This is called Society 5.0, defined as “a human-centered society that balances economic advancement with the resolution of social problems by a system that highly integrates cyberspace and physical space” [5].

In this era of Society 5.0, technology plays a key role in people's lives. The key role of technology not limited to its use, but more to how humans can generate value by creating and utilizing technology and digital devices. If the previous focus on the industrial revolution 4.0 era was the technology and information, in the era of Society 5.0 the key is how digital transformation with technology and data is used creatively and innovatively to create a pluralistic society that is able to solve problems and generate values for a meaningful life [6]. In Society 5.0, human intelligence is combined with artificial intelligence to make human work more effective, efficient and economical with more massive results.

One aspect that defines Society 5.0 is its use of social media. Social media as an extension of human communication mediated by technology has brought upon many repercussions in people's lives. Amplified with the Covid-19 pandemic that made everyone in many parts of the world be confined to their own homes, social media becomes more prominent in people's lives. This paper will discuss social media as one defining aspect of Society 5.0 through the lens of uses and gratifications theory, by providing an introduction of new media concept which develops into social media, and how social media is used in Society 5.0, particularly during the Covid-19 pandemic and moving forward into the “metaverse” – an environment where the “cyber” and “physical” space might be blurred or fused together.

## **Discussion**

### **Social Media**

Social media is a new form of information and communication technology (ICT) which is developing very rapidly and is known to have an influence on people's daily lives. Humans are social creatures, and social media is a new place for them to express themselves. Basically, social media is a form of media that "employ mobile and web-based technologies to create highly interactive platforms via which individuals and communities share,

co-create, discuss, and modify user-generated content." [14, p. 241]. The forms and categories of social media are constantly changing with technological developments but currently consist of weblogs (or "blogs"), microblogs, social networking sites and media-sharing sites, RSS and other syndicated web feeds, wikis, social bookmarking, mashups, widgets, microblogging, and others [15]. Social media – like other forms of ICT – has an impact on many areas of modern human life. Among other things, in the fields of politics, business, education and socio-culture, ICTs and social media are heavily influenced [16]. Uimonen [17] sees that the power of social media lies in its ability to connect people, mediate, and mobilize networks. Social media is also more inclusive because it can provide opportunities to reach members of a population that are traditionally underserved [18]. Furthermore, according to Chou et al. [18], social media successfully penetrated the population, regardless of education level, ethnicity or race. Regarding the power of social media, Shirky [19, p. 2] argues that these networked populations now have access to more information, more opportunities to join in public debate, and more ability for collective action in the light of the communications landscape getting denser, more complicated, and more participative.

### **Uses and Gratifications Theory in Social Media**

The perspective of Uses and Gratifications theory is widely applied to explain the use of social media. Uses and Gratifications (U&G) theory looks at how a person uses mass media, assuming individuals will select media and content to meet their needs and desires [23]. In other words, Uses and Gratifications theory explains the use of mass media by audiences, which are text, or images, both sounding and moving in the form of writing or audio-visual broadcasts (current terms: posted, shared or forwarded) and they those who do so gain a certain amount of satisfaction [24]. There are three elements in this Uses and Gratifications model, namely:

1. The audience is seen to be active, meaning that the important role of media benefits is assumed to be target-oriented.
2. In the process of mass communication, many initiatives to link between need gratification and media choice lie with the audience.
3. The media compete with other sources of fulfillment.

The initial research on Uses and Gratifications was conducted by Katz et al. [25] who views the media as a tool that individuals use for relationships—both initiating and breaking

relationships—with others. The research resulted in five categories of media use needs, among others:

1. Cognitive needs: to obtain information, knowledge and understanding.
2. Affective needs: emotional, pleasurable, or aesthetic experience.
3. Personal integrative needs: strengthen credibility, self-confidence, stability, and status.
4. Social integrative needs: strengthen relationships with family, friends, and so on.
5. Tension release needs: escape and diversion.

In relation to media effects that is more dependent on the audience rather than the message itself, with focus on: (1) the social and psychological origins of (2) needs which generate (3) expectations of (4) the mass media, or other sources, which lead to (5) differential patterns of media exposure (or engagement in other activities) resulting in (6) need gratifications and (7) other consequences, perhaps mostly unintended ones [25, p. 510].

Thus, the main purpose of using this theory is to explain how individuals use media to gratify their needs; to understand the motives of media behavior; and to identify functions or consequences arising from needs, motives, and behaviors [26].

Although initially the Uses and Gratifications theory was used to explain the use of mass media such as television, radio, newspapers, and communication technology such as mobile phones, along with the development of the media, this theory has also been widely applied to research on the use of social media. The reason for the widespread use of social media research using the Uses and Gratifications theory is because this theory focuses on audiences who have control over choosing media, while social media is a type of media where users can freely choose the content they see and the features used. Uses and Gratifications may be an appropriate approach in analyzing new media phenomena such as social media because of the requirements for the active needs of this audience [27].

### **Social Media Use during the Covid-19 Pandemic... and Beyond**

During the Covid-19 pandemic, social media use has greatly increased as people are confined indoors, and social media became the main tool for communication and doing all aspects of their daily lives such as work, school, shop, etc. According to a survey by Facebook and YouGov, more than 140 million people living in

Indonesia are active in social media [28]. This number accounts for more than half of Indonesia's population. In summary, there was about 15.5% growth in Internet users during the pandemic [29]. Worldwide, social media platforms increased to 61% in usage, where in the early days of the pandemic there was more than 40% increase in the use of Facebook and Instagram, 70% increase of messaging platforms such as Whatsapp and Facebook Messenger, and views on live streams doubled [30].

In line with Uses and Gratifications Theory, people use social media during the pandemic in the five categories of needs. The first is cognitive needs, this is when people use social media to gain information – especially on the Coronavirus and the pandemic itself. According to a study by Rohmah [31], 93% of respondents use social media for cognitive needs, to gain information on Covid-19. On the other hand, access to social media meant anyone can create and distribute any kind of information, without a proper gatekeeping mechanism to ensure the information is factually correct. This resulted in an infodemic, or overabundance of information where the accurate and erroneous (including hoaxes and misinformation) all mixed together during an epidemic [32]. Authorities have attempted to curb the spread of infodemic, but it is inevitable. Infodemic could be as deadly as the coronavirus itself. A hoax spread by a medical doctor that spread on social media allegedly caused a man in Tegal city to die because he refused treatment and hospitalization, making his condition worsen to the point that he could not be saved [33]. To curb the infodemic is to distill the sheer quantity of information, which can be done by making sure articles and research produced on Covid-19 must also be as accurate and factual as possible, fact checking and peer review to create effective public policy, increasing science literacy and eHealth literacy to combat inaccurate and biased media coverage, and information monitoring and social listening on social media [34].

Social media have also been used for affective needs. Through features that enable virtual communities, social media such as Facebook can provide platforms for social and emotional support during dark times such as mortality and morbidity due to Covid-19. Emotional or moral support was exchanged in social media through their virtual communities, with people claiming they provide or give moral support, as well as receiving moral support [28]. People may also post emotional messages on their social media as a form of emotional release, although in some cases this may be



counterproductive as negative sharing receives less feedback, reduces perceived connectedness in the online community, and generates concerns about the social cost of a negative self-presentation [35].

In terms of personal integrative needs, social media fosters stability in the midst of the uncertainty of pandemic. Through providing information and support, social media use play the crucial role of a buffer, as social media can manage and mitigate anxiety during the pandemic [36]. More than half of respondents in a uses and gratifications study of social media during the pandemic also stated with social media, they are able to explore their own selves [31].

Social media is also reported to be a replacement and complementor of relationships with family and friends [31]. This fulfills the social integrative needs. As Covid-19 restrictions meant people are not able to physically meet, social media became a major platform for them to communicate. A study reported a 70% increase of messaging platforms such as Whatsapp and Facebook Messenger [30]. Other than social media, other platforms such as Zoom, Google Meet, and Microsoft Teams are also used to communicate virtually that is made as similar as possible to an offline interaction.

Lastly, social media is used as an escape and diversion, in other words for tension release needs. As the pandemic create fear an anxiety, accessing social media may alleviate that anxiety [36]. This may be the case when people use social media to participate or share and produce content, as it is correlated with greater sense of wellbeing, while simply being a passive social media user who just watch or scroll may create a feeling of jealousy and helplessness which are detrimental to mental health [37], [38].

Based on the literature as presented above, most studies report social media use related to cognitive needs, although its use needs to be carefully managed as to not create an overabundance of information called the infodemic, which may be detrimental to one's health and wellbeing.

In the future, social media use may provide more nuanced gratifications. The pandemic has created the "Covid effect", where we have a taste of what the future of life will be like. We cannot go back to being "offline" like we used to be even though the pandemic is over and it is safe for us to conduct activities in physical space instead of virtual space. Instead, we will still continue the virtual way, in a hybrid setting, as is the characteristic of Society 5.0. Along with other

technological features such as artificial intelligence, Internet of Things, virtual reality, augmented reality, face recognition, GPS, cryptocurrency, 5G connections, and big data, in the not too long future the metaverse may become mainstream. The metaverse, popularized since Mark Zuckerberg, the founder of Facebook, has rebranded his company to the name Meta, is a proposed version of the internet that incorporates three-dimensional virtual environments [39]. It is the concept of a highly immersive virtual world where people gather to socialize, play, and work [40]. Meta comes from the Greek word that means 'beyond', in this case, the prefix usually used to describe something that transcends the current reality [40]. Thus, in the future, the cyber and physical spaces that are increasingly getting close together in Society 5.0, might be perfectly fused to create a brand-new reality that the Metaverse offers us in the future.

## **Conclusion**

Humans have always evolved defined by their technology, namely communication technology. In Society 5.0, one communication technology that defines the society is social media. From the lens of Uses and Gratifications Theory, social media can be used across the five categories of needs, although the most dominant is for fulfilment of cognitive needs. In the future, the gratifications that social media offer might be more nuanced and amplified, as the future brings to creation of the metaverse where the cyber and physical spaces that in Society 5.0 are linked together, becomes blurred and may be perfectly fused to create a new reality where people gather to socialize, play, and work in a highly immersive, three-dimensional virtual world.

## **References**

- [1] H. Cangara, *Pengantar Ilmu Komunikasi*. Jakarta [ID]: PT RajaGrafindo Persada, 2008.
- [2] Riswandi, *Ilmu Komunikasi*. Yogyakarta [ID]: Graha Ilmu, 2009.
- [3] K. B. Jensen and W. Russell Neuman, "Evolving paradigms of communication research," *Int. J. Commun.*, vol. 7, pp. 230–238, 2013.
- [4] D. McQuail, *McQuail's Mass Communication Theory*. London [UK]: Sage, 2010.
- [5] Cabinet Office Government of Japan, "Society 5.0." [https://www8.cao.go.jp/cstp/english/society5\\_0/index.html](https://www8.cao.go.jp/cstp/english/society5_0/index.html)

- (accessed Mar. 26, 2021).
- [6] Keidanren, "Society 5.0: Co-creating the Future," 2018. [https://www.keidanren.or.jp/en/policy/2018/095\\_booklet.pdf](https://www.keidanren.or.jp/en/policy/2018/095_booklet.pdf) (accessed Mar. 26, 2021).
  - [7] G. Cardoso, "From Mass to Networked Communication: Communicational models and the Informational Society.," *Int. J. Commun.*, vol. 2, p. 44, 2008, [Online]. Available: <http://ijoc.org/index.php/ijoc/article/view/19>.
  - [8] M. Castells and G. Cardoso, *The Network Society: From Knowledge to Policy*, vol. 72. Washington DC [US]: Johns Hopkins Center for Transatlantic Relations, 2005.
  - [9] M. Castells, "Communication, Power and Counter-Power in the Network Society," *Int. J. Commun.*, vol. 1, no. 1, pp. 238–266, 2007.
  - [10] M. Castells, *Communication Power*. New York [US]: Oxford University Press, 2009.
  - [11] P. B. O'Sullivan and C. T. Carr, "Masspersonal communication: A model bridging the mass-interpersonal divide," *New Media Soc.*, vol. 20, no. 3, pp. 1161–1180, 2018, doi: 10.1177/1461444816686104.
  - [12] M. French and N. N. Bazarova, "Is Anybody Out There?: Understanding Masspersonal Communication Through Expectations for Response Across Social Media Platforms," *J. Comput. Commun.*, vol. 22, no. 6, pp. 303–319, 2017, doi: 10.1111/jcc4.12197.
  - [13] C. T. Carr and R. A. Hayes, "Social Media: Defining, Developing, and Divining," *Atl. J. Commun.*, vol. 23, no. 1, pp. 46–65, 2015, doi: 10.1080/15456870.2015.972282.
  - [14] J. H. Kietzmann, K. Hermkens, I. P. McCarthy, and B. S. Silvestre, "Social media? Get serious! Understanding the functional building blocks of social media," *Bus. Horiz.*, vol. 54, no. 3, pp. 241–251, 2011, doi: 10.1016/j.bushor.2011.01.005.
  - [15] B. Supradono and A. N. Hanum, "Peran Sosial Media Untuk Manajemen Hubungan dengan Pelanggan Pada Layanan E-Commerce," *Value Added/ Maj. Ekon. dan Bisnis*, vol. 7, no. 2, 2011.
  - [16] J. R. Situmorang, "Pemanfaatan Internet Sebagai New Media Dalam Bidang Politik, Bisnis, Pendidikan Dan Sosial Budaya," *J. Adm. Bisnis*, vol. 8, no. 2, pp. 77–91, 2013.
  - [17] P. Uimonen, "Social and Mobile Media in ICT4D," in *Social Media in Development Cooperation*, R. S. Braskov, Ed. Roskilde [DK]: Ørecomm - Centre for Communication and Glocal Change, 2012.

- [18] S. W. Chou, M. Y. Hunt, B. E. Beckjord, P. R. Moser, and W. B. Hesse, "Social Media Use in the United States: Implications for Health Communication," *J Med Internet Res*, vol. 11, no. 4, p. e48, 2009, doi: 10.2196/jmir.1249.
- [19] C. Shirky, "The Political Power of Social Media," *Foreign Aff.*, vol. 9, no. 1, pp. 1-7, 2010.
- [20] T. Dowerah Baruah, "Effectiveness of Social Media as a tool of communication and its potential for technology enabled connections: A micro-level study," *Int. J. Sci. Res. Publ.*, vol. 2, no. 5, pp. 1-10, 2012, [Online]. Available: [www.ijsrp.org](http://www.ijsrp.org).
- [21] J. Caron and J. Light, "'Social Media has Opened a World of Open communication:' Experiences of Adults with Cerebral Palsy who use Augmentative and Alternative Communication and Social Media," *AAC Augment. Altern. Commun.*, vol. 32, no. 1, pp. 25-40, 2016, doi: 10.3109/07434618.2015.1052887.
- [22] S. L. Buglass, J. F. Binder, L. R. Betts, and J. D. M. Underwood, "Motivators of online vulnerability: The impact of social network site use and FOMO," *Comput. Human Behav.*, vol. 66, pp. 248-255, 2017, doi: 10.1016/j.chb.2016.09.055.
- [23] A. Papacharissi and Z. Mendelson, "Toward a new(er) sociability: Uses, gratifications and social capital on Facebook," in *Media perspectives for the 21st century*, E. Papathanassopoulos, Ed. New York (US): Routledge, 2011, pp. 212-230.
- [24] L. Suparmo, "Uses and Gratifications Theory dalam Media Sosial WA (WhatsApp)," *CommunicologyJurnal Ilmu Komun.*, vol. 6, no. 2, pp. 27-37, Dec. 2017, doi: 10.21009/communicology.062.02.
- [25] E. Katz, J. G. Blumler, and M. Gurevitch, "Uses and Gratifications Research," *Public Opin. Q.*, vol. 37, no. 4, p. 509, 1973, doi: 10.1086/268109.
- [26] G. Shao, "Understanding the appeal of user-generated media: a uses and gratification perspective," *Internet Res.*, vol. 19, no. 1, pp. 7-25, 2009, doi: 10.1108/10662240910927795.
- [27] W. Y. Liu, "A Historical Overview of Uses and Gratifications Theory," *Cross-Cultural Commun.*, vol. 11, no. 9, pp. 71-78, 2015, doi: 10.3968/7415.
- [28] MediaIndonesia.com, "140 Juta Pengguna Media Sosial di Indonesia Aktif Selama Pandemi," *Media Indonesia*, 2021. .
- [29] C. Febriyani, "Selama Pandemi, Pengguna Internet di Indonesia Tumbuh 15,5 Persen," *Industry.co.id*, Jun. 18, 2021.
- [30] T. Nabity-Grover, C. M. K. Cheung, and J. B. Thatcher, "Inside out and outside in: How the COVID-19 pandemic affects self-

- disclosure on social media," *Int. J. Inf. Manage.*, vol. 55, p. 102188, Dec. 2020, doi: 10.1016/j.ijinfomgt.2020.102188.
- [31] N. N. Rohmah, "Media Sosial Sebagai Media Alternatif Manfaat dan Pemuas Kebutuhan Informasi Masa Pandemi Global Covid 19 (Kajian Analisis Teori Uses And Gratification)," *Al-I'lam J. Komun. dan Penyiaran Islam*, vol. 4, no. 1, pp. 1–16, 2020, [Online]. Available: <https://journal.ummat.ac.id/index.php/jail/article/view/2957/1905>.
- [32] J. Galvão, "COVID-19: the deadly threat of misinformation," *Lancet Infect. Dis.*, vol. 21, no. 5, p. e114, 2021, doi: 10.1016/S1473-3099(20)30721-0.
- [33] M. Wareza, "Hoax dari dr Lois Akhirnya Memakan Korban Jiwa," *CNBC Indonesia*, Jakarta, Jul. 17, 2021.
- [34] G. Eysenbach, "How to Fight an Infodemic: The Four Pillars of Infodemic Management," *J Med Internet Res*, vol. 22, no. 6, p. e21820, 2020, doi: 10.2196/21820.
- [35] R. Shao, Z. Shi, and D. Zhang, "Social Media and Emotional Burnout Regulation During the COVID-19 Pandemic: Multilevel Approach," *J. Med. Internet Res.*, vol. 23, no. 3, p. e27015, Mar. 2021, doi: 10.2196/27015.
- [36] Y. Marzouki, F. S. Aldossari, and G. A. Veltri, "Understanding the buffering effect of social media use on anxiety during the COVID-19 pandemic lockdown," *Humanit. Soc. Sci. Commun.*, vol. 8, no. 1, p. 47, Dec. 2021, doi: 10.1057/s41599-021-00724-x.
- [37] A. Masciantonio, D. Bourguignon, P. Bouchat, M. Balty, and B. Rimé, "Don't put all social network sites in one basket: Facebook, Instagram, Twitter, TikTok, and their relations with well-being during the COVID-19 pandemic," *PLoS One*, vol. 16, no. 3 March, pp. 1–14, 2021, doi: 10.1371/journal.pone.0248384.
- [38] B. Omar and W. Dequan, "Watch, share or create: The influence of personality traits and user motivation on TikTok mobile video usage," *Int. J. Interact. Mob. Technol.*, vol. 14, no. 4, pp. 121–137, 2020, doi: 10.3991/IJIM.V14I04.12429.
- [39] Collins English Dictionary, "Metaverse," *HarperCollins Publishers*, 2021. <https://www.collinsdictionary.com/dictionary/english/metaverse> (accessed Dec. 04, 2021).
- [40] Merriam-Webster, "What does 'metaverse' mean?" <https://www.merriam-webster.com/words-at-play/meaning-of-metaverse> (accessed Dec. 04, 2021).

# **The Implication of Project-Based Teaching on Undergraduate Students' Creativity**

Wiwin Sri Hidayati

## **Introduction**

5.0 society era was first time introduced by Japan in 2019. Life skills that consist of creativity, critical thinking, communication, and collaboration are fundamental for students. Thus, those four skills should be developed in the process of teaching. Teaching for higher education, in particular to mathematics education program, most likely develop those four skills. Creativity relates to critical thinking, while communication applies as means to implement the result of creativity and critical thinking. Furthermore, collaboration likely exists in some assignments that produce products. Therefore, as educators, especially lecturers, should be able to select appropriate teaching models. Project-based teaching is one teaching model that allows students to develop their creativity, critical thinking, communication, and collaboration. This teaching model is as mandated in Ministerial Regulation of Education and Culture No. 3/2020 about National Standard of Higher Education [1].

One discourse in undergraduate program of mathematics education is teaching media. Considering the paradigm of 5.0 society era, lecturers are no longer play a central role in the process of their teaching. Otherwise, it should be student-centered in order to encourage students' creativity, critical thinking, communication, and collaboration. Looking into some previous studies, it suggests that project-based teaching may improve and develop students' creativity and critical thinking[2], [3]. Besides, it may also improve students' mathematical communication[4]. This teaching model builds students' collaboration by allowing them to construct media for teaching mathematics course. The media refers to a set of concrete objects constructed as means to deliver an object of mathematics course in teaching process.

The object of mathematics course that consists of facts, concepts, operations, and principles are all abstract. Hence, the existence of media for teaching mathematics may help students to easily understand the course. Fact is any conventions in mathematics. It consists of terms, names, notations, signs, or symbols. Concept is an abstract idea to classify objects whether or not they are the example of the concept. It can be learned through definitions. Definition is an

expression that borders concepts. Operation is a function to get a single element from either one or more identified elements. Moreover, principle is a composite of mathematical basic objects that consist of some facts, concepts, and are linked to an operation. It can be in the form of theorems or propositions, axioms, and features.

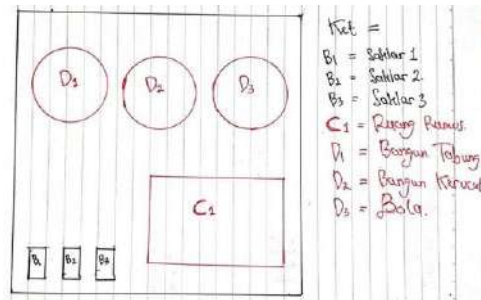
Project-based teaching is a challenge for undergraduate students to construct mathematics teaching media. In its implementation, however, lecturers need to get feedback from their students as well. Therefore, this research also analyzed the feedback that students gave to their lecturers. The feedback was useful as reflection for lecturers. In addition, it aimed to see students' responses. Analyzing the implication of project-based teaching on undergraduate students' creativity involved (1) proficiency, (2) fluency, (3) originality, and detail (5) [5].

In relation to 5.0 society era that puts human-centered and technology-based societal concept in the first place, the media of teaching must be compatible in anywhere both online

## **Discussion**

This section described the result of this qualitative research held in Undergraduate Program of Mathematics Education at one of advance schools in Jombang. It was held in 2021. The prospective subject of this study was 24 undergraduate students who took a course of teaching media. They were divided into 8 groups. They were selected for their technology-tasted media, and the selected one was entitled the light arch. The primary instrument of this study was the researcher self, while the supporting instruments were interview and a rubric of assessment for math teaching media.

Students' Creativity in Constructing Mathematics Teaching Media. The following figures showed the construction of mathematics teaching media entitled the light arch by. The following figures showed the construction of mathematics teaching media entitled *the light arch* by the subject of this study.



**Figure 1. Initial Design**



**Figure 2. The Light Arch**

According to the media constructed by the subject, the implication of project-based teaching on students' creativity involved (1) proficiency, (2) fluency, (3) originality, and (4) detail. Students' proficiency was seen from their proposal about the needs analysis, as follow. The abstract delivery. We chose the elements of curved side forms as our teaching material. Based on both National Curriculum 2013 and Covid-19 Urgent Curriculum, this material is taught to the ninth graders of public school/religion-based school/any other schools with the same level of education. This material involves some



abstract concepts related to the correlation between circumference and tube surface area, the correlation between segments and cone surface area, and etc. therefore, it needs a media to clearly explain the elements of those abstract concepts in order to make students easily understand them. The process of transferring the knowledge to the students was through a concrete experience about the abstract elements so that they could directly identify, express, and explain those elements well.

It was apparently seen from an excerpt of the proposal they proposed that the subject analyzed the importance of media for teaching the elements of curved side forms, which was also based on National Curriculum 2013 and Covid-19 Urgent Curriculum, this material must be taught to the ninth graders of public schools/religion-based schools/ any other schools with the same level. Moreover, this material was selected by considering the abstract concepts related to the correlation between circumference and tube surface area as well as the correlation between segments and cone surface area. The subject decided that it needed a media to clearly show those abstract elements to the students so that they would be no longer need to memorize the elements of any curved-side forms.

Fluency was revealed from students' competence to see problems in various perspectives. In this case, the subject found that, in addition to seeing the importance of media for teaching mathematics, this current covid-19 pandemic era forced students to learn online. Hence, It encouraged the subject to construct an attractive media by utilizing a simple technology such as indicator lamps. Besides, they also found an alternative solution related to the teaching media they had constructed that it was compatible for both online and offline teaching. Next, Originality was revealed from the uniqueness of having ideas in constructing teaching media for mathematics course. The subject made it attractive by giving some ornaments of lamps and rotatable. The result of this construction contained novelty compared to the previous one. This far, the existing media was merely in the form of skeleton, while what they had constructed resembled the real one. The originality was also seen from Figure 1 which was still a simply initial design and turned into Figure 2. The detail was revealed from their competence to explain their product with their own words, as follow.

Researcher : Please tell me how did you construct this media from the beginning to the end?

Subject : Ok, Mam. We made the surface areas of tube and cone using mica paper, a cover for the tube, and a roulette of tube, cone, and ball. Then, we prepared a box to put those three geometrical objects. The box was made from a 100x50cm plywood with 0.5 cm thickness. We made some holes for electric switch and a rotating axle for the roulette. Next, we put the roulette into the axle along with the geometrical objects. We put in the electric switch as well using bolts and nuts. Afterward, we put in the rotator and connected axle of each object. Then, we installed the electrical circuits connected to the rotator and the LED strip lamps which previously put in every part we wanted such as the curved-sides, the skeleton of the objects, and etc. Last, we plug in some dry-cell batteries appropriately.

Researcher : Why did you give it lamps?  
Subject : To make it different from any other existing media, Mam. Besides, we wanted to attract students' attention when using it. We thought that these colorful lamps might motivate them to try out the media we constructed.

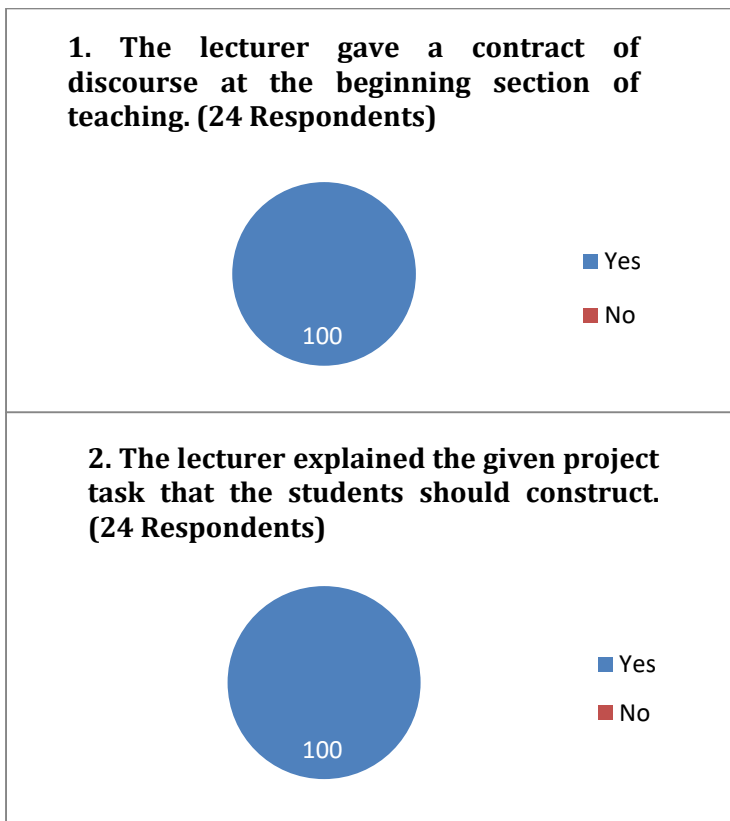
Researcher : Could you tell me why you constructed a teaching media related to curved- side geometrical object? Why not any other material?

Subject : We chose one of mathematics course materials with abstract elements on its delivery. These curved-side geometrical objects are taught to the ninth graders of public schools/religion-based schools/ and any other schools with the same level of education. As we know, they are still either 14 or 15 years old and thus absolutely need media for learning mathematics, especially those related to abstract things.

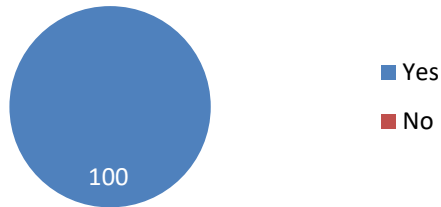
The subject's creativity was generally revealed from these four indicators including: (1) proficiency, (2) fluency, (3) originality, and (4) detail. It was consistent with some previous studies [7], [8].

### Analysis of Student Response

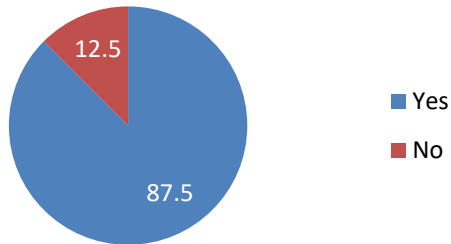
The following figure showed the result of questionnaires distributed to 24 students on project-based teaching



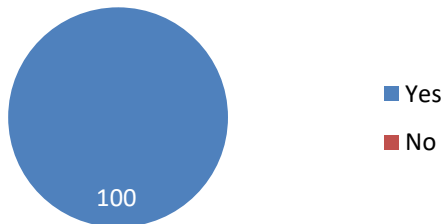
**3. The lecturer gave a contract of discourse at the beginning section of teaching. (24 Respondents)**



**4. The lecturer gave enough time to complete the project (24 Respondents)**



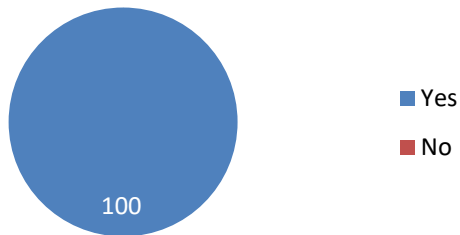
**5. The lecturer allowed each group to consult the project they were constructing (24 Respondents)**



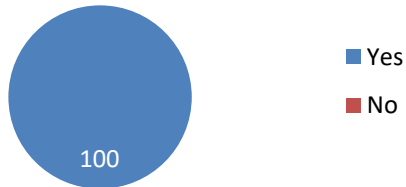
**6.The lecturer allowed each group to present their project (24 Respondents)**



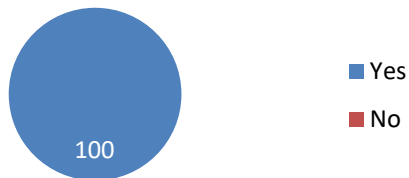
**7. The lecturer gave feedback and/or suggestion on the project result of each group (24 Respondents)**



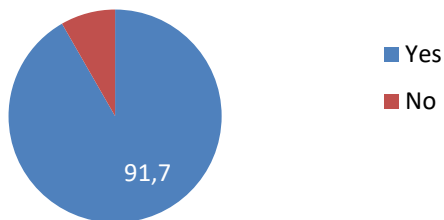
**8. The lecturer gave feedback and/or suggestion on the project result of each group (24 Respondents)**



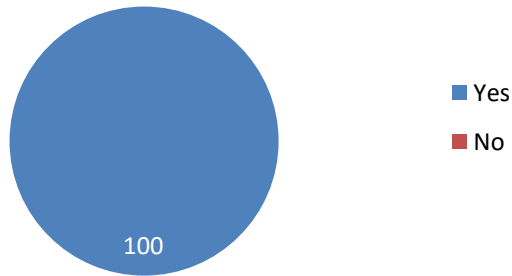
**9. The lecturer assisted and had a teaching integration through public service in particular school society (24 Respondents)**



**10. The lecturer gave adequate time and chance to make the final report of their project (24 Respondents)**



**11. As undergraduate student, I think that project-based teaching model is appropriate for the course of teaching media. (24 Respondents)**



Give reasons why undergraduate students feel either happy or unhappy with project-based teaching model on a course of teaching media? (23 Respondents)

1. Because undergraduate students may construct a media as means to teach students in school
2. Happy. It is because undergraduate students can make a media that will be useful as means for teaching in school. In addition, they will not only focus on formulas, numbers, but also making creativity.
3. I am happy because I will be able to make a media and simultaneously present it as one that can be beneficial for student
4. Undergraduate students will be happy as they can directly implement what they learned and give contribution to others.
5. Happy, it is because we will more understand about how to create a teaching media, how to present it, and how we can help students in school
6. I think, given that this current pandemic is not over yet, object-based teaching model is great. In addition to minimizing new clusters due to crowd, this model may motivate students to create ideas by considering their surroundings. It is very useful for undergraduate students as they can use it as means for teaching in the future. They can also have experiences as

- prospective teachers by creating ideas and reflecting them into a good teaching both online and offline.
7. Because we can apply the media and treat between the teaching material and the media itself.
  8. The course of teaching media run well and I could easily understand the given assessment
  9. With project-based learning, undergraduate students may explore their creative ideas on their teaching media in order to develop their teaching strategy and transfer the material from teacher to students
  10. Happy, because the teaching was very interesting and not burdening
  11. Happy, because we can produce a product in the form of teaching media that will be useful for us as undergraduate students, and for surroundings as well. Additionally, we can also use our teaching media to join student creativity program for the sake of scholarship.
  12. Happy, because in addition to learning, undergraduate students can figure out ideas and develop those ideas into teaching media that may assist them in teaching.
  13. I am happy because this kind of teaching model encourages us to have teamwork, responsibility, and discipline on the given task. Besides, we can also have more insights about media and improve our skills in constructing media for teaching mathematics.
  14. I am happy, because we can have teamwork between groups through this project-based teaching model. Furthermore, we can easily understand the course of teaching media through t Personally, I am happy with that. This project-based teaching model makes me clearly understand the process of constructing media from the beginning up to the finishing. Besides, this model encourages us to develop our creativity by putting our ideas into concrete objects, like the teaching media.
  15. Because it may improve students active participation in their learning process and thus, developing a project-based teaching model is included in discourse.
  16. Happy, Because through this project-based teaching model, I can have more chance to express and explore my ideas
  17. It develops students' skills and creativity in delivering materials using an interesting media so that the students will neither feel bored nor afraid of mathematics.



18. Because this project-based teaching model for teaching-media discourse gives me weapon for my future teaching profession.
19. Yes, because we can directly understand the course through this project-based model.
20. In my personal opinion, teaching media discourse using project-based teaching model makes me really enjoy the process of learning. We directly practice it, not only theories. Besides, this teaching model gives really huge chance for us to create, generate ideas, and apply them simultaneously.
21. Because undergraduate students can apply their ideas to construct a media into real in this current situation that requires them to learn at home. However, it should not prevent them from developing their creativity.
22. It was fun, developing our creative ideas.
23. his model.

The lecturer expected that those responses could be used as introspection related to what they had done during the process of project-based teaching. The students' responses were listed in Google form as follow.

1. Every respondent (24 undergraduate students) claimed that the lecturer gave a contract of lecturing in the beginning of teaching.
2. Every respondent (24 undergraduate students) claimed that the lecturer explained the given project task they need to construct.
3. Every respondent (24 undergraduate students) claimed that the lecturer allowed them to choose their group by their own way.
4. 87,5% of the respondents claimed that the lecturer gave enough time for them to complete their project.
5. Every respondent (24 undergraduate students) claimed that the lecturer allowed each group to consult their project.
6. Every respondent (24 undergraduate students) claimed that the lecturer allowed each group to present their project result.
7. Every respondent (24 undergraduate students) claimed that the lecturer gave feedback and suggestion toward their group project result.
8. Every respondent (24 undergraduate students) claimed that the lecturer allowed each group to revise their project in accordance to the suggestion and feedback they got in adequate time.

9. Every respondent (24 undergraduate students) claimed that the lecturer assisted and simultaneously did teaching integration by having public service in particular school society.
10. 91,7% of the respondents claimed that the lecturer gave enough time and chance for them to make final report of the project they had constructed.
11. Every respondent (24 undergraduate students) claimed that project-based teaching model is appropriate for teaching-media discourse.

Furthermore, students' responses showed that the lecturer applied project-based teaching model under a set of teaching procedures including a contract of lecturing, the explanation of the given project task, chance to choose group member, consultation, time for completing the media construction and revision, presentation time, up to teaching integration through public service. Additionally, the students' responses also claimed that project-based teaching model made them happy during their learning process as they could explore their creative ideas and do teamwork with others. They could also directly apply the media they had constructed. Undergraduate students would not feel burdened; otherwise, they had an interesting experience through project-based teaching model. Among 24 students, 23 of them gave various brief responses which could be concluded in simpler way that they were happy with that model as they could construct media based on their own creative ideas. Furthermore, they felt happy as they could use their product to join any student creativity programs. Project-based teaching model could be used to explore students' creative ideas, encourage them to do teamwork, and give them chance to directly apply the result of their works. It was consistent with the previous study [9].

## **Conclusion**

Towards the discussion above, it concluded that project-based teaching model implied students' creativity. It could be seen from the result of media construction they made as a given task of teaching-media discourse. Predetermined indicators of creativity which consisted of (1) proficiency, (2) fluency, (3) originality, and (4) detail were useful to reveal students' creativity. Students' proficiency was revealed from the needs analysis on the importance of constructed media for teaching mathematics.

The construction might help students to learn curved-side geometrical objects with abstract elements into concrete ones that

were easy to understand. Fluency was seen from the way they saw on the importance of media in teaching mathematics when it was related to this current covid-19 pandemic era that required students to learn online. Originality was revealed from the touch of technology they used in constructing the media.

They used various indicator lamps which differed from the previous one. Last, detail was clearly seen from how they explained the process of constructing their teaching media. In addition, they could also explain the reason why they chose curved-side geometrical objects as the material of teaching and the utilization of indicator lamps on their media.

## References

- [1] M. Pendidikan, D. A. N. Kebudayaan, and R. Indonesia, "Peraturan Menteri Pendidikan Dan Kebudayaan Nomor 03 Tahun 2020 Tentang Standar Nasional Perguruan Tinggi," 2020.
- [2] M. M. Astriani, "Upaya Mengembangkan Kreativitas Mahasiswa Melalui Pembelajaran Model Project Based Learning," *J. Petik*, vol. 6, no. 1, pp. 36–40, 2020, doi: 10.31980/jpetik.v6i1.738.
- [3] I. W. Anita, "Implementasi Pembelajaran Berbasis Proyek Untuk Menumbuhkan Kemampuan Berpikir Kreatif Matematis Mahasiswa," *J. Penelit. dan Pembelajaran Mat.*, vol. 10, no. 1, pp. 125–131, 2017, doi: 10.30870/jppm.v10i1.1287.
- [4] A. D. Putri, S. Syutaridho, R. Paradesa, and M. W. Afgani, "Peningkatan Kemampuan Komunikasi Matematis Mahasiswa Melalui Inovasi Pembelajaran Berbasis Proyek," *JNPM (Jurnal Nas. Pendidik. Mat.*, vol. 3, no. 1, p. 135, 2019, doi:10.33603/jnpm.v3i1.1884.
- [5] W. S. Hidayati, "Analisis Kreativitas Siswa Dalam Mengimplementasikan Media," no. September, pp. 545–556, 2021.
- [6] E. N. Faulinda and 'Abdu Aghni Rizqi Ni'mal, "Kesiapan Pendidikan Indonesia Menghadapi era society 5.0," *Edcomtech J. Kaji. Teknol. Pendidik.*, vol. 5, no. 1, pp.61–66, 2020.
- [7] N. W. Rati, N. Kusmaryatni, and N. Rediani, "Model Pembelajaran Berbasis Proyek, Kreativitas dan Hasil Belajar Mahasiswa," *JPI J. Pendidik. Indones.*, vol. 6, no. 1, pp.60–71, 2017.
- [8] D. P. Hartono and S. Asiyah, "PjBL untuk Meningkatkan Kreativitas Mahasiswa: Sebuah Kajian Deskriptif tentang Peran Model Pembelajaran PjBL dalam Meningkatkan Kreativitas Mahasiswa," *J. Dosen Univ. PGRI Palembang*, vol. 2, no. 1, pp. 1–

- 11, 2018, [Online]. Available: <https://jurnal.univpgri-palembang.ac.id/index.php/prosiding/index>.
- [9] H. Herwanto, "Meningkatkan Kreativitas Matematika Melalui Model Pembelajaran Project Based Learning Dan Dampaknya Terhadap Sikap Serta Hasil Belajar," JES- MAT (Jurnal Edukasi dan Sains Mat., vol. 2, no. 1, pp. 55-64, 2016, doi:10.25134/jes-mat.v2i1.281.

# **Implementation of E-Learning In Integrated Islamic Junior High School Granada Tangerang City**

Yessi Astriani, Asrori Mukhtarom

## **Introduction**

Almost two years countries in the world including Indonesia were hit by the Covid-19 pandemic. The impact of the crisis from the Covid-19 pandemic changed all sectors of human life including the education sector. As a result of the pandemic, the government made policies related to the implementation of a centralized learning process at home. The policy is based on protecting students from the impact of transmission and spread of Covid-19 which has taken many victims. Responding to the government's policy, of course, educational institutions must be able to improve so that the learning process continues to run following the planned program.

One solution to keep the learning process running in the pandemic period is through the application of E-Learning methods. E-learning is a system or educational concept that utilizes information technology in teaching and learning activities. E-learning is a distance learning process by combines principles in the learning process with technology. The use of e-learning can be an alternative support tool and not as a substitute for education. With the application of e-learning methods, the government hopes that all school institutions can provide the best possible learning in the learning process during the pandemic.

One of the educational institutions that use E-Learning is SMPIT Granada Tangerang City, the school is a Junior High School in Tangerang City with accreditation A. As an integrated Islamic school with a total of 1,035 students, SMPIT Granada has an education system inspired by the success of education in the heyday of Islam. Not only prioritizes faith and piety, but also combines science, technology, and life skills. There is a blend of the national curriculum with an integrated competency-based curriculum and e-learning. With the combination of the curriculum, SMPIT Granada Tangerang city has its characteristics in achieving quality education for the next generation of Islamic personalities with an insightful and comprehensive leadership spirit.

In the current pandemic conditions, schools must be able to provide a dynamic strategy, one of the methods applied by SMPIT Granada Kota Tangerang during the pandemic, namely by using e-

learning methods as a supporting medium in the implementation of school operations, both administrative systems and teaching and learning activities. The E-learning method is a digital learning method that utilizes the internet network and web server as the main infrastructure. So that the teaching and learning process can be done anytime and anywhere by utilizing connections or networks and access to e-learning websites.

This research was conducted at the Integrated Islamic Junior High School (SMPIT) Granada Tangerang City. This research is qualitative research used to examine natural objects. The data collection technique is done in a combined (triangulation), and the resulting data is descriptive and inductive analysis. Reason uses these research methods to help answer how E-Learning implementation at SMPIT Granada Tangerang City.

## **Discussion**

Implementation is the process of laying in practice an idea, program, or set of activities new to others in achieving or expecting a change. [1] According to Mulyadi, implementation refers to actions to achieve the goals set out in a decision. [2] It seeks to turn these decisions into operational patterns and attempts to achieve changes large or small as previously decided.

According to Sukmadinata, e-learning is not only short for electronics, but stands for experience (experience, extended, and expended). [3] Effendi and Hartono explain that e-learning is all activities that use computer media and/or the internet. [4] Chandrawati stated that e-learning is a process of distance learning by combining principles in the learning process with technology. [5] Brown and Feasey also explained that e-learning is a learning activity that utilizes the network (internet, LAN, WAN) as a method of delivery, interaction, and facilities supported by various forms of learning services. [6] In line with Rusman, Kurniawan & Riyana stated that web-based learning is a learning activity that utilizes website media that can be accessed through the internet network. [7] Web-based learning or also known as "web-based learning" is one type of application of e-learning.

Learning using internet technology can provide a lot of information and learning resources and facilities that can support the learning process such as video tutorials, seminars, teaching materials that can be downloaded and uploaded, and even problem tests for evaluation can also be done. [8] Various media used at the time of

online learning can help teachers and students in the teaching and learning process during pandemics. Santoso added that the process of learning online can improve learning achievement. [9] Even Maudiarti added that online learning can be done for everyone, anytime and anywhere by using the attributes and learning resources of digital technology[10]. According to Rosemberg, online learning refers to the use of internet technology to deliver a series of solutions that can improve knowledge and skills[11].

Based on the results of interviews with the principal, in the current pandemic conditions, the headmaster of SMPIT Granada gave directions to teachers to keep learning in school using health protocols. Where the teacher continues to enter the classroom that has been given. The teachers facilitated computers and internet networks in the process of teaching and learning activities. Learning is done by the e-learning method that the teachers do learning in school then students and students follow and listen to the material provided by the teacher through zoom media. Then students collect assignments given by teachers through the Google Classroom app.

From the data sources that researchers do, here is data related to teachers who use e-learning method learning as a design of Islamic Religious Education learning. Six Islamic Religious Education teachers use e-learning methods during pandemic times in particular, and have obtained the following data:

**Tabel1. Teacher Data for Islamic Religious Education E-learning SMPIT Granada Tangerang City**

DATA GURU PEMBELAJARAN E-LEARNING PENDIDIKAN AGAMA ISLAM SMPIT GRANADA KOTA TANGERANG TAHUN AJARAN 2021-2022			
NO	NAMA	GELAR	GURU KELAS
1	Hasanudin Sultoni	S.pd	7A
2	Neng Aprilianti	S.Pd	7B
3	Asmar Yadi	M.pd	8A
4	Srikandi Nur Hanunah	S.Pd	8B
5	Asep Indra Mulyana	S.Pd	9A
6	Nisa Ariviani	S.pd	9B

From the results of the table data above, it can be concluded

that the students and students at SMPIT Granada are divided into two different classrooms, namely class A for women's class and class B for women's class. So that the three levels of classes in SMPIT Granada are seventh, eighth, and ninth grades, then each has a different classroom. We also need a different teacher. Class A is a female class, so Islamic education teachers are female teachers, as well as class B which is a male class, then Islamic education teachers are male teachers.

Several things are supporting factors in the implementation of e-learning methods of Islamic Religious Education in SMP IT Granada students in Tangerang, namely:

1. Competent teacher

The teacher is the first and main media that students need in e-learning learning, although the material presented is already in the package book, the figure of a teacher will still be needed in every learning. Although today many say that teachers only facilitate students, students still need a direct explanation. This is because each student's level of ability is different in understanding the lesson.

2. Technology media

Media is the most important part that teachers and students must have in the e-learning process. The media can be laptops, mobile phones, tablets, and computers. If the media does not exist, then of course learning can not go well.

3. Internet Network

In addition to the media used, the internet network also plays an important role in supporting the process of learning and teaching activities. This internet network can be (Personal Area Network or PAN) such as quota or tethering, then (Home Area Network or HAN) such as wifi, and (Local Area Network or LAN) LAN is a type of internet that uses cable assistance for one building.

4. Signal

After the internet network is adequate, a signal is also one of the things that must exist. A signal is a cross-platform encryption messaging service developed by the Signal Technology Foundation and Signal Messenger (LLC). Aside from these networks, it usually also takes a signal to connect the internet to networks such as E, H +, LTE, 3G, 4G, and 5G. The signal is in the form of a sign, while the network is the flow of data used and is a sign or indicator on the smartphone screen called the signal. Meanwhile, the connection or flow of data connected in a smartphone device is called a network.



5. **Electrical**  
In other respects, electricity is also needed to support the learning process. Of course, if the existing electrical power capacity meets, then the media we use can also run well. Electricity can also facilitate ongoing learning activities. If the existing electrical power capacity is less, it will be a problem for the continuity of the teaching and learning process.
6. **School Permission**  
Permission from the school is very important and the school also requires e-learning activities can run well. Because permission from the school is a very important factor that can facilitate the learning process online.
7. **Flexible**  
E-learning is one of the learning processes that can be done at any time with a flexible time. In some conditions, students can collect assignments with agreed time through the media used. So that students can collect assignments in the morning, afternoon, or even night.
8. **Family**  
Family is a reason that will always be there in every process of children's development, especially in the learning process in school. So in the current condition, support and spirit on the part of the family is an important role in the achievement of children's education.

From some of the above factors, it can be concluded that the supporting factor in the implementation of Islamic religious education e-learning methods in SMPIT Granada students is an effort that must be improved and concerned for all, especially teachers and parents. Where only with an increase in supporting factors can students follow the learning well and get an education by their rights.

## **Conclusion**

The e-learning method is one form of alternative learning by using media and internet networks as interactive learning that develops an active, independent, and creative attitude. Learning using e-learning methods can be accessed easily and anytime, more flexible and dynamic time, using supporting media, networks, electricity, and quotas. But the obstacles that often occur in e-learning are network instability and lack of knowledge about information technology and technology for educators or learners.

Implementation of Islamic Education e-learning method in it

junior high school students Granada Tangerang city is using media and internet network in the form of Virtual Zoom application, Google Meet, Google Class Room, Google Form, and WhatsApp as a support for e-learning system during the covid-19 pandemic.

## References

- [1] A. Majid, *Strategi Pembelajaran*. Bandung. PT Remaja Rosdakarya, 2014.
- [2] Mulyadi, *Perilaku Organisasi dan Kepemimpinan Pelayanan*. Bandung: Alfabeta, 2015.
- [3] Sukmadinata, *Metode penelitian Pendidikan*. Bandung: Remaja Rosdakarya, 2012.
- [4] E. Effendi and H. Zhuang, *E-Learning Konsep dan Aplikasinya*. Yogyakarta: Andi, 2005.
- [5] Chandrawati, S. R, "Pemanfaatan E-learning dalam Pembelajaran", *J. Cakrawala Kependidikan*, 8 (2), pp. 1-10, 2010.
- [6] Darmawan, *Pendidikan Teknologi Informasi dan Komunikasi*. Bandung: PT Remaja Rosdakarya, 2012.
- [7] Rusman, *et al*, *Pembelajaran Berbasis Teknologi Informasi dan Komunikasi*. Jakarta: PT Rajagrafindo Persada, 2011.
- [8] S. Siahaan, "Pemanfaatan Teknologi Informasi dan Komunikasi (TIK) Untuk Pembelajaran: Sebuah Kajian", *J. Teknodik*, Vol. 18 - Nomor 3, pp. 276-277, 2014.
- [9] Santoso, *Dinamika Kelompok*. Jakarta: Bumi Aksara, 2009.
- [10] Sant. Maudiarti, "Penerapan E-Learning di Perguruan Tinggi", *J. PERSPEKTIF Ilmu Pendidikan*, Vol. 32 No.1, pp. 57, 2018.
- [11] Rosenberg, Marc. J.E, *Learning : Strategies For Delivering Knowledge In The Digital Age* . USA : McGraw-Hill Companies, 2001.

# **Bibliometric Analysis Of Digital Marketing And Halal Cosmetics**

Yulist Rima Fiandari

## **Introduction**

Awareness of the use of halal products among Muslims is growing. The halal industry in the tourism sector to halal cosmetics has an economic potential value of 2.1 trillion dollars per year [1]. Halal cosmetics can be seen easily with a halal certificate that has been owned by a cosmetic [2]. Halal cosmetic marketing was initially through direct marketing through stores to consumers. Product marketing developments have shifted through online marketing. The development of halal cosmetic marketing has grown not only done directly but also through online marketing. Online marketing that has not been developed optimally has stirred researchers to do development. This research is aimed at knowing the development of halal cosmetic marketing research through digital marketing. Research is done using bibliometric analysis.

Bibliometric analysis is done to see the development of research on a topic. Bibliometric analysis focuses on sources derived from journals [3]. Bibliometric analysis is done by determining the intended target, grouping the target and analyzing the results obtained to make meaningful meanings [4]. Bibliometric analysis is a rigorous and systematic analysis by identifying qualitative and quantitative changes in research topics.

The study was conducted by collecting data using publish or perish. Publish or perish data source from google scholar. The keywords used in the study were "Halal Cosmetics" and "Digital Marketing". Publish or perish can summarize data on the number of citations, author data, year of publication, source, publisher, related article links, volume, abstract and other data. The data obtained also showed the impact factor of the journal [3]. The data selected came from the last 5 years, which started from 2016 to 2021. The results showed preliminary data collected as many as 60 journals. Researchers select selected the selected data and performed key word co occurrence analysis using the VOSviewer approach [6], [7]. VOSviewer software is able to present relationships between data with a good visual display that supports the data analysis process. The results of the study can be seen in the form of network visualization, overlay visualization and density visualization [8].

## Discussion

### Number of publications and citations in articles

The publication of scientific articles in 2016 - 2021 about showing a development that tends to increase every year. Table 1 and Figure 1 show the number of articles published in 2021 showing the largest number of 27 articles (45%) followed by article publication in 2016 - 2020 as many as 2, 6, 10, and 15 articles. The number of citations obtained tends to indicate a greater number than the number of articles published in the same year.

**Table 1. Number of publications article and citations**

Year	Article	Percentage (%)	Citation	Percentage (%)
2016	2	3.33%	7	5.74%
2018	6	10.00%	9	7.38%
2019	10	16.67%	27	22.13%
2020	15	25.00%	56	45.90%
2021	27	45.00%	23	18.85%
Total	60	100.00%	122	100.00%

This can be seen in the number of articles and citations in 2016 showing 2 articles with the number of citations as many as 7 to 2020 shows the number of articles as many as 15 articles with 56 citations. Data in 2021 shows the number of articles as many as 27 articles with 23 citations. The highest number of citations in articles in 2020 was 56 (45.90%) compared to 2016 - 2019 and citations in 2021. The results of citations have an opportunity to increase in the year of observation, namely in 2016 and 2021. Large citations show research to be a source of reference for other research.

### Article Development and citation sources

The article that had the highest citation in Table 2 of the most citationd articles was obtained by [1] under the title "Determinants of purchase intention of halal cosmetic products among Generation Y consumers" with the number of citations as many as 19 from the Journal of Islamic Marketing. The research revealed that there are positioning constraints on halal cosmetics so that identification of factors that influence consumers to make purchasing decisions in generation Y in Malaysia is needed. The findings of the study show the safety of cosmetic raw materials as well as halal logos on cosmetic

products have an important role for consumers in making purchasing decisions.

The next article has 13 citations with the title "Halal Industry in Indonesia; Challenges and Opportunities" written by [2] published by the Journal of Digital Marketing and Halal Industry. That journal report the potential of halal industry in Indonesia including food and beverage sector, tourism, fashion, medicine and cosmetics.

Optimization of synergy between the community, government, academics, industry players and related parties so that the halal industry in Indonesia has increased significantly. The article has the same number of citations as 13 with the title "Intention to purchase halal cosmetics: do males and females differ? A multigroup analysis" published by the journal Cosmetics. The article written by Ngah et al.2021) is based on the tendency of millennial youth attitudes to choose international cosmetics that are not yet halal. The study was conducted on both men and women. The results showed subjective norms had a stronger influence on women, while behavioral control had a more dominant role in men. Brand attitudes and imagery have a positive influence on cosmetic purchase intentions in both men and women.

**Table 2. Rank of Citation Article**

Rank	Citation	Title	Author and year of publication	Source
1	19	Determinants of purchase intention of halal cosmetic products among Generation Y consumers	Khan <i>et al.</i> (2021)	Journal of Islamic Marketing
2	13	Halal Industry in Indonesia; Challenges and Opportunities	Mubarok & Imam (2020)	Journal of Digital Marketing and Halal Industry
3	13	Intention to purchase halal cosmetics: do males and females differ? A multigroup analysis	Ngah <i>et al.</i> 2021)	Cosmetics
4	12	Purchase behavior of millennial female	Handriana <i>et al.</i> (2021)	Journal of Islamic

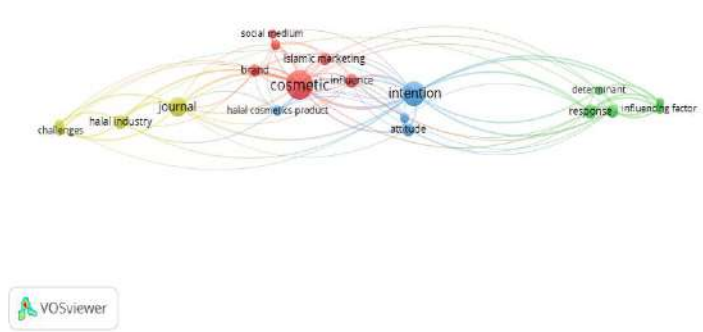
Rank	Citation	Title	Author and year of publication	Source
5	7	generation on Halal cosmetic products Health and beauty cosmeceuticals industry and market expansion in Saudi Arabia	Tambo <i>et al.</i> (2016)	Marketing Pharmaceutical Regulatory Affairs
6	7	Response to a New Wave in Digital marketing: Does beauty blogger involvement the most influencing factor in halal cosmetic purchase intention	Putri & Abdinagoro (2018)	International Journal of Supply Chain Management
7	6	Factors affecting consumers' loyalty towards halal cosmetics: an emerging market perspective	Sama & Trivedi, (2019)	International Journal of Business and Emerging Markets
8	6	Halal Label vs Product Quality in Halal Cosmetic Purchasing Decisions	Anggadwita <i>et al.</i> (2020)	IKONOMIKA
9	4	The role of religiosity on halal product purchasing decision case study: Wardah cosmetics	Amalia, (2020)	Journal of Digital Marketing and Halal Industry
10	4	The Personal is Political: Gendered Morality in Indonesia's Halal Consumerism	Rakhmani (2019)	Library Philosophy and Practice

Optimization of synergy between the community, government, academics, industry players and related parties so that the halal industry in Indonesia has increased significantly. The article has the same number of citations as 13 with the title "Intention to purchase halal cosmetics: do males and females differ? A multigroup analysis" published by the journal *Cosmetics*. The article written by

[3]. Research based on the tendency of millennial youth attitudes to choose international cosmetics that are not yet halal. The study was conducted on both men and women. The results showed subjective norms had a stronger influence on women, while behavioral control had a more dominant role in men. Brand attitudes and imagery have a positive influence on cosmetic purchase intentions in both men and women.

**Co occurrence Relationship**

The data shown by Figure 1 shows the relationship between words. The largest node indicates the most dominant word. Occurrence data from the title overview and abstract followed by the fullcounting option with a minimum occurrence number at value 4. This method in Data Extraction results is also shown in Figure 1. The data shown in Table 3 obtained 4 clusters. Cluster 1 is dominated by occurrence cosmetics that have relevance to digital marketing strategy and Islamic marketing. Cluster 2 is dominated by response, influencing factors and new wave. Cluster 3 is dominated by intention while cluster 4 is dominated by journals and halal industry.



**Figure 1 Network Visualization Occurence**

The occurrence value in cluster 1 suggests research on cosmetics has been widely done. Research on cosmetics has a relationship with influencing factors. The development of research has used digital marketing strategy that is translated into a digital marketing strategy. Digital marketing strategies have an important role to play. Digital marketing strategies increase the brand's

awareness of cosmetic products. Optimization can be done by increasing promotions using social media such as YouTube and Instagram [19]. Muslim consumers pay attention to the page on the product to be used. Halal is the standard of a product that can be used or consumed by a Muslim. This is clearly written in the Qur'an. Cluster 2 shows the new wave in digital marketing both domestically and abroad. One of the activities carried out is the involvement of beauty bloggers in promotional activities. Digital marketing is becoming a new phenomenon. Beauty blogger engagement has a role for cosmetic brands because reviews presented by beauty bloggers provide important product information such as the suitability of product use for consumers [20]. The information provided by beauty bloggers reinforces the formation of attitudes for consumers. The response also attracted the intention of millennials, especially to try. This indicates a relationship with cluster 3. Beauty bloggers have also reviewed halal cosmetic products. Reviews provided become a reference for consumers to use the product. Reviews of halal cosmetic products can shape consumer intentions of purchasing halal cosmetics [13]; [21]. Religiosity has an influence on consumers in purchasing halal cosmetics. Religiosity is a commitment to implement actions based on religious teachings in everyday life. It takes emotional attachments and quality products to encourage consumers to make repeat purchases. [22]. The occurrence data in cluster 3 has a relationship with cluster 4. The purchase of halal cosmetics that has not been optimal is a challenge for the halal industry. Halal cosmetics have differences with cosmetics that do not yet have halal certification. Halal cosmetics come from halal raw materials. The process of making halal cosmetics follows manufacturing requirements procedures and has halal guarantee during the manufacturing process.

The purchase of halal cosmetics that has not been optimal is a challenge for the halal industry. Halal cosmetics have differences with cosmetics that do not yet have halal certification. Halal cosmetics come from halal raw materials. The process of making halal cosmetics follows manufacturing procedures and has halal jams during the manufacturing process. Halal processes and raw materials are needed to produce halal cosmetic products in accordance with the standards of halal regulatory institutions such as LPPOM-MUI, JAKIM. Documentation of the production process until the delivery of the final product is required to straighten out each production system process [23]. [24]. Indonesia has a predominantly Muslim population, so the



opportunity for the halal industry to improve quality halal cosmetics according to consumer needs.

## Conclusion

The development of scientific article publications shows that the number of articles and citations tends to increase every year. Different results were shown in 2021 the number of articles and citations was lower than the previous year. Research has been conducted focusing on the intention of using halal cosmetics among young people. Research on halal cosmetics shows the role of beauty bloggers in digital marketing. This is a new thing that has not been developed much in digital marketing. The results showed that the number of article and citations is still limited so that it has the potential to be developed further which can provide a role for the industrial world, especially the halal industry in Indonesia. The development of the halal industry is expected to increase the role of the halal industry at the global level. Active cooperation between academics and practitioners is needed to produce synergies that provide sustainable progress in the halal industry in Indonesia.

## References

- [1] E. Izberk-Bilgin and C. C. Nakata, "A new look at faith-based marketing: The global halal market," *Bus. Horiz.*, vol. 59, no. 3, pp. 285–292, 2016, doi: <https://doi.org/10.1016/j.bushor.2016.01.005>.
- [2] C. A. Annabi and O. O. Ibidapo-Obe, "Halal certification organizations in the United Kingdom," *J. Islam. Mark.*, vol. 8, no. 1, pp. 107–126, Jan. 2017, doi: 10.1108/JIMA-06-2015-0045.
- [3] C. Michael H., "Publish and perish? Bibliometric analysis, journal ranking and the assessment of research quality in tourism," *Tour. Manag.*, vol. 32, no. 1, pp. 16–27, 2011, doi: <https://doi.org/10.1016/j.tourman.2010.07.001>.
- [4] Y. R. Leong, F. P. Tajudeen, and W. C. Yeong, "Bibliometric and content analysis of the internet of things research: a social science perspective," *Online Inf. Rev.*, vol. 45, no. 6, pp. 1148–1166, 2021, doi: 10.1108/OIR-08-2020-0358.
- [5] G. Misra, V. Kumar, A. Agarwal, and K. Agarwal, "Internet of Things (IoT) – A Technological Analysis and Survey on Vision, Concepts, Challenges, Innovation Directions, Technologies, and Applications (An Upcoming or Future Generation Computer Communication System Technology)," *Am. J. Electr. Electron. Eng.*

- Vol. 4, 2016, Pages 23-32*, vol. 4, no. 1, pp. 23–32, 2016, doi: 10.12691/ajeee-4-1-4.
- [6] L. Xie, Z. Chen, H. Wang, C. Zheng, and J. Jiang, “Bibliometric and Visualized Analysis of Scientific Publications on Atlantoaxial Spine Surgery Based on Web of Science and VOSviewer,” *World Neurosurg.*, vol. 137, pp. 435-442.e4, 2020, doi: <https://doi.org/10.1016/j.wneu.2020.01.171>.
- [7] R. Katoch, “IoT research in supply chain management and logistics: A bibliometric analysis using vosviewer software,” *Mater. Today Proc.*, 2021, doi: <https://doi.org/10.1016/j.matpr.2021.08.272>.
- [8] O. Pasin and T. Pasin, “Bibliometric Analysis of COVID-19 and the Association With the Number of Total Cases,” *Disaster Med. Public Health Prep.*, pp. 1–6, 2021, doi: DOI: 10.1017/dmp.2021.177.
- [9] N. Khan, A. Sarwar, and B. C. Tan, “Determinants of purchase intention of cosmetic products among Generation Y consumers,” *J. Islam. Mark.*, vol. 12, no. 8, pp. 1461–1476, Jan. 2021, doi: 10.1108/JIMA-11-2019-0248.
- [10] F. K. Mubarok and M. K. Imam, “Halal Industry in Indonesia; Challenges and Opportunities,” *J. Digit. Mark. Halal Ind. Vol 2, No 1*, 2020, doi: 10.21580/jdmhi.2020.2.1.5856.
- [11] A. H. Ngah, S. Gabarre, H. Han, S. Rahi, J. A. Al-Gasawneh, and S. Park, “Intention to Purchase Halal Cosmetics: Do Males and Females Differ? A Multigroup Analysis,” *Cosmetics* , vol. 8, no. 1. 2021, doi: 10.3390/cosmetics8010019.
- [12] E. Tambo, A. H, and Y. A, “Health and Beauty Cosmeceuticals Industry and Market Expansion in Saudi Arabia,” *Pharm. Regul. Aff.*, vol. 5, May 2016, doi: 10.4172/2167-7689.1000172.
- [13] T. U. Putri and S. B. Abdinagoro, “Response to a New Wave in Digital marketing: Does beauty blogger involvement the most influencing factor in halal cosmetic purchase intention,” *Int. J. Supply Chain Manag.*, vol. 7, no. 6, pp. 446–452, 2018.
- [14] R. Sama and J. P. Trivedi, “Factors affecting consumers’ loyalty towards halal cosmetics: an emerging market perspective,” *Int. J. Bus. Emerg. Mark.*, vol. 11, no. 3, pp. 254–273, Jan. 2019, doi: 10.1504/IJBEM.2019.102655.
- [15] G. Anggadwita, D. T. Alamanda, and V. Ramadani, “Halal Label vs Product Quality in Halal Cosmetic Purchasing Decisions,” *Ikonomika*, vol. 4, no. 2, pp. 227–242, 2020, doi: 10.24042/febi.v4i2.5897.
- [16] F. Amalia, “The Role of Religiosity on Halal Product Purchasing

- Decision Case Study : Wardah Cosmetics,” *J. Digit. Mark. Halal Ind.*, vol. 1, no. 1, p. 19, 2020, doi: 10.21580/jdmhi.2019.1.1.4774.
- [17] I. Rakhmani, “The Personal is Political: Gendered Morality in Indonesia’s Halal Consumerism,” *TRaNS Trans -Regional - National Stud. Southeast Asia*, vol. 7, no. 2, pp. 291–312, 2019, doi: DOI: 10.1017/trn.2019.2.
- [18] T. Handriana *et al.*, “Purchase behavior of millennial female generation on cosmetic products,” *J. Islam. Mark.*, vol. 12, no. 7, pp. 1295–1315, Jan. 2021, doi: 10.1108/JIMA-11-2019-0235.
- [19] L. W. Evelina and Y. Safitri, “Customer Experience Bali Natural Beauty Care Through Social Media,” in *2019 International Conference on Information Management and Technology (ICIMTech)*, 2019, vol. 1, pp. 82–86, doi: 10.1109/ICIMTech.2019.8843757.
- [20] F. O. Fatmi, A. N. Ahmad, and B. Kartika, “Determinants affecting purchase intention of halal products: an article review,” *J. Halal Prod. Res.*, vol. 3, no. 2, p. 63, 2020, doi: 10.20473/jhpr.vol3-issue.2.63-79.
- [21] M. F. Wajdi, H. M. Aji, and S. Muhammad, “Factors affecting the intention to purchase halal cosmetics on Instagram: E-WOM and brand image,” *Asian J. Islam. Manag.*, vol. 2, no. 1, pp. 1–11, 2020, doi: 10.20885/ajim.vol2.iss1.art1.
- [22] D. Suhartanto, D. Dean, I. S. Sarah, R. Hapsari, F. A. Amalia, and T. Suhaeni, “Does religiosity matter for customer loyalty? Evidence from halal cosmetics,” *J. Islam. Mark.*, vol. 12, no. 8, pp. 1521–1534, Jan. 2021, doi: 10.1108/JIMA-03-2020-0069.
- [23] K. Sugibayashi *et al.*, “Halal cosmetics: A review on ingredients, production, and testing methods,” *Cosmetics*, vol. 6, no. 3, pp. 1–17, 2019, doi: 10.3390/cosmetics6030037.
- [24] M. Divianjella, I. Muslichah, and Z. H. A. Ariff, “Do religiosity and knowledge affect the attitude and intention to use halal cosmetic products? evidence from Indonesia,” *Asian J. Islam. Manag.*, vol. 2, no. 2, pp. 71–81, 2020, doi: 10.20885/ajim.vol2.iss2.art1.

# The challenge of building critical thinking in Era 5.0

Zahara Tussoleha Rony<sup>121</sup>

## Introduction

The trends of life are filled with various dynamics of new styles. Unconsciously the established become obsolete, even the arrival of new things has never been predicted before. People change easily trends feel unsuitable and do not even want to use old trends. They want to be different and change the way they think, how they work, cultured ways, and then form a new lifestyle. They proudly show all things new despite the forced efforts of force: "Those who are not adaptive to the new lifestyle must shift aside" covering, enjoying his conventional style, while a new phenomenon unfolds around him, just looking on, silently stunned and standing in a corner with a *"marginalized psychological feeling"* [1].

Mark Zuckerberg as the founder of Facebook reminds that the world has undergone a change [2]. The face and appearance of the world is a new face because humans are and live in an environment where information becomes a new commodity. In other words, information has changed the way of life. Changing the way of life both in cities and villages. Changing the way ordinary people think and the elite. Today, information becomes an institution that can manage the world. An institution which stands without an obscure rule and system. The presence of information gives a pattern of people's lives and world order of life, determining the direction and even controlling the world. Information can bring each other closer, distant becomes close, near becomes open. Without realizing it, world life is present in the human behavior system. Human can capture any information from anywhere. Have direct access and connect to the world's living order. We immediately become citizens of the world.

The new order is constantly coming with exponential movements. Often, the old order meets the new order. Often the touch does not last softly, sometimes the touch lasts hard even occasionally has a collision, breaks the old one, crushes it into pieces without any leftovers and becomes a memory. That's why readiness to face disruption must be the awareness of all of us, so that we are not too surprised when we see the world around us rapidly changed, we do not necessarily feel strange ourselves. It's a fact we live with.

---

<sup>121</sup> University of Bhayangkara Jakarta Raya

The above phenomenon describes major changes in the order of life and automatically demands changes in the world of education and industry. In the rapidly evolving era of technology, information, and communication, the demands of information literacy skills are increasingly important and required. The sheer amount of information available in various forms requires skilled individuals to choose and use information effectively [3]. With the ability to literacy information and critical thinking, individuals can determine that the information obtained is truly important information, whether information is needed, and can be utilized, especially can add horizons of knowledge. Individuals are expected to be able to adapt to new systems of thinking. The system of thinking may be different from the one we embrace. New systems of thinking are blended through a variety of information, diverse perspectives, variety of values and diverse interests. [4] The thinking system requires an integrated skill.

Grouping thinking skills is one of the life skills of the 21st century [5]. Skills often called 21st century skills consist of 6 C; Computational Thinking, Creative, Critical thinking, Collaboration, Communication, and Compassion. Several organizations have formulated definitions of 21st century skills. Of all the definitions formulated by several organizations, all have almost the same essence. Recognizing the importance of 6 C proficiency for each individual, the government through direct messaging and webinars and face-to-face establishing 21st century skills must be taught in schools [6]. Industry practitioners through seminars are also no less great calling for that 6C skills are highly considered and needed in the world of work. Although this article has been reviewed quite often with other interesting themes, but in this article the author wants to explain how important critical thinking skills are, how we are able to become individuals who continue to learn to build responsible information literacy and critical thinking. The author's hopes, this paper provides additional insight, knowledge as well as high awareness for individuals who have a role as parents and educators.

## **Discussion**

In the 21st century information exists in time. Not yet lost old information, new knowledge information present. Suddenly came hoax knowledge information accompanied by mixed knowledge, not too clear the truth and presented unfiltered in front of us. We need to carefully select, which information of knowledge is true. We become the last key to stating and determining which information is reliable,

true, and accurate. Therefore we need to determine attitudes, which information is useful and can be utilized to drive our own progress. We become the vanguard for ourselves who unravel, select all the supplies of that information, so that the information is useful for our lives. We are the one who enforce ethics for ourselves although sometimes, the invasion of information gives rise to what is referred to as "quantum information" [7]. Information that comes and comes before us that goes beyond our needs. Information that spills out everywhere. Information which encourages people to be chaotic. Information which no longer pays attention to the dose. It is supplied massively and applies universally, to the public, without discrimination between the receivers [8].

This kind of information, really, forces people to behave or act "jumping up and down". Jumping his way of thinking. Jump how to deal with it. Jumping figs judged it. Jumping the way it responds, so people tend to lead to a well-informed situation. We fail to be reasonable in our information. We are wrong in assessing information. We're stuck in misinformation. The rush of information supply can lead to the development of information in the community. This condition can encourage chaos during the lives of the wider community. Chaos because there is a mass information in society. When this situation occurs in our lives, we are in an unbelievable information system. Therefore, individuals should ideally be able to adapt to the rush of diversity of new ways and "engage" in "a new system thinking". Without such abilities, the rush of information would give rise to "a distraction of mentality". It is certain that we do not want to include individuals who include psychological confusion in responding to various information presented simultaneously at the same time.

### **So, what's important for us to pay attention to?**

A society 5.0 concept which was initiated and coveted by the Japanese government can be a basic reference, the concept emphasizes efforts to put humans at the center of innovation [9]. Humans as thinking creatures are very possible to use artificial intelligence-based science and the internet of things. The presence of technology accompanied by the ability to do information literacy and ethical critical thinking is expected to create innovation and a dignified modern civilization. [10] Era society 5.0, It puts people as the main component in it, not just as passive component just like in the industrial revolution 4.0." In society 5.0, people are required to more

quickly produce solutions to meet their needs. This has an impact on humans to continue to dig up information and create new innovations to support their survival. The concept of Era 5.0 encourages all generations to do growth mindset, especially in the post-Millennials generation who need to prepare to penetrate into the world of work with various character values which need to be developed and must be fostered in line with the development of appropriate competencies and needed in Era 5.0 including higher order thinking skills (HOTS). This becomes important because the ability to think critically is an essential core life skills [11]. Critical thinking is different from argumentative which often just throws arguments and leads to long, endless debates. A person's success in acting on critical thinking depends on many factors including managing emotional intelligence. An integrative review of the literature shows that emotional intelligence and critical thinking are interdependent [12].

Emotional intelligence is defined as "the ability to control the emotions of oneself and others." Emotional intelligence is necessary in guiding one's thoughts and actions in managing information [13]. Many studies have shown that emotional intelligence has a significant effect on critical thinking, creativity, academic success, mental health, and cognitive-based performance [14], [15]. Affirmed by Goleman, an expert on emotional quotient (EQ) that emotions and thoughts are interconnected with each other [16]. In addition, research conducted by [15] showed that people with higher emotional intelligence can process emotional information more efficiently and automatically, and always demonstrate high levels of critical thinking skills. Therefore "a distraction of mentality", can be avoided when someone has a good EQ, we can use information and process information responsibly. Where does information come from, who provides information, whether information provides benefits.

### **Where do we start building critical thinking competencies?**

Schools and educational institutions should be one of the containers for a child to get a foundation and process getting something unknown before through the learning process. It can be started from basic knowledge such as mathematics, natural sciences, social sciences, languages and various another knowledge. In school, children can be taught to seek, use reason and mind to keep thinking [17]. However, the problem that arises is precisely the child's curiosity is sometimes unconsciously limited by teachers and parents themselves. It can be said, to build children's ability to think to be

constrained when teachers and parents do not want to understand the importance of building critical thinking competencies early on, even though these abilities are very important for them to be independent and collaborate throughout their lives.

Without realizing it, parents often softly kill their curiosity by reason questions and actions of children trouble parents. Even in this era, parents easily silence and ask children to look for answers all on google without the process of assistance. At the launch of the Kalbe Junior Scientist Award [18] April 2021, in Jakarta, Soedjatmiko, a specialist in child development, said that children need to be given freedom as long as they do not harm others and themselves or violate ethics and morals. Children need to be encouraged to explore their ability to cultivate their self-confidence [19]. And it needs to be done as early as possible. Not waiting for the teenage years. Instead, if it is too late, the child's confidence is more difficult to develop. In addition to family, teachers in schools are the main support to build a pleasant learning atmosphere and encourage children to explore their knowledge widely.

Mal Leicester and Denise Taylor [20] explain some aspects that need to be considered in building children's critical thinking skills developed from Brookfield [21] namely 1) Asking is one of the habituation developed, in this aspect a child forms his own opinion and builds his own thinking. 2) Analysing, where a child must learn to evaluate the evidence and assess how beliefs must be maintained. 3) Being rational, children are required to give reasons for the viewpoints they believe in while also accepting the differences in the viewpoints of others with different backgrounds of experience and reasons. 4) Finding out basically asking is one way to find out. Children are accustomed to ranging from simple facts to more complex facts. 5) Analysis is divided into three parts, namely conceptual analysis, meta-analysis, and categorization & comparison.

Giving an understanding that what is right, is not as easy as to turn over the palm of our hand. Because what we hear or what we see is not necessarily true. Humans are creatures which cannot be separated from mistakes, the issue of right and wrong can be subjective view. However, if children are always limited because of subjective knowledge and are not allowed to imagine deeper about science. Then as adults, we have limited the function of the human mind which is very extraordinary. Being adult person, it doesn't mean we become individual who are always right, adults only live in this world prior to their children. They have more life experiences than



children, but that does not mean that their life experiences will be the same as those of their children. So that, we should not taboo to be criticized, and always feels right. Giving an understanding of good and bad and willing to admit mistakes in front of children is the highest form of education. Because of that, children will understand that humans are unique, humans are different, humans can be wrong and right. Dictatorship in education and family is terrible because it will form a child who is timid and insecure to develop. It will even become an individualist child who is not sensitive to the surrounding environment.

In critical thinking, sensitivity to the environment is very important as a trigger in creating crazy and unthinkable ideas and thoughts. Let children not to be limited in thinking [22]. Questioned what he had doubts about, said what he wanted to say. We as adults only give knowledge of what we know, about good and bad, about the consequences, about the responsibility he must bear if he chooses something. Activities that are prepared for children or those that are passed by children must be activities that facilitate critical thinking skills Daloz, 1986 in Brookfield [21]. Activities that make them able to become confident individuals, synergize so that they will give birth to many useful innovations in society.

We should think about breaking and scolding them just for not agreeing with what they said. The learning gained at school is not enough to be a provision for the experiences that children experience from seeing, hearing, and being felt. Children are not inanimate objects, they are human beings who have reason to think, have different ways and perspectives in seeing a problem. Every child has different desires, desires, and strengths. Do not let us compare something that is clearly different. If it refers to the greatness of God. He created humans with different human faces and fingerprints even though there are so many humans. Humans are unique and different from one another. Don't we believe that every human being is given different potential and greatness?

## **Conclusion**

The Era 5.0 concept encourages all generations to adopt a growth mindset, especially the post-Millennials generation to become innovative people who use technology as a tool to produce a world with a new face. The impact of information and communication technology has brought fundamental changes, especially the quality of information material and the wider range of information. The ability

to build critical thinking is a must, therefore it is necessary a continuous and consistent formation process with the support of the family environment and educators. The government as a policy maker must be involved and in fact has high hopes for the formation of Indonesian people who are able to think critically because critical thinking as one of the life skills is needed by an individual.

## References

- [1] P. Kennedy, "Working with Physically Disabled People," in *What Is Clinical Psychology*, New York: Oxford University Press, 1999, pp. 134–156.
- [2] F. Newsroom, "Founder Bios," *Facebook*, 2017. <http://newsroom.fb.com/founder-bios/> (accessed Nov. 10, 2021).
- [3] N. Bowles, C. Mackintosh, and A. Torn, "Nurses' communication skills: an evaluation of the impact of solution-focused communication training," *J Adv Nurs*, vol. 36, no. 3, pp. 347–354, 2001.
- [4] G. Midgley, "Systems thinking for evaluation," in *Systems concepts in evaluation: An expert anthology*, Point Reyes, CA: Edge Press, 2007, pp. 11–34.
- [5] L. M. Greenstein, *Assessing 21st century skills: A guide to evaluating mastery and authentic learning*. Thousand Oaks, CA: SAGE Publications Ltd, 2012.
- [6] E. Y. Wijaya, D. A. Sudjimat, and A. Nyoto, "TRANSFORMASI PENDIDIKAN ABAD 21 SEBAGAI TUNTUTAN PENGEMBANGAN SUMBER DAYA MANUSIA DI ERA GLOBAL," *Pros. Semin. Nas. Pendidik Mat.*, vol. 1, pp. 263–278, 2016.
- [7] M. A. Nielsen and I. L. Chuang, *Quantum Computation and Quantum Information*. Cambridge: Cambridge University Press, 2000.
- [8] S. Fortin, O. Lombardi, and L. Vanni, "A Pluralist View about Information," *Philos. Sci.*, vol. 82, no. 5, 2014.
- [9] Usmaedi, "EDUCATION CURRICULUM FOR SOCIETY 5.0 IN THE NEXT DECADE," *J. Pendidik. Dasar Setiabudhi*, vol. 4, no. 2, 2021.
- [10] Suherman, Musnaini, H. Wijoyo, and I. Indrawan, *Industry 4.0 vs Society 5.0*. Banyumas: Pena Persada, 2020.
- [11] G. F. Smith, "Thinking Skills: The Question of Generality," *J. Curric. Stud.*, vol. 34, no. 6, pp. 659–678, 2002.
- [12] K. Christianson, "Emotional Intelligence and Critical Thinking in Nursing Students," *Nurse Educ.*, vol. 45, no. 6, pp. E62–E65, 2020.

- [13] J. D. Mayer, D. R. Caruso, and P. Salovey, "The Ability Model of Emotional Intelligence: Principles and Updates," *Emot. Rev.*, vol. 8, no. 4, pp. 290–300, Oct. 2016, doi: 10.1177/1754073916639667.
- [14] A. Ruiz-Ariza, S. Suárez-Manzano, S. López-Serrano, and E. J. Martínez-López, "The effect of cooperative high-intensity interval training on creativity and emotional intelligence in secondary school: A randomised controlled trial," *Eur. Phys. Educ. Rev.*, vol. 25, no. 2, pp. 355–373, May 2019, doi: 10.1177/1356336X17739271.
- [15] B. Yao *et al.*, "Active N6-Methyladenine Demethylation by DMAD Regulates Gene Expression by Coordinating with Polycomb Protein in Neurons," *Mol. Cell*, vol. 71, no. 5, pp. 848–857, 2018.
- [16] D. Goleman, *Kecerdasan Emosional: Mengapa EI lebih penting daripada IQ*. Jakarta: PT. Gramedia Pustaka Utama, 2009.
- [17] R. A. A. Wattimena, "PENDIDIKAN FILSAFAT UNTUK ANAK? PENDASARAN, PENERAPAN DAN REFLEKSI KRITIS UNTUK KONTEKS INDONESIA," *J. Filsafat*, vol. 26, no. 2, p. 163, Aug. 2016, doi: 10.22146/jf.12782.
- [18] KJSA, "Kalbe Junior Science Award," *Kalbe*, 2021. <https://www.kalbe.co.id/news-and-events/ArtMID/443/ArticleID/1003/THESE-ARE-THE-SCIENCE-PROJECTS-OF-THE-WINNERS-OF-KALBE-JUNIOR-SCIENCE-AWARD-KJSA-2021> (accessed Nov. 20, 2021).
- [19] W. Schneider, "Performance prediction in young children: Effects of skill, metacognition and wishful thinking," *Dev. Sci.*, vol. 1, pp. 291–297, 1998.
- [20] Leicester and Taylor, *Critical Thinking Across The Curriculum: Developing critical thinking skills, literacy, and philosophy in the primary classroom*. England: Open University Press, 2010.
- [21] S. D. Brookfield, *Developing Critical Thinkers*. USA: Open University Press, 1987.
- [22] S. Grover, D. Pick, S. Teo, M. Roche, and C. Newton, "Psychological Capital As a Personal Resources in the JD-R Model," *Pers. Rev.*, pp. 968–984, 2015.

# Creative Industries in The New Normal Era: The Role of Digital Marketing

Zakiah Zahara<sup>122</sup>, Muslimin<sup>123</sup>

## Introduction

The digital environment has profound implications for the creative industry in every sense and requires dramatic changes across the the entire value chain, including business models, stakeholder relationships, and intellectual property management [1]-[3]. The creative industry is driving economic growth around the world, opening up new conceptual frameworks and inspiring businesses and organizations to meet the needs of a society dominated by rapidly changing innovations [4], [5]. Creativity and culture are two component of the global study in this study on economic activity [6]. Until recently, the term "creative area" was rarely used. Significant changes in business are becoming more important to the company. Well-known growth drivers in the creative industries are among other things, the emergence of the B + R industry, the intellectual change in human capital, and the increasing demand for the products offered.

To properly define the concept of "creative realm", we must start with the term "creativity" [7]. It is described otherwise via way of means of diverse fields of science. The creative sector generally provided services and products that could be associated with a precise artistic, cultural or recreational value. The modern financial system is entirely based on which promotes unique ideas, initiatives and values with innovative energy, imagination and knowledge. According to the World Intellectual Property Authority (WTO), the innovation zone includes all industries that manufacture, produce, present, display, distribute, broadcast, and promote items that may be hidden by the media. It consists of architecture, plans and art melody and new art, movies, radio, TV, writing and publishing, marketing, software, and virtual content [8].

The modern economy requires skilled workers who use the digital environment to support information research, critical thinking, creativity, and problem-solving. Most creative industry organizations are developing new ideas, knowledge, and methodologies for

---

<sup>122</sup> Tadulako University, Palu

<sup>123</sup> Tadulako University, Palu

commercial and practical products or services [9]. The innovative enterprise is carefully associated with knowledge-extensive sports and technological development. Knowledge introduction and innovation on this subject are on the coronary heart of the expert paintings of experts. Information, vital thinking, creativity and virtual era trouble fixing are precious assets. Therefore, this have a look at gives a overall performance check to degree those abilities at some point of virtual advertising withinside the innovative enterprise. This locating represents an vital breakthrough in elucidating distinct technical indicators. We argue that only by harnessing a systematic understanding of creativity can we uncover where and how risks, successes and failures are dominated by the media industry operating in increasingly entrepreneurial and neoliberal structures [10].

Our enjoy and know-how of the sector are an increasing number of being filtered through distinct layers of our virtual environment. Digital technologies, augmented truth, digital truth and associated generation abilities are continuously converting each thing of our social, cultural or monetary life [11]. Today's business world facing innovative, competitive and innovative technological advances. New technologies such as cloud computing, IoT, wearables, 5G, big data analytics, and 3D (3D) technologies are redefining approaches to enable all relevant stakeholders to respond quickly and efficiently do think again. They usually identify ways to overcome obstacles or solve specific problems. The growing interdependence between creative disciplines and technologies has led to new forms of artistic expression and entirely new art genres (new media art, digital art, video art, etc.). New understandings of creativity (museums, theaters, galleries, etc.). New materials, processes, and tools for creative industry practices. Development tools for new business models, digital marketplaces, consumer groups, sales channels, and products. This is a whole new way to promote and sell your app. New forms of interaction and collaboration between users and manufacturers. A new virtual community of creators and innovators new forms of creativity that do not depend on humans, such as computer creativity.

Governments, local, nearby and countrywide authorities, politicians and corporations are more and more spotting the critical position and capability of innovative industries selling innovation and increase throughout the economy (European Union Cultural Coordination Panel of Experts and Creative Industries in 2012). Industrial and considerable social alternate are mentioned throughout. How we get hold of news, pick out jobs and layout

paintings environments, have interaction with clients and stakeholders in product development, and the way those merchandise are consumed: Digital technology have a profound effect at the lives of each human beings and professions. The cause of this have a look at is to discover the position of virtual advertising and marketing withinside the upward thrust of the innovative industry.

## **Discussion**

With the development of technologies designed to optimize time and money for companies with rapid competition in the industry. One of the emerging industries is the creative industry. Based on the explanation in the introductory part, it is necessary to pay attention to the importance of the role of technology, especially digital marketing, in developing the creative industry in the new normal era. The role of the technology used can reduce the time and cost suffered by members of the creative industry. Therefore, members of the creative industry must be able to adapt to the times so that they can compete in uncertain situations such as the current era of epidemics.

Changes in business models were widespread. Product offerings have been transformed into pay-as-you-go services in video games as products distributed by publishers and retailers. Income models are undergoing rapid change. The new value proposition is supported by a new value allocation mechanism and value registration in the value architecture. Functional architectural changes are primarily related to infrastructure and customer relationships. This new business model has been tested by in several new games.

However, as the online gaming market grows exponentially, it becomes increasingly difficult for businesses to attract new customers. Cash flow problems arose due to a sharp decline in sales in a short period of time. This case highlights the different time frames required to evaluate the business model and the high risk of transforming the business model. In some cases, businesses have used unprofitable customer acquisition leader monetize related products and services. At major record labels, companies have radically changed their product offerings from music sales to live sales, merchandise and advertisements, selling merchandise and live performances to select artists, and offering free download music. He also experimented with the Payas you go model of the selected artist. With this model, a strong emotional connection between the artist and the fan allows the customer to decide how much to pay for themselves.

As a result, the company was able to increase sales while expanding its fan base. The sustainability and transferability of the model remains uncertain, but the initial economic benefits are very promising.

Some of the major case studies are using digital technology to transform their business models. However, the results are mixed, emphasizing the high risk. In the past, software companies have provided custom software to large customers. The software was developed and implemented at a higher price according to the customer's request, and after completion, the intellectual property (IP) was transferred to the customer. This feature allows the company to source project management software from industries key customers. This allowed the company to release a standardized version of its software and sell it to many new customers, creating an online hosting service for management large-scale projects. This has revolutionized the business model executives refer to as "service production," from selling individual services to specific customers to selling standardized products and services for multiple customers. Organizations can promote licenses a couple of instances to minimize replication costs and increase revenue. In addition, the new hosting service allows businesses to connect multiple customers over a long period of time (for example, 57 years for large construction projects), stabilize service revenues, and significantly improve a company's financial position. I can do it gain. The key to the success of the new business model is the customer broadband and 3G / 4G broadband. Business models are changing rapidly. Product offerings have changed from software developed for a single customer to standard products and hosted services that use the software for multiple customers. The profit model has changed to billing some customers for additional development costs and recurring services to charging multiple customers for recurring hosting in addition to licensing fees. The structure of values, especially the writing and recording of values, is fundamentally changing. In a functional architecture, non-standard products become standard and are also used to support hosting services. Necessary infrastructure to build and deploy hosting products and services is vastly different than ever before. Customer relationships change from managing individual relationships with a small number of large customers to managing full relationships with multiple customers.

The creative industries, in particular, have succeeded in supporting innovation by exporting creative methods to other

industries. This trend began in 2009 with the publication of two influential books. We have been very successful in driving innovation by exporting industries creative methodologies to other industries [6], [12].

The Internet can be a very useful tool for marketers to build strong brands and gain a competitive advantage [13]. However, to harness the power of the internet, businesses need to use social media as their channel to reach out to their customers. Revenue from stakeholder engagement eventually increased. As marketing communications become digital, marketers can use social media to create digital connections with their customers. You can create these links in two ways. Implement different types of social media interactions to (1) behave like a digital or interactive business, maintain or improve your use of digital marketing at a high level, or (2) do your best with digital marketing. The increase will lead to more positive interactions, stronger customer relationships and subsequent customer loyalty. Dynamic opportunity is defined as the ability to (1) identify and shape opportunities and threats (2) seize the opportunity it is decided advantage [14].

## **Conclusion**

The creative industries enable entrepreneurs to use cutting-edge technology and lead an intelligent life of. Creative organizations are developing into a dynamic and profitable sector of the domestic economy. Their main goal is to realize their creative potential. This is how human resources, cultural, social and institutional capital are combined. The creative sector is less prone to financial and economic crises than the 4,444 traditional sector. To grow your business, you need to get the most out of social media marketing. Communication with our community and our customers allows us to adapt our products to our customers' needs. Increasing attention to the creative industries brings not only intellectual benefits but also concrete benefits.

This work contributes to an understanding of business model theory and how digital technologies are used to drive innovation in business models. He also identified key trends in business model innovation, from brand extension to monopoly, personalization associations to dynamic pricing and payment models. These discussions also provide insights into the policies and practices of the creative industries and their role in promoting innovation and entrepreneurship in the high-tech and other economic sectors.



According to this article, in order to maximize the utility and value of technology in the creative industry, research on technology that surpasses it should be done in the future. This study will focus on future research to improve personalization, user experience, user engagement and engagement, online creativity (collaboration) and collaboration that maximize the creative industry by facilitating the use and value of technology content creation and automatic (online) creation, new optimized production methods, content consumption, storage and infrastructure, archiving and digital storage, content distribution/broadcasting, game collaboration and personalization, visual interfaces, multimedia holograms, and more. New and better digital rights management tools, as well as 3D Vision, 3D physical, VR/AR. Therefore, surrounding governments must expand the use of innovative industries to put pressure on monetary growth.

## Reference

- [1] V. Mangematin, J. Sapsed, and E. Schüßler, "Technological Forecasting & Social Change Disassembly and reassembly : An introduction to the Special Issue on digital technology and creative industries ☆," *Technol. Forecast. Soc. Chang.*, vol. 83, pp. 1–9, 2014, doi: 10.1016/j.techfore.2014.01.002.
- [2] C. Peukert, "and the cultural industries," *J. Cult. Econ.*, no. 0123456789, 2018, doi: 10.1007/s10824-018-9336-2.
- [3] C. B. Weinberg, C. Otten, B. Orbach, and J. Mckenzie, "Technological change and managerial challenges in the movie theater industry," *J. Cult. Econ.*, no. 0123456789, 2020, doi: 10.1007/s10824-019-09374-z.
- [4] O. Adebola, A. Oyekunle, and M. Sirayi, "The role of creative industries as a driver for a sustainable economy: a case of South Africa," *Creat. Ind. J.*, vol. 11, no. 3, pp. 225–244, 2018, doi: 10.1080/17510694.2018.1480850.
- [5] L. Carvalho and S. C. S. Cruz, "Creative industries in Brazil : on the measurement of their size and relative importance," *Creat. Ind. J.*, vol. 0, no. 0, pp. 1–20, 2017, doi: 10.1080/17510694.2017.1376173.
- [6] K. Fleischmann, R. Daniel, and R. Welters, "Developing a regional economy through creative industries: innovation capacity in a regional Australian city," *Creat. Ind. J.*, vol. 0694, no. March, pp. 1–21, 2017, doi: 10.1080/17510694.2017.1282305.
- [7] B. Wawrowski and I. Otolá, "Social Media Marketing in Creative Industries : How to Use Social Media Marketing to Promote

- Computer Games ?," 2020.
- [8] J. Rodgers, "Jobs for creatives outside the creative industries : a study of creatives working in the Australian manufacturing industry," *Creat. Ind. J.*, no. June, pp. 37-41, 2015, doi: 10.1080/17510694.2015.1034572.
  - [9] E. Van Laar, A. J. A. M. Van Deursen, J. A. G. M. Van Dijk, and J. De Haan, "Poetics Measuring the levels of 21st-century digital skills among professionals working within the creative industries : A performance-based approach," *Poetics*, no. December 2019, p. 101434, 2020, doi: 10.1016/j.poetic.2020.101434.
  - [10] S. Kerrigan *et al.*, "The systemic relationship between creative failure and creative success in the creative industries," *Creat. Ind. J.*, vol. 0, no. 0, pp. 1-15, 2019, doi: 10.1080/17510694.2019.1624134.
  - [11] M. Abbasi, P. Vassilopoulou, and L. Stergioulas, "Technology roadmap for the Creative Industries," *Creat. Ind. J.*, vol. 10, no. 1, pp. 40-58, 2017, doi: 10.1080/17510694.2016.1247627.
  - [12] C. Granados and M. Bernardo, "How do creative industries innovate? A model proposal," *Creat. Ind. J.*, vol. 0694, no. November, 2017, doi: 10.1080/17510694.2017.1393192.
  - [13] M. Teresa, P. Melo, B. Tiago, and M. Cristo, "Digital marketing and social media : Why bother ?," 2014, doi: 10.1016/j.bushor.2014.07.002.
  - [14] D. J. Teece, "Explicating dynamic capabilities: the nature and microfoundations of (sustainable) enterprise performance," vol. 1350, no. February 2004, pp. 1319-1350, 2007, doi: 10.1002/smj.



## EMBRACING SOCIETY 5.0 WITH HUMANITY

Society 5.0 is a concept presented by the Japanese as a core concept of their economic system. They believed that technology should not surpass the intelligent of men. As such, in society 5.0 the Japanese government would like to ensure that all technological things are designed to be a human-centered design. In fact, their ministry of education in 2018 has also been readily prepared the future generation through a change in their education system. For example, the minister explains that in Japan, or many parts of the world, university entrance are divided into two main concentrations, which are science and social science. The minister thought of changing the system, as society 5.0 is about creating a technology that is human centered. For instance, they gave an example on designer babies. If, people from hard science learn about philosophy, ethics, and humanities, they won't face such ethical concern when developing a product. This is what is being envision by the Japanese government for their younger generation. Collaboration between science and social science is necessary to build a better environment for our future children. Another example is the companies in Japan, such as Hitachi and Fujitsu has already been implementing this 5.0 by designing product that relied fully on technology but puts human at its center (Hitachi, 2017).

Likewise, it is currently a hot topic in Indonesia. Indonesia as a country with the 4th largest population in the world has not been implemented this concept. Our country is still on the industry 4.0. Yet, with the rising interest in AI, Blockchain, NFT, number of unicorn start-up, and all recent technological changes, our country are ready to compete with any other countries in Southeast Asia. Society 5.0 is coming, and we need to embrace it. To prepare with the society 5.0, It is not only the technological side. It is necessary for us to have a strong principle at hearts that based on our belief system. We, as an Indonesian have known to be religious that most of us believed in God. We also commonly practice our religion and tend to be kind to people because we know God would love our good deeds. I personally think that this will help us to move forward and live together with advanced technology.

Technology begets a very important leap in human's life journey. It is important to keep valued of the benefit but it's more important to look out for the human itself. As its purpose is smarter than us, to help us, it will be very ideal if we embrace the technology using our ability to be kind.

**Bildung**

- 📞 +6281227475754
- 📘 Bildung
- 📧 @sahabatbildung
- ✉️ bildungpustakautama@gmail.com
- 🌐 www.penerbitbildung.com

ISSN 978-623-6225-67-7



9 786236 225677

